

# ACOM



## ACOM 1500

HF + 6m  
Linear Amplifier

User's Manual

Installation, Operation  
and Maintenance

**OUTSTANDING HF POWER PRODUCTS**

August 2021

This manual is for electronic distribution mainly.  
If you have it on paper and you no longer need it, please, recycle it!

The latest versions of our User's Manuals are available at  
[www.acom-bg.com](http://www.acom-bg.com)

## ABOUT DOCUMENTATION

All ACOM documentation (including manuals, brochures, specifications, descriptions, presentations, video materials, etc.) are based on the latest available information at the time of creation of our documents.

As we always strive to constantly improve and update our products, ALL PRODUCTS, PRODUCT SPECIFICATIONS AND DATA ARE SUBJECT TO CHANGE. ACOM reserves the right to make changes and improvements at any time without further notice or obligation to notify any person or organization of such revisions or changes, made in order to improve the reliability, function, quality and design, and/or performance of the ACOM products and services.

Further, this User's Manual is provided AS IS and ACOM shall not be liable for possible errors contained herein.

This manual supersedes all previous editions, which thereby become invalid.  
The cover images used in the manual are illustrative only.

We are continuously striving to improve our documentation, but nobody is perfect.  
And our documentation is not an exception of this rule.  
Have you found any errors or would you like to suggest changes in our documentation?  
Please help us by sending your suggestions to the following e-mail address:  
[documentation@acom-bg.com](mailto:documentation@acom-bg.com)

The latest versions of our User's Manuals are available at  
[www.acom-bg.com](http://www.acom-bg.com)

We highly recommend you to use this manual in electronic form as PDF-file instead of printed version. The PDF-file is easy to read on any computer, tablet, smart phone or other similar device. In the PDF file you will find the necessary information very fast due to context-oriented links (marked in *orange*) inside the file, including context-linked Table of Content.

To open PDF-files you can use any free PDF viewer, for example:

- Adobe Acrobat Reader DC (<https://get.adobe.com/reader>);
- Foxit Reader (<https://www.foxitsoftware.com/pdf-reader>);
- Your web browser. Web browsers like Google Chrome, Firefox and Safari all have integrated PDF readers.

**Title of Documentation** ACOM 1500 HF + 6 m Linear Amplifier  
User's Manual  
Installation, Operation and Maintenance

**Type of Documentation** User's Manual

**Purpose of Documentation** This manual explains Installation, Operation and Maintenance of the ACOM 1500 HF + 6 m Linear Amplifier.

Record of Revisions	Description	Release Date	Notes
	ACOM 1500 User's Manual	-	First edition
	ACOM 1500 User's Manual	-	Second edition
	ACOM 1500 User's Manual	17.04.2016	Third edition
	ACOM 1500 User's Manual	28.08.2020	Fourth edition
	ACOM 1500 User's Manual	13.08.2021	Fourth edition, R02

**Validity** The specified data is for product description purposes only and may not be deemed to be guaranteed unless expressly confirmed in the contract. All rights are reserved with respect to the content of this manual and the availability of the product.

**Copyrights** © 2021 ACOM Ltd.  
Copying this document, giving it to others and the use or communication of the contents thereof without express authority, are forbidden. Offenders will be held liable for infringement of any intellectual property of ACOM Ltd. and all damages which may rise as a result.

**Published by** ACOM Ltd.  
Bulgaria | Bozhurishte 2227  
Sofia-Bozhurishte Economic Zone | 6 Valeri Petrov Str.  
GPS coordinates: 42.748616° | 23.209801°  
Web: [www.acom-bg.com](http://www.acom-bg.com)  
E-mail: [documentation@acom-bg.com](mailto:documentation@acom-bg.com)

**Note** This manual has been printed on chlorine-free bleached paper.

## Contents

- ABOUT DOCUMENTATION ..... 3
- 1. GENERAL INFORMATION ..... 7
  - 1.1. Introduction and Description ..... 7
  - 1.2. Owner Assistance ..... 8
  - 1.3. Equipment Supplied ..... 8
  - 1.4. Features..... 8
  - 1.5. Safety Considerations, Explicit Definitions..... 10
- 2. INSTALLATION..... 13
  - 2.1. Unpacking and Initial Inspection ..... 13
  - 2.2. Line Voltage Selection ..... 13
  - 2.3. Amplifier Location Selection ..... 14
  - 2.4. Connections..... 15
  - 2.5. Installation of External Fan (option)..... 19
- 3. POWER ON, CONTROLS AND INDICATORS ..... 20
- 4. OPERATION ..... 23
  - 4.1. Turning ON and OFF ..... 23
  - 4.2. Changing OPERATE and STANDBY Modes..... 24
  - 4.3. Antenna Change ..... 25
  - 4.4. Tuning..... 25
  - 4.5. Continuous Carrier Modes ..... 29
  - 4.6. ON LINE Information Screens and Control Functions ..... 30
  - 4.7. Auto-Protection System ..... 30
- 5. OFF LINE MODE ..... 32
  - 5.1. Display Brightness Control ..... 32
  - 5.2. Auto-Operate Enabling and Disabling ..... 32
  - 5.3. Antenna Output Assignment..... 33
  - 5.4. Reading Auto-protection Signatures..... 33
- 6. MAINTENANCE ..... 34
  - 6.1. Periodic Maintenance ..... 34
  - 6.2. Cleaning..... 35

- 6.3. Fuse Replacement ..... 35
- 6.4. Tube Replacement ..... 37
- 6.5. Simplified Schematic Diagram..... 38
- 6.6. Troubleshooting ..... 40
- 7. SPECIFICATIONS..... 42
  - 7.1. Parameters ..... 42
  - 7.2. Functions ..... 44
  - 7.3. Storage and Shipment..... 45
    - 7.3.1. Storage Environment..... 45
    - 7.3.2. Shipping Size and Weight ..... 45
    - 7.3.3. Transportation ..... 45
    - 7.3.4. Returning to the Service Provider ..... 45
  - 7.4. Information on Disposing and Recycling of Old Electrical and Electronic Equipment ..... 46
- NOTES ..... 47

**Figures**

- Figure 2-1 Rear panel - Connections ..... 15
- Figure 2-2 External fan ..... 19
- Figure 3-1 Front panel - Display and Controls..... 20
- Figure 3-2 Information screens and control functions structure ..... 21
- Figure 4-1 Using TRI tuning aid..... 28
- Figure 6-1 Simplified schematic diagram ..... 39
- Figure 7-1 Packaging cardboard box ..... 45

**Tables**

- Table 2-1 Amplifier individual data ..... 13
- Table 4-1 Approximate tuning presets..... 27

## 1. GENERAL INFORMATION

Congratulations on purchasing one of the finest HF amplifiers in the world today.

ACOM is pleased that you have chosen one of our products, and we will endeavor to provide you with the information and support you need to enjoy your purchase for many years.

We urge you to read all of the following materials before you embark on operating your new amplifier.

### 1.1. Introduction and Description

This manual explains:

- Installation
- Operation and
- Maintenance

of the ACOM 1500 HF + 6 meter linear amplifier.

The ACOM 1500 is a complete and self-contained linear amplifier that covers all amateur bands from 1.8 through 54 MHz and provides over 1500 W PEP (1200 W continuous carrier) output power with less than 85 W exciter drive. Antenna SWR up to 3:1 is acceptable with 1200 W forward power. Tuning is substantially simplified by a plate-load True Resistance Indicator (TRI) and by an automatically controlled input attenuator. Operating parameters are displayed by a multi-functional high brightness OLED display. Full break-in transmit/receive switching (QSK) is standard.



## 1.2. Owner Assistance

If assistance is needed, you should contact your local dealer first. If necessary, your dealer will contact ACOM for additional guidance.

If you still have an issue you need to discuss with one of ACOM's specialists, the contact information is as follows:

ACOM Ltd.

E-mail: [support@acom-bg.com](mailto:support@acom-bg.com)

Bulgaria | Bozhurishte 2227

Sofia-Bozhurishte Economic Zone | 6 Valeri Petrov Str.

GPS coordinates: 42.748616° | 23.209801°

## 1.3. Equipment Supplied

The ACOM 1500 amplifier and this User's Manual are shipped in a cardboard carton.

## 1.4. Features

- **Easy to operate**  
The TRI (True Resistance Indicator) is a powerful tuning aid which, together with the automatically controlled input attenuator, helps the operator to quickly and precisely match the antenna impedance to the optimum tube load impedance (5-10 seconds typically). The auto-operate function (when enabled) maintains the amplifier in the OPERATE mode for you, thus saving manual operations and time.
- **No antenna tuner needed**  
No heavy outboard antenna tuners required for antenna SWRs up to about 3:1. Your amplifier will enable you to change antennas virtually instantaneously and allow you to use your antennas over wider frequency ranges.
- **User-friendly and durable**  
An amplifier that is both user-friendly and that looks after itself. It is designed to safely withstand up to 300 W reflected power, up to 100 milliseconds duration of drive spikes, drive RF "tails" after a PTT or KEY release, operator's inadvertent tuning errors etc. The amplifier also will not cease to function with a "soft" AC mains and will deliver more than half power at only 85% of nominal mains voltage. It can withstand voltage drops (down to zero Volts) for up to 10 milliseconds and can tolerate 15% mains voltage spikes, which is especially important on Field Day, during DXpeditions, and at portable operating events where emergency power is relied upon.
- **OLED comment display**  
All amplifier status indications are explained via detailed text displayed on the OLED (Organic Light Emitting Diode) Display. The upper line on the OLED display always reads peak forward power. LED indicators are provided for: OPERATE mode, attenuation-on (ATT), transmit (TX), selected antenna output (1, 2, or 3), and ON/OFF conditions.
- **Easy antenna selection**  
Three antenna outputs are selectable using a push-button on the front panel.



- **Easy maintenance**  
Signatures of the amplifier internal status are stored in a nonvolatile memory for 7 most recent auto protection trips. This information can be forwarded to your dealer for diagnostics. Using an EXCEL application (available from ACOM or your dealer free of charge) and a PC you can decode the signatures by yourself, too.
- **Less noise in the shack**  
The input bypassing and the vacuum antenna relays are virtually silent even in the QSK CW mode due to their special mounting.
- **Efficient tuning**  
Less QRM and improved Electro Magnetic Compatibility during tuning. Amplifier tuning can be achieved in less than 10 seconds at a quarter of nominal output power.
- **Transceiver-independent**  
The amplifier operates without special signals from the transceiver - "Ground on TX" (PTT) and 85 W RF drive power are sufficient.
- **Broadband input matching**  
Broadband input matching circuit design provides excellent transceiver loading over the entire spectrum, from 1.8 MHz up to 54 MHz.
- **Single tube operation**  
Uses a single 4CX1000A/8168 ceramic and metal radial beam tetrode with plate dissipation of 1000 W (forced air cooled, grid-driven), which is specifically designed for class AB1 RF linear amplifier operation.
- **Tube protection**  
Permanent monitoring includes protection of plate and grid voltages and currents, as well as exhaust air temperature. The Bias Optimizer decreases the heat dissipated from the tube, and there is automatic protection against overheating in accordance with specifications of the tube manufacturer.
- **Output RF arc protection**  
Output RF arc protection is employed. This important feature safeguards the amplifier, antenna, antenna selector, and tuner against severe damage in case of possible breakdown.
- **High voltage protection**  
High voltage power supply inrush current limitation. This feature reduces the risk to sensitive devices connected to the same mains circuit (important when used portable) when the amplifier is turned on. Moreover, the amplifier can be configured for 8 different nominal line voltages: 100, 110, 120, 200, 210, 220, 230, or 240 VAC, 50 or 60 Hz.
- **Continuous monitoring and/or selectable measurement**  
Continuous monitoring and/or selectable measurement of the 12 most important parameters of the amplifier, exciter, and the selected antenna via the OLED display.

### 1.5. Safety Considerations, Explicit Definitions

The ACOM 1500 HF + 6 meters Linear Amplifier is a Safety Class I unit regarding protection against electric shock. The third grounding lead of its mains cord (colored yellow with two green stripes) and the ground stud on the rear panel of the amplifier (marked **GND**, see [Figure 2-1 Rear panel - Connections](#), Pos. (a)) must be connected to the station's grounding system for safe operation.

The amplifier is designed to meet international safety standards and complies with CE safety and electromagnetic compatibility requirements, as well as FCC regulations.

This User's Manual contains information, warnings (signal words **Danger**, **Warning**, **Caution** and **Notice**) and instructions, related to hazards, that should be followed by the user in order to ensure safe operation and to keep the amplifier in a safe working condition at all times.

The EXPLICIT DEFINITIONS described below apply to this User's Manual:

#### **DANGER**

*These notes call attention to a procedure or instructions which, if not correctly performed, **will result in serious personal injuries and even death.***

#### **WARNING**

*These notes call attention to a procedure or instructions which, if not correctly performed, **could result in serious personal injuries and even death.***

#### **CAUTION**

*These notes call attention to a procedure or instructions which, if not correctly performed, **could result in minor or moderate personal injuries.***

#### **NOTICE**

*These notes call attention to a procedure or instructions which, if not correctly performed, **could result in property damage or equipment damage not exclusively to the amplifier but also to connected equipment.***

Information notes described below apply to this User's Manual:



*These notes highlight operating procedures or practices that may improve equipment reliability and/or personnel performance, or to emphasize a concept.*

**ORANGE TEXT as LINKS**

*marks all internal links in the document between Sections, Figures, Tables, etc. for your convenience.*



The safety instructions contained in this User's Manual feature specific signal words (**Danger**, **Warning**, **Caution** or **Notice**) and, where required, a safety alert symbol, in accordance with actual standards ISO 3864 or ANSI Z535.

**PRECAUTIONS:****⚠ DANGER**

The amplifier works with high voltages up to 3000 V, which are LETHAL!

For your safety, pull the amplifier power plug out of the mains wall outlet and WAIT AT LEAST 30 minutes EACH TIME BEFORE you remove the cover of the amplifier. Do not touch any part inside while the amplifier is open because some residual voltages may still be present.

**⚠ DANGER**

Never allow anyone, ESPECIALLY CHILDREN, to push or put anything into holes in the case - this will cause electric shock. NEVER TOUCH AN ANTENNA or antenna insulators during transmission or tuning - this may result in an electric shock or burn. NEVER EXPOSE the amplifier to rain, snow or any liquids. AVOID placing the amplifier in excessively dusty environments or in direct sunlight. DO NOT OBSTRUCT AIR INTAKE (rear panel) and EXHAUST (top cover) areas of the amplifier. Keep a minimum clearance distance of 10 cm (4 inches) to the intake and 50 cm (20 inches) above the exhaust opening.

**⚠ WARNING**

Do not undertake on your own repairs or changes in hardware or software of the amplifier in order not to endanger your or other's health and life and not to damage the amplifier and the equipment connected with it, not covered by warranty. The manufacturer is not liable for another's actions and responsibility shall be assumed by the doer.

**⚠ WARNING**

To avoid damage (not covered under warranty) read the Section **2 INSTALLATION** of this User's Manual carefully. If you have any doubts about the installation, operation or safety of the amplifier, please, consult your dealer.

## 2. INSTALLATION

### 2.1. Unpacking and Initial Inspection



Before you install your amplifier, thoroughly read this manual.

First, carefully inspect the cardboard carton and its contents for physical damage. ACOM ships amplifiers in highly protected containers, but it cannot assure that mistreatment by shippers will not occur. If damage is evident, notify your dealer immediately. Delay may void the carrier's warranty.

Keep all packing materials for possible future amplifier shipment (see Section [7.3.4 Returning to the Service Provider](#)).

### 2.2. Line Voltage Selection

#### NOTICE

In order to avoid any damage (not covered by the warranty), check carefully to be certain that the voltage for which the amplifier is set corresponds to your mains nominal voltage.

Normally, the amplifier is supplied set for a nominal line voltage of 240 V. If your mains voltage is not 240 V, you must contact your dealer for instructions. The only exception to this is if the unit has been custom ordered, in which case the voltage selection will be noted in the Table of Individual Data (see [Table 2-1 Amplifier individual data](#)).

AMP SN:	
Tube SN:	
Voltage Selector Position	VAC

Table 2-1 Amplifier individual data



The amplifier power supply can be configured for 8 different nominal line voltages: 100, 110, 120\*, 200, 210, 220, 230, or 240 VAC, 50 or 60 Hz.

\* Note the limitation for 100/120 VAC operation in Sections [7.1.b\) Power Output](#) and [7.1.i\) Mains Power Consumption](#).

### 2.3. Amplifier Location Selection

#### **⚠ CAUTION**

The weight of the unit is about 26.5 kg (58.5 lbs.), which should preferably be handled by two persons.

Position the amplifier near the place where it will be used. You will need an easy access to the command knobs and indicator's area, as well as to the rear panel cabling.

No magnetic-field sensitive devices (such as microphones) should be located next to the right side of the amplifier because its power transformer is located there. It is advisable to position the amplifier to the right of your transceiver.

No temperature-sensitive devices should be located above the exhaust hot air area. This means that the amplifier should not be located under a shelf or other structure that could impede the free movement of air away from the amplifier. You may prefer to use the bottom scales of both variable capacitor knobs (**TUNE** and **LOAD**) if you install it on a shelf.

#### **NOTICE**

Do not under any circumstances obstruct the air intake (rear panel) or exhaust (top cover) areas of the amplifier. Keep a minimum clearance distance of 10 cm (4 inches) from the intake and 50 cm (20 inches) from the exhaust openings.

#### **NOTICE**

Do not leave accidental paper, cloth or other lightweight pieces around and under the amplifier. They may be drawn in by the cooling air stream and block the vents. This will lead to overheating and accelerated material aging, not covered by the warranty.

## 2.4. Connections

Please, see **Figure 2-1 Rear panel - Connections**.

Connection to your station must be accomplished in the order described below, before you apply mains voltage to the amplifier.



Before you connect the amplifier to external grounding, you should advise with a licensed electrician and confirm such kind of connection is allowed by your national and local electrical code, safety rules, and regulations in force. Simultaneous connection to the earth grounding and protective earth may be inadmissible or may fall under special requirements in some countries!

### **⚠ DANGER**

Never use the gas installation for grounding. This can cause an EXPLOSION!

### **⚠ DANGER**

Do not use the steam-heating or water-supply network for grounding! You may expose to dangerous voltage not only yourself but also other people using the same installation.

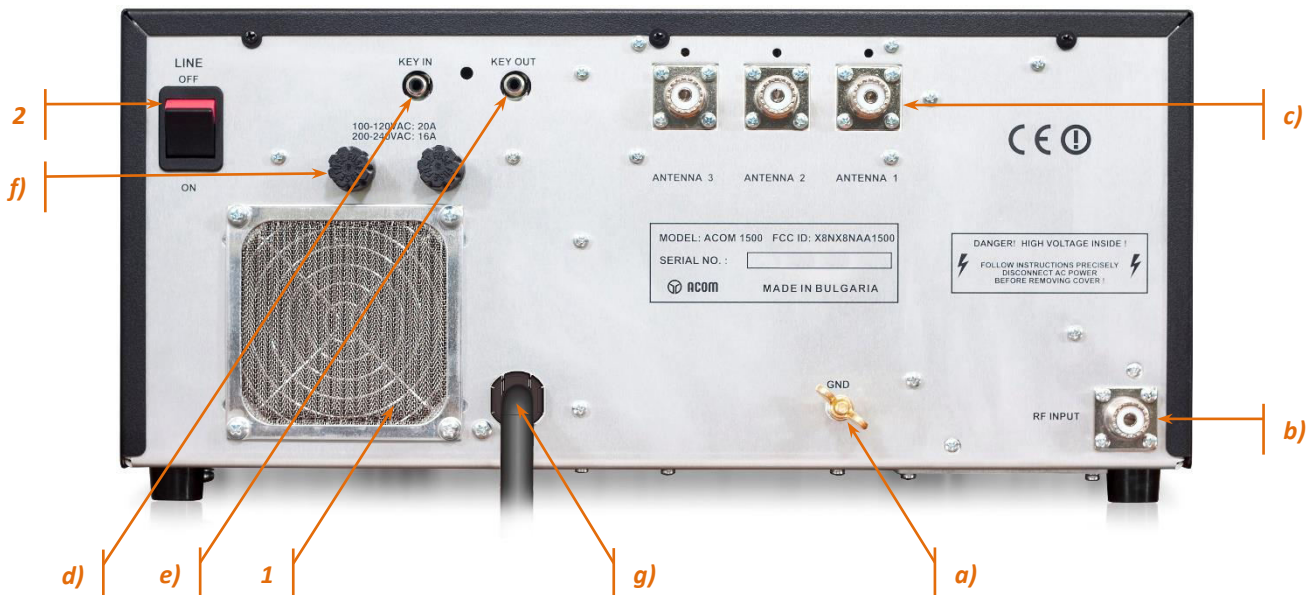

Figure 2-1 Rear panel - Connections

a) **GND** stud

First, connect the wing-nut ground stud of the amplifier (on the rear panel, marked **GND**) to the station's grounding system (see *Figure 2-1 Rear panel - Connections*, Pos. (a)).

**⚠ WARNING**

Note that the grounding system may have to withstand currents over 20 A with insignificant voltage drop on it. Therefore, it may be necessary to improve it considerably, i.e., to become less resistive, with heavier leads and lower-resistive ground path. The grounding leads should be at least 8 mm<sup>2</sup> (AWG 8 or SWG 10).

b) **RF INPUT** socket

Connect a suitable coaxial cable from the transceiver output to the amplifier **RF INPUT** SO-239 socket (see *Figure 2-1 Rear panel - Connections*, Pos. (b)), using PL-259 plug.

**NOTICE**

In order to avoid a damage, turn off your transceiver's internal antenna tuner.

c) **ANTENNA 1, ANTENNA 2, and ANTENNA 3** sockets

**NOTICE**

If this is the first time you will use a power amplifier in your station, pay attention to the coaxial cable type from the amplifier's three outputs to the antennas. It must handle the increased power safely, particularly on the 10- and 6 meters bands. We recommend that you use RG213 cable or better. Check the same for the antenna selector and tuner as well as the antenna system.

Connect a suitable coaxial cable with a PL-259 plug (with PTFE insulation) from the appropriate amplifier output (marked **ANTENNA 1, ANTENNA 2, and ANTENNA 3**, see *Figure 2-1 Rear panel - Connections*, Pos. (c)) to the antenna selector or tuner, or to the antenna for the respective frequency band.

d) **KEY-IN** socket

This is the amplifier's input for receive/transmit control from the transceiver.

The transceiver controls the amplifier from receive mode into transmit mode (RX/TX) by grounding of the **KEY-IN** input.



Run a shielded cable from the "ground on transmit" socket or terminal on your transceiver to the amplifier **KEY-IN** socket (see [Figure 2-1 Rear panel - Connections](#), Pos. (d)). The **KEY-IN** socket uses a standard RCA phono plug.



The switching voltage presented from amplifier **KEY-IN** socket to the transceiver "ground on transmit" output does not exceed 14 V (positive to the ground). The closed-circuit current is below 8 mA.



Your amplifier will not work if **KEY-IN** input is not connected properly.

Transceiver producers give different names to this output and they are for instance TX-GND, SEND, T/R-LINE, PTT, etc. Some transceivers require that "ground on transmit" is implemented via a software command, or by changing the setting of a switch on the rear panel, or interior of the transceiver. Check your transceiver's manual.

e) **KEY-OUT** socket

This is the amplifier's transmit-enabling control output to the transceiver.

The **KEY-OUT** socket (see [Figure 2-1 Rear panel - Connections](#), Pos. (e)) provides an extra control signal from the amplifier to the transceiver. It could be used to improve the transmit/receive (RX/TX) switching safety.

### NOTICE

**KEY-OUT** is a low-power open-drain output, make sure that the signal voltage coming from the respective transceiver connection does not exceed 50 VDC (open circuit) and the closed-circuit current is below 20 mA.

If your transceiver has a suitable input that disables transmission unless grounded externally, we recommend that you connect it with a shielded cable terminated in a Phono (RCA) connector to the **KEY-OUT** socket of the amplifier.



ACOM 1500 will operate normally with **KEY-OUT** unconnected if your transceiver has no such input.

Transceiver producers give different names to this input and they are for instance TX-INHIBIT, MUTE, LINEAR, etc. Check your transceiver's manual.

## f) Main fuses

**NOTICE**

Make sure you check whether the main fuses installed in your amplifier (see *Figure 2-1 Rear panel - Connections*, Pos. (f)) correspond to your local mains nominal voltage and if necessary, replace them as described in Section *6.3 Fuse Replacement*!

**⚠ WARNING**

If your amplifier is only fitted with one line (mains) fuse, it is suitable for European Community ONLY. Your dealer will check that your amplifier is correctly fused before it is shipped to you. Customers should check with a qualified electrician if the amplifier is to be used outside the country in which it was purchased.

## g) Power cord

Due to the different standards in different countries, the mains plug is supplied and mounted by the dealer. He connects to the mains cord end (see *Figure 2-1 Rear panel - Connections*, Pos. (g)) a standard mains supply plug which meets the Safety Class I unit standard in your country.

The ground lead of the amplifier's power cord is colored yellow with two green stripes and the blue and brown leads are active. When the amplifier is to be used with only one mains fuse, it is connected in series with the brown lead, which must be the active. If you have any doubts about the correct way of connecting the wires, consult your dealer.

## h) Preparation of wall outlet

**⚠ WARNING**

Before connecting the amplifier to your mains supply using a licensed electrician, check that the supply is correctly wired, and is adequate for power consumption up to 3500 VA. Make certain that the grounding lead is connected properly and that it has a cross section not less than the cross section of the phase conductor in the wall outlet for the amplifier.

It is preferable that you use the wall outlet closest to the source. The installation leads should be at least 2.5 mm<sup>2</sup> (AWG 13 or SWG 15) at operating 200-240 VAC or 100-120 VAC, (recommended values if there are no stricter requirements by your local standard).

Check that the panel fuse has a free capacity for the additional load from the amplifier as specified in Sections *6.3 Fuse Replacement* and *7.1.i) Mains Power Consumption*. If you connect the amplifier to a different mains outlet, be sure that you check it, too.

Make sure the main Power Switch (marked "LINE", see [Figure 2-1 Rear panel - Connections](#), Pos. (2)), on the rear panel is in OFF position and insert amplifier's mains plug into the wall outlet prepared for it. The amplifier remains switched off.

## 2.5. Installation of External Fan (option)

This fan (see [Figure 2-2 External fan](#)) is not necessary in SSB and CW modes, nor in continuous carrier modes (RTTY, SSTV, etc.) with carrier down times of maximum 15 minutes and a subsequent pause of 3 minutes.

For higher duty cycles such as continuous broadcast or increased ambient temperatures the fan is recommended. The auxiliary fan (92x92 mm) must be brushless type, 2...5 W, 24 VDC. It may be installed by your dealer or by the manufacturer on request.



Figure 2-2 External fan

### 3. POWER ON, CONTROLS AND INDICATORS

**NOTICE**

Do not turn the amplifier on for at least 2 hours after unpacking it in the room where it will be used. Pay particular attention when you move it from a very cold into a warm place - condensation is likely and this could result in damage to the high voltage circuits. In such a case, wait at least 4 hours. A similar effect can occur after a rapid warming of the operating room (for instance after switching on a powerful heater in a cold shack).

**NOTICE**

In order to avoid any damage (not covered by the warranty), check carefully to be certain that the voltage for which the amplifier is set corresponds to your mains nominal voltage (see Section **2.2 Line Voltage Selection** and **Table 2-1 Amplifier individual data**).

After following all instructions in Section **2 INSTALLATION**, you may turn on the main power switch (marked "LINE") on the rear panel (see **Figure 2-1 Rear panel - Connections**, Pos. (2)). The LED indicator above the **POWER** button (located on the front panel) must light red and "ACOM 1500" will appear on the display (see **Figure 3-1 Front panel - Display and Controls**).



Figure 3-1 Front panel - Display and Controls

You will note that the upper line of the display always reads the peak forward power, even in STBY mode. The scale resolution is 15 W per bar. Note also that levels below 20 W may be not detected.

In this position (called OFF LINE hereafter), only the micro-controller is operational, while the amplifier itself is still turned off (and the tube is not powered at all).



If the characters on the fluorescent display (VFD type - obsolete since 2015) are dim, please, see Section **5.1 Display Brightness Control** (not operative in units furnished with OLED display).

The control of the amplifier is accessible during OFF LINE and ON LINE states, each having several information screens and control functions (see **Figure 3-2 Information screens and control functions structure**):

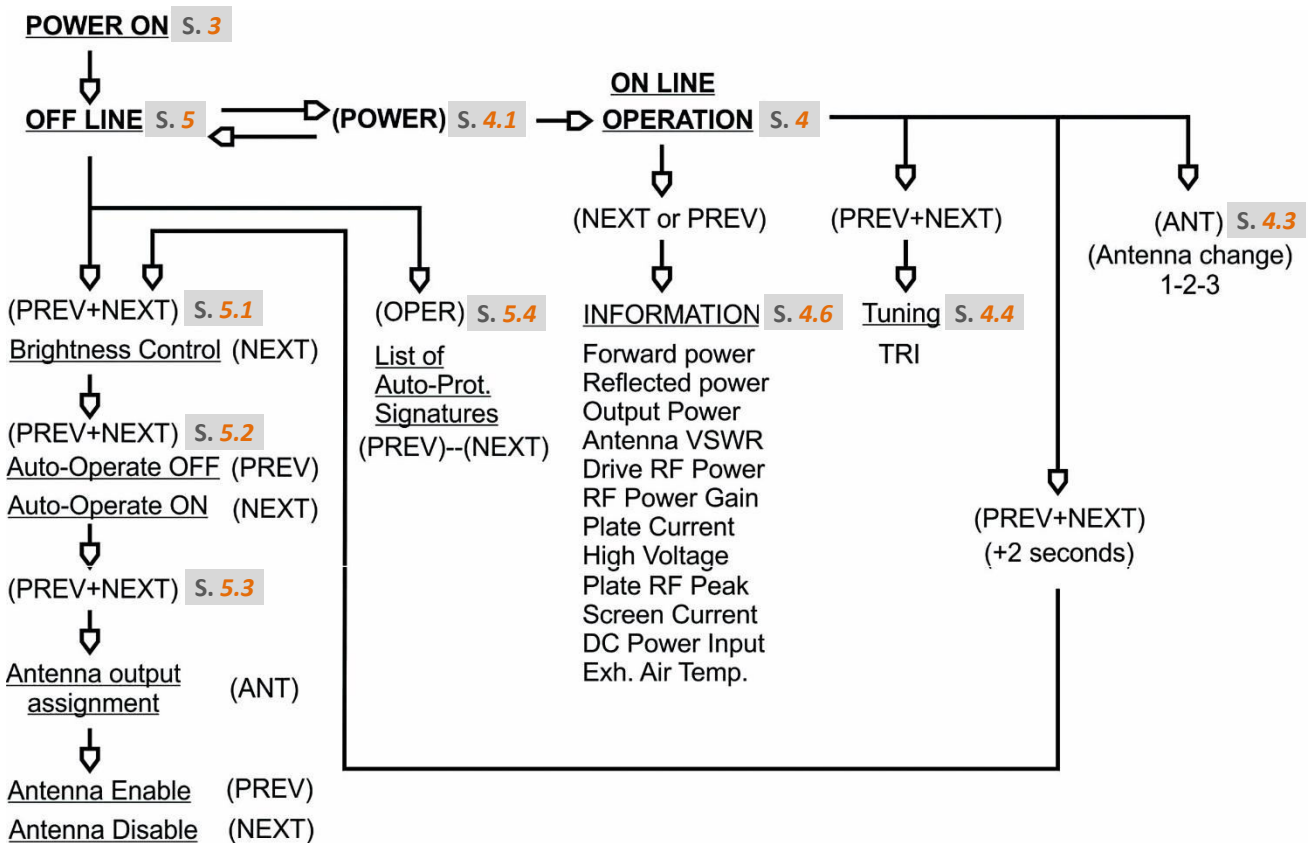

Figure 3-2 Information screens and control functions structure

The **OPER** button alternatively switches OPERATE and STANDBY modes while ON LINE (see Section **4.2 Changing OPERATE and STANDBY Modes**). Please, note that AUTO-OPERATE might be enabled (see Section **5.2 Auto-Operate Enabling and Disabling**). The **OPER** button activates signature list while OFF LINE (see Section **5.4 Reading Auto-protection Signatures**).

The **PREV** and **NEXT** buttons change information screens or select control functions for both OFF LINE and ON LINE states (see Section **4.6 ON LINE Information Screens and Control Functions**).

The **POWER** button alternatively switches OFF LINE and ON LINE states of the amplifier.

You can proceed in one of two directions:

- a) You can use the OFF LINE information screens and control functions. They refer to the auto-protection signatures list, Display brightness control, as well as the AUTO-OPERATE feature and Antenna assignment. This is described in Section **5 OFF LINE MODE**.
- b) You can turn on the amplifier and start the warm-up sequence. After 3 minutes you may tune and begin operating the amplifier and you can use the ON LINE information screens or control functions (see Section **4 OPERATION**).

## 4. OPERATION

Operation of the amplifier is simplified due to the TRI (True Resistance Indicator) tuning aid, AUTO-OPERATE function, and Automatic Protection System, so you will be able to begin using the amplifier immediately after the installation.

However, to make full use of the amplifier's potential and to fully configure it to your local conditions, we recommend that you thoroughly read the following information.

There are 14 ON LINE information screens, which can be selected by pressing repeatedly the **NEXT** or **PREV** buttons (see [Figure 3-2 Information screens and control functions structure](#)). Their purpose and method of use are described in the next Sections [4.1 Turning ON and OFF](#) through [4.7 Auto-Protection System](#).

### 4.1. Turning ON and OFF

In order to turn on the amplifier, while the Main Power Switch (located on the rear panel and marked "LINE", see [Figure 2-1 Rear panel - Connections](#), Pos. (2)) is in On position, press the **POWER** button (located on the front panel right-bottom corner, see [Figure 3-1 Front panel - Display and Controls](#)) and hold it on for about one second. The LED indicator above the **POWER** button will change the color from red to green. You will hear the blower and the optional external fan (if installed) start first at high speed, then slow down.

After successfully passing the initial self-tests, the LED indicator above **POWER** button begins flashing green while the following inscription on the display remains lit:

**WARMING UP: nnn s**

(**nnn** above is the number of seconds remaining to readiness for operation)

A tube warm-up period of 3 minutes follows. During this time the amplifier remains in STANDBY mode, so you can continue operating with the transceiver.

Pressing either the **PREV** or **NEXT** buttons during this period will result in changing the screen to one of the 14 available information screens described in Section [4.6 ON LINE Information Screens and Control Functions](#). This action will not influence the warming-up process, so you may pass through all information screens, for instance to monitor the High Voltage value or the Exhaust Air Temperature. You can also return to the earlier screen to see how many seconds are still needed until the tube cathode reaches its operating temperature.



When you intend to have a short operating break, it is better to leave the amplifier in STANDBY mode instead of turning it off. Tube life is shortened by repeatedly turning on and off the tube heater supply.

However, if you unintentionally power-off the amplifier, it is best to switch it on again immediately. When the pause is short (up to one minute) and the cathode is still warm, the warm-up period is shortened significantly, which reduces the waiting time and prolongs the tube's expected life.

After the indicated period expires, the LED indicator above **POWER** button stops flashing and lights green constantly. If the AUTO-OPERATE function is selected to ON (see Section [5.2 Auto-Operate Enabling and Disabling](#)), the green **OPER** LED lights too. The last used (one out of 14) information screen appears on the display, for instance:

"WARMING UP: Ready".

The bar graph on the upper line always indicates the peak forward power (as well as during OFF LINE).

In order to turn the amplifier OFF press shortly the **POWER** button. If you are not going to use the amplifier for a long time, it is best to turn it off using the Main Power Switch (located on the rear panel and marked "**LINE**") as well.

## 4.2. Changing OPERATE and STANDBY Modes

With the AUTO-OPERATE function disabled (see Section [5.2 Auto-Operate Enabling and Disabling](#)), the **OPER** button changes two modes alternatively.

When AUTO-OPERATE is enabled, the amplifier will be maintained to OPERATE mode by default, unless you use the **OPER** button manually to go to STANDBY mode (then AUTO-OPERATE is suppressed temporarily). Pressing **OPER** again would restore the AUTO-OPERATE feature.

When the AUTO-OPERATE function is disabled (see Section [5.2 Auto-Operate Enabling and Disabling](#)), the amplifier will shift and stay in STBY mode after each protection trip. To restore operation, the **OPER** button must be depressed.

When the AUTO-OPERATE function is enabled, the amplifier will shift to the STBY mode on a protection trip. It will return to the OPER mode after about four seconds automatically.



### 4.3. Antenna Change

By pressing the **ANT** button, the amplifier output can be switched between three antenna outputs. The three lights above the button indicate the current antenna selection.

#### **NOTICE**

To avoid damage (not covered under warranty) do not change antennas while transmitting. Do not transmit into an antenna output (1, 2, or 3) if it is not connected to an antenna or a dummy load.

#### **NOTICE**

Selection of any of the antenna outputs can be disabled if not used (see Section [5.3 Antenna Output Assignment](#)). This prevents inadvertent selection of unused antenna outputs, preventing no-load transmission and possible amplifier damage (not covered under warranty).

### 4.4. Tuning



Tuning is possible only in the OPERATE mode.

Press the **OPER** button in order to illuminate its LED (unless AUTO-OPERATE is active).

#### a) Preliminary information

Tuning the amplifier involves a procedure of matching the impedance of the currently used antenna and transmission line to the amplifier tube's optimum characteristic load resistance. This will ensure maximum plate efficiency and optimum RF gain at nominal output power, with minimal distortion and spurious output.

Note that REFLECTED POWER readings and the measured SWR depend on the antenna and transmission line impedance only, and not on amplifier tuning. If the load impedance is not a nominally resistive 50-Ohms, the REFLECTED POWER indicator will always show a reading, no matter what the tuning settings.

Proper tuning is always necessary, however, and will allow you to operate at a high power level, without distortion or any danger to the amplifier.

Note also that the real OUTPUT POWER presented to the load (the antenna and transmission line) is equal to the difference between the FORWARD and REFLECTED power readings. For instance, with a 2.4:1 SWR load, readings of 1500 W and 250 W FORWARD POWER and REFLECTED POWER respectively, the real OUTPUT POWER is 1250 W. At a very high SWR levels, such as when no antenna is connected or a badly mismatched antenna is used, the FORWARD and REFLECTED readings will be almost equal, while the real OUTPUT POWER (the difference between them) will be nearly zero.

The amplifier can operate safely if the following rule is obeyed:

**"REFLECTED POWER < 300 W".**

Also, impedance matching capability is assured for loads presenting a SWR of up to 3:1. Nevertheless, for some loads and bands, matching is possible at even higher SWR levels. The maximum usable forward power at a SWR of 3:1 is 1200 W with 300 W reflected. For higher than 300 W reflected power a **\*\*REFLECTED POWER\*\*** SOFT-FAULT protection trip will occur.

For example, this can happen at full-scale 1500 W forward and 375 W reflected power, into an antenna having a SWR of 3:1 or worse.

#### NOTICE

Using a feeder of coaxial cable at SWR > 3:1 on HF, and particularly on the 10- and 6 meters bands, is not recommended. At such high values of SWR, the high voltages, high currents, and heat associated with line losses, risk to permanently damage your coaxial cable or antenna switch.

It is highly advisable to re-adjust amplifier tuning when antennas have been changed.

Re-adjust amplifier tuning when you change the band or between CW and SSB segments within the same band.

Update tuning periodically, even if you have not changed band or antenna, in particular when a significant change in the environment occurs (snow, ice, newly appeared or removed massive objects, alien wires nearby etc.) that would cause significant changes in the antenna impedance and an increased SWR.



If you use more than one antenna per band, it is necessary that you select the proper antenna BEFORE the next step. Retune after selecting a different antenna for the same band, since both impedances may differ substantially (unless their SWRs are excellent, i.e., below 1.2:1 for both).

At SWR above 1.2, retuning is mandatory although the two SWRs might be nearly same, for example 1.8 and 1.7 for the old and a new antenna. It might happen that one antenna is 90 Ohms and the other - 30 Ohms, each requiring totally different tuning.

**NOTICE**

Do not switch the **ANTENNA** or **BAND** switch knob while tuning or transmitting with the amplifier! Hot switching will eventually destroy the **BAND** switch, not covered by the warranty!

**NOTICE**

When tuning, never apply continuous drive longer than 3 (three) minutes without pausing at least 1-2 minutes to allow the tube to cool.

It is recommended that for initial tuning a free frequency in the middle of the band be selected (make sure the frequency is not being used by others so that you do not make QRM).

First, with **no drive power applied**, select the band and correct antenna number. Then, use **Table 4-1 Approximate tuning presets** in order to achieve an approximate preset for both **TUNE** capacitor and **LOAD** capacitor knobs settings:

Band, MHz	Tune Knob Dial	Load Knob Dial
1.800 - 2.000	55 - 42	75 - 60
3.500 - 4.000	59 - 45	73 - 60
7.000 - 7.300	56 - 50	65 - 57
10.100 - 10.150	15 - 14	25 - 24
14.000 - 14.350	64 - 52	30 - 29
18.068 - 18.168	74 - 68	70 - 68
21.000 - 21.450	26 - 20	47 - 45
24.890 - 24.990	72 - 70	60 - 59
28.000 - 29.700	35 - 21	45 - 39
50.000 - 54.000	32 - 16	20 - 15

Table 4-1 Approximate tuning presets

- b) Selecting the plate-load True Resistance Indicator (TRI) tuning aid

You may select the TRI scale in three different ways:

- By pressing the **PREV+NEXT** buttons simultaneously for a moment. This will insert a 6 dB attenuator between the driver and the amplifier's input (the ATT LED will light), so you will not need to reduce the drive power during tuning. Press **PREV+NEXT** buttons momentarily again to switch the attenuator off the input and to return to the old screen. If you use any of **PREV** or **NEXT** buttons only, the attenuator would be switched off too, but the information screen would change to respectively previous or next;

- By pressing repeatedly either **PREV** or **NEXT** button (whichever is nearest), until you reach the TRI scale.  
This will not insert the attenuator, so you will have to use less than 20 W drive (unless the amplifier is nearly correctly tuned), otherwise the next step would be executed automatically;
- By simply applying a normal working (60-85 W) drive power, while the amplifier is not yet tuned.  
This will automatically invoke the TRI tuning aid and will insert the input attenuator (the ATT LED will light) after one second. The attenuator will be switched off, and the old screen will be returned automatically, after you release the PTT shortly.  
If you have achieved meanwhile a nearly good tuning, the attenuator would not be inserted again. If the old screen was the same (TRI, selected manually earlier), you will then be able to precisely tune the amplifier also at nominal power, without changing drive at all. Use this hint to shorten the tuning process duration.

### c) Tuning Procedure

While a continuous carrier (CW key down, RTTY or FM) signal at the desired frequency is still applied:

- Look at the upper scale (FORWARD POWER). Obtain maximum power using the upper **TUNE** knob;
- Look at the lower (Load Cap) scale and turn the lower **LOAD** knob in order to center the triangle marker at the "!" mark.
- Release the PTT shortly in order to disable the attenuator, then repeat both steps at nominal power. Always finish by peaking with the **TUNE** knob.



Appearance of an arrow on either left or right TRI scale edges means that the **LOAD** knob is too far from the proper position. To correct this, turn the **LOAD** knob to the prompted direction until the triangle marker appears inside the scale field.



No marker:  
Use TUNE knob for max. P to get any marker.

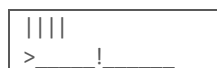

Marker is a far left:  
Turn LOAD knob pointer to right until marker inside.



Marker is a far right:  
Turn LOAD knob pointer to left until marker inside.

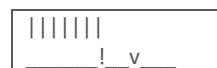

Marker inside:  
Turn LOAD knob slightly left to center it.



LOAD is tuned:  
Turn TUNE knob to peak Forward Power & finish.

Figure 4-1 Using TRI tuning aid

Please note also, that the TRI mark will not appear until at least 5 W drive is applied, and at least 20 W forward power is achieved.

If, for some reason, matching cannot be accomplished successfully, check **BAND** switch position and proper antenna selection. Then check the antenna SWR at the same drive frequency.

#### d) Tuning hints

While turning the knobs, you will note that both tunings would be virtually independent. This is a benefit of the TRI. The plate-load resistance increases to the right and decreases to the left of the TRI center.

The center of the scale corresponds to the proper **LOAD** capacitor tuning, which presents an optimum load resistance to the tube.

If you tune to the right, you will obtain more gain, but less undistorted output power will be attainable. You may prefer to use this hint when your drive power is insufficient or when you need less output but better efficiency, for instance at heavy duty modes (RTTY, SSTV, etc.) where less heat is wanted (not only in the amplifier but also in the transceiver).

Tuning to the left of the center would lead to the opposite: less gain and more power attainable. Of course, this requires more drive power, more plate current, and more plate heat, which shortens tube's-expected life, as its cathode would be faster exhausted.

Off-center tuning may also be used to compensate for line (mains) voltage variations in order to maintain tube efficiency. In that case, tune to the right when mains is higher, or tune to the left if it's lower than the nominal voltage. However, where there is more than a 5% difference from the nominal line (mains) voltage, the voltage selector inside the amplifier should be changed (see Section [2.2 Line Voltage Selection](#)).

### 4.5. Continuous Carrier Modes

The maximum output power in continuous carrier modes such as RTTY etc. is 1200 W. You may exceed this limit up to about 1300 W for short periods (one minute or less), while adjusting the drive power for instance. Please, have in mind, that the mean output power should not exceed 1200 W for longer periods.

For prolonged transmissions the amplifier gain can drop between 5% and 10% during the first minute which is normal while temperature balance of the tube is achieved. You can easily compensate this by increasing the drive power slightly. Once the drive power has been set, the output power remains stable with the time for hours.

#### **NOTICE**

For transmissions longer than 15 minutes the external auxiliary fan must be installed (see Section [2.5 Installation of External Fan](#)).

#### 4.6. ON LINE Information Screens and Control Functions

- a) Besides the Warming Up and TRI (described above in Sections [4.1 Turning ON and OFF](#) and [4.4 Tuning](#)), you have 12 more Information screens available. They are as follows:
- Forward Power
  - Reflected Power
  - Output Power (difference between Forward and Reflected)
  - Antenna VSWR
  - Drive RF Power
  - RF Power Gain
  - Plate Current
  - High Voltage
  - Plate RF Peak
  - Screen Current
  - DC Power Input (product of plate current and high voltage)
  - Exhaust Air Temperature (Celsius and Fahrenheit scales).

You can use them to monitor the technical state of the amplifier and associated parameters in digital form.

Selection is made by the **PREV** and **NEXT** buttons. You may change them in a closed loop, while the amplifier is used and controlled in OPERATE and STANDBY modes, changes transmit and receive, without any influence by the measurement process.

- b) You can control the display brightness (not operative in unit furnished with OLED display), AUTO-OPERATE feature, and antenna output assignments while ON LINE. In order to enter the control menu, press the **PREV+NEXT** buttons simultaneously and hold them for two seconds. Further proceed as described for OFF LINE mode below - see Sections [5.1 Display Brightness Control](#), [5.2 Auto-Operate Enabling and Disabling](#) and [5.3 Antenna Output Assignment](#) for details.

#### 4.7. Auto-Protection System

When any abnormal amplifier condition is detected, the risk will be evaluated automatically and three different degrees of protection may be used depending on the nature of the problem. Each event is accompanied by a text telling you the reason.

Degrees of protection:

- a) **First degree of protection - WARNING**

The First Degree of protection is issuing a **WARNING** message only, without any influence on the transmitting process. This might be for instance "Reduce Drive", "Plate Current", etc. You could continue to transmit under such conditions but you are close to a trip threshold.

**b) Second degree of protection - SOFT FAULT**

The Second Degree of protection is a trip in STANDBY mode (SOFT FAULT). You will get an appropriate message, for instance **\*\*GRID CURRENT\*\***. All SOFT FAULT messages are marked with two asterisks on both screen edges. The message remains on the display until you press any button (or AUTO-OPERATE function returns to OPERATE mode automatically). The SOFT FAULTs are of such kind where you can correct exploitation conditions operatively (using less drive, reducing antenna SWR, etc.).

**c) Third degree of protection - AUTO PROTECTION**

The Third Degree of protection is a trip to OFF LINE mode (AUTO PROTECTION). You will get the corresponding signature (see Section **6.6 Troubleshooting**). If you cannot guess what is the reason, you may try to turn the amplifier on again in order to check whether it's not an accidental condition. If the problem persists, you will need to contact your dealer (see Section **1.2 Owner Assistance**).



The 6 dB input attenuator is automatically inserted about 1 (one) second after a bad tuning is detected at drive levels above 20 W. It is switched off at every PTT release (unless inserted manually).

## 5. OFF LINE MODE

There are two control functions and 14 information screens available in this state of the amplifier. You can enable/disable the AUTO-OPERATE feature, and assign the antenna outputs. You can also list the auto-protection signatures.

The tube is not powered at all (only the micro-controller is active) during these operations.



All menu selections you make are stored in the nonvolatile memory of the amplifier and are used at the next power-on. If no menu selection is made for 20 seconds, the current selection is accepted and the function is left automatically.

### 5.1. Display Brightness Control



The Brightness can be adjusted only if the display is VFD (Vacuum Fluorescent Display) type (obsolete since 2015).  
Not operative in units furnished with OLED display.

Press the **PREV+NEXT** buttons simultaneously and the "Brightness=..." screen will appear on the bottom line. Use the **NEXT** button to control the display brightness in steps from 1 to 4.

Briefly press the **PREV+NEXT** buttons in order to reach the Auto-operate function (see Section [5.2 Auto-Operate Enabling and Disabling](#)), or leave the buttons unused for 20 seconds if you want to accept these selections.

### 5.2. Auto-Operate Enabling and Disabling

When enabled, this function will keep the amplifier in OPERATE mode automatically. The **OPER** button will be still functional, so you will be able to change to STANDBY and back to OPERATE manually at any time. The AUTO-OPERATE function will be disabled temporarily when you enter the STANDBY mode but it will be restored after you return to OPERATE by depressing the **OPER** button. See Section [4.2 Changing OPERATE and STANDBY Modes](#).

Press the **PREV+NEXT** buttons in order to enable or disable the AUTO-OPERATE feature. The "Auto Operate = ..." screen will appear on the bottom line. Use the **PREV** button to select OFF or the **NEXT** button to select ON.

Briefly press the **PREV+NEXT** buttons again in order to reach the last control function - the Antenna Outputs Assignment (see Section [5.3 Antenna Output Assignment](#)). Alternatively, you may leave the buttons unused for 20 seconds. In any case, the selections made so far will be retained in the amplifier's memory.



### 5.3. Antenna Output Assignment

#### NOTICE

If there is no antenna connected to an antenna output then the output should be disabled. This will make the switching between two available antennas easier and, more important, it will prevent potentially damaging no-load transmissions.

In order to enable or disable an antenna output, briefly press **PREV+NEXT** buttons successively until the "Ant: (1-...) 2-... 3-..." screen appears. Using the **ANT** button, move the brackets to enclose the antenna output you want to disable or enable. Press the **PREV** button to disable or **NEXT** to enable it.

Press **PREV+NEXT** briefly again to confirm the antenna output assignments and then leave the menu.

### 5.4. Reading Auto-protection Signatures

On every HARD FAULT protection trip of the amplifier, signature information is stored in its nonvolatile memory. The 7 most recent auto-protection trip signatures related to the amplifier internal status are stored there, which you can copy and forward to your dealer for diagnostics.

In order to read the trip signatures, press the **OPER** button while OFF LINE. The beginning of the signatures list will appear. Use **NEXT** and **PREV** buttons to navigate through the 7 pairs of screens. For each auto-protection trip there is a pair of information lines beginning with nA... and nB... where:

- "n" is the successive number of the event (Nr. 1 is the latest, Nr. 7 is the oldest one);
- "A" and "B" mark the first and second parts of an information screen pair.

Two lines, three groups by six symbols (36 symbols in total) are to be copied concerning every one of the 7 memorized events, from 1A-1B through 7A-7B.

To decode the signatures, please, see Section [6.6 Troubleshooting](#).



After every signature listing the tube warm-up time is reset to 180 seconds regardless of the time being in OFF LINE state.

## 6. MAINTENANCE

### DANGER

Both the mains voltage and the high voltages up to 3000 V inside the amplifier are LETHAL!

For your safety, pull the amplifier power plug out of the mains wall outlet and WAIT AT LEAST 30 minutes EACH TIME BEFORE you remove the cover of the amplifier. Do not touch any part inside while the amplifier is open because some residual voltages may still be present.



If no indicator glows upon switching the amplifier ON, the main fuse(s) may have blown (see Section [6.3 Fuse Replacement](#)).



If the characters on the VFD are dim, please, see Section [5.1 Display Brightness Control](#) (not operative with OLED display).

### 6.1. Periodic Maintenance

#### a) Periodic checks

Periodically (but at least once per year) check all connections, contact cleanliness and the tightening of all connectors, in particular the coaxial ones.

Check the integrity of the cables, in particular when they are laid on the floor. Check also if the cables are secured well in the area where they come out of the connector body.

Pay particular attention to the mains plug and the wall outlet (see Sections [2.4.g\) Power cord](#) and [2.4.h\) Preparation of wall outlet](#)). If you have any doubts consult with a qualified electrician.

Periodically check the SWR of the antennas and if this changes over time. Problems could occur more often in poor weather conditions - rain, snow, strong wind etc.

#### b) Air filter

Periodically (more often in a dusty environment, but at least once per year) clean the air filter without opening the amplifier (see [Figure 2-1 Rear panel - Connections](#), Pos. (1)).

### CAUTION

The air filter may be too dusty - be careful how you clean it so that you DO NOT INHALE (BREATHE IN) neither spill the dust over! Wrap it, for instance, in a wet cloth before cleaning!

## 6.2. Cleaning

### ⚠ CAUTION

Do not use any solvents for cleaning. They may be dangerous to you and damage amplifier surfaces, paint and plastic components.

Do not open the amplifier. Cleaning of the amplifier outer surface can be done with a piece of soft cotton cloth lightly moistened with clean water.

Also, clean (as much as possible from the outside, without opening the amplifier) all ventilation apertures on the cover and the chassis, including the ones on the bottom.

### ⚠ DANGER

Never push or put anything into holes in the case - this will cause electric shock.

## 6.3. Fuse Replacement

### ⚠ DANGER

If replacement of fuses is necessary, first pull out the amplifier mains plug from the mains outlet and wait for at least 30 minutes!

### NOTICE

For replacement, only use standard fuses from the types recommended below.

The two Primary Mains Fuses of the amplifier are located on the rear panel (see [Figure 2-1 Rear panel - Connections](#), Pos. (f)). They are fuses of the "F" type (fast-acting / quick-acting / fast blow / quick blow), size 1/4x1-1/4 inch (6.3 x 32 mm), ceramic or glass body cartridge.

The fuses must be rated for a current corresponding to your mains nominal voltage:

- 16 A / 250 V for operation from 200-240 VAC (15 A standard is also acceptable);
- 20 A / 250 V for operation from 100-120 VAC.

Suitable fuses are:

- For 200-240 VAC mains nominal voltage, e.g.:
  - EATON Bussmann, PN: BK/ABC-15-R (ceramic body cartridge);
  - SIBA, PN: 70-059-60/16A (glass body cartridge).
- For 100-120 VAC mains nominal voltage, e.g.:
  - EATON Bussmann, PN: BK/ABC-20-R (ceramic body cartridge);
  - SIBA, PN: 70-059-60/20A (glass body cartridge).



If, after Primary Mains Fuses replacement, the device does not operate normally, we recommend repair, performed only by a trained service technician.

Contact your ACOM dealer for assistance (see Section [1.2 Owner Assistance](#)).

Besides the primary fuses, on the MAINS PCB (inside the amplifier) there are three fuses which **are not replaced by the user**. They are fuses of the "T" type (time-lag / slow-blow), European size 5x20 mm, ceramic (or glass) body cartridge, as follow:

- 1 x 0.2 A, 250 V;
- 2 x 2 A, 250 V.

Suitable fuses are:

- 0.2 A, 250 V, e.g.:
  - Littelfuse, PN: 0215-200 (ceramic body cartridge);
  - Littelfuse, PN: 0218.200 (glass body cartridge);
- 2 A, 250V, e.g.:
  - EATON Bussmann, PN: S505-2-R (ceramic body cartridge);
  - Littelfuse, PN: 0218002 (glass body cartridge).

### WARNING

Do not replace fuses located inside the amplifier.

Blown internal fuses can be a symptom of a more serious problem, which should be resolved beforehand. A fault of this type will not occur under normal operating circumstances.

Replacing internal fuses is a complex and potentially dangerous operation.

For this reason, we recommend this work be carried out only by a trained service technician.

Contact your ACOM dealer for assistance (see Section [1.2 Owner Assistance](#)).



Unauthorized replacement of inside fuses infringes the warranty conditions!



Besides specific national standards, the principal fuses standard applied worldwide is IEC 60127.

## 6.4. Tube Replacement

A single 4CX1000A/8168 ceramic and metal tetrode is employed in the amplifier.

### DANGER

Tube replacement is a complex and potentially dangerous operation that involves adjustment of the plate idling current and is Life-threatening!

For this reason, we recommend this work be carried out only by a trained service technician.

Contact your ACOM dealer for assistance (see Section [1.2 Owner Assistance](#)).

## 6.5. Simplified Schematic Diagram

Please, see *Figure 6-1 Simplified schematic diagram*.

The 4CX1000A/8168 ceramic and metal radial beam tetrode (V1) is grid-driven. It can dissipate up to 1000 W when forced air cooled and is specifically designed for class AB1 RF linear amplifiers.

The input signal from the **RF INPUT** jack is passed through a broadband input matching circuit, which consists of components in the INPUT PCB and Rsw. This circuit tunes out the tube input capacitance. The swamping resistor Rsw is a termination load for this circuit and can dissipate up to 100 W of RF drive power.

Cathode resistors labeled Rc create DC and RF negative feedback, thus stabilizing the gain and equalizing the frequency response. The varistor VSsg, in the screen grid circuit protects the tube and the screen grid voltage regulator in the event of an internal tube flashover.

The combination noted as Lp1-Rp1 in the plate circuit is a VHF/UHF parasitic suppressor. DC plate voltage is fed through chokes RFC1-RFC2 and the capacitor Cb3 blocks it from the output. The output circuit consists of LP1, LP2, LL, CP1-CP3, and CL1-CL3, which form a classic Pi-L network to suppress any harmonic frequency emissions. This tank is switched and tuned by S1A-S1C and the air variable capacitors CP1, 2 and CL1, 2. The output signal is fed through an additional VHF low-pass filter for frequencies above 55 MHz (Lf1, Lf2 and Cf). Then it is passed through the vacuum antenna relay K1, wattmeter current transformer TA1, and a high-pass filter RFCasw-Casw for frequencies below 100 kHz, to the antenna switch and the three outputs. The chokes RFC3 and RFCasw keep track of the antenna relay contacts and together with Casw prevent the plate supply voltage from reaching the antenna. The RF choke RFCasw shunts the high voltage to ground should the DC blocking capacitor Cb3 fail. The resistor Rasw protects Casw from electro-static voltage build-up from the antenna.

The PLATE CAPACITIVE DIVIDER and RF WATTMETER are the main sources of information for the control circuit of the amplifier during the antenna impedance matching process.

All supply voltages are delivered from the MAINS&LOW VOLTAGE and HIGH VOLTAGE SUPPLY PCBs. The control grid, screen grid, and plate currents, plate cooling airflow temperature, reflected power, etc. are continuously monitored by the Control PCB. Many software-derived protections are based on this information.



Detailed electrical schematic diagrams are available from ACOM or from your dealer on request.

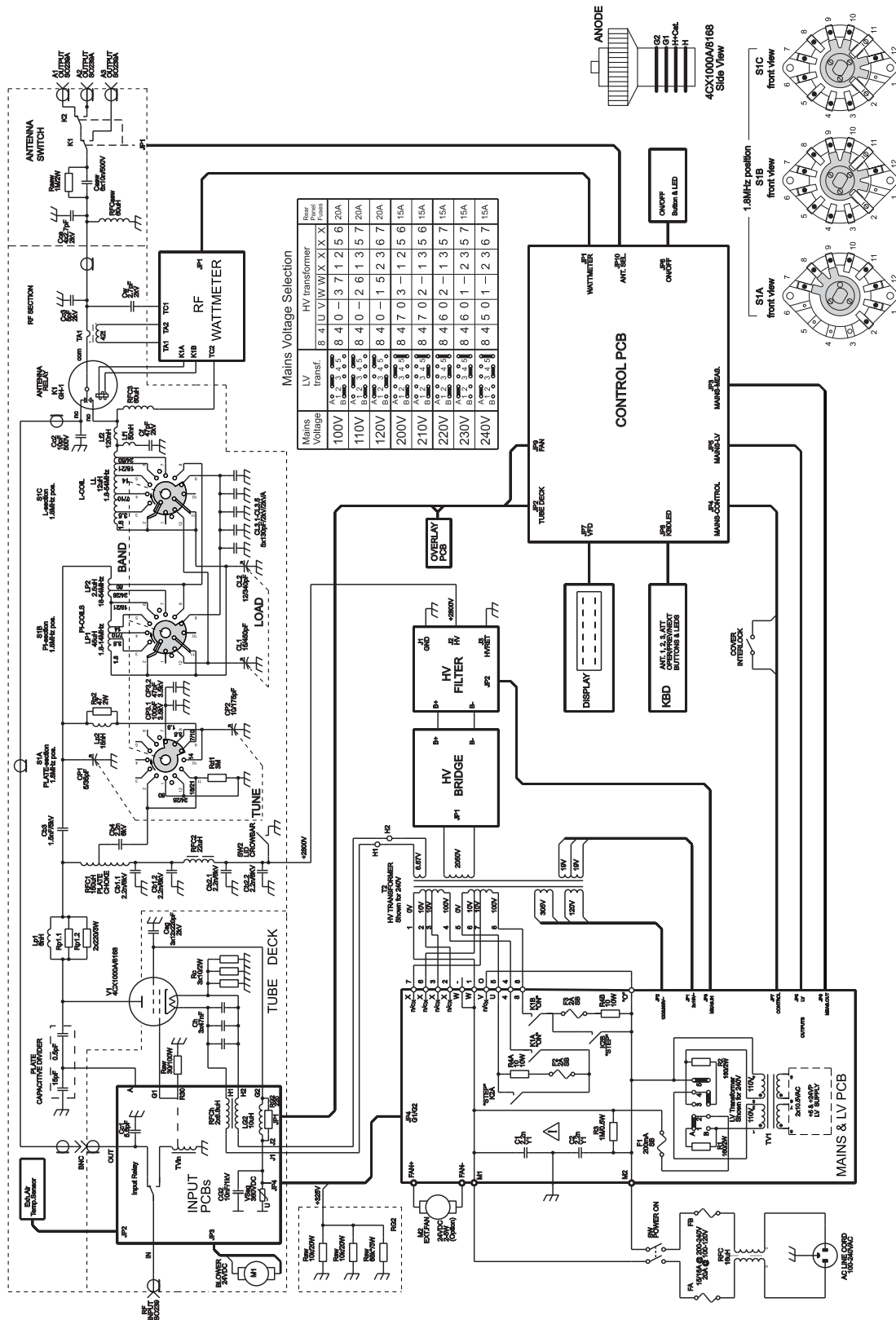

Figure 6-1 Simplified schematic diagram

## 6.6. Troubleshooting

Please, see Section **5.4 Reading Auto-protection Signatures** for the method of reading the auto-protection signatures. You can decode them using the information below.

The signatures are structured in two lines, three groups by six symbols for every one event of auto protection. The latest event is numbered as 1A-1B pair of lines, and the oldest one is 7A-7B.

The meaning of the first group is as follows:

- a) nA     The number of the trip;
- b) Next three symbols mean the following:
  - PN0     Tests made during POWER-ON procedure, before HV is ON;
  - PN2     Tests made during POWER-ON procedure, after HV is ON and one second after step-start relay is closed;
  - SB0     Tests made in STANDBY mode, during the warm-up period or while entering STANDBY mode (from OPERATE mode);
  - SB2     Tests made during STANBY mode, after the warm-up period;
  - PR0     Tests made while entering OPERATE mode;
  - PR2     Tests made during OPERATE mode;
  - TR0     Antenna relay tests made while changing from Tx to Rx (during OPERATE mode);
  - TR2     Antenna relay tests made while changing from Rx to Tx (during OPERATE mode);
  - TR4     Antenna relay tests made during Tx (OPERATE mode);
  - TR6     Antenna relay tests made during Rx (OPERATE mode).
- c) The last symbol of the first group designates the kind of the input parameter that caused the protection circuit to trip. The abbreviations in brackets below are the signal names/designations according to the CONTROL PCB electrical schematic diagram and signal type (see the **I-info** note below):
  - 1        Peak forward power (pfwd, analogue);
  - 2        Reflected power (rfl, analogue);
  - 3        Input (drive) power (inp, analogue);
  - 4        Peak anode alternate voltage (paav, analogue);
  - 5        Screen grid current (g2c, analogue);
  - 6        Plate current (ipm, analogue);
  - 7        High voltage (hvm, analogue);
  - 8        Exhaust air temperature (temp, analogue);
  - 9        Drive power present on control grid (\*GRIDRF, logic);
  - A        RF power present in the antenna (\*PANT, logic);



- B Output relay closed (ORC, logic);
- C RF arc fault (ARCF, logic);
- D Control grid current too high (G1C, logic);
- E +24 VDC power supply error (PSE, logic);
- F Low airflow (LAIR, logic).

For instance, "1ATR4B" in the first group would mean that the latest auto-protection (1A) tripped by the antenna relay tests made during the Tx - OPERATE mode (TR4), and the "Output relay closed - ORC" signal was failing (B).

The next five groups of symbols carry information about the analogue and logic values as measured by the micro-controller at the moment of auto-protection trip.



Detailed electrical schematic diagrams are available from ACOM or from your dealer on request.



Additional information is available from ACOM or from your dealer on how to interpret these values. Using an Excel application available from ACOM or your dealer free of charge, and a PC, you can decode these signatures.

In case it is necessary to ship the amplifier, please, see Section **7.3 Storage and Shipment**.

## 7. SPECIFICATIONS

### 7.1. Parameters

- a) Frequency Coverage
  - All amateur bands in the 1.8-54 MHz frequency range;
  - Extensions and/or changes on request;
- b) Power Output
  - 1500 W PEP or 1200 W continuous carrier, no mode limit;

#### **NOTICE**

You will have to reduce the output power to about 1000 W PEP in order to keep the mains current consumption below 20 A if the amplifier is operated at 120 VAC or lower mains supply voltage.

#### **NOTICE**

In continuous carrier modes (RTTY etc.) for transmissions longer than 15 minutes (up to several hours depending on ambient temperature), the external auxiliary fan must be mounted.

- c) Intermodulation Distortion
  - Better than 35 dB below PEP rated output;
- d) Hum and noise
  - Better than 40 dB below rated output;
- e) Harmonic Output Suppression
  - 1.8-21.5 MHz - better than 50 dB below rated output;
  - 24-54 MHz - better than 66 dB below rated output;
- f) Input and Output Impedances
  - Nominal value: 50 Ohm unbalanced, UHF (SO-239A) type connectors;
  - Input circuit: broadband, SWR less than 1.3:1, 1.8-54 MHz continuously (no tunings, no switching);
  - Bypass path SWR less than 1.1:1, 1.8-54 MHz continuously;
  - Output (antenna) impedance matching capability: SWR up to 3:1 or higher;

- g) RF Gain
  - 13 dB typically, frequency response less than 1 dB (60-85 W drive power for rated output);
- h) Mains Power Supply Voltage
  - 85-132 VAC / 170-264 VAC (100, 110, 120, 200, 210, 220, 230 & 240 V nominal taps, +10% -15% tolerance), 50-60 Hz, Single phase;
- i) Mains Power Consumption
  - Up to 3500 VA at rated output from 200/240 VAC mains supply;
  - Up to 2400 VA at 1000W output from 100/120 VAC mains supply;
- j) Safety and Electromagnetic Compatibility
  - Complies with CE safety and electromagnetic compatibility requirements, as well as with the US Federal Communications Commission (FCC) regulations;
- k) Size & Weight (operating, excluding connected cables)
  - WxDxH: 422x355x195 mm, 26.5 kg (16.7x14.0x7.7 inches, 58.5 lbs.);
- l) Operating environments
  - Temperature range: 0 to +50 degrees Celsius (32 °F to 122 °F);
  - Relative air humidity: up to 95% @ +35 degrees Celsius (95 °F);
  - Height above sea level: up to 3050 m (10000 ft) without output deterioration.

## 7.2. Functions

- a) Antenna Impedance Matching Process
  - Plate-load True Resistance Indicator (TRI) aided;
- b) Antenna Outputs
  - Three antenna outputs selectable by a button on the front panel;
- c) T/R System
  - QSK operation with quiet, built-in vacuum RF antenna relay;
- d) Protections
  - Cover interlock for operator's safety;
  - Inrush power-on current is limited;
  - High voltage, control grid, screen grid, and plate currents;
  - Exhaust air temperature;
  - T/R sequencing;
  - Antenna relay contacts, including RF power induced in antenna from another nearby transmitter;
  - Antenna matching quality;
  - Reflected power;
  - RF arcs, including in antenna system;
  - Overdrive;
- e) Signatures of the amplifier internal status are stored in a nonvolatile memory for the 7 most recent auto protection trips;
- f) OLED display with bar graph for forward peak power and text messages to the operator;
- g) Measurement and constant monitoring of 12 most important parameters of the amplifier via OLED;
- h) Tube
  - A single 4CX1000A/8168 ceramic and metal radial beam tetrode with plate dissipation of 1000 W (forced air cooled, grid-driven), specifically designed for class AB1 RF linear amplifiers.

### 7.3. Storage and Shipment

#### 7.3.1. Storage Environment

The amplifier may be kept packed in a dry, ventilated and unheated location (with no chemically active substances such as acids or alkalis) within the following environment ranges:

- Temperature range: -40 to +70 degrees Celsius (-40 °F to 158 °F);
- Humidity: up to 75% @ +35 degrees Celsius (95 °F).

#### 7.3.2. Shipping Size and Weight

- WxDxH: Approx. 590x490x380 mm, 30.0 kg (23.3x19.3x15.0 inches, 66.2 lbs.);

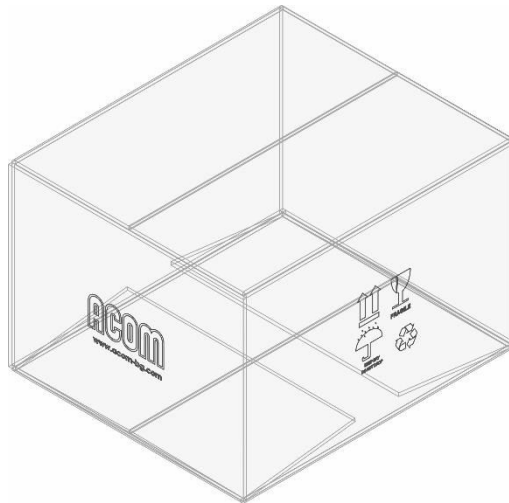

Figure 7-1 Packaging cardboard box

#### 7.3.3. Transportation

All types of transportation may be used, including storage in an aircraft baggage compartment at up to 12000 meters (40000 ft) above sea level.

#### 7.3.4. Returning to the Service Provider

**NOTICE**

Should it be necessary to ship the amplifier, use the original packing as described below.

Switch off the amplifier, pull the line (mains) plug out of the outlet, disconnect all cables from the rear panel of the amplifier (remove the ground connection the last), and then pack the amplifier in its original carton.

**7.4. Information on Disposing and Recycling of Old Electrical and Electronic Equipment**



The information in this section is applicable for countries that have adopted separate waste collection systems.

ACOM products cannot be disposed as household waste.

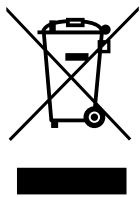

Waste electricals

This symbol (crossed-out wheeled bin) explains that you should not place the electrical item in the general waste.



Waste electricals

This symbol (three green arrows going in a triangle with electrical plug in the center) means that according to local laws and regulations this product should be sent for recycling.

Old electrical and electronic equipment and batteries should be recycled at a facility capable of handling these items and their waste byproducts.

Contact your local authority for details in locating a recycle facility nearest to you.

Proper recycling and waste disposal will help conserve resources whilst preventing detrimental effects on our health and the environment.



## NOTES

A series of horizontal dotted lines for taking notes.









This manual is for electronic distribution mainly.  
If you have it on paper and you no longer need it, please, recycle it!

The latest versions of our User's Manuals are available at  
[www.acom-bg.com](http://www.acom-bg.com)

Dealer/Partner's address:

# ACOM



📍 ACOM Ltd.

Bulgaria | Bozhurishte 2227  
Sofia-Bozhurishte Economic Zone | 6 Valeri Petrov Str.  
GPS coordinates: 42.748616° | 23.209801°

📧 [support@acom-bg.com](mailto:support@acom-bg.com)



[www.acom-bg.com](http://www.acom-bg.com)

ACOM and the ACOM logo are registered trademarks of ACOM Ltd. in many countries, including the EU and United States. | The used images are illustrative only. Subject to change without notice. | Printed in Bulgaria. All rights reserved. | Design and content by ACOM Ltd.

ACOM 1500 User's Manual | Fourth Edition, Revision 02 | August 2021.