

Operating and Installation Manual

Barrett 4075 Linear Amplifier

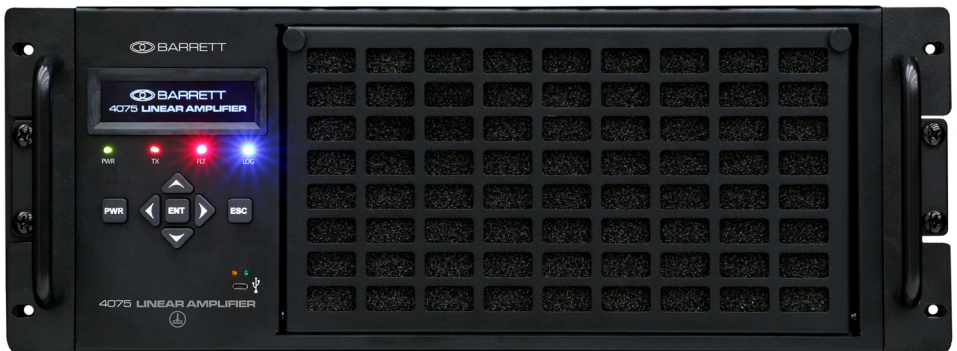

BCM407500/10

© Barrett Communications

Head Office:

Barrett Communications Pty Ltd
47 Discovery Drive, Bibra Lake, WA 6163 Australia
Tel: +61 8 9434 1700 Fax: +61 8 9418 6757
Email: information@barrettcommunications.com.au

www.barrettcommunications.com.au

Contents

Introduction	4
Terms and Abbreviations.....	4
Exploring the 4075 Linear Amplifier	5
Front Panel.....	5
Keypad	6
Rear Panel	6
Switching the Linear Amplifier On / Off.....	8
Switching the Linear Amplifier On.....	8
Switching the Linear Amplifier Off	8
Error States	9
Display	10
Main Menu	10
Configuration Menu.....	10
1 - Exciter	11
2 - ATU	11
3 - AUX.....	11
4 - Optical	11
5 - Network	11
6 - Language	12
7 - Other	12
8 - Factory Reset.....	13
Diagnostics Menu	14
1 - Clear Critical Error	16
2 - Filter Control Menu	16
3 - Attenuation Control	17
4 - Power Relay Control	18
5 - Power Supply Control	18
6 - Pallet 0 Control	19
7 - Pallet 1 Control	20
8 - Fan Control Menu	21
9 - Pump Control.....	22
10 - Bypass Lock On Control.....	22

Installation and Setup	23
Safety	23
Getting Started	23
Mains Connection	23
Ground (Earth) System	25
Land System Grounding	25
Marine System Grounding	26
Corrosion	26
Antenna Connection	27
Fitting the Linear Amplifier	27
4050 Transceiver Setup	27
4075 System Connections	28
4075 Connections - Rear View	29
System Description	31
In Standby (Receive) Mode (No PTT)	31
In Transmit Mode (PTT Active)	31
Operation Settings	32
Factory Settings	32
System Settings	32
Maintenance	33
4075 - Specifications	34
General	34
Mechanical	35
Environmental	35
Controls and Indicators	35
Connectors (Front)	36
Connectors (Rear)	36
Protection	36
Limited 3 Year Warranty Statement	37
Warranty Registration and Technical Support	38
Warranty Registration Contact Details	39

Introduction

The Barrett 4075 is a solid-state linear amplifier operating from 1.6 MHz to 30 MHz. It can be supplied with a power output level of either 500 watts or 1000 watts.

Extensive self-test, system monitoring, and protection circuits are provided, with status and tuning information being displayed on a large OLED display.

The exciter for the 4075 linear amplifier is a Barrett 4050 Transceiver set to "4075 Linear Amplifier" as the antenna type, where its power output is reduced to a maximum of 30 W, and 40 W above 20 MHz. The ALC voltage for the exciter is derived at the Linear Amplifier's output, and is passed to the exciter via the Breakout Box.

The Barrett 4075 Power Supply Unit provides the +48 volts required to power the amplifier.

Terms and Abbreviations

Term / Abbreviation	Definition
BoB	Breakout Box
CW	Continuous Wave (used for Morse code)
dB	Decibels
dBc	Decibels relative to the carrier - is the power ratio of a signal to a carrier signal, expressed in decibels.
dBm	Power ratio in decibels (dB) of the measured power referenced to one milliwatt (mW).
LPF	Low Pass Filter
OLED	Organic Light Emitting Diode
PEP	Peak Envelope Power
PTT	Press-To-Talk button
Selcall	Selective Calls
SSB	Single Sideband (a transmission format)
USB	Universal Serial Bus
VSWR	Voltage Standing Wave Ration

Exploring the 4075 Linear Amplifier



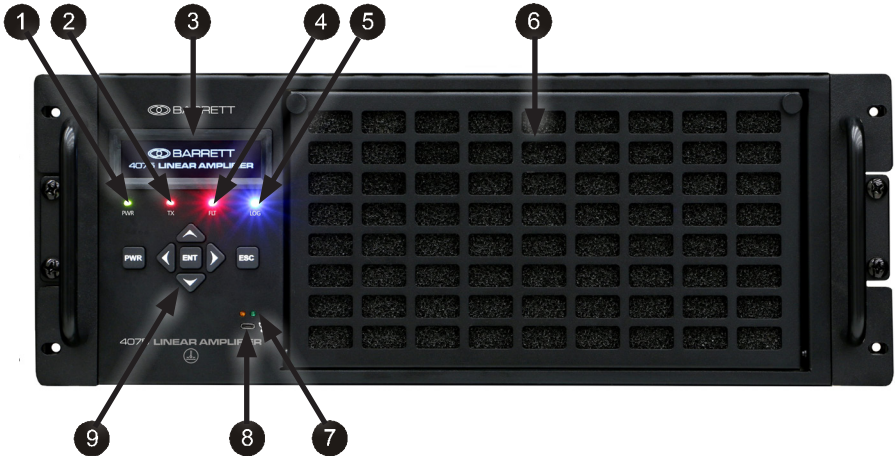

Front Panel





- 1 PWR LED illuminates green when the unit is powered on.
- 2 TX LED illuminates amber when the unit is transmitting (PTT on)
- 3 OLED screen
- 4 FLT LED illuminates red when the unit identifies a fault
- 5 LOG LED illuminates blue when logging the fault history
- 6 Grill and filter for the fans
- 7 LEDs to indicate transmit (amber) and receive (green)
- 8 USB socket for programming and diagnostics
- 9 Keypad

Keypad

There are seven keys on the keypad. Some keys have multiple functions assigned to them depending on when the key is pressed and for how long the key is pressed. Key functions are listed below followed by a description of their functions.

Key	Function
	Channel Up / Scroll up
	Channel Down / Scroll down
	Scroll left
	Scroll right

Key	Function
	Enter / Set a menu item
	On / Off button
	Escape / Back one step

Rear Panel

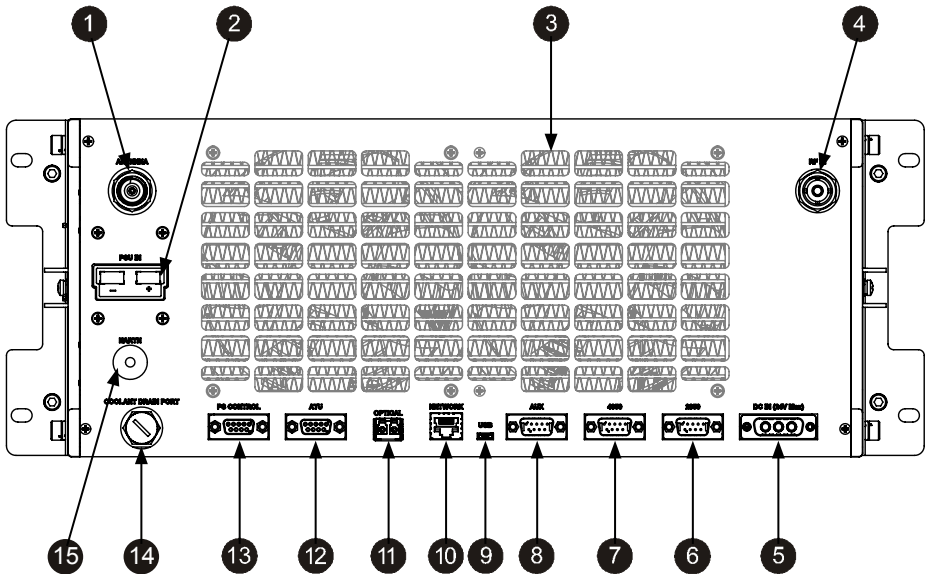

BARRETT 4075 LINEAR AMPLIFIER - OPERATING & INSTALLATION MANUAL

- 1 RF Out
- 2 48 V for Amplifier
- 3 Cooling fan /grill
- 4 RF In
- 5 12 V Power Supply from 4022
- 6 2050 interface
- 7 4050 Breakout Box Interface
- 8 Auxiliary input. Used if other equipment is far away. Alarms etc
- 9 USB Interface. Used for programming and diagnostics
- 10 Ethernet network interface
- 11 Optic Fibre
- 12 ATU Interface
- 13 Control connector for Power Supply
- 14 Drain Plug
- 15 Earth connection

Switching the Linear Amplifier On / Off

Switching the Linear Amplifier On



Press  to switch the unit on.

The Barrett splash screen displays.

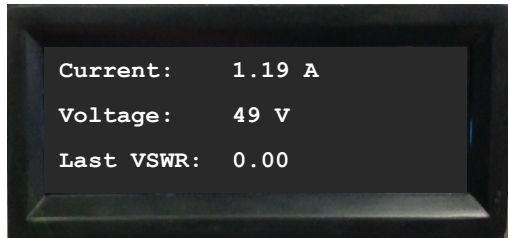

After two seconds the default screen displays showing various values.



Use the scroll keys  and  to display more values.

Press  to display the Main Menu.

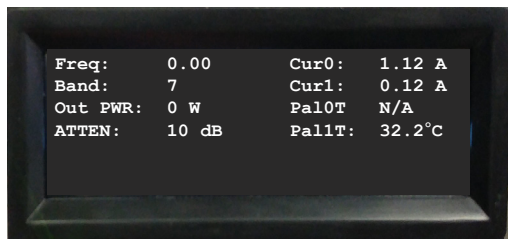

Switching the Linear Amplifier Off

Momentarily press  for five seconds to switch the unit off.

Error States

There are three types of error states that may be encountered during operation. These are:

Warning

The following message displays accompanied by an audible alarm and a flashing red LED.

This flashing message will continue until the fault condition clears. No user intervention is required.

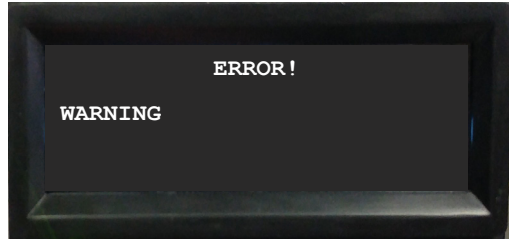

Error

The following message displays accompanied by an audible alarm and a flashing red LED.

This flashing message will continue until the fault condition clears or a key is pressed on the keypad. The LED will continue to flash but the navigational keys will now be operable.

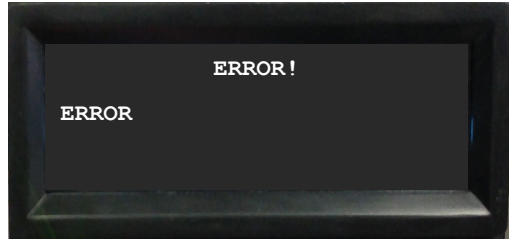

Critical Error

The following message displays accompanied by an audible alarm and a flashing red LED.

The critical error will cause the Linear Amplifier to shut down.

However, the message and LED will continue to flash until the Escape key is pressed.

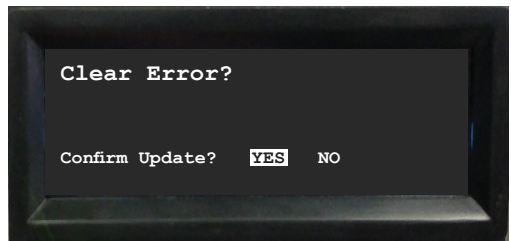
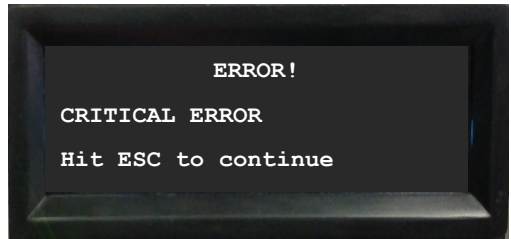

If the critical error is cleared, select **Yes** to continue.

See page 16 for further information.



Display



Main Menu

From the Main Menu, Press either  or  to move the selection up or down.

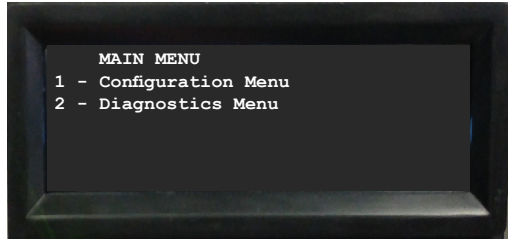
Press  to select either the Configuration Menu or Diagnostics Menu.



Configuration Menu

From the Configuration Menu, press either  or  to move the selection up or down.

Press  to select the required menu.

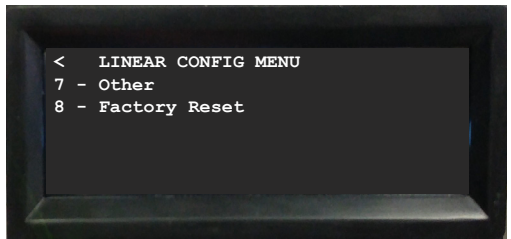
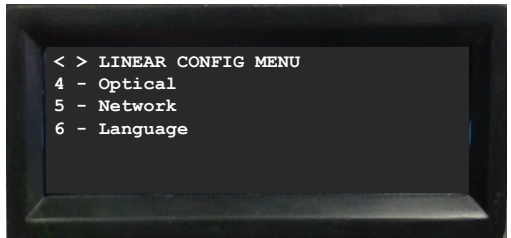
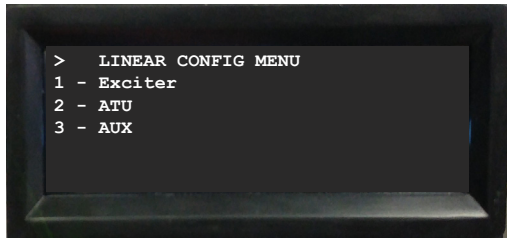



1 - Exciter

Use this option to select which exciter to use with the 4075 Linear Amplifier.

Alternative custom exciters (programmable) can be used.

Select Exciter from the Configuration Menu to display the following.

Press  or  to move the selection up or down.

Press  to set the selection.

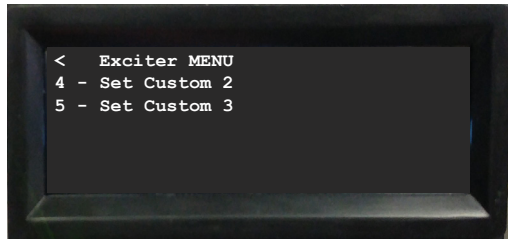
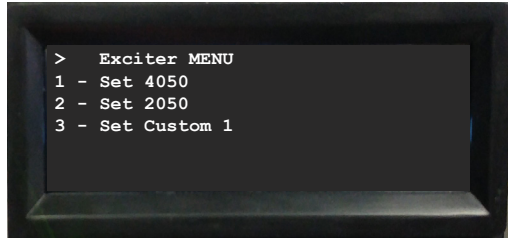

2 - ATU

N/A. Press  to return to the previous menu.

3 - AUX

N/A. Press  to return to the previous menu.

4 - Optical

N/A. Press  to return to the previous menu.

5 - Network



N/A. Press  to return to the previous menu.

6 - Language

N/A. Press  to return to the previous menu.

7 - Other

Select Other from the Configuration Menu to display the following.

Press  or  to move the selection up or down.

Press  to display the selected menu.

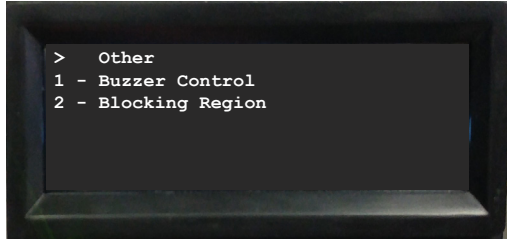

Buzzer Control



This option enables or disables the audio alarms.

Select Buzzer Control from the Other Menu to display the following.

Press  and  to toggle the selection on or off.

Press  to display the Confirmation screen.

A confirmation screen displays.

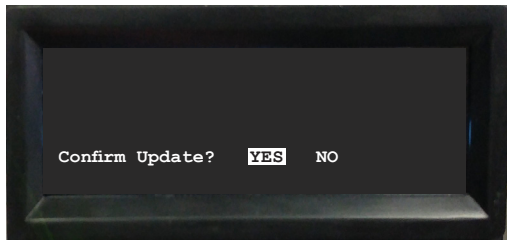
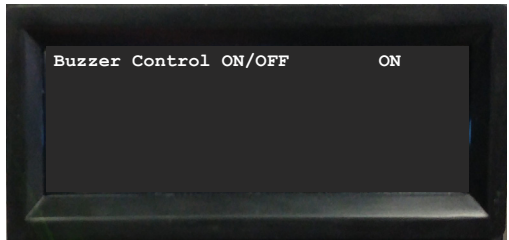

Press  or  to toggle the selection Yes or No to confirm and return to the Other Screen.



Blocking Region

Use this option to block programmable regions. Alternatively, select none.

Select Blocking Region from the Other Menu to display the following.

Press  or  to move the selection up or down.

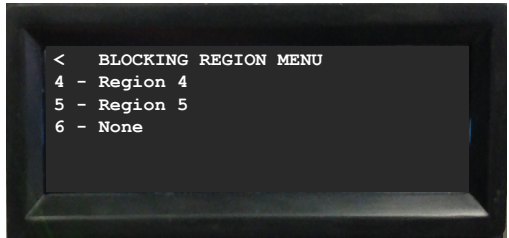
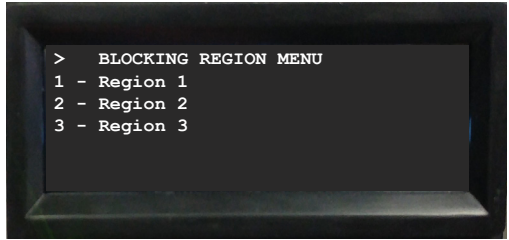

Press  to set the selection.



8 - Factory Reset

Use this option to revert all the values to the default.

Select Factory Reset from the Configuration Menu to display the confirmation screen.

Press  or  to toggle the selection Yes or No.

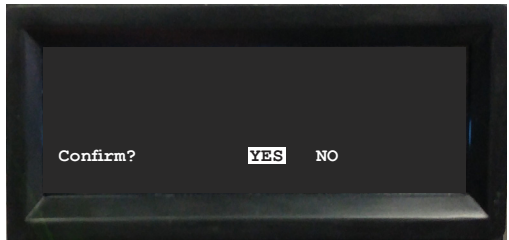

Press  to confirm and re-boot the Linear Amplifier.



Diagnosics Menu

A passcode is required to enter the Diagnostic menu.

Select the Diagnostics menu from the Main Menu to display the Passcode screen.

The passcode consists of four digits. The underscore represents the selected digit. To increment or decrement the value of the selected digit, press  or  respectively. To move to a different selected digit,

press either  or  to move left or right respectively.

Press  to enter the passcode.



If the entered passcode is incorrect, the following message displays.

Press  to return to the Passcode screen.

If the entered passcode is correct, the following message displays momentarily for two seconds.

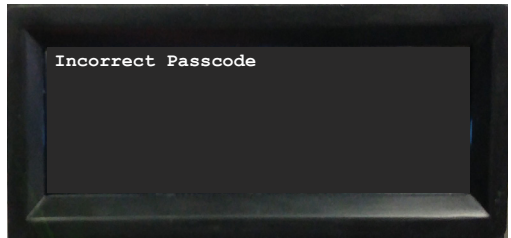
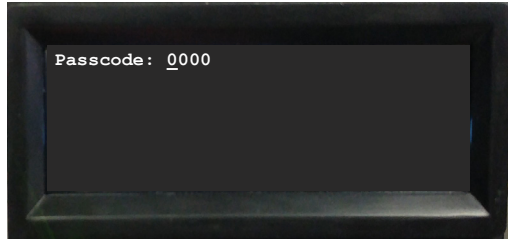
Press  to display the Diagnostic menu.



From the Diagnostics Menu, press either  or  to move the selection up or down.

Press  to select the required menu.

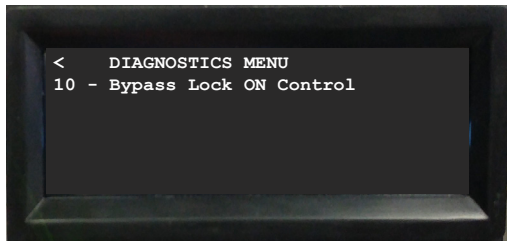
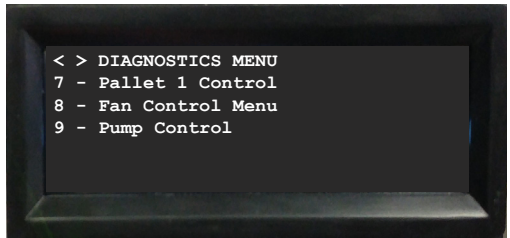
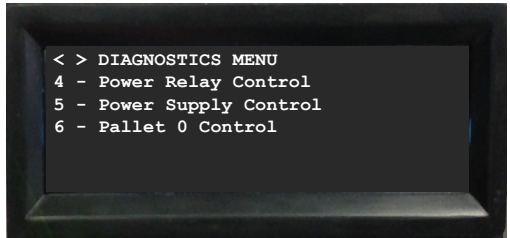
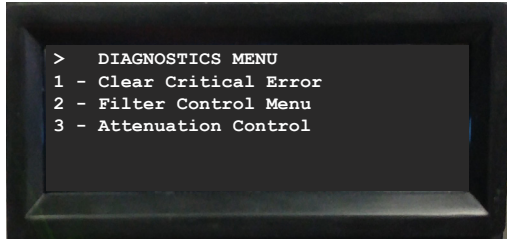



1 - Clear Critical Error

Select Clear Critical Error, when the error raising the alarm has been fixed. This will reset the Error State. See page 9 for further information.

2 - Filter Control Menu



Select Filter Control from the Diagnostics Menu to display the following.

Press  or  to move the selection up or down.

Press  or  to toggle the selection on or off.

Press  to display the Confirmation screen.

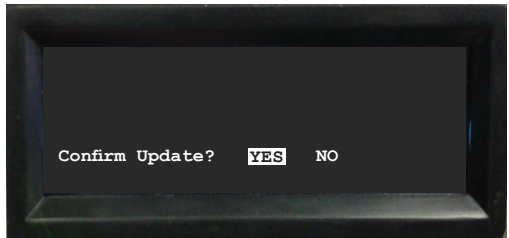
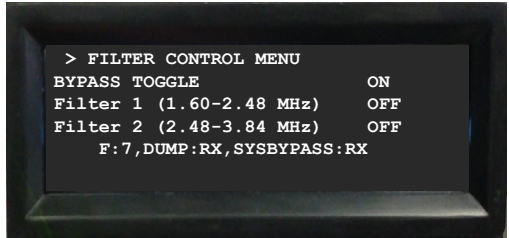

From the Confirmation screen,

press  or  to toggle the selection Yes or No, and return to the previous screen.



3 - Attenuation Control

Select Attenuation Control from the Diagnostics Menu to display the following.

Press  or  to move the selection up or down.

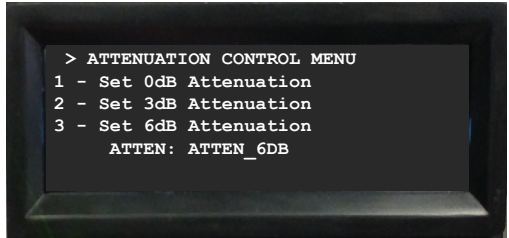

Select > to advance though the menu for more options, or select < to return to the previous menu.

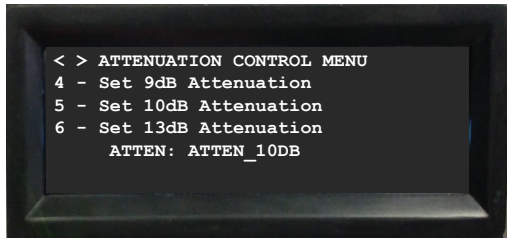

Press  to accept the setting.

The chosen attenuation is displayed on the last line of the display.

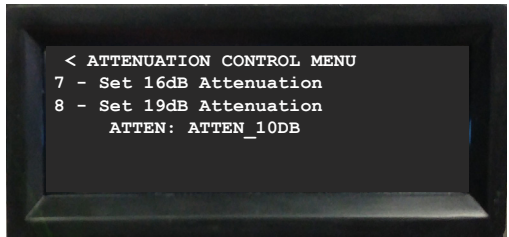

4 - Power Relay Control



Select Power Relay Control from the Diagnostics Menu to display the following.

Enables or disables the external 48 V Power Supply.

Press  or  to toggle the selection on or off.

Press  to display the Confirmation screen.

From the Confirmation screen,

press  or  to toggle the selection Yes or No, and return to the previous screen.

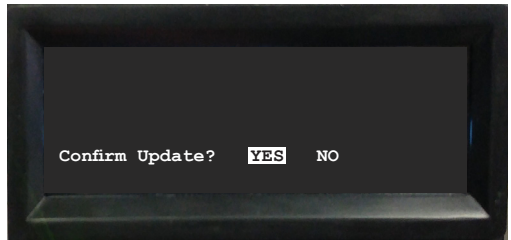
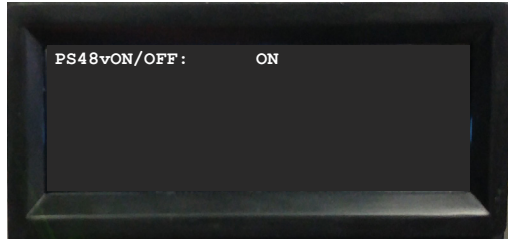



5 - Power Supply Control

Select Power Supply Control from the Diagnostics Menu to display the following.

The external power supply consists of three modules.

Use this menu to enable or disable the individual modules.

Press  or  to move the selection up or down.

Press  to accept the setting.

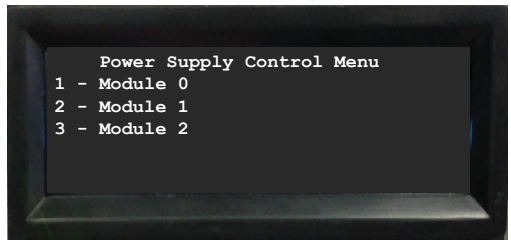

6 - Pallet 0 Control

Select Pallet 0 Control from the Diagnostics Menu to display the following.

The Power Amplifier consists of two pallets.

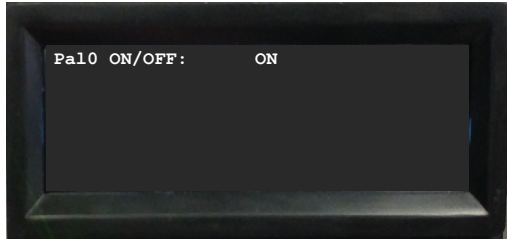

Use this menu to enable or disable Pallet 0.



Press  or  to toggle the selection on or off.

Press  to confirm and display the Confirmation screen.

From the Confirmation screen,

press  or  to toggle the selection Yes or No, and return to the previous screen.

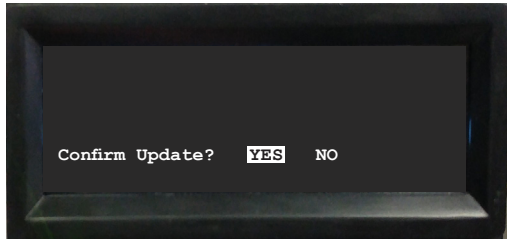

7 - Pallet 1 Control

Select Pallet 1 Control from the Diagnostics Menu to display the following.



The Power Amplifier consists of two pallets.

Use this menu to enable or disable Pallet 1.

Press  or  to toggle the selection on or off.

Press  to display the Confirmation screen.

From the Confirmation screen,

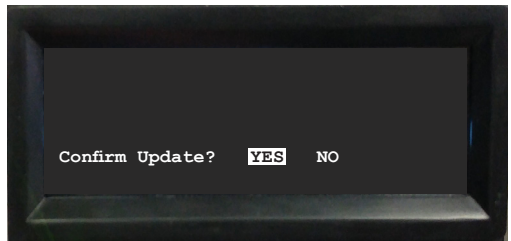
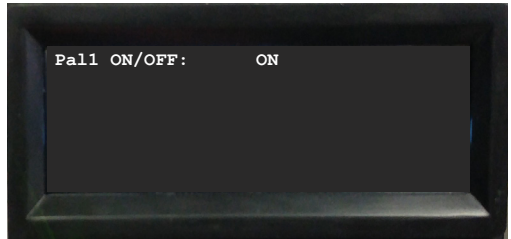

press  or  to toggle the selection Yes or No, and return to the previous screen.



8 - Fan Control Menu

Select Fan Control from the Diagnostics Menu to display the following.

The Fan Control menu enables the three fans to be switched on or off independently or together.

Press  or  to move the selection up or down.

Press  or  to toggle the selection on or off.

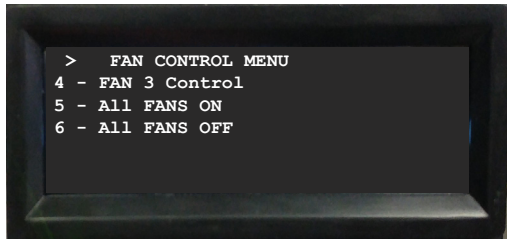
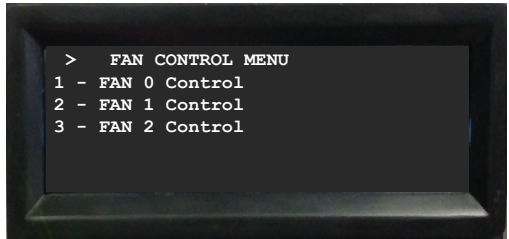



The illustration opposite shows that the status of Fan 0 is on.

Press  or  to toggle the selection on or off.

Press  to display the Confirmation screen.

From the Confirmation screen,

press  or  to toggle the selection Yes or No, and return to the previous screen.

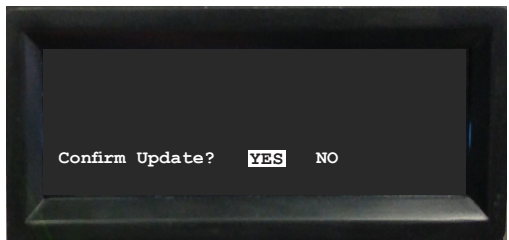
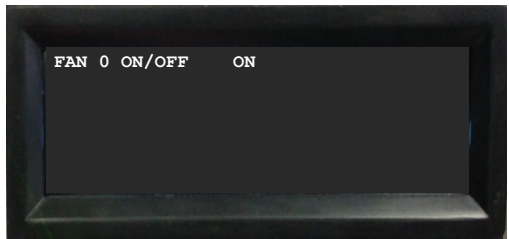



9 - Pump Control

Select Pump Control from the Configuration Menu to display the following.

Press  or  to toggle the selection on or off.

Press  to display the Confirmation screen.

From the Confirmation screen,

press  or  to toggle the selection Yes or No, and return to the previous screen.

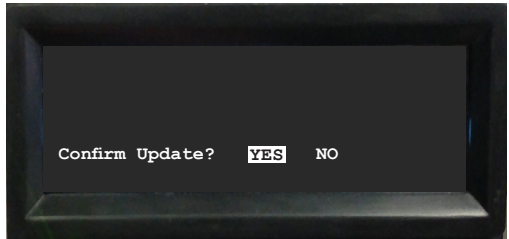
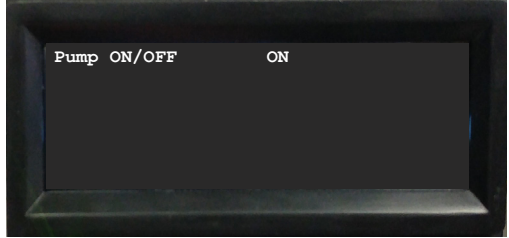

10 - Bypass Lock On Control



Select Bypass Lock On Control from the Diagnostics Menu to display the following.

Use this menu to enable or disable the Bypass Lock.

Press  or  to toggle the selection on or off.

Press  to display the Confirmation screen.

From the Confirmation screen,

press  or  to toggle the selection Yes or No, and return to the previous screen.

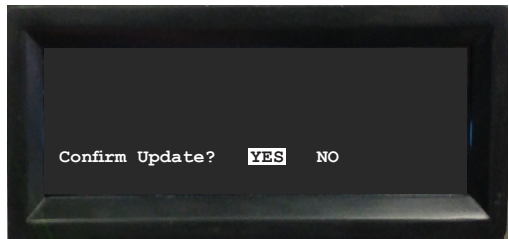
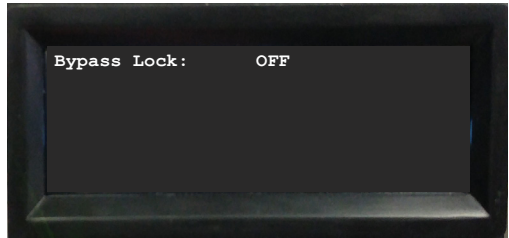

Installation and Setup

Safety



Lethal AC and RF voltages are present within the cabinets of the Barrett 4075 solid-state Linear Amplifiers and the Barrett 4075 Power Supply Unit.

The proper, safe installation of the Barrett 4075 solid-state Linear Amplifier is not difficult to accomplish if the following guidelines are followed:

All electrical work should be undertaken by a suitably qualified person and in accordance with local bylaws.

Use extreme caution when opening the cabinet(s) to perform any alignment or adjustment steps, and take particular care to inspect interconnection cables frequently to ensure that they are in good condition.

The Linear Amplifier units are heavy! Proper lifting techniques are recommended when installing the Power Amplifier and Power Supply units.

A suitable minimum 3 kVA rated Line Conditioner unit is required to ensure protection for the Power Supply unit against unstable mains supply. Failure due to mains power fluctuation and no Mains Line Conditioning unit employed will not be considered as a warranty repair.

Suitable Lightning Protection and Earth connection is essential to minimize or prevent lightning induced damage of the Linear Amplifier. Barrett Communications Earthing Kit (P/N BCA207503) is suitable for this purpose. Lightning induced damage is not considered a warranty repair.

Getting Started

The new 4075 system is shipped with the Linear Amplifier removed from the rack. All other units are fitted and factory adjusted for optimum operation. All vacant slots are covered.

Mains Connection

Once the rack is located in its final position and secured to the floor, unwrap the internally fitted orange mains cable and feed it out of the cabinet either at the bottom or through the top cable access point and connect to a suitable mains source.

The 4075 high power transmitter systems are usually built into either the 20RU or 39RU racks. Each system includes an AC power distribution box BCA407520. Connection of mains power into this box is via a six metre long mains cable which is directly terminated into the AC power distribution box. The other end of this cable is left unterminated for hard wire connection to a customer's mains supply through a suitable high current termination. This termination should be performed by a suitably qualified electrician. Barrett Communications recommend that a dedicated RCD is used in this circuit.

Please note that the peak current drawn by the 4075 system exceeds normal wall socket ratings and so connection through a wall socket is not safe and should be avoided.

According to Australian / New Zealand Standards, the mains cable conductor colour code is as follows:

Conductor colour	Designation
Brown	Active
Blue	Neutral
Green/Yellow	Earth

All Barrett equipment is automatically able to operate with mains input voltage range of 100 to 250 V AC. However, the system mains supply cable for mains voltages below 200 V AC needs to be adjusted for the heavier current with the following typical specifications:

Voltage	Power	Current Draw
240 V AC	1000 W	20 A peak
240 V AC	500 W	16 A peak
110 V AC	1000 W	40 A peak
110 V AC	500 W	25 A peak

For mains voltages 250 – 200 V AC,
the mains supply cable has conductors of 2.5 mm²

For mains voltages 200 – 100 V AC,
the mains supply cable has conductors of 4 mm²

By default, the cable type supplied with 4075 systems is for the higher mains voltage range. A special requirement needs to be ordered for low mains voltage systems.

Ground (Earth) System

The ground (earth) system is a key part of the overall system and consequently of the system performance. An inadequate ground system is the primary cause of poor system performance, noise and lightning damage. When an ATU is fitted, the system ground will include a ground counterpoise which is essential for ATU tuning performance.

Land System Grounding

The following major aspects should be considered when installing a land based station grounding system:

- Rack and equipment ground with respect to the mains supply and personal safety is paramount. The installation of all electrical equipment should be in accordance to local bylaws, and grounding is a requirement for effective earth leakage protection.
- Grounding with respect to EMI (Electro Magnetic Interference): Due to the high RF fields in the proximity of the transmitter rack, shielding of all equipment and cables is important. Each Rack Mounted main item is connected to the rack vertical ground strip via flexible straps. The supplied system rack and cables have been adequately shielded. The ground point for external connection can be found at the rear bottom of the rack. The rack earth connection should be extended, as directly as possible, to a suitable ground, outside of the building, using preferably, a 50 mm copper earth strap. All signal cables should be shielded and grounded at each end.
- Lightning protection also requires a good ground connection and should be similarly connected to the building ground. The lightning protection should ideally be located where the coaxial cables enter the building, and coupled to ground as directly as possible.
- When an unbalanced antenna or an ATU is used, the antenna ground, or counterpoise is vitally important. Providing an adequate counterpoise at ground level is difficult, but it is far more difficult when the ATU is placed on a roof top. At ground level, the use of 8 to 12 radial wires of 16 gauge or larger, each of about 1/3 longer than the length of the antenna, buried to about 150 mm below the surface should be adequate. (Radial earth mat / ground plane: Barrett P/N BCA20026) Connection to metal water pipes can also improve the ground. On a roof top, there is usually not enough space for an adequate counterpoise. An effective counterpoise may be achieved by covering the entire roof surface below the antenna with wire mesh which is then connected to the ground as directly as

possible. It must be noted however, that the successful tuning of the ATU and the resulting VSWR performance of the antenna, will greatly depend on the effectiveness of the counterpoise provided.

Marine System Grounding

Metal hulled vessels provide an almost perfect ground. The tuner ground terminal should be connected directly to the hull using the shortest possible ground strap. The point of connection to the hull should be prepared so that it is free of paint and rust to ensure a good contact area with minimum electrical resistance.

Wooden or fibreglass vessels present more of a problem to ground. Ideally the vessel should be fitted with an external copper ground sheet, connected to the interior of the vessel by suitable stud or an earth plate ("E" plate Barrett P/N BCA91700).

If the vessel is yet to be constructed, then in the case of fibreglass vessels a thin copper sheet with an area of not less than 4 square metres should be moulded into the hull during lamination. A suitable heavy strap should be connected to the sheet and left free for earth connection.

Should neither of these methods be available, it will be necessary to bond as many large metallic objects, such as the engine and propeller shaft, together to form a ground.

Whichever method is used, the ground run from the ground system to the antenna tuner should be as short as possible and copper strap at least 50 mm wide (wider if available) should be used.

Corrosion

All connections in marine situations are subject to corrosion and oxidation. To minimise this, all joints should be cleaned and have silicon grease applied before assembly. Under severe conditions, joints should be protected with self vulcanising rubber tape. Consideration must always be given to the problem of electrolysis. Severe structural damage may occur if electrolysis is present.

Antenna Connection

The 4075 system can only perform well when a suitable antenna, in good condition, is installed. There are many antenna types available on the market, and so no specific antenna detail is provided in this manual. Please refer to the instruction brochures for the antenna type selected. Please note that a VSWR of $< 2:1$ is desirable for optimum performance of the Linear Amplifier.

We suggest that for high power transmitters, a type RG-213 or better cable is used for all coaxial feeds beyond the Linear Amplifier. For improved coaxial feeder performance over long runs, we suggest the use of a low-loss coaxial cable. Our Technical Services department can assist with cable selection if required. The use of a lightning protection module is recommended.

Fitting the Linear Amplifier

Unpack the Linear Amplifier and refer to the connection diagrams shown below. Unless otherwise specified for special project requirements, all cabling with the exception of the coaxial RF output cable, are installed in the rack and so identification and connection is straightforward.

Both the 4075 Linear Amplifier and the 4075 Power Supply units have been factory adjusted for optimum performance.

4050 Transceiver Setup

Important: The 4050 Transceiver must be specifically set for use with a Linear Amplifier. It is important that the "Antenna Type" selected within the "I/O Settings" menu of the Transceiver, is set to "4075 Linear Amplifier". In this mode, the output power of the Transceiver is limited to between 30 W and 80 W, and the Automatic Level Control (ALC) voltage is sourced from the Linear Amplifier.

Please refer to the 4050 HF SDR Operating and Installation Manual (P/N BCM40500) for comprehensive details on operating the Transceiver.

4075 System Connections

The BC407500 - 1000 W Transmitter may be located in an 18RU desk mounted rack cabinet or 39RU floor mounted rack cabinet.

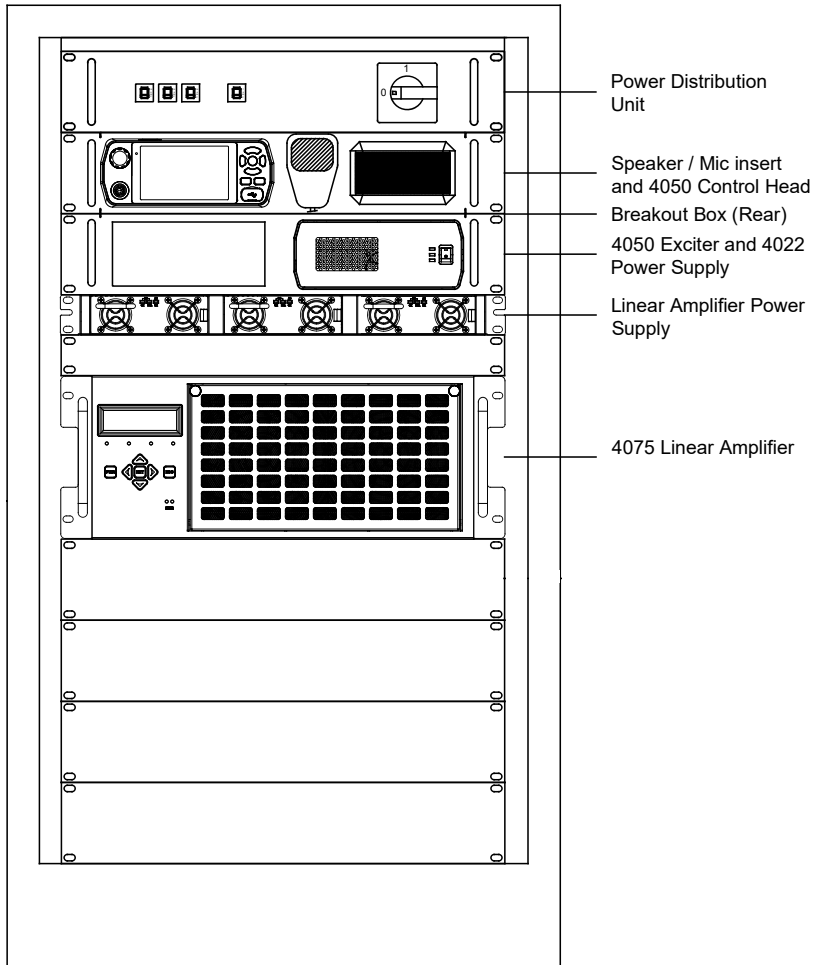

4075 Connections - Rear View

Internal rack cable connections are indicated in the following drawing:

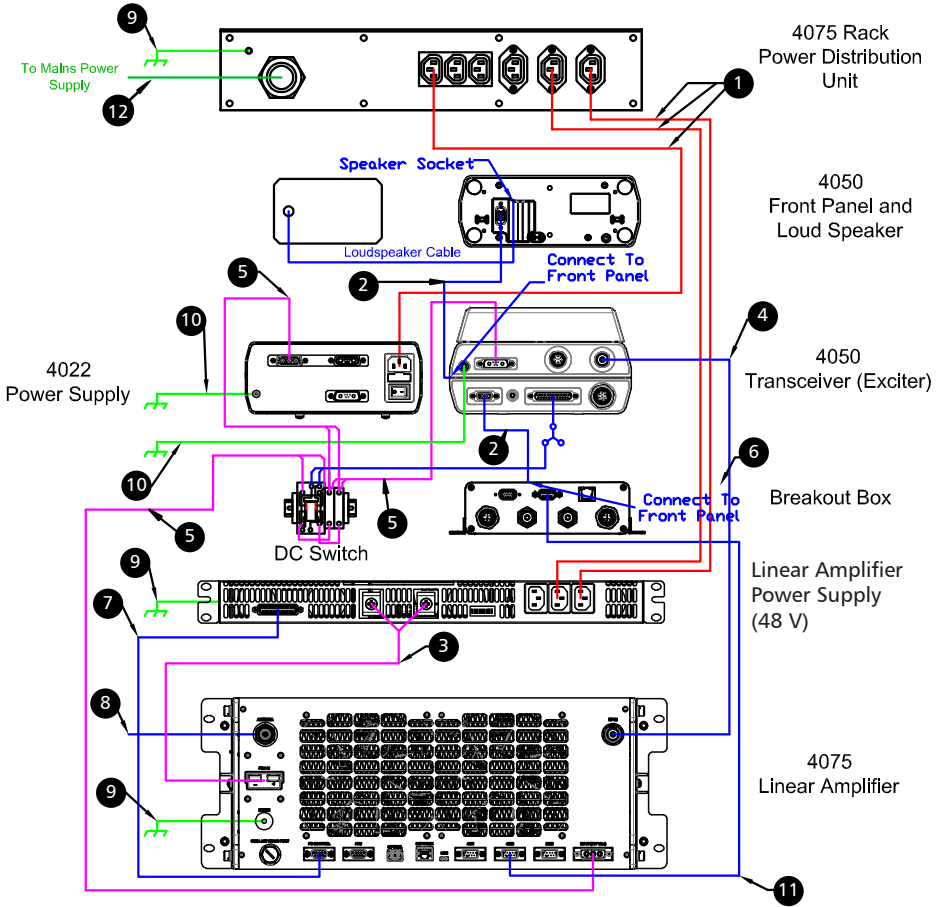

- 1 IEC power cable C14 to C13 1 m
- 2 DE15F to DE15M cable 1.2m
- 3 4075 DC power cable
- 4 Coax lead PL-259M to PL-259M
- 5 DC power cable
- 6 Accessories DC power cable
- 7 4075 Linear to PSU control cable
- 8 Coax lead N-type M to PL-259M
- 9 Earth strap
- 10 Earth strap
- 11 DB9M to DB9F cable 2.5ft
- 12 Mains connection

System Description

The 4050 Transceiver sends the transmission frequency to the Linear Amplifier which sets the appropriate low pass filter.

In Standby (Receive) Mode (No PTT)

In standby mode, the RF signal at the antenna bypasses the Linear Amplifier and goes straight to the Transceiver. The Transceiver's demodulated audio is available from the external speaker fitted to the rack.

In Transmit Mode (PTT Active)

The PTT signal from the Transceiver is passed via the Breakout Box to the Linear Amplifier where it is used to set the Linear Amplifier to "Transmit". The Linear Amplifier then routes the RF signal through the power amplifier stages, the Low Pass Filters (LPF) and ALC detection circuit, to the antenna connection. The ALC voltage produced in the Linear Amplifier is passed back to the Transceiver via the Breakout Box. The ALC voltage is used to monitor the VSWR condition of the load and consequently reduces the output power of the Transceiver, in the event of a fault condition.

Operation Settings

Factory Settings

All unit settings have been factory preset for optimum performance. No internal adjustments are required.

System Settings

As with any system, user specific settings are required. Most user settings are made through the front panel of the 4050 Transceiver. Please refer to the 4050 HF SDR Operating and Installation Manual (P/N BCM40500) for comprehensive details of functions available.

Please note that there are some important settings which should be checked prior to keying the system for the first time:

- The 4050 Transceiver's "Antenna Type" must be selected within the "I/O Settings" menu to "4075 Linear Amplifier".
- The 4050 Exciter Transceiver must be programmed with appropriate frequencies and operating parameters including the power setting. Please note that the RF transmit power level should be set to 125 W, if the output power of the Linear Amplifier is 1000 W.

Receiver checks can now be performed. The receiver is identical in operation and function to a stand alone 4050 Base Station Transceiver. The 4075 Linear Amplifier, in bypass or fail state, will pass the received RF signal directly through to the 4050 Transceiver.

Only after the above has been checked, can you proceed to perform Transmitter checks.

In SSB mode, the transmitter will only produce power when modulation is present. The front panel of the 4075 Linear Amplifier can display both the forward power and VSWR via display menus (see page 8).

The Linear Amplifier will not tolerate poor antenna matching when the VSWR is greater than 3:1. If this occurs, the Linear Amplifier will fold back the power so less power is transmitted.

This will continue to fold back as VSWR increases. At >5:1 the power will be half. As the VSWR approaches 6:1, the Linear Amplifier will trip out with a VSWR error and enter bypass mode

The antenna and feeders need to be in good condition, and where an ATU is fitted, the antenna and counterpoise must be adequate. The performance of the system relies entirely on the condition of the antenna.

A simple test to prove transmitter performance is to use the "Tune" function of the Transceiver:

- Tap and hold "Tune" on the front panel of the 4050 Transceiver and note the readings of the forward power and VSWR displayed on the 4075 Linear Amplifier (see page 8). This should be performed for each of the programmed frequencies.
- If an ATU is fitted and "Tune" is tapped, the system will invoke a tune cycle. Once the ATU has attained a tune pass, additional "Tune" tapping will produce the same results as above.

If Selcall is enabled, send a Selcall to ensure the correct modulation to achieve full output power indication.

Note: As the Transceiver's antenna type has been set to "4075 Linear Amplifier", if an external through-line power meter is used to measure the RF power out of the 4050 Transceiver, the Transceiver will NOT produce 125 W output power. A measured reading between 50 W and 80 W is likely to be present at the antenna output of the Transceiver, when "Tune" is invoked.

Maintenance

This unit requires low maintenance. Regular attention to the condition of all external cables and connections is recommended, especially where the cables are exposed to unfavourable weather conditions.

4075 - Specifications

Please note these details are subject to change.

General

Specification	Description
Power Output CW	1 kW \pm 1.5 dB
Frequency Range	1.6 ~ 30 MHz
Input Power for Rated Output	10 W
Power input	10 W min ~ 100 W max, step attenuated
Power Gain	+25 dB
Gain Flatness	\pm 1.5 dB
Duty Cycle	100%, Continuous PEP, CW
Input Return Loss (S_{11})	-15 dB Max
Third Order Intercept (IP3)	+75 dBm
Harmonics	> -55 dBc (2 to 30 MHz)
Non harmonic products	> -70 dBc (2 to 30 MHz)
Intermodulation Distortion	> -30 dBc
ALC Voltage (output)	0 ~ 10 V
T/R Switch Isolation	-30 dB
T/R Switch Time	15 ms Max
Filter switching time	15 ms Max
Filter Type	LPF
LPF band cutoff frequencies	2.48, 3.84, 6, 9.3, 14.5, 20, 30 MHz
Power Requirements	48 V DC @ 60 A, 12 V 24 V DC @ 2.5 A max
BITE	Microprocessor controlled
MTBF	11.01 k Hours
MTTR	0.5 Hour (Level 2 maintenance, intermediate - faulty board identification and replacement)

Mechanical

Specification	Description
Dimensions excluding handles and I/O connectors	178 x 482 x 480 mm (7" x 19" x 19") – H x W x D
Rack Height	4U, 19" Rack mount
Weight	30 kg (66 lbs)
Cooling	Liquid cooled, Water Propylene Glycol mixture
Colour	Black

Environmental

Specification	Description
Temperature	10°C to +50°C operational, -40°C to +85°C storage
Humidity	95% relative, non-condensing
Altitude	3000 m above sea level (not airborne), 9000 m transportation
Vibration	Designed to meet MIL-STD-810G Method 514.5
Shock	Designed to meet MIL-STD-810G Method 516.6
EMI/EMC	Designed to meet MIL-STD-461F
FCC	Pending approval

Controls and Indicators

Specification	Description
Switches and controls	7 Key keypad – ON/OFF, and menu navigation
Graphic display	Dot matrix OLED display
Metering	Output VSWR, Supply Voltage and Supply Current
Indicators (LEDs)	Power, Tx, Alarm, Log

Connectors (Front)

Specification	Description
Micro USB A/B	System Interface – Status, BITE, Settings, Firmware upload

Connectors (Rear)

Specification	Description
UHF SO-239 (MIL-C-4914)	RF Input
Type N or 7/16 (option)	RF Output
D-Sub 15	2050 Legacy interface
D-Sub 15	PSU Control
D-Sub 9	4050 SDR Interface
D-Sub 9	ATU Control
D-Sub 9	Auxiliary Control
D-Sub 3W3	4022 PSU
Micro USB Type A/B	Programming interface
Optical Multi-mode Fibre SFP	ATU Control
RJ45	Ethernet
Anderson SBS75X	DC Power input

Protection

Specification	Description
	Linear amplifier bypass on overload
Input Overdrive	> 10 W (at 0 dB input attenuation)
Output VSWR	>3:1 Power Fold Back; >6:1 Bypass
Thermal Overload	> 135°C Pallet
Fault Log	System events and error reporting

Limited 3 Year Warranty Statement

Barrett Communications Pty Ltd provides a maximum three year warranty on all equipment it manufactures which is to be used expressly for high frequency, single sideband radio communications. This warranty covers faults arising from defects in design, workmanship or materials. Please note that this warranty does not cover batteries.

Should any fault due to bad design, workmanship or materials be proven at any time within the warranty period, the company will rectify such fault free of charge providing the equipment is returned freight paid to Barrett Communications Pty Ltd head office or to an authorised service centre. The warranty period for all products is thirty six (36) months after date of shipment from the factory.

In the event that Barrett Communications repairs or replaces a defective product part under warranty, the repaired or replaced product will remain covered under and throughout the term of the original warranty period up to its expiration. No repair or replacement will extend the warranty term past the original thirty six (36) month anniversary of the original shipment delivery date of the Barrett Product.

This warranty shall not cover any abuse, accident, improper installation, connection, adjustment or use other than in accordance with the instructions issued by the company.

In addition, this warranty shall not cover the distance which transceiver products will operate over or quality of transmission or reception as a result of unfavourable environmental conditions. Nor shall this warranty cover the quality of transmission and reception of transceivers mounted in vehicles or vessels that have not been sufficiently electrically suppressed.

Subject to the matters set out in this warranty, no liability, expressed or implied is accepted for any consequential loss, damage or injury arising as a result of a fault in the equipment and, all expressed or implied warranties as to quality or fitness for any purpose are hereby excluded.

This warranty does not extend to products supplied by the company which are not designed or manufactured by it. Barrett Communications Pty Ltd will however make every endeavour to ensure that the purchaser receives full benefit on any warranty given by the original equipment manufacturer.

This warranty is restricted to the original purchaser. Where the original purchaser is a reseller who has purchased for the purpose of resale, warranty shall be extended to the reseller's customer.

Warranty Registration and Technical Support

Thank you for purchasing Barrett HF communications products.

Please complete the warranty registration form on the next page and send it to us by mail, fax or email. Please see contact details below.

Once received your contact details will be registered against the serial numbers of your equipment and Barrett Communications will then be able to contact you if needed to keep you informed of any developments relating to your equipment.

If you have access to the Internet you can use the warranty registration page in the tech support section of our website to register your warranty form. Please go to www.barrettcommunications.com.au/Support.html

Barrett Communications is proud of its reputation for support of its customers. This registration process has been introduced so that we may continue to improve our level of support to you.

Warranty Registration Contact Details

By Mail The registration forms can be returned by mail, (no postage stamp required in Australia)

Facsimile 08 9418 6757 (International +618 9418 6757)

Email support@barrettcommunications.com.au

Our customer / dealer technical support department can be contacted via land mail, email, telephone or with the support department contact form on the tech support web page.

Barrett Communications Pty Ltd Head Office:

PO Box 1214, Bibra Lake WA 6965 AUSTRALIA

Toll Free Tel: 1800 999 580 (Within Australia)

Tel: +618 9434 1700

Fax: +618 9418 6757

email: support@barrettcommunications.com.au

Telephone support from the Australian support office is available from 7:30 am to 4:30 pm local time Monday to Friday.

Barrett Communications – Europe:

Unit 9, Fulcrum 2 Victory Park, Solent Way,
Whiteley Hampshire PO15 7FN United Kingdom

Tel: +44 (0) 1489 880 332

Fax: +44 (0) 1489 565 422

email: support@barrettcommunications.co.uk

Telephone support from the UK support office is available from 8:30 am to 5:00 pm local time Monday to Friday.

Barrett Communications Pty Ltd
47 Discovery Drive, Bibra Lake, WA 6163 Australia
Tel: +61 8 9434 1700 Fax: +61 8 9418 6757
Email: information@barrettcommunications.com.au
www.barrettcommunications.com.au