

## Notes on Rebuilding an SB-220 Linear Amplifier (Updated Jul/13)

Brad Rehm, KV5V  
Salado, Texas

Several months ago, I was asked to sell the radio equipment of an older ham who had moved to a retirement home. While it might have been possible for him to obtain permission to operate from his small apartment there, he chose not to deal with the challenges this would have presented. Instead, he ended a forty-year love affair with ham radio and elected to pass his equipment on to newer hams.

We easily found buyers for some of the gear, but it was surprising that a Heath SB-220 amplifier was the last item to sell. Russ, W8BOZ, took it on condition that I replace some of the parts—power supply components, for example—which might begin to fail with age and, most important, that I include some changes which would “modernize” the SB-220. Having rebuilt a Kenwood TL-922 amplifier a year ago, I thought it would be interesting to try a similar exercise on what is arguably a similar amplifier. What follows is an overview of the project, with a few comments about the choices we made.



Photo 1. The Heath SB-220 at the beginning of the project. The outer enclosure has been removed.

A Google search for SB-220 updates returned dozens of articles and reflector comments about this amplifier. So our first step was to download and look through this material to decide which of the changes would be worth making. Three classes of changes emerged: those for convenience, appearance, or endurance, those which improve stability, and those which protect the amplifier against catastrophic failure. Let's look at the ones I chose to install.

Convenience, Appearance, and Endurance Changes. These could be called cosmetic because they don't directly affect the operation of the amplifier. Adding nylon Molex connectors to cable bundles, for example, makes it easier to service the unit when the transformer or the front panel must be removed. The internal appearance of this amplifier, particularly of the tank circuit area, was improved by removing most of the components and cleaning the area with brushes and alcohol swabs. The perforated top and side panels were removed and cleaned with steel wool and abrasives to make them shine again. All of the original wiring was removed and replaced with harnesses made with teflon-insulated wire.

The long-term endurance of the SB-220 can be improved by replacing the fan and adding a step-start circuit. Since this amplifier was thirty years old, I assumed it would better to replace the motor and fan than to simply apply oil to the bearings of the old motor. The original fan blade was nicked in several places, so replacing it might reduce fan noise. Photo 8 shows that I installed longer bolts on the motor so that fender washers could be placed on the inside and outside of the perforated metal on which the fan is mounted. This also helped reduce fan noise and vibration.

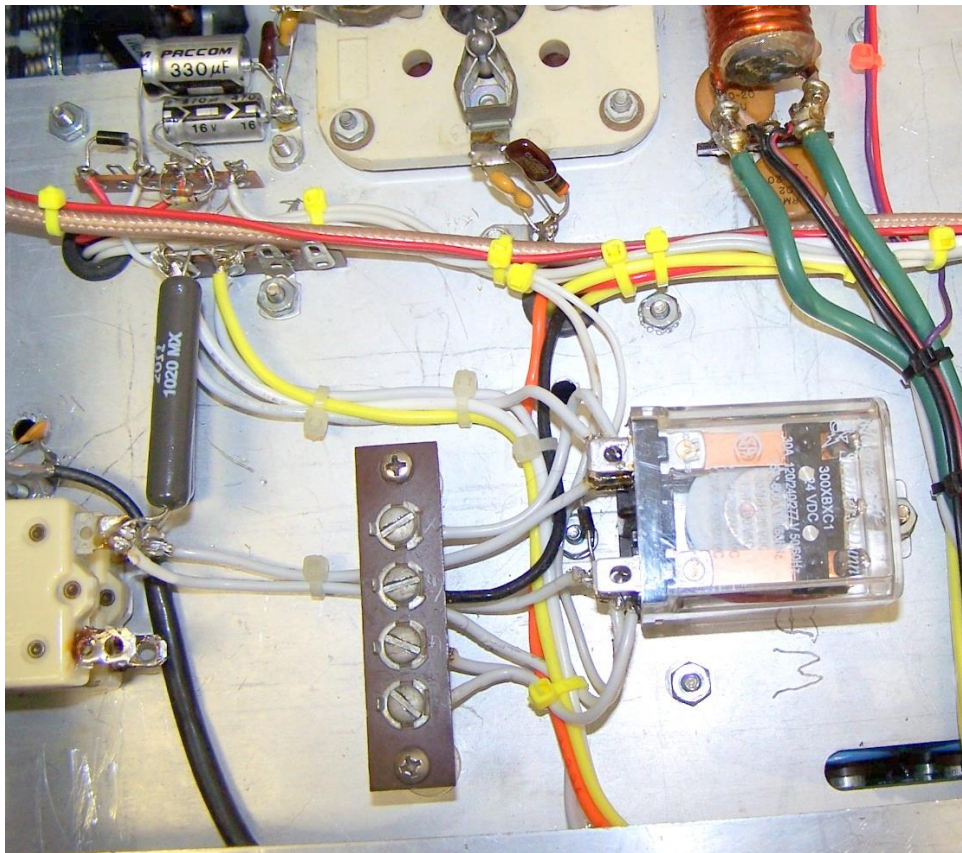

Photo 2. The components of the step-start circuit were located next to the circuit breakers and the power cord entry. The cord and voltage-select jumpers have not yet been installed.

For the final endurance change, we added a step-start circuit which limited the turn-on or inrush current due to the initial low resistance of the tube filaments and the high energy demanded by the filter capacitors when charging begins. I've used two approaches to this task in other amplifier projects. The simplest inserts a negative temperature coefficient (NTC) thermistor in series with one of the incoming AC mains. These devices present a relatively high resistance when cold and reduce their resistance to a small fraction of an Ohm when they become warm. Several commercial soft-start products use this approach.

Another way to accomplish step-start places a resistor in series with one or both of the AC supply leads and uses a relay to shunt the resistors after a two or three second delay. The design of this kind of circuit is a little tricky because the circuitry that energizes the relay may have to work reliably at an initially low AC mains voltage. The resistor values must also be chosen carefully, because we would like them to be suitable for both 120 Volt and 240 Volt operation.

I chose the relay approach, shown in Photo 2 above, using a simple R-C and transistor timer. The start-up current requirement of an amplifier of this size can exceed the current ratings of the largest NTC thermistors, especially when the amp is operated at 120 Volts. The relay approach can be very reliable if the resistors and relay are selected carefully. After a two-second delay, two 15 Ohm, 5 Watt resistors in parallel in each leg of the incoming AC are removed, using a double-pole, 20 Amp relay. The component values allow the simple, 28-Volt delay circuit to operate properly at 120 and 240 Volts.

Photo 2 shows the Magnecraft relay used to bypass each of the series resistors, which are located to the right and above the circuit breakers. The terminal strip to the left of the 3-500Z socket contains the 28 Volt rectifier and delay circuit. The transformer which powers this circuit was bolted to the side panel on the top of the chassis. It is shown in Photos 3 and 12. The final schematic includes the relay control circuit and 28 Volt power supply.

Also in this category were the following convenience and appearance changes:

1. Molex connectors were installed in the high voltage transformer leads and in the wiring to the front panel. These are shown in Photos 3 and 4. The primary connectors were Molex 50-84-1060 and 50-84-2060. The secondary connectors were Molex 50-84-1040 and 50-84-2040.
2. The incandescent lamps which illuminate the meters were replaced with white LEDs. The 5 Volt filament power was rectified and filtered, then current-limited with individual resistors for each LED.
3. Harbach capacitor board was installed in the power supply. In addition to improving the appearance of the capacitor bank, the capacitor board includes new bleeder resistors and adds reverse diodes to protect the amplifier during tube flashovers. The old and new capacitor wiring are show in Photos 5 and 6. Notice the damage to the original transformer secondary lead from arcing through the insulating sleeving in Photo 5.
4. The Harbach SB-220 diode board uses newer 1N5408 diodes, which increase the peak current rating from 1 to 3 Amperes. An additional diode was installed on the back

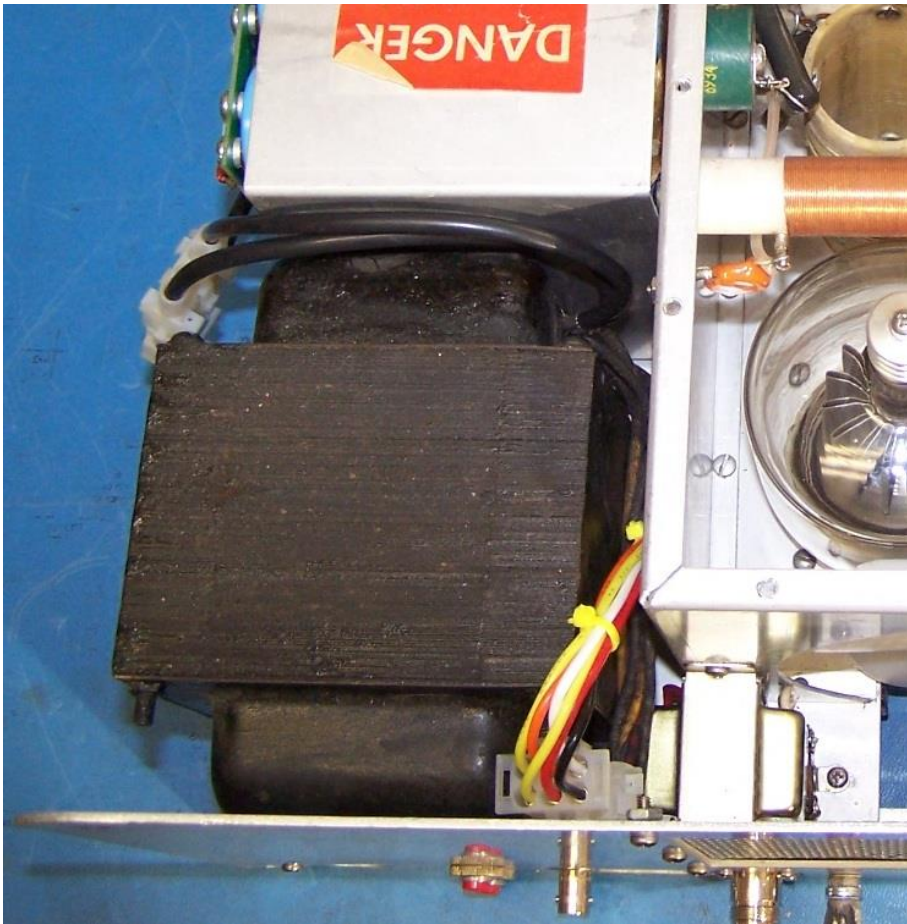

was replaced with teflon dielectric, RG-303.

Photo 3. Molex connectors as installed at the high voltage power transformer. The connectors make it easier to remove the transformer for shipping. The original transformer was replaced with a Harbach/Peter W. Dahl unit, which increased the available high voltage from about 3200 to nearly 3500 Volts. This photo also shows the Alpha Wire sleeving which was installed on the transformer secondary leads. The breakdown rating of the sleeving is 8000 Volts.

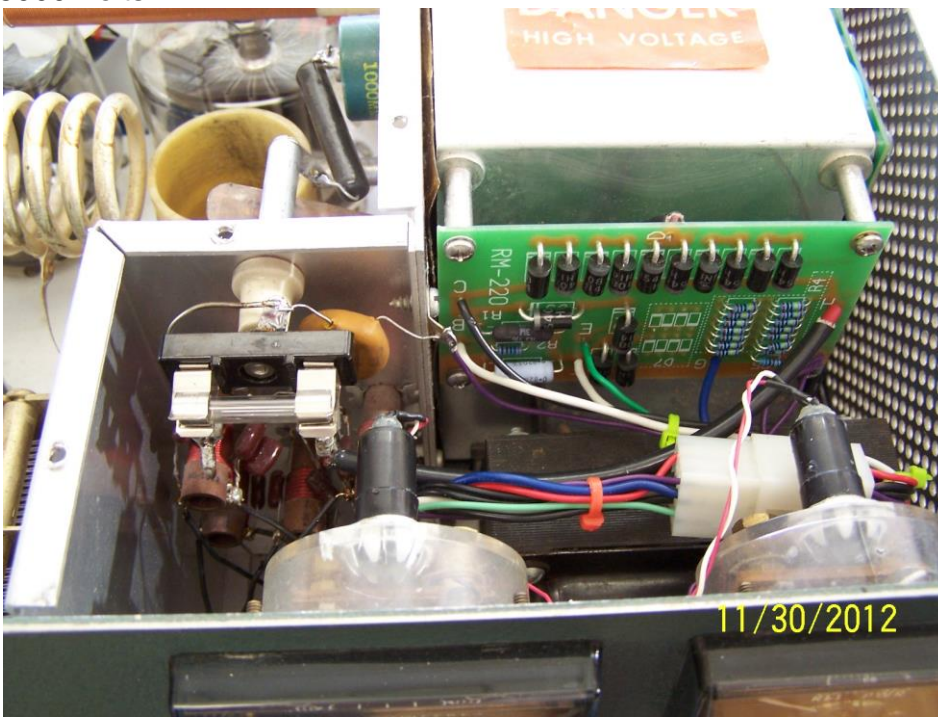

Photo 4. The Harbach diode board, which replaces the original voltage doubler board. The area of this board which contained the zener diode replacement is not populated because this function is performed by the W7RY QSK Board. Also visible in this photo is the Molex connector which allows detaching and removing the front panel. The fuse, visible

- of the board to reduce the chance of damage from tube flashovers. (See the discussion of this change below.)
- 5. The ALC circuitry was removed because reliable ALC loops are already incorporated in modern transceivers.
- 6. The three-pole antenna- and bias-switching relay was discarded, and several components were added to replace it. The vacuum relays are shown in Photo 7. The upgrades accomplished with the W7RY QSK Board are discussed below. All coax in the SB-220

on the left side of the photo, protects the power supply and meters from tube flashovers. Not visible here is the diode recommended by W8JI to provide additional flashover protection for the meters. It has been soldered to the back of the diode board between terminal C and ground.

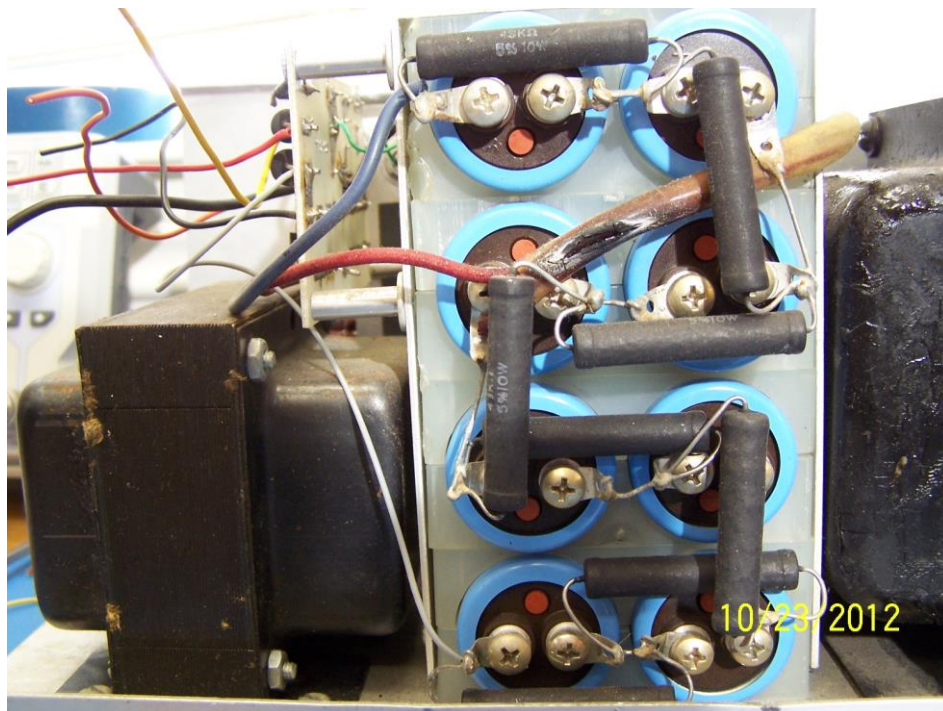

Photo 5. The original capacitor and diode board wiring. Notice the arc damage to the original transformer secondary wire and sleeving.

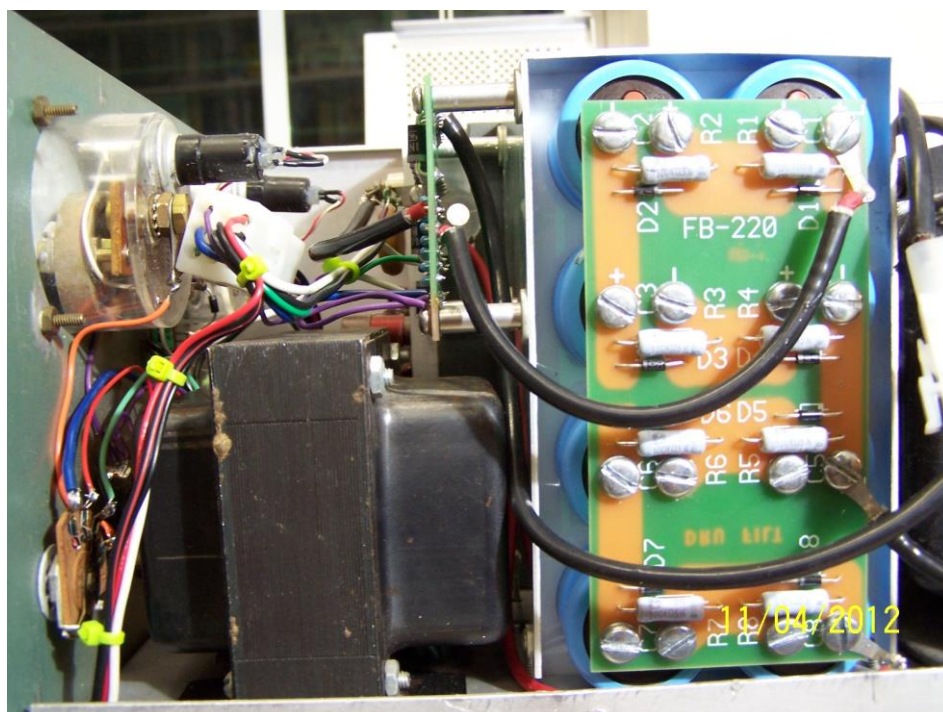

Photo 6. The Harbach capacitor and diode boards replaced the original wiring and PWB. Alpha Wire sleeving was used on all the high voltage wiring. The new front panel wiring and

white meter LEDs are also visible in this photo.

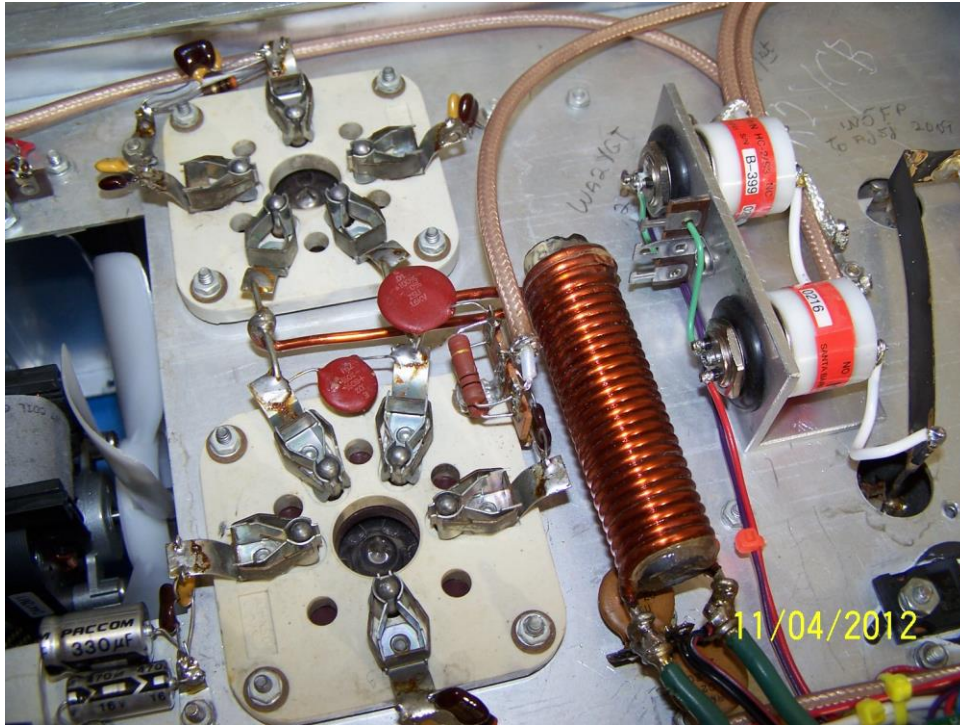

Photo 7. Kilovac HC-2 vacuum relays are shown in this photo. The resistor which sets current through the relays at 60 mA will be installed on the terminal strip between the relays.

The relays are mounted in rubber grommets (Mouser 534-750) to reduce mechanical switching noise. Also visible in this photo are the parallel 10 Ohm resistors in series with the coax and RF drive to the filaments. These reduce the Q of the bandswitch-to-tube wiring.

Improvements for Stability. Some SB-220s tended to develop parasitic oscillations, particularly when used on the higher HF bands. This problem appeared not only in the Heath amplifiers but in a number of competing production amps of the same vintage. The parasitic suppressors placed in series with each of the tube plate leads are usually responsible. You will find a variety of opinions about how suppressors should be built. Many designers feel that the three-to-five turn inductors around or adjacent to Q-killer resistors do not make good parasitic chokes. Even though the Q of these chokes can be made low, the fact that they're typically resonant in the VHF range means that they can support parasitics.

Hairpin loops shunted by low-inductance resistors have self-resonant frequencies well above the VHF range and appear to work well as parasitic suppressors. The loops are typically just wide enough to allow the resistors to be soldered across the bases, and they are made somewhat longer than they are wide. I haven't seen the loop dimensions fully-defined yet, but Richard Measures, AG6K, gives a fairly complete description in his on-line paper on the TL-922 and the SB-220. (See the "Anode Circuit Modification" section of <http://www.somis.org/QSK922.html>.) Although Measures also recommends using nichrome wire for the loop, I have found 12-gauge, tinned buss wire to be satisfactory. Photo 8 shows the hairpin loops installed in this SB-220. Observing the output of the amp with a spectrum analyzer, I have found no tendency to oscillate, even under a variety of load conditions.

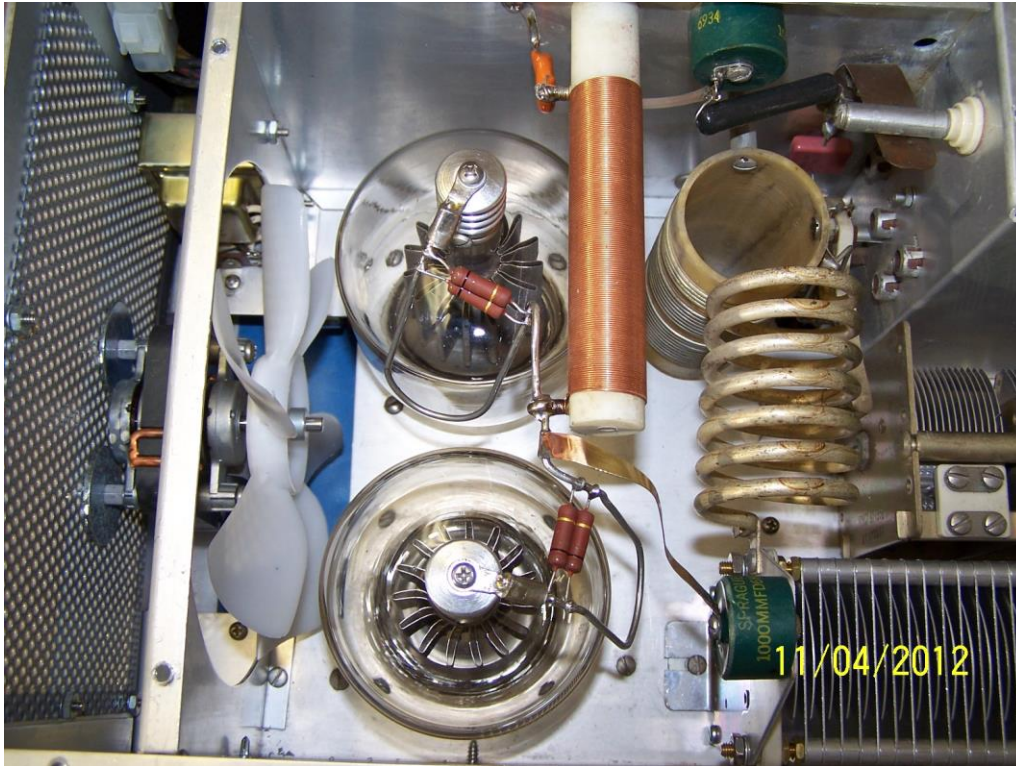

Photo 8. The hairpin parasitic chokes are supported by the plate choke. The Q-killer resistors are placed at the “bottom” of each choke. Notice the ceramic disc capacitor which was added at the base of the plate choke. The new fan and motor are visible to the left of the tubes. The mounting bolts were replaced with longer ones, which permitted using fender washers on the inside and outside surfaces of the intake grill. These reduced motor vibration. The small transformer above the fan motor was later moved to the opposite side of the fan because the space was needed for the larger Peter W. Dahl transformer.

Protecting Against Catastrophic Failure. This category could be subsumed under the stability improvement heading, since some failures are related to parasitic oscillations. I prefer to consider it separately because there is a class of failure which occurs because of sudden discharges inside the tubes. Design choices can't eliminate the chance of a discharge, but they can reduce the damage that follows when a discharge occurs. Tom Rauch, W8JI, has written a technically competent discussion of this phenomenon. (See [http://www.w8ji.com/fault\\_protection.htm](http://www.w8ji.com/fault_protection.htm).) Internal discharges typically occur between the anode (plate) of the tube and the cathode (or filament). When this happens the control grids can be driven positive, causing hundreds of amperes of current to flow through the tubes and their bias circuit. The tubes are lost. The meters are usually destroyed. And many smaller components fail.

The first step in preventing this kind of damage is to abandon the practice of isolating the grids of the tubes from ground with chokes, resistors, or fuses. Photo 7 shows resistors installed between one of the grid terminals on each tube and each grid pin taken to RF ground with pairs of capacitors. These were replaced with buss wire connections to ground. The ground connection ensures that the grids can never be driven very positive in a flashover

event.

Flashovers and damage can occur for other reasons, however, so additional changes were introduced. First, fast-blow, 1 Amp fuses were installed in series with the plate B+ lead and in series with the center tap of the filament transformer secondary. These limit the current which can flow during a flashover event. Second, a diode was installed from terminal C on the diode board to ground. Shown on the schematic, this diode clamps the negative rail, to which the plate current meter is connected, at about 1 Volt.

Finally, a W7RY "QSK Board" was installed to improve amplifier operation and, most important, reduce the chance of a particular kind of failure. Jim offers (or plans to offer) boards for L4B, SB-200, Ameritron, and TL922 amps, as well as for the SB-220. The boards are sold on Ebay (<http://www.ebay.com/sch/radioamplifiers/m.html?ipg=50&sop=12&rdc=1>), but a brief explanation of how the design evolved can be found at <http://www.mentby.com/jim-w7ry-2/tl-922-qsk-boards-now-available.html>.

The original Heathkit design rectified voltage from a separate winding on the filament transformer to develop about 115 Volts DC. This was applied to the antenna/bias changeover relay, and it appeared at the "Relay" connector at the rear of the amp. Modern transceivers are not designed to handle the voltage and current involved, so an interface is normally used to protect the transceiver. The QSK Board rectifies the AC from the transformer and uses a Zener diode to develop 12 Volts for on-board circuitry. The latter includes a transistor buffer which reduces "Relay" current seen by the transceiver to about 10 mA.

The QSK Board includes two other important circuits. One is an adjustable, precision-regulated supply which drives a power-Darlington transistor to control the 3-500Z operating bias. The transmit/standby bias levels are selected by a signal derived from the "Relay" circuit.

The other circuit controls the antenna changeover relays. Jim recommends using a reed relay at the amp input and a vacuum relay at the output. His schematic includes resistors which equalize the currents in the two series-connected relays. Having had unhappy experiences with reed relays in other applications, Russ and I chose to use two Kilovac HC-2 vacuum relays. HC-1s might have been a better choice, but HC-2s were on-hand, and they have worked well in the project as well as several others. Since plenty of voltage is available to operate the series-connected relays, they switch very rapidly. A series resistor limits current to about 60 mA. Adding a capacitor across the resistor could have been used to further reduce switching time, but this was not deemed necessary.

The QSK Board has a role in preventing catastrophic failures in the SB-220, because a failure mode of the Zener diode which controls cathode bias in the original circuit is a short circuit. When the Zener fails in this manner, the tubes are turned fully on, and damage can result when excessive current flows. The QSK Board uses a TIP147 power transistor which is protected by an MOV (a Metal-Oxide Varistor). If the transistor should fail, the voltage across the varistor would rise to its 130 Volt avalanche rating, thus biasing the tubes into cut-off. The normal failure mode for an MOV is to go open, but this only occurs after the part has been driven into conduction many times. The scheme isn't completely failure-proof, but I believe it's less failure-prone than the original circuit. The installed board is shown in Photo 9.



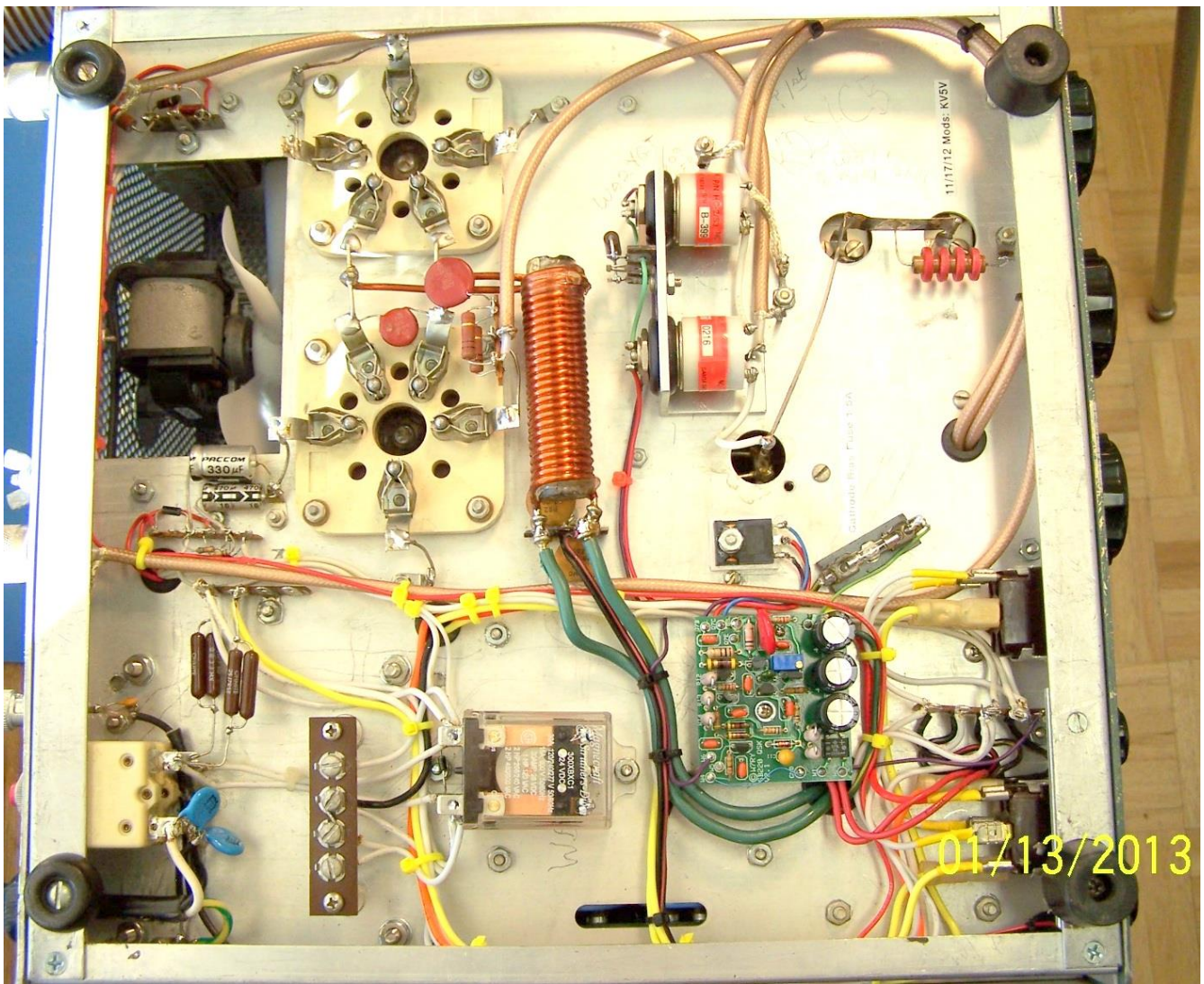

Photo 9. The finished underside of the amp. The QSK Board is on the lower-right in this photo. The Darlington bias-control transistor and filament center-tap fuse are mounted just above it, using available chassis holes.

Final Thoughts. With the exception of a transistor failure on the W7RY QSK board (probably a random failure event), the amp has performed well for several months. Some comments about its behavior are in order:

Substituting the Harbach/Peter W. Dahl transformer for the original high-voltage transformer resulted in several changes in the behavior of the amp. The resting plate voltage increased from an indicated 3200 Volts to nearly 3500 Volts. As a result, less exciter power is required to drive the amp to 1500 Watts output. Prior to the change, 90 to 100 Watts of drive produced about 1400 Watts peak output in SSB mode. After the change, 80 to 90 Watts produced 1400 to 1500 Watts peak output.

These measurements were made using an Array Solutions Power Master wattmeter and a Palstar DL2K load. More importantly, when the the original 3-500Z tubes were replaced with new RF Parts 3-500ZGs, 1500 Watts was attainable with 70 to 80 Watts drive.

When the original tubes were used, other stations reported that transmitted audio sounded better—less distorted—when the drive power was reduced to 75 Watts. At this level, the power output was about 1200 Watts. The new RF Parts 3-500ZGs could be operated at 1400 to 1500 Watts with no degradation in signal quality. Clearly, to keep distortion products under control, we would have to settle for less power output with the original tubes. (The RF Parts tubes were borrowed for testing from another amplifier project.)

Since I am primarily a CW op, I hoped to be able to run the SB-220 at full power from time to time, but I had seen arcing at C55, the plate tune capacitor, at 1500 Watts output. The arcs were actually between the bracket mounted on the back of C55 to support the plate DC blocking capacitor, C29, and the rear shaft bearing. Filing the inner edges of the bracket where it surrounds the shaft bearing eliminated this problem.

On two occasions, idle current and power output fell to half normal. A quick look at the tubes revealed that one filament was not lit. Russ remembered that other SB-220 owners had reported that this can be caused by oxidation on the tube socket pin receptacles. I cleaned the receptacles with Q-tips which had been saturated in an electronic contact cleaner solution. The Q-tips turned dark. The tube filaments have lit reliably ever since.

Photos 10 through 13 show the beginning stages of the project and the finished amp with the Harbach/Peter Dahl transformer installed, with the necessary changes to the enclosure.

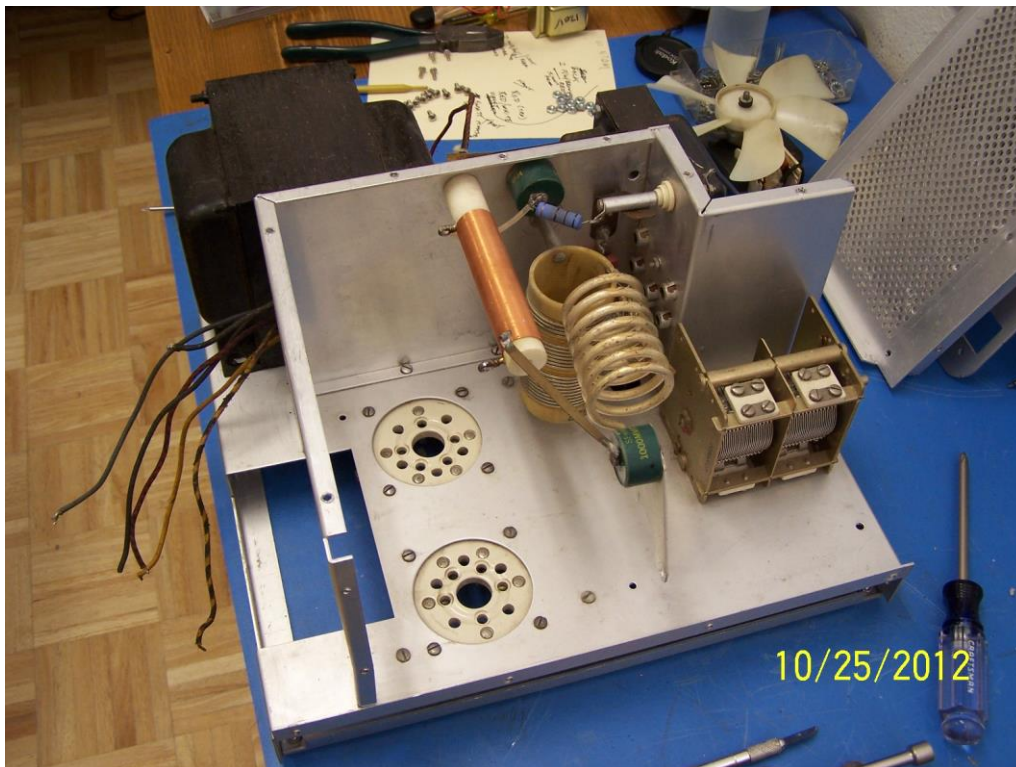
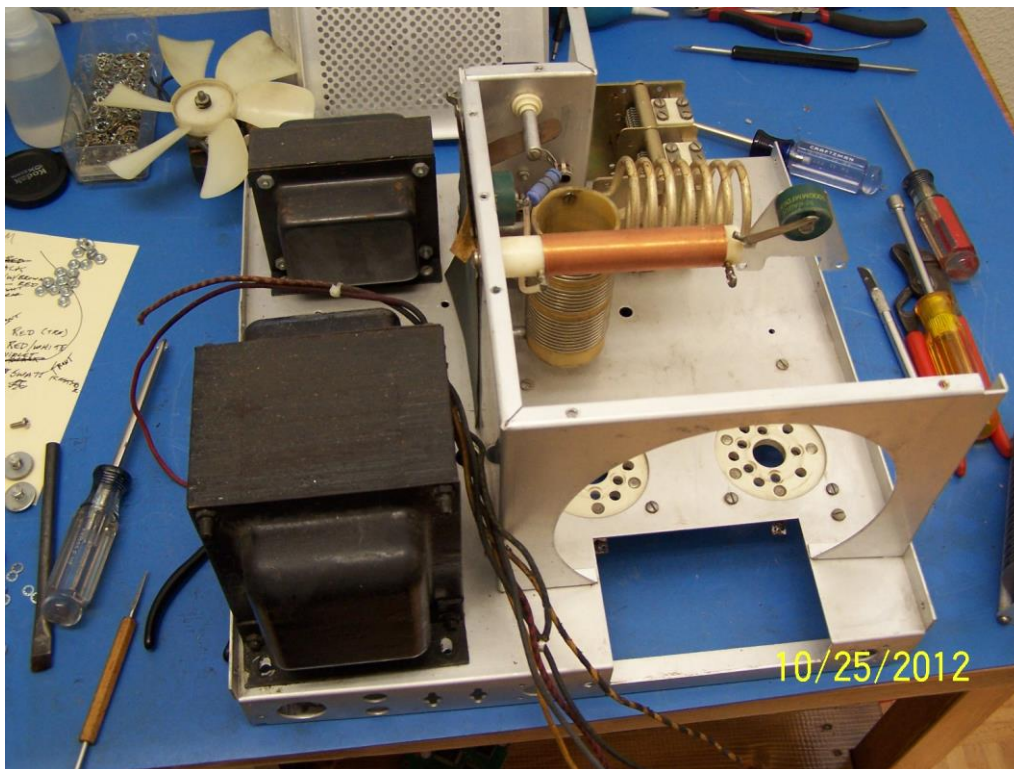

Photo 10. Most components have been removed so that the chassis can be cleaned and old hardware can be replaced. The resistor which feeds high voltage to the bypass capacitor and plate choke was also replaced.<sup>7</sup>

Photo 11. Another view of the chassis, ready for rewiring. One RCA connector on the rear of



the chassis was removed. The other was replaced with a BNC at the "Relay" input.

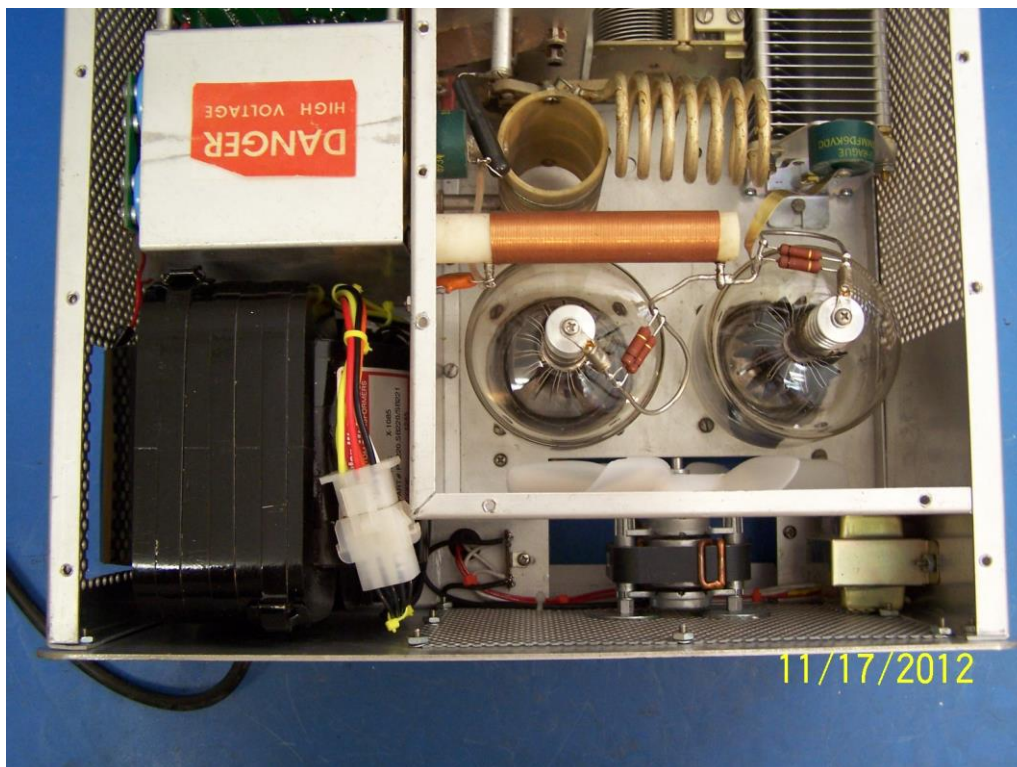

Photo 12. This view shows the Harbach/Peter Dahl HV transformer, which is slightly larger than the original transformer. The 24 Volt transformer which supplies power for the step-start circuit has been moved to the lower-right corner to make room for the Harbach.



Photo 12. It was necessary to cut a rectangular hole in the right-side panel to make room for the Harbach transformer. The transformer will not interfere with the outer enclosure for the amp.

We would appreciate hearing about your SB-220 project. You may have comments about different approaches and better ways of doing what we did. If you'd like to hear the SB-220 in operation, join us and our friends on Saturday and Sunday mornings on 7.138 MHz, 5:15 to 8:00 am, US central time.

73,  
Brad Rehm, KV5V  
(with Russ Gates, W8BOZ)  
1/14/13

Nb. Looking at the schematics after having them scanned at an office supply store, I noticed something which everyone will want to correct. The fuse in the high-voltage line to the plate choke is on the supply side of the Interlock. If the cover plate is removed soon after turning the amp off, the Interlock will try to crowbar the supply, but the fuse will open when the current exceeds 1 amp. This will make the tube compartment safe, but the capacitors in the HV supply will probably not be fully discharged at this time.

The solution: Either remove the Interlock switch and **be careful!** (Bad idea.) Or move the fuse. Install it in series with the HV lead to the RF choke. **Be safe!** (Good idea.)

July 28, 2013: Several changes have been made to the original article, which was posted in January, 2013. Jim, W7RY, suggested a new URL to those who might want to find his products on Ebay. The change has been included in the text.

He also commented that C55, the plate tuning capacitor, should easily handle the voltages developed when the amplifier is driven to 1500 Watts output in CW mode. In fact, adding the QSK board to his TL-922 and SB-220 amplifiers eliminated any tendency to arc (probably because it modifies the turn-on rise time). I responded that I had seen and heard arcing on several occasions *after* installing the QSK board but that I'd found it was not between the plates of the capacitor, as stated in the original article. It was at the back of C55, between the two flanges of the bracket which supports C29, the DC plate blocking capacitor, and the rear shaft bearing.

My solution was simply to file the inner edges of the bracket to increase the spacing between it and the shaft bearing. But it remains that the original writeup was incorrect, because it stated that the voltage rating of C55 isn't high enough to allow operation at legal-limit power. It was also unfortunate that I missed passing this useful information on to readers. My thanks to Jim for his pointing out the error. The text on page 10 has been changed to reflect what actually happened.

Since one of the goals of the project was to prepare the SB-220 for another 30 years of operation, we ultimately chose to replace the 3-500Z sockets. Because of the high filament currents required by these tubes, the pins and socket receptacles tend to increase contact resistance with age. We chose to install sockets distributed by RF Parts Company ([www.rfparts.com](http://www.rfparts.com)).

Finally, I've corrected the misspelling of Harbach Electronics on page 3. For the sake of thoroughness, I should also have included the URL of Jeff Weinberg's fine company: [www.haarbachelectronics.com](http://www.haarbachelectronics.com).

\* \* \*

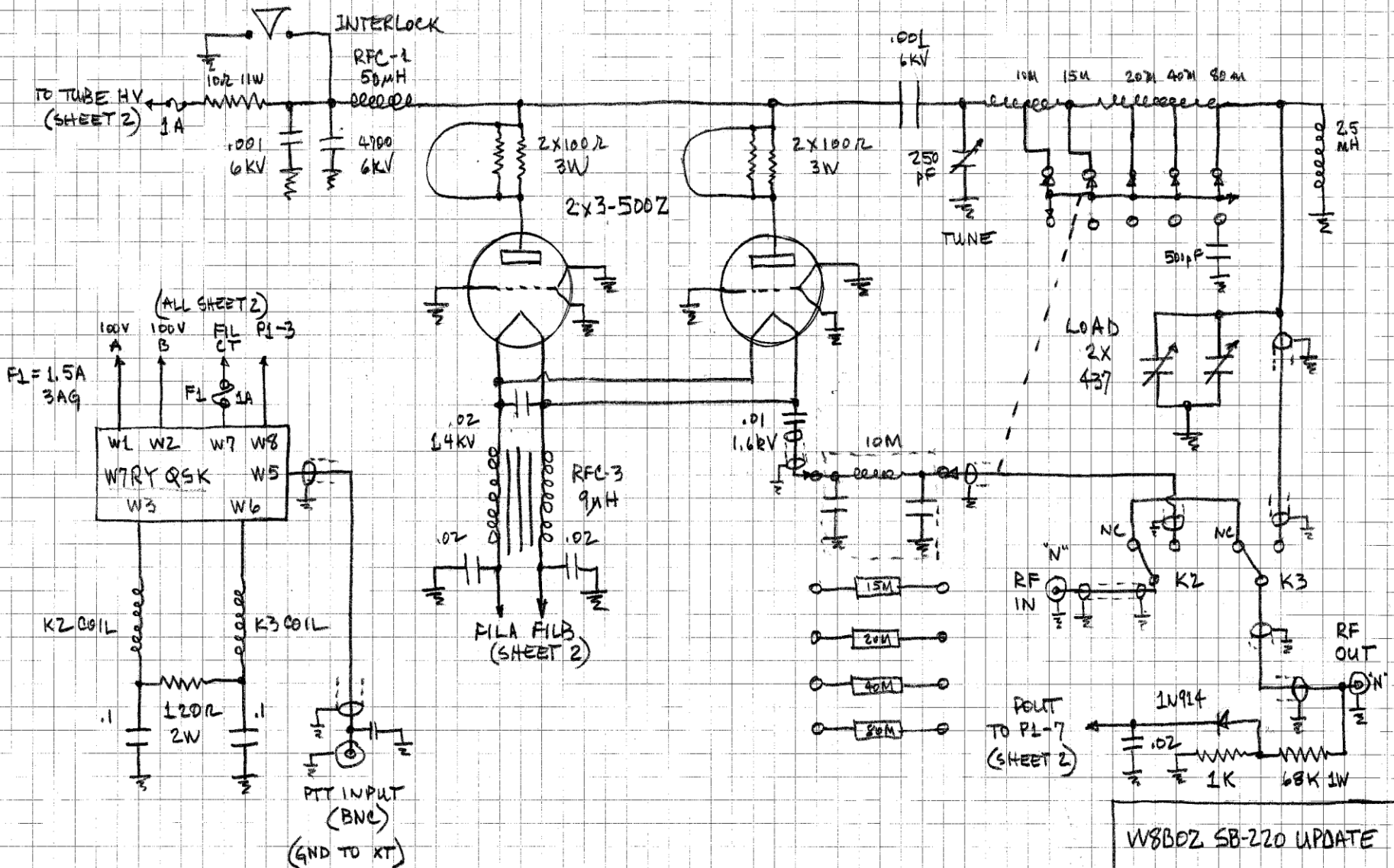

WB80Z SB-220 UPDATE  
 SHEET 1 OF 2  
 BRADREHM 1/13/12  
 WVS

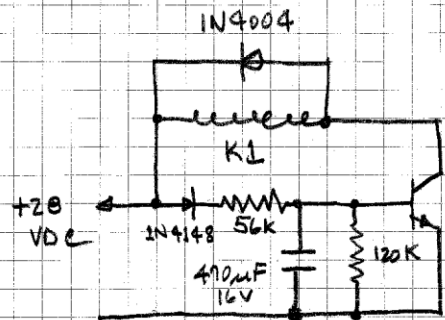

- |              |         |   |
|--------------|---------|---|
| PI-1         | WH      | 1 |
| PI-2         | BLK     | 2 |
| PI-3         | GRN     | 3 |
| FILA         | BLK     | 4 |
| FILB         | BLK/RED | 5 |
| PL-6         | BLU     | 6 |
| POUT (SAT Z) | RED     | 7 |
| GND          | VIOL    | 9 |

PL/J1 NOTE: P1 ALLOWS SEPARATION OF FRONT PANEL FROM CHASSIS.

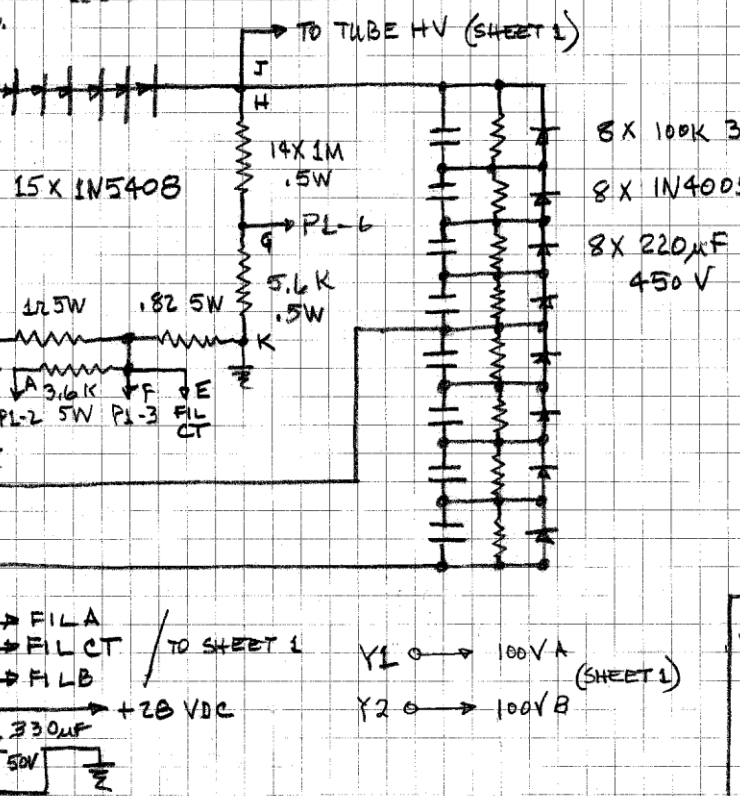
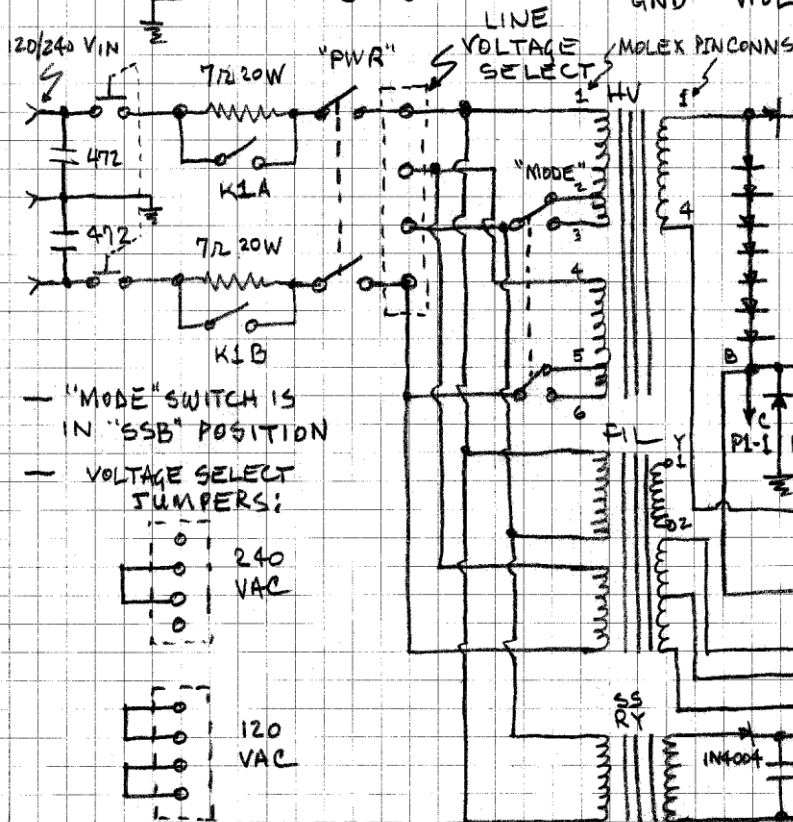
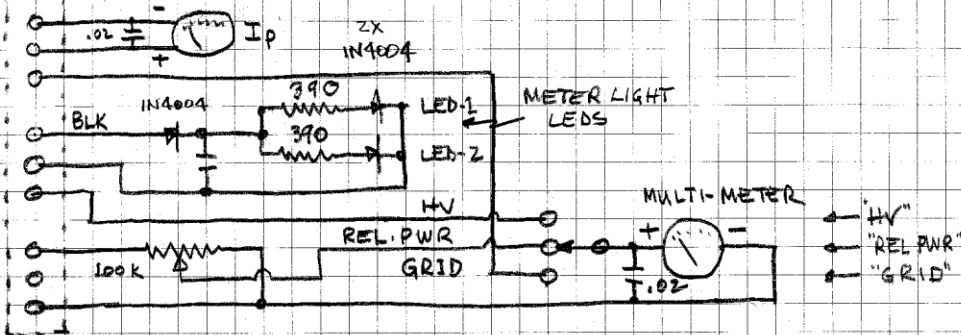

"MODE" SWITCH IS IN "SSB" POSITION

VOLTAGE SELECT JUMPERS:

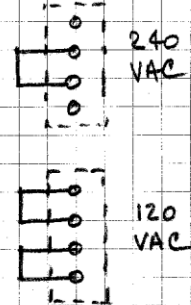

Y1 0 → 100V A (SHEET 1)  
Y2 0 → 100V B

WB80Z SB-220 UPDATE  
SHEET 2 of 2  
BRAD REHM 1/13/12  
KV5V