

JUMA PA1000

Linear Amplifier

User Manual



Congratulations!

Thank you for choosing the JUMA PA1000 linear amplifier.
You will find it easy to use. Enjoy using your new JUMA PA1000.
Please review this entire manual for important information.

Safety Warnings!

Dangerous voltages inside the PA1000.

Do not open the enclosure.

Check that the mains AC voltage to be used is the same as marked on the rear panel.

If you have a switchable 115/230VAC option check that the voltage on the bottom of the case is set correctly.

Use an AC mains supply with a protective earth ground.

If a protective earth ground is not available connect your station ground to the rear panel ground terminal.

If you ever need to change fuses, first switch OFF power with the rear panel rocker switch.
Then remove the power cable and wait 5 minutes before changing fuses.

Introduction

The JUMA PA1000 is a state-of-the-art, ultra lightweight kilowatt amplifier covering 160 through 6 meters in an attractive carry-on size. It uses the latest solid-state technology and is built for portable, travel, DXpedition, as well as home station use. The amplifier has high gain and operates with high efficiency. Maximum exciter drive to the amplifier is 25W. It produces full-rated output of 1000W PEP with low input power, typically around 10W.

The PA1000 is engineered to provide reliable use in normal amateur radio operation as rated using SSB and CW modes. A rugged, industrial-grade LDMOS RF power MOSFET is used. These devices have inherent high SWR tolerance but must be protected from overdrive and excessive input power. The amplifier has built-in fault protection for high SWR, high current and excessive temperature. Fans are quiet and user-adjustable.

An innovative design allows wide ranging use to matched antennas without need for an external tuner. A low-pass RF filter section provides clean output with minimal loss. The built-in power supply is a proven, lightweight "RFI-silent" resonance AC/DC converter and provides user-selectable voltage option. The PA1000 can be used with nearly any transceiver and provides automatic band switching as well as BCD output to control an external device such as a switchable or automatic antenna.

In addition, firmware is readily updated and fully remote operation can be configured. Available options are a switchable 115/230 VAC power supply, 12V out and the JUMA COM HUB.

Copies of the latest User Manual may be downloaded at www.jumaradio.com/juma-pa1000

*Thank you for choosing the JUMA PA1000
and hope you have many enjoyable contacts with this great amplifier!*



JUMA PA1000 is designed in Finland by OH2NLT and OH7SV
JUMA® is a registered trademark of Juha Niinikoski and Matti Hohtola.
All Rights Reserved. Copyright jumaradio.com

Precautions and Warnings!

Normal input power is 10 watts!

NEVER allow exciter drive power to exceed 25 watts to the TRX input connector.

Design precautions ensure the LDMOS RF power MOSFET is not subject to excessive input and overdrive. The PA1000 uses built-in RF input attenuator to limit drive power to nominal levels of about 10W, while still achieving full-rated output power. The amount of input attenuation sets the range of user adjustable gain levels (G1 to G8) on each band. The highest gain levels (above G4) should only be used if it is certain there is no risk of transceiver overdrive.

Some transceivers exhibit initial, brief power spikes, up to 100W or more, even when a low power setting like 10W is selected. This results from the inherent timing of ALC and compression circuits in the transceiver. You will achieve full-rated power output with nominal input power of 10W by selecting a suitable gain setting (G1-G8) in PA1000. In all cases, do not allow exciter drive power to exceed 25 watts.

A reasonably matched resonant antenna is highly recommended- instead of using an antenna tuner!

High power antenna tuners are typically limited to matching loads with a SWR 3:1 or better. High power automatic tuners also generally require at least 15 to 20 watts to achieve an acceptable match. Besides, any poorly matched antenna has inevitable loss even when a tuner is used.

The JUMA PA1000 is designed with excellent output impedance matching and built-in fault protection for high SWR. The amplifier will safely switch to standby with a high SWR. However it is critical to understand that any antenna tuner rated for 1kW or more MAY NOT safely tolerate high power with an unknown SWR and severely mismatched load. In certain cases, the current or voltage limits of tuner components can be exceeded. This may produce arcing or other tuner failure which can present damaging energy to the amplifier.

If you choose to use a tuner do not exceed its power and SWR limits.

If the power ratings with the SWR limits of a tuner are not specified you should not use the tuner.

Any antenna tuner, roller or relay switched inductors/capacitors, and especially auto tuners, **must** be pre-adjusted at the lowest practicable RF power level to avoid applying damaging RF voltage to the amplifier.

TUNE WITH EXCITER LOW POWER AND DISABLE AUTO TUNE FOR JUMA PA1000 USE!

Tuning an antenna tuner with the PA1000 in the OPER state may damage the amplifier and will void the warranty.

IT IS RECOMMENDED NOT TO USE AN ANTENNA TUNER

but to adjust your antenna to a reasonable SWR.

Use an antenna that provides reasonable impedance matching

Reduced power output may occur with a poorly matched antenna. SWR of 1.5:1 or better is recommended. If SWR reaches 2:1 or worse you may need to lower the amplifier gain and/or reduce drive level. Do not use any antenna with an unknown SWR.

AUTO BAND tracking is highly recommended

Use the cable connection for band data that is applicable for your transceiver. Manual band selection is NOT recommended – accidental manual wrong band selection may cause amplifier failure.

Avoid full-duty cycle key-down operation

The amplifier is designed for SSB and CW operation and not for 100% duty cycle key-down operation such as AM, FM. The amplifier may enter STBY mode for temperature protection during prolonged key-down periods. JUMA PA1000 can be used in digital modes e.g. FT8, FT4, RTTY and others when the transmit time is limited to 15 seconds or less. To improve efficiency during digital modes and on all modes in heavy use, the PA voltage can be adjusted to the LOW PA voltage setting while reducing the output power below 700W. Follow the temperature indication to find a suitable power level. Temperature protection threshold is 110°C.



JUMA PA1000 overview

JUMA PA1000 is an ultra lightweight (just 5.5kg / 12 lb) solid state 1kW linear amplifier for HF and 6 meter bands. It is especially convenient for DXpeditions and for travel as well as for home station use.

The JUMA PA1000 uses a modern LDMOS transistor in the RF amplifier. RF output matching is based on an innovative design which provides excellent efficiency. The power supply is a RF-silent lightweight high efficiency resonance design. The PA1000 is completely silent after cool down and it can be left standby indefinitely, consuming only 5 watts which is very convenient for remote use.

JUMA PA1000 accepts band data from popular transceivers. It supports parallel BCD, serial band data and analog band voltage.

JUMA PA1000 is fully protected against excessive SWR, over current and over temperature. It withstands wrong band antennas, open or short circuit in the RF output and accidental impedance transients. The SWR protection is based on reverse RF power coming back from the antenna. Thus if your antenna SWR is too high you can continue working by lowering the output power.

Simple user interface

JUMA PA1000 is easy to use. There are only necessary push buttons in the front panel. LCD indicates the essential information, LED bar shows the output power and reverse power. OPER, AUTO band and protection are indicated by their own LEDs. The rear panel has the fused AC power connector, TRX connector, ANT connector, PTT input and BAND DATA/COM inputs. Firmware update is easy with connection to a PC.

Features

- Nominal output power 1000W PEP – SSB and CW
- All HF bands including WARC bands and 50 MHz
- Nominal 10W input power
- Adjustable input attenuator (Gx setting) for 5W to 20W exciter drive
- Input matching better than 1.2 : 1 on all bands
- LCD display for band, gain, SWR, voltage, current and temperature
- LED bar display for forward and reverse RF power
- SWR, over current and over temperature protection
- Temperature-controlled proportional speed fan
- Auto band data or manual band selection
- Band data formats: BCD, RS232, C-IV and voltage
- Converts serial, voltage or manual band data input to BCD band data output. Convenient feature for antenna switching and other applications.
- Quiet and rapid T/R relay for break-in CW operation
- Remote support with a free Windows application. See more here www.jumaradio.com/juma-pa1000
- Firmware updates with any PC
- 230VAC and selectable 115/230VAC with an option
- Low mains current consumption, less than 7A @ 230VAC and less than 14A @ 115VAC
- Small size: 260 x 135 x 300 mm (W x H x D) 10.2 x 5.3 x 11.8 in
- Ultra lightweight: 5.5kg / 12 lb
- CE marked
- Two year warranty and One year MOSFET warranty.

JUMA PA1000 front panel

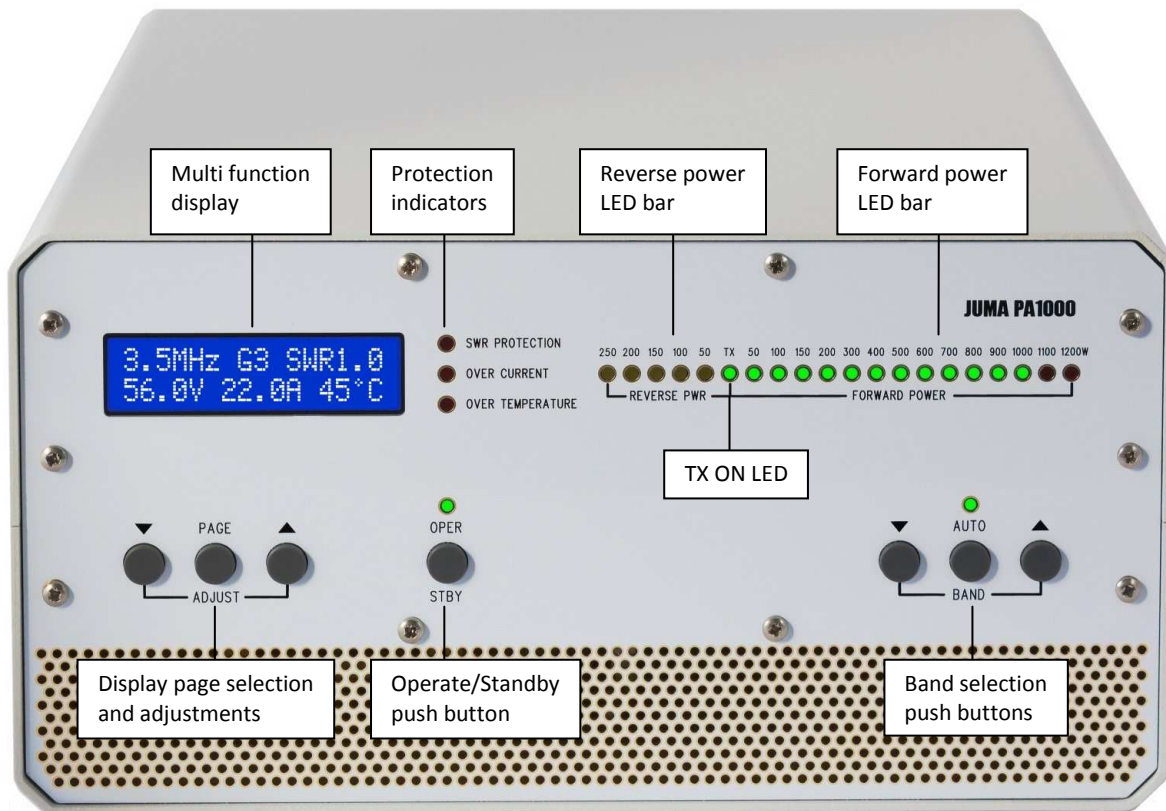

JUMA PA1000 rear panel

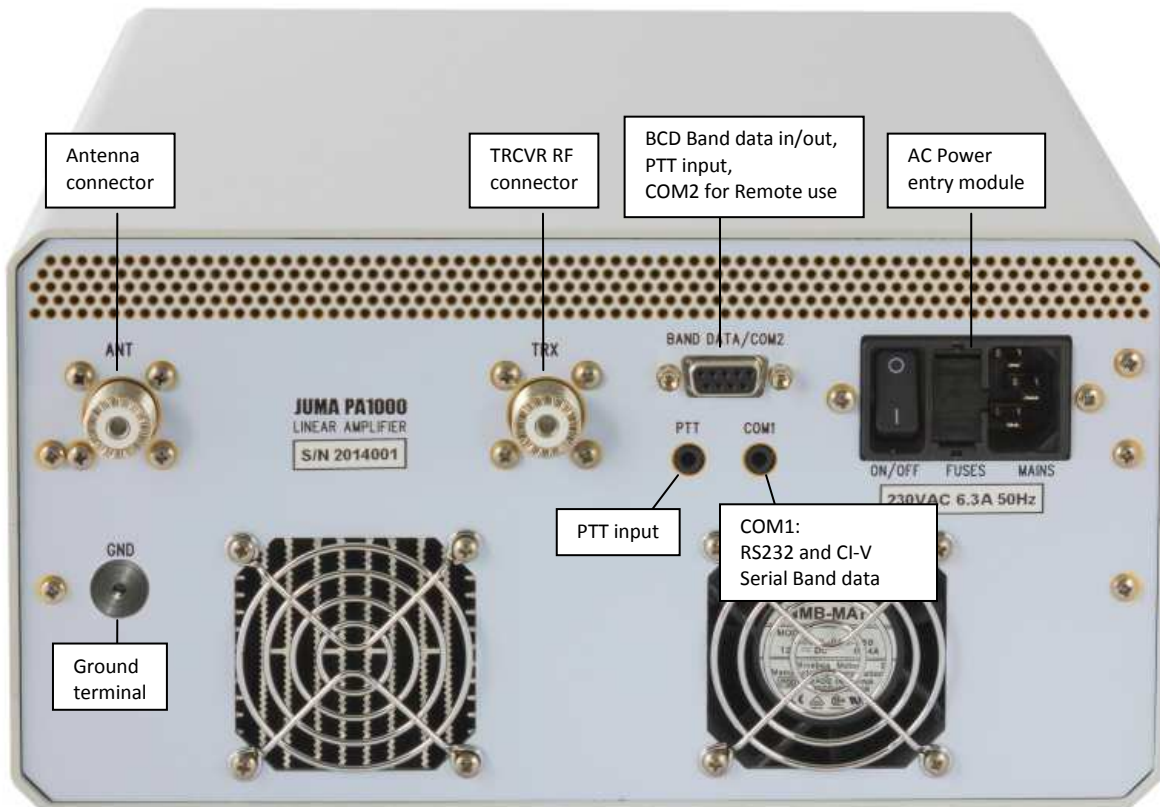

Display page selection and adjustments



PAGE button selects display page one after another. ADJUST buttons changes the setting on each page.

Main Page

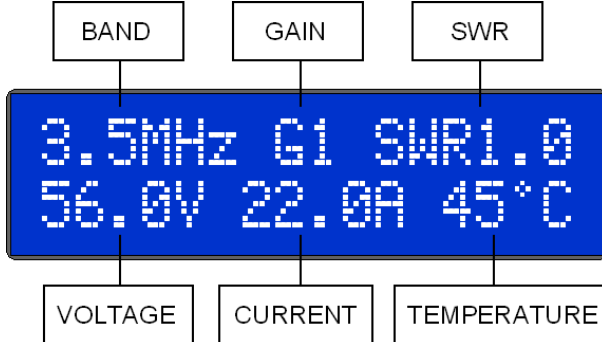

In the Main Page the ADJUST buttons are changing the gain of the amplifier by means of the adjustable input attenuator. The gain can be set from G1 to G8 with a step of 1dB. Always start with G1 which is the lowest gain by monitoring the power LED bar. PA1000 will remember the gain on each band.

Nominal PA voltage is 56V \pm 2V or reduced 50V \pm 2V. Nominal zero drive bias (idle) current is 2.0A \pm 0.3A. Typical peak current for full power is abt 24A.

The temperature reading is indicating the MOSFET case temperature. The temperature rise of the heatsink is about half of the case temperature rise. Max MOSFET case temperature is 110°C.

Other display pages

Push the PAGE button one after another for the other display pages and use the ADJUST buttons to change the setting.



LCD brightness adjustment



LCD contrast adjustment



Auto band data selection. Options: BCD data, JUMA Serial, Icom CI-V, Kenwood Serial, Elecraft Serial, Yaesu Voltage, Icom Voltage. See the control cable instructions down the user manual.



COM1 baud rate adjustment for serial band data. Select the same baud rate in your transceiver if you are using serial (RS-232 or CI-V) band data.



COM2 baud rate adjustment for remote control with the Windows remote application.



Fan control adjustment. The fan will run with the maximum RPM at the selected temperature. Normally you can select 90°C-100°C. In heavy use you may consider to lower this setting for proactive cooling but then the fan is more noisy. The fan will be fully off when the temperature has cooled down to 30°C.



PA voltage adjustment. The purpose of this adjustment is to optimize the efficiency. The options are High (56V) and Low (50V). Select Low PA voltage for all reduced power operations below 700W and especially with sufficiently reduced power in digi modes.

LED Bar Power Indicator



The LED bar RF power indicator gives a real time view of forward and reverse power. It is indicating the peak power. The LED bar hold time and the decay speed can be adjusted in the Service Page if desired.

Protection indicators

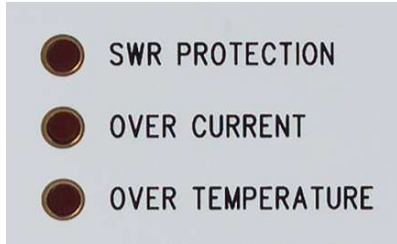

The protection is implemented in the hardware and therefore it is independent of the software latency and operation. When a protection event is detected JUMA PA1000 will switch to standby until cleared.

SWR PROTECTION LED will be lit if the reverse power limit is exceeded. In this case check antenna, reduce PA1000 gain or reduce exciter drive.

OVER CURRENT LED will trip if the MOSFET current 30A is exceeded. In this case reduce the gain (Gx) or reduce the drive. You can monitor the current in the LCD.

OVER TEMPERATURE LED will be lit if the MOSFET case temperature 110°C is exceeded. In this case reduce power. Over temperature led will go off when the temperature has fallen below the threshold level. However amplifier will stay in STBY state until you clear it by pushing OPER button.

OVERLOAD PROTECTION in LCD is an additional SW protection. This protection will trip if the output power is less than 150W when PA current is exceeding 12A.

After you have checked the protection situation clear it by pushing the OPER button.

OPER / STBY button



Simply push OPER/STBY button to switch between operate and standby state. OPER LED will be ON in operate-state.

Note1. The default state is STBY during power-up and band change. This can be modified in the Service Pages so that PA1000 will remember OPER/STBY state for start-up and band change. See the details in Service Pages documentation.

Note2. You can transmit 100W thru PA1000 in STBY state and when PA1000 is switched OFF but **remember to reduce the drive power** before switchig PA1000 to OPER state!

Band selection buttons



Push AUTO button for automatic band selection. Green LED will be ON and the main display is showing the band. If valid band data is not available the main display is showing “?? MHz” and PA1000 will not operate. In this case check band data cable, band data setting and the baud rate setting of the COM1.

Manual band selection is made by first pushing the BAND button which after you can select the band by pushing ▼ and ▲ buttons.

In manual band selection there is a special “AllMHz” band which indicates that the final low-pass filters are bypassed. Do not transmit with “AllMHz” selection without external low-pass filter because the harmonics are not filtered.

JUMA PA1000 saves the band selection mode for the next power-up.

Note. Manual band selection is not recommended because you may inadvertently select wrong band which may damage the amplifier.

Quick Start for first time use

Auto band selection.

RECOMMENDED!

1. Connect antenna with coaxial cable.
2. Connect transceiver with coaxial cable.
3. Connect PTT and band data cable from transceiver. You may need one or two cables depending on your transceiver. See the cable instructions. In the case of JUMA TRX2 PTT cable is not needed.
4. Adjust transceiver RF power output level to 10W.
5. Connect AC mains cable and switch on JUMA PA1000 by the rear panel switch.
6. After start-up go to the Band Data page by pushing PAGE button several times. Use ADJUST buttons to select a compatible band data format. In case of a serial band data check also the COM1 baud rate that it matches with your transceiver setting.
7. Push PAGE button several times until you are back in the Main Page (Band display left up).
8. Push AUTO BAND button. LED indicates auto band and you should see the band in the main display page. Check that PA1000 is tracking the transceiver band.
9. Push OPER button. LED indicates operate state.
10. Transmit SSB or CW with your transceiver and watch the output power LED bar. Do not use AM or FM for gain setting.
11. Adjust PA1000 gain with ADJUST buttons in the main page (G1, G2, G3...) for desired power level on each band.

Next time use

Simply switch on PA1000 and push OPER button. JUMA PA1000 will memorize all other settings.

Warnings!

- **Set the exciter power to 10W on ALL modes and on ALL bands in your transceiver. Never exceed 25W exciter drive power.**
- **Use AUTO band data with an appropriate cable and setting for your transceiver.**
- **Adjust gain (Gx) on SSB or CW modes to desired output power. Do not use Carrier, AM, FM modes because they may produce damaging high power transients.**
- **Antenna tuner is not recommended. If any tuner is used, tune with exciter low power and disable auto tune function for high power.**

Quick Start for first time use

Manual band selection.

NOT RECOMMENDED!

1. Connect antenna with coaxial cable
2. Connect transceiver with coaxial cable
3. Connect PTT cable from transceiver. See cable instructions. In the case of JUMA TRX2 PTT cable is not needed.
4. Adjust transceiver RF power output level to 10W.
5. Connect AC mains cable and switch on JUMA PA1000 by the rear panel switch
6. Select manually correct band with BAND ▼ ▲ buttons. Main display shows the band.
7. Push OPER button (LED indicates operate state)
8. Transmit SSB or CW with your transceiver and watch the output power LED bar. Do not use AM or FM for gain setting.
9. Adjust PA1000 gain with ADJUST buttons in the main page (G1, G2, G3...) for desired power level on each band.

Next time use

Switch on PA1000, check the band and push OPER button. JUMA PA1000 will memorize all other settings.

Note. Manual band selection is not recommended because you may select wrong band sooner or later. Then you may end up to accidentally increase the drive and it may damage the amplifier.

Rear Panel Connectors

BAND DATA / COM2 Connector

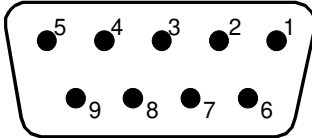

D9 female socket

BAND DATA / COM2 Connector Description

Pin #	Description
1	BCD A (Band data) *
2	COM2 RS232 OUT (Serial com output) **
3	COM2 RS232 IN (Serial com input)**
4	BCD D (Band data) *
5	GND (Signal ground)
6	BCD B (Band data) *
7	PTT IN (Parallel with PTT jack connector tip)
8	BCD C (Band data) *
9	BAND VOLTAGE (Input)

*Band data signals are pulled up to +5V with 100k resistors.

**COM2 is used for firmware updates and remote connection

BCD Band Data Table

Band	Freq	BCD D	BCD C	BCD B	BCD A
160 m	1.8 MHz	0	0	0	1
80 m	3.5 MHz	0	0	1	0
40 m	7.0 MHz	0	0	1	1
30 m	10 MHz	0	1	0	0
20 m	14 MHz	0	1	0	1
17 m	18 MHz	0	1	1	0
15 m	21 MHz	0	1	1	1
12 m	24 MHz	1	0	0	0
10 m	28 MHz	1	0	0	1
6 m	50 MHz	1	0	1	0
All band	"AllMHz"	0	0	0	0

BCD code 0000 as an input bypasses the low-pass filters and the display indicates "AllMHz".

All other input codes (1011 ... 1111) are not valid and they are indicated as "?? MHz". In that case PA1000 will not transmit.

Tip: JUMA PA1000 converts serial, voltage or manual band data to BCD output on the four BCD lines in D9 connector. This BCD output can be used to control antennas or other equipment. The output is 0V/+5V with an output impedance of 1kΩ. Thus the BCD output signals must be buffered e.g. with a BCD to Decimal decoder IC. If band data is not available PA1000 will output BCD code 1111. If "AllMHz" is manually selected PA1000 will send BCD code 0000.

PTT in 3.5 mm jack

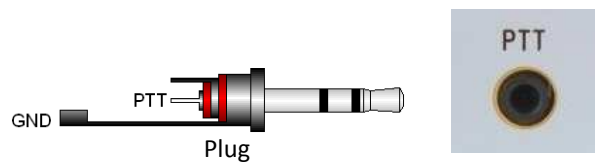

Tip is the PTT in signal and it should be grounded for transmit. PTT signal is in parallel with D9 connector pin7. PTT signal is internally pulled up to +5 V with a 4.7 kilo-ohm resistor. Current sinking requirement is 1 mA. *The ring terminal is not connected inside PA1000 so you can also use a MONO plug for PTT connector.*

In case of JUMA TRX2 transceiver the PTT cable is not needed. PTT signal is fed via the input coaxial cable.

COM1 3.5 mm jack

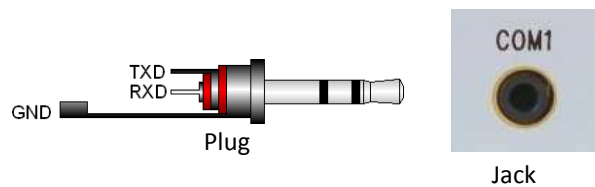

This connector is a multi-use serial com for RS232, CI-V. Tip is RXD and ring is TXD. In CI-V tip and ring must be connected together in the PA1000 end of the cable.

Note1. Do NOT connect RS232 serial outputs together.

Note2. RS232 serial output can be connected to several RS232 data inputs.

Note3. Icom CI-V open drain signals can be connected in parallel with other CI-V signals like logging software.

AC Power Entry Module



This is an example picture of the mains input. The mains power switch, 2 x fuse and mains cable socket. See the actual fuse values in the rear panel of your JUMA PA1000. If you need to replace the fuses, they are located in the removable snap-in cassette in the middle. The size of the fuses are 5mm x 20mm.

Cable instructions for transceivers

JUMA TRX2 cable (RS232 band data)

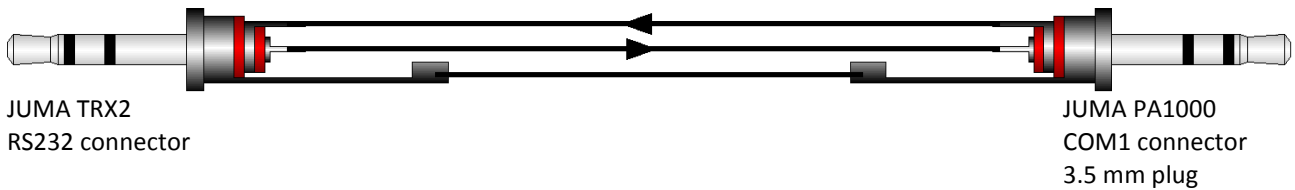

Note1. Both ends 3.5 mm stereo plugs. A standard stereo audio cable can be used.
Note2. PTT cable is not needed. PTT signal is superimposed on RF in the coaxial cable.

ICOM CI-V cable (Band data)

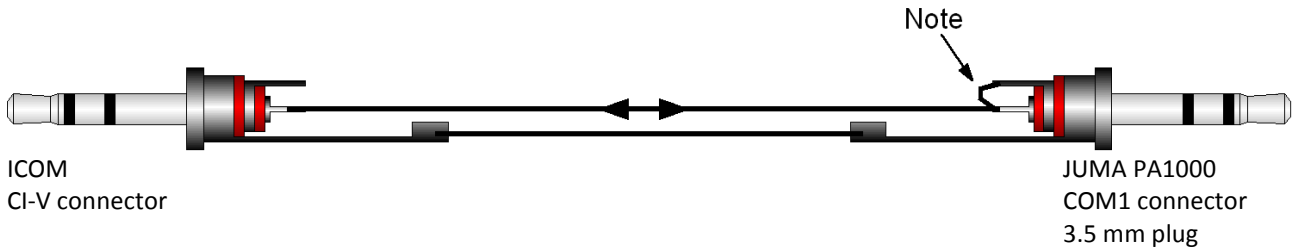

Note1. Both ends 3.5 mm plug. A mono plug can also be used in Icom end.
Note2. A standard 3.5 mm stereo audio cable can NOT be used. PA1000 end of that must be modified as shown.

ICOM PTT cable

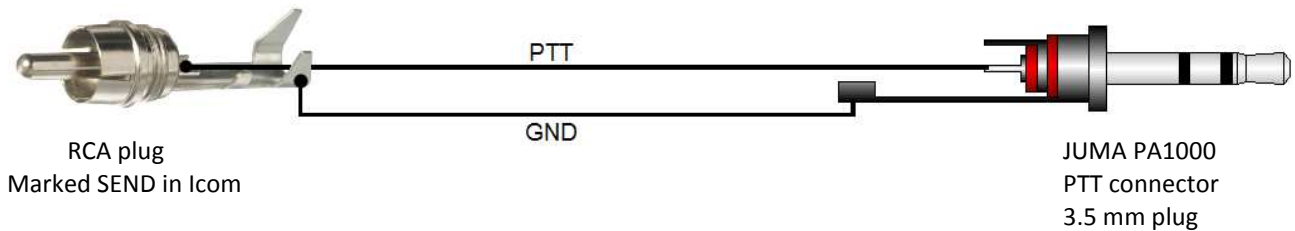

Note1. A mono plug can also be used in JUMA PA1000 because the ring is not connected inside JUMA PA1000.
Note2. In some Icom radios like IC-7100 there is no RCA SEND connector. In that case use ACC connector pin 2 for GND and pin 3 for PTT (HSEND or SEND). See your Icom user manual.

Elecraft KX3 cables

KX3 RS232 band data cable

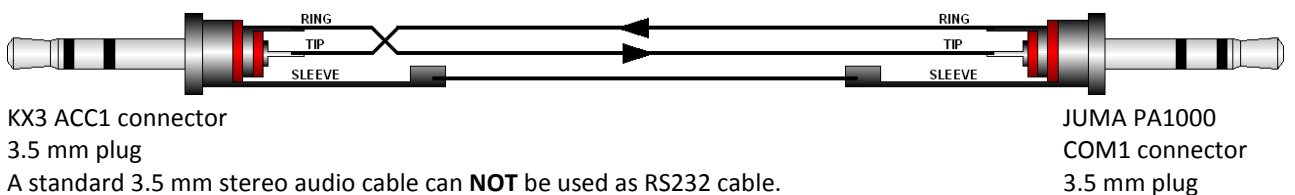

A standard 3.5 mm stereo audio cable can **NOT** be used as RS232 cable.

Note1. In KX3 menu set AUTOINF to ANT CTRL
Note2. Select Elecraft Serial band data in PA1000

KX3 PTT cable

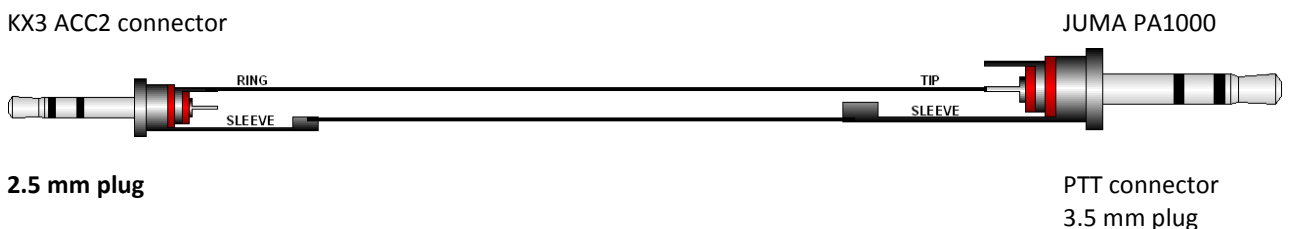

See appendix 1. for PX3 Panadapter combination

Cable instructions for transceivers cont.

Elecraft K3, K3S BCD Band Data & PTT



Elecraft K3 ACC connector



JUMA PA1000 BAND DATA connector

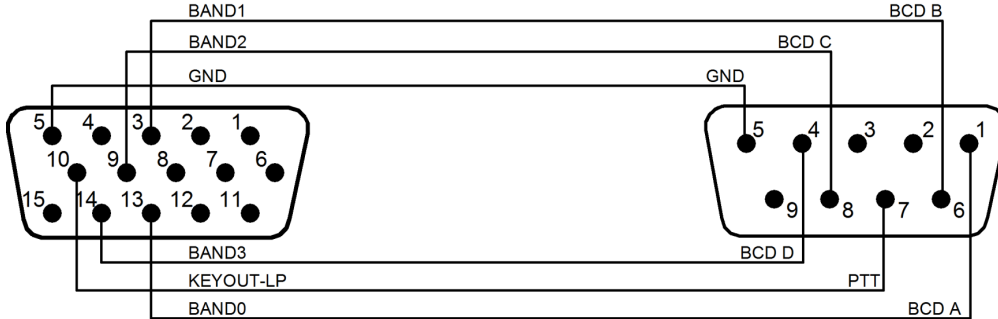

D15 male plug seen from solder side

DB9 male plug seen from solder side

Note1. A 15 pin VGA cable can NOT be modified for a K3 cable because some pins are connected together inside the molded VGA plug. Make a new cable with a 15 pin and a 9 pin male D-connector plugs.

Note2. Select BCD BAND DATA in JUMA PA1000

Yaesu FT-1000 BCD Band Data & PTT



Yaesu FT-1000MP BAND DATA connector



JUMA PA1000 BAND DATA connector

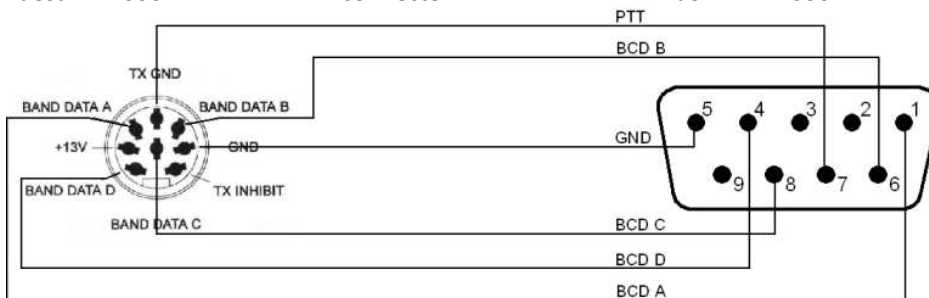

8 pin DIN male plug in cable

D9 male plug seen from solder side

Note. Select BCD BAND DATA in JUMA PA1000

Yaesu FT-891 BCD Band Data & PTT



Yaesu FT-891 TUN/LIN connector



JUMA PA1000 BAND DATA connector

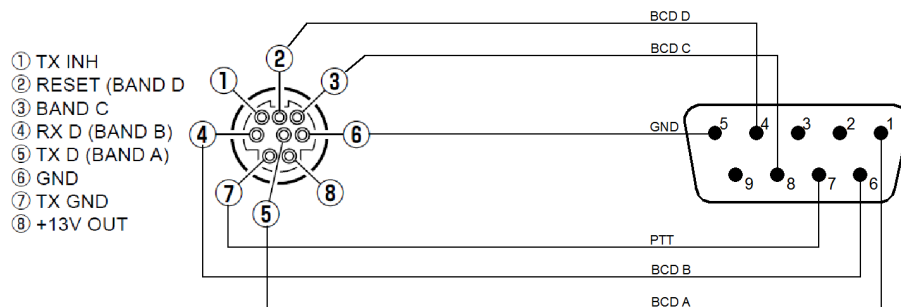

Note1. Set the FT-891 menu item 16-15 to "LAMP" (Linear Amplifier)

Note2. Select BCD BAND DATA in JUMA PA1000

Cable instructions for transceivers cont.

Yaesu FTDX101 and FTDX3000 BCD Band Data & PTT

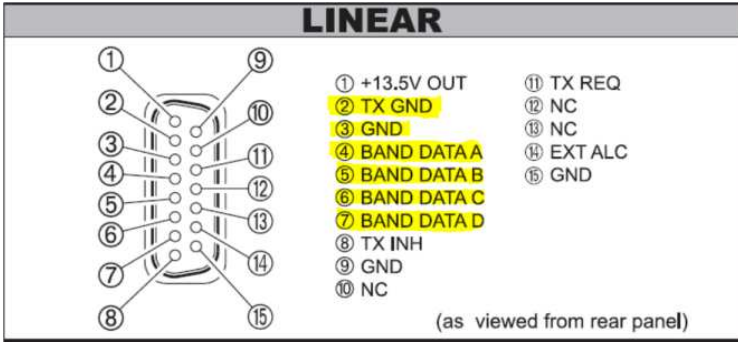

Yaesu FTDX3000 and FTDX101 LINEAR connector



Pin #	Description
1	BCD A (Band data A)
4	BCD D (Band data D)
5	GND (Signal ground)
6	BCD B (Band data B)
7	PTT IN (TX GND)
8	BCD C (Band data C)

JUMA PA1000 BAND DATA connector pins

SunSDR2 PRO BCD Band Data & PTT



SunSDR2 PRO EXT CTRL connector



JUMA PA1000 BAND DATA connector

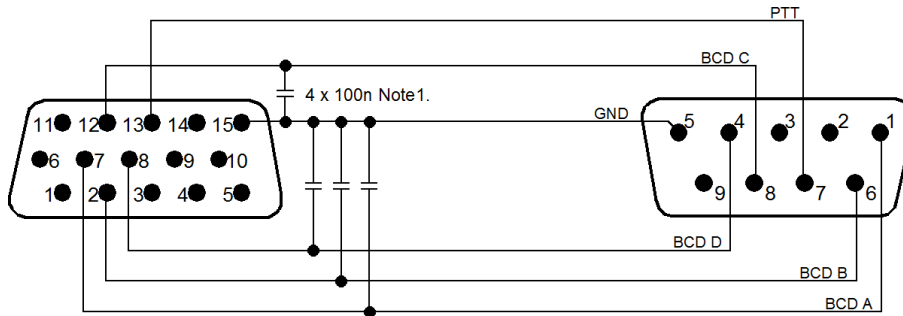

DB15 male plug seen from solder side

DB9 male plug seen from solder side

- Note1. Solder 4 x 100nF capacitors inside the DB15 plug to avoid RF interference to the band tracking.
- Note2. A 15 pin VGA cable can NOT be modified for a SunSDR2 cable because some pins are connected together inside the molded VGA plug. Make a new cable with a 15 pin and a 9 pin male D-connector plugs.
- Note3. Select BCD BAND DATA in JUMA PA1000
- Note4. Make the following configuration to SunSDR2 PRO in Ext Ctrl tab.

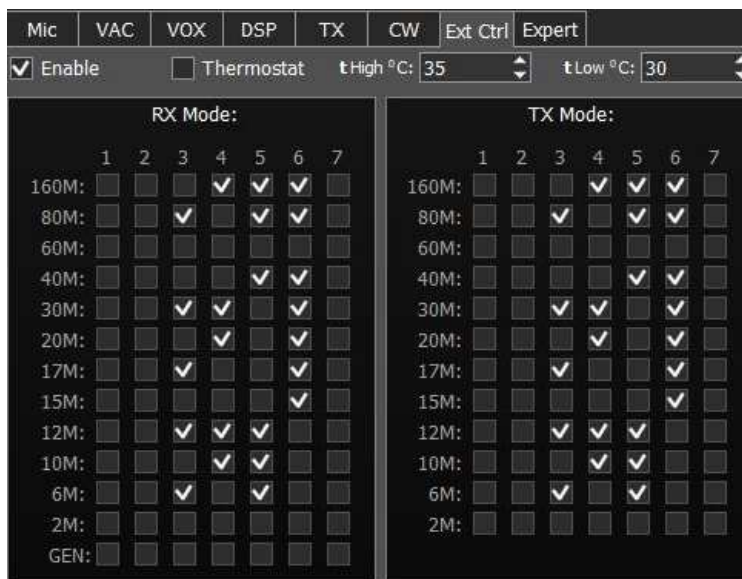

SunSDR2 PRO Ext Ctrl tab

Cable instructions for transceivers cont.

FlexRadio 6000 series Band Data cable and PTT cable

BCD Band Data Cable

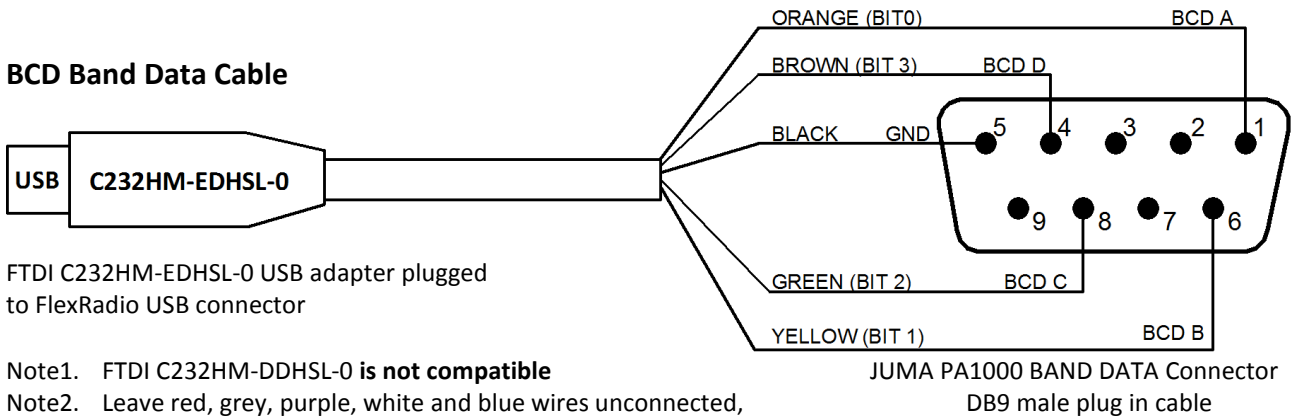

PTT Cable

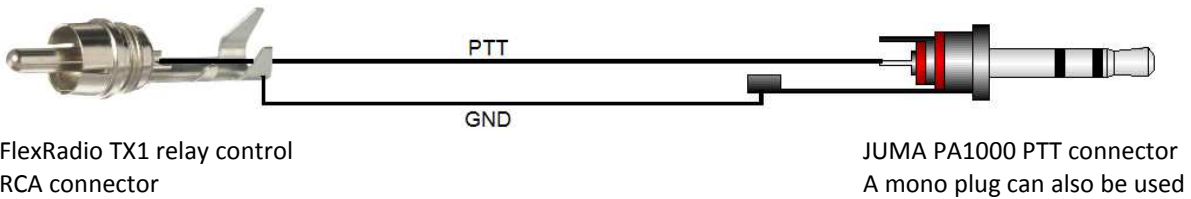

Setting Notes

- Note1. In JUMA PA1000 BAND DATA page select BCD data
- Note2. In Flexradio USB Cables menu select Cable Type BCD, TX Slice, HF_BCD, Active High
- Note3. In Flexradio set TX1 relay control for HF transmit

Wire	Signal
Red	VCC
Orange	BIT/PIN 0
Yellow	BIT/PIN 1
Green	BIT/PIN 2
Brown	BIT/PIN 3
Grey	BIT/PIN 4
Purple	BIT/PIN 5
White	BIT/PIN 6
Blue	BIT/PIN 7
Black	GND

C232HM USB adapter wires

Band	BCD Output			
	Bit 3	Bit 2	Bit 1	Bit 0
160	0	0	0	1
80	0	0	1	0
60	0	0	0	0
40	0	0	1	1
30	0	1	0	0
20	0	1	0	1
17	0	1	1	0
15	0	1	1	1
12	1	0	0	0
10	1	0	0	1
6	1	0	1	0

Flexradio HF_BCD band table

Cable instructions for transceivers cont.

Elecraft K2 and K3 RS232 serial COM cable

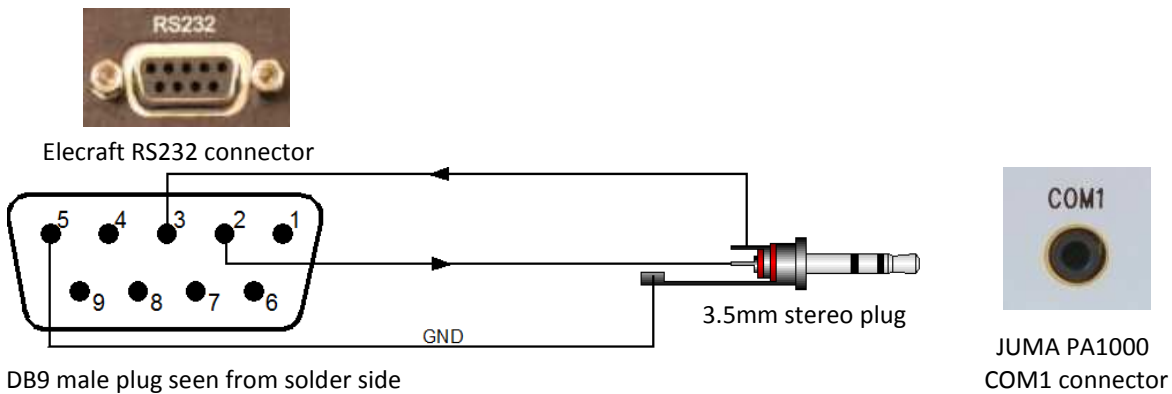

Note1. **With K3/K3S we recommended BCD band data and leave the COM for PC applications. See previous pages.**

Note2. Select Elecraft Serial in PA1000

Note3. Set K3 to Auto-info mode 1

Note4. K3S is using a RJ45 connector for RS232. Check the wiring in K3S user manual.

Note5. K2 needs KIO2 option for RS-232 and KEY OUT modification

Kenwood RS232 serial COM cable

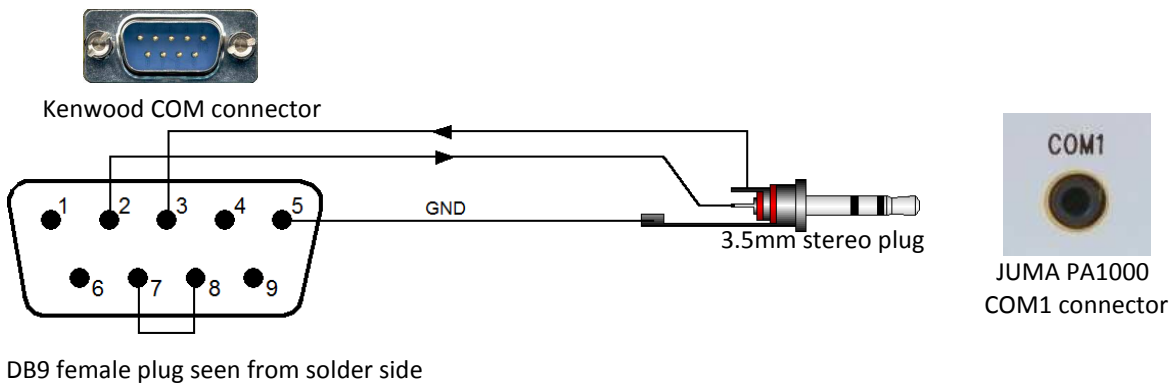

Note. JUMA PA1000 is supporting Kenwood RS232 serial band data similar to TS480 and TS2000 protocols. Select one which is compatible with your Kenwood transceiver. Kenwood is not sending band data event when the band is changed, it is polled by JUMA PA1000. To speed up the band change set PA1000 Radio Poll Rate to 500ms in the Service pages. Note also that some Kenwood transceivers need to be restarted to activate a new baud rate setting.

Additionally a PTT cable is needed. Use Kenwood REMOTE connector Pin 4 for PTT and Pin 2 for GND.

Check also Kenwood menu settings to activate linear amplifier control.

Kenwood PTT cable with 7-pin DIN connector

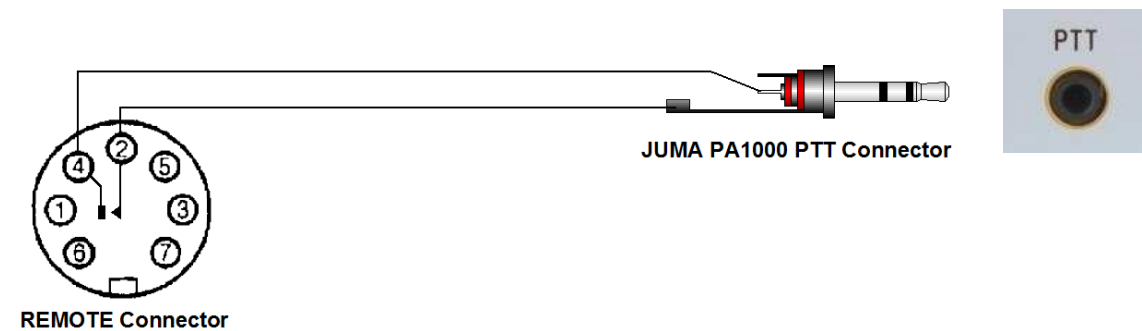

Cable instructions for transceivers cont.

Kenwood PTT cable with 8-pin MINI DIN connector

REMOTE CONNECTOR

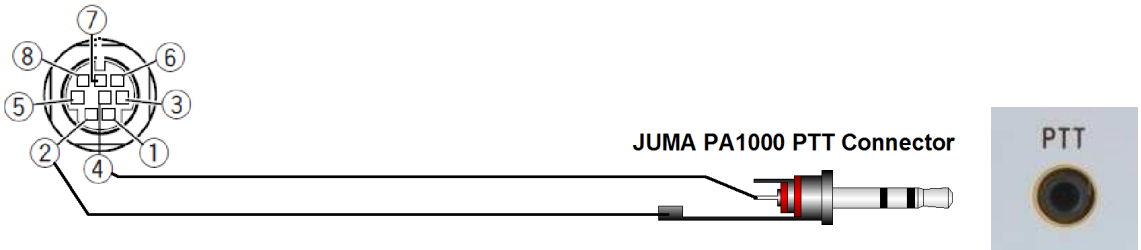

Kenwood TTL level (0V/5V) serial COM cable for TS-440, TS-450, TS-690, TS-850, TS-950 etc.

Use 6 pin DIN plug
ACC1 Connector

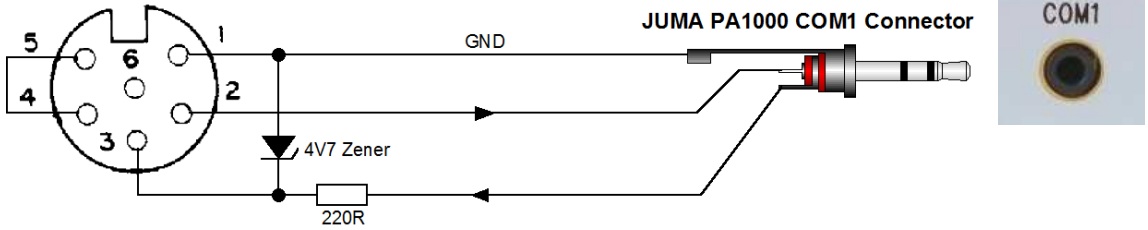

- Note1. Solder the 4.7V zener diode and the 220 ohm resistor inside the 6 pin DIN connector.
- Note2. In JUMA PA1000 **set BAND DATA to Elecraft Serial** and set the equal baud rate for both.
- Note3. Kenwood is not sending band data event, it is polled by JUMA PA1000. To speed up the band change set JUMA PA1000 Radio Poll Rate to 500ms in the Service pages.

YAESU band voltage (0...5V)

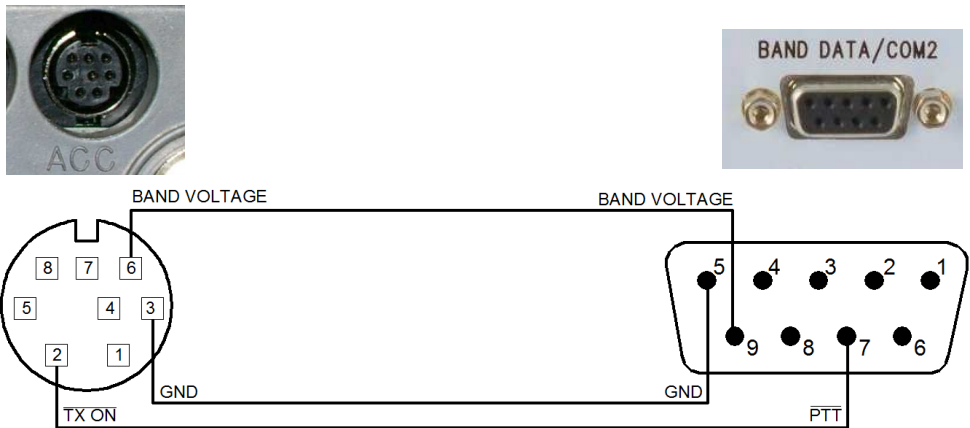

YAESU ACC connector
(FT-817 connector shown)

JUMA PA1000 BAND DATA/COM2
D9 male in cable

Yaesu Band Voltage Table

Band	Freq	Nominal voltage
160 m	1.8 MHz	0.33 V
80 m	3.5 MHz	0.67 V
40 m	7.0 MHz	1.00 V
30 m	10 MHz	1.33 V
20 m	14 MHz	1.67 V
17 m	18 MHz	2.00 V
15 m	21 MHz	2.33 V
12 m	24 MHz	2.67 V
10 m	28 MHz	3.00 V
6 m	50 MHz	3.33 V

Cable instructions for transceivers cont.

ICOM analog band voltage (0...8V)

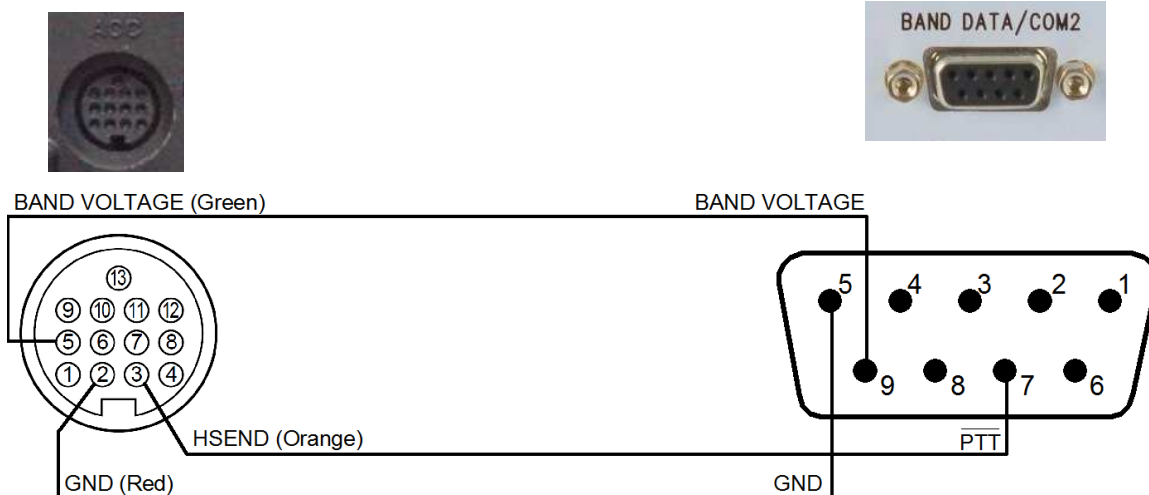

ICOM ACC connector
(IC-7000 connector shown)
See your Icom manual for correct
connector and pin order.

JUMA PA1000 BAND DATA/COM2
D9 male in cable

Note1. Icom band voltage is not supporting 50 MHz and WARC bands but 10 MHz is defined as 0 V. Zero voltage is not a proper level to verify valid band data and thus JUMA PA1000 needs 0.1 V to 1.0 V for 10 MHz selection. 50 MHz is unofficially selected at voltage 1.0 V to 2.0 V.

Note2. Some Icom transceivers need a modification to activate band voltage output. See your Icom manual.

Note3. It is recommended to use Icom CI-V serial band data instead of Icom band voltage if available.

Icom Band Voltage Table

Band	Freq	Voltage range
160 m	1.8 MHz	7.0 V - 8.0 V
80 m	3.5 MHz	6.0 V - 6.5 V
40 m	7.0 MHz	5.0 V - 5.5 V
30 m	10 MHz	0.1 V - 1.2 V
20 m	14 MHz	4.0 V - 4.5 V
15 m/(17 m)	21 MHz	3.0 V - 3.5 V
10 m/(12 m)	28 MHz	2.0 V - 2.5 V
6 m	50 MHz	1.0 V - 2.0 V

Service Pages

Service Pages are intended for advanced use, calibration and special settings. If you are not familiar with the service settings do not change anything and exit Service Pages by switching OFF the JUMA PA1000.



To enter Service Pages keep the PAGE button pressed about 5 seconds until you see text “Service pages selected”.

To exit Service Pages keep the PAGE button pressed again about 5 seconds until you see text “Main pages selected”.

Push the PAGE button one after another for each service page and use the ADJUST buttons ▼ ▲ to change the setting.

Radio Poll Rate (Default = 1000 ms, 0=No poll)

Defines the serial band data polling rate

CI-V Radio Address (Default = 00H)

Defines Icom CI-V address. See your Icom manual

COM 2 Mode (Default = Remote)

Defines COM 2 for PA1000 Remote or Service mode

Beep len, 0=OFF (Default = 50 ms)

Defines audible key beeb length. Value 0 = Sound OFF

Voltage Cal mult (Default = 10619)

Calibrates voltage reading in LCD

Current Cal mult (Default = 8000)

Calibrates current reading in LCD

Pwr Cal mult <30 MHz (Default = 1.00)

Calibrates LED bar power reading below 30 MHz

Pwr Cal mult 50 MHz (Default = 1.25)

Calibrates LED bar power reading at 50 MHz

Power FWD REV SWR (read only)

Forward, reverse and SWR reading for R&D use only

Note1.

The service settings are saved when you exit the Service Pages with a long PAGE button push.

Note2.

If you have accidentally changed calibration values in Service Pages you can restore factory calibration values in the “Factory cal” page.

LED Bar Hold (Default = 100 ms)

Defines the hold time for the LED bar indicator

LED Bar Decay (Default = 200W/100ms)

Defines the decay speed of the LED bar indicator

Keep OPER state (Default = No)

By default JUMA PA1000 will

1. Start-up in STBY state
2. Go to STBY when band is changing

Do not change this item unless you have implemented automatic antenna switching and all your antennas are pre-tuned for each band!

BCD band bits in/out (read only)

Shows BCD band data input or BCD band data output

COM1 RX/COM2 RX (read only)

Shows received amount of bytes. R&D use only

Factory cal, Set=9 Count=0

Restores factory calibration values

Needs 9 keystrokes to avoid accidental restore

Factory defaults, Set=9 Count=0

Restores factory defaults

Needs 9 keystrokes to avoid accidental restore

Do not restore factory defaults, it is intended for factory use only.

Firmware programming

JUMA PA1000 firmware is easy to update. The latest firmware is available on the JUMA website www.jumaradio.com. It is a HEX file with a version identification number (e.g. JUMA_PA1000_v102.hex). You can check your current firmware version in your JUMA PA1000 LCD display during start-up.

All you need is the bootloader client for Windows and a RS232 programming cable. The cable is connected to a RS232 port of your PC or via a RS232-USB adapter. FTDI model of RS232-USB adapter is recommended. See the programming cable drawing.

Quick start for firmware programming

1. Download the latest HEX file to your hard disk
2. Connect the programming RS232 cable
3. Run the Windows bootloader client (Ingenia dsPIC Bootloader)
4. Check bootloader client COM configuration and click "configuration done"
5. Start-up JUMA PA1000 while keeping the PAGE button pushed
6. Open the downloaded HEX file into the bootloader client
7. Click the "start write" button
8. When you see "write completed" restart JUMA PA1000

The bootloader client and the latest firmware HEX file can be found here www.jumaradio.com/juma-pa1000

Firmware programming cable drawing

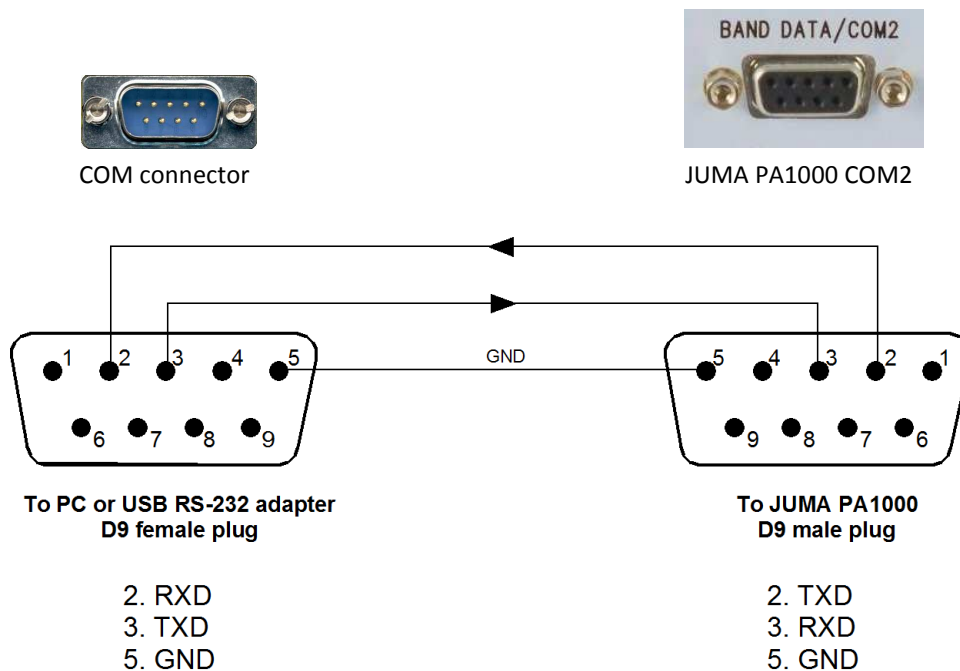

JUMA PA1000 Block Diagram

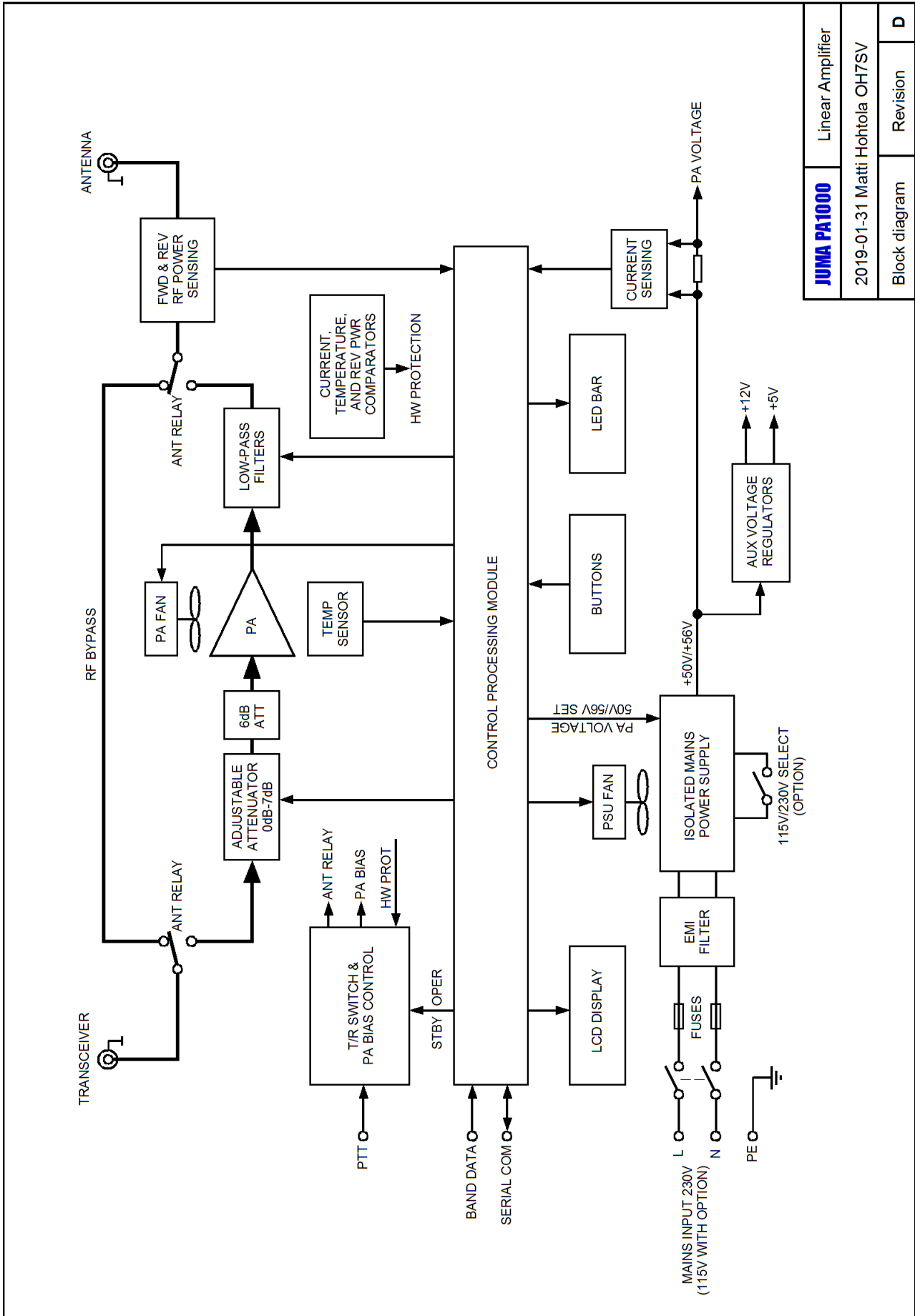

JUMA PA1000	Linear Amplifier
2019-01-31 Matti Hohtola OH7SV	
Block diagram	Revision
	D

LIMITED TWO (2) YEAR WARRANTY - ONE (1) YEAR MOSFET WARRANTY

JUMA PA1000 is covered by warranty to be free of defects in manufacturing and materials, including replacement parts and service labor, for a warranty period of two (2) years, except for the RF power amplifier MOSFET which is covered for a warranty period of one (1) year.

The warranty extends to the original purchaser only and is non-transferrable. It is effective as of the date the product is shipped.

During the warranty period JUMA will repair or replace any defective part or parts of the product, without cost to the purchaser, and correct any malfunction caused by the defective parts or materials.

Any attempt by the user to perform repairs or modify the product during the warranty period voids the warranty. Warranty coverage excludes damage determined to be caused by lightning or failure to comply with the instructions and warnings described in the user manual.

At any time, including during the warranty period, shipping costs to send a product to JUMA for repair are the responsibility of the customer. Any shipping damage caused by improper packaging will not be covered under warranty and is the responsibility of the product owner.

This warranty does not extend to any product that has been damaged or rendered defective or nonoperational due to accident, misuse or neglect, modification or intentional damage. Also not covered is reimbursement for loss of use, inconvenience, or cost of unauthorized service.

This warranty does not extend to non-JUMA equipment or components used in conjunction with our products. Any such repair or replacement is the responsibility of the customer. JUMA will not be liable for any special, indirect, incidental or consequential damages, including but not limited to any loss of business or profits.

Appendix 1.

Elecraft KX3 + PX3 Panadapter + JUMA PA1000 combination



PX3 and KX3

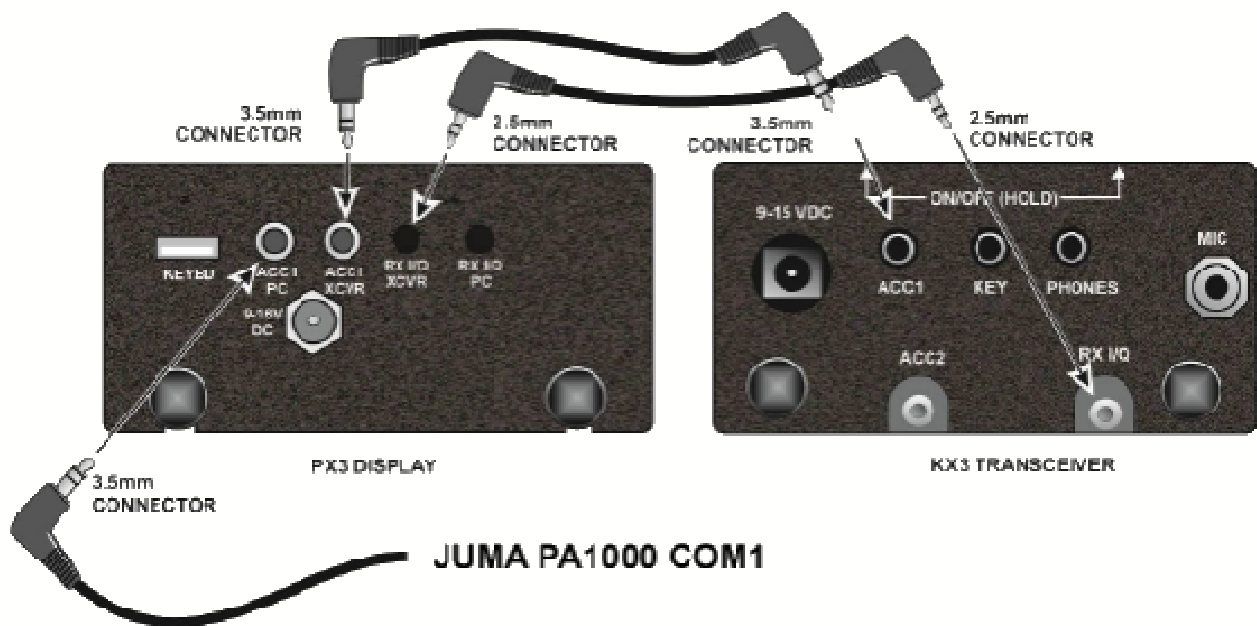

Install the cables as shown in the picture and set the all the baud rates to 38400.

Note. PTT cable from KX3 to PA1000 is not shown in the picture, see the previous pages for the PTT cable.

Appendix 2.

JUMA COM HUB

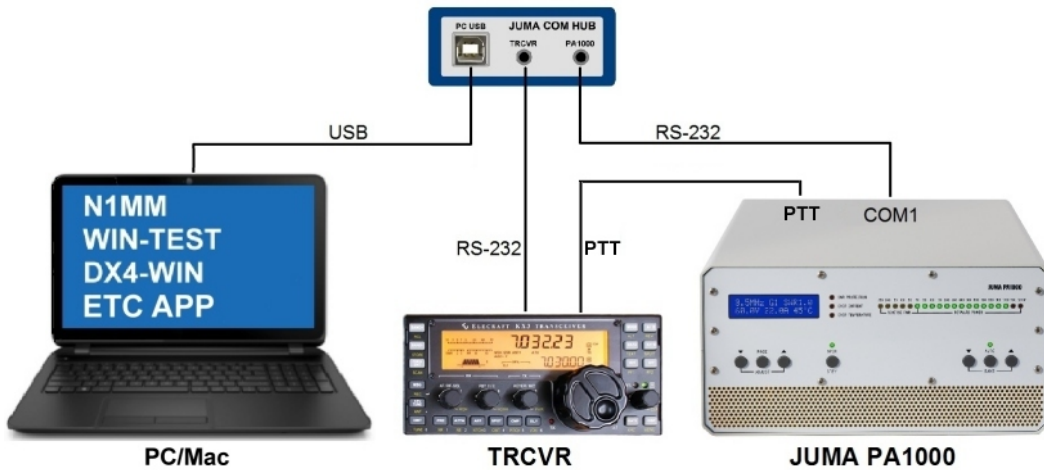

Typical JUMA COM HUB setup

JUMA COM HUB provides a connection between your PC/Mac software, transceiver and JUMA PA1000. It will share the single serial COM port of your transceiver. PC/Mac and transceiver are seamlessly connected together while JUMA PA1000 is tracking the transceiver band. JUMA COM HUB is powered by the USB cable and you don't need a USB - RS232 converter because that is built in to JUMA COM HUB. We are using FTDI USB chipset. The USB COM driver will be installed automatically when you plug in COM HUB to your PC. The green LED will be lit when the driver has been successfully installed and the USB port is ready to use. JUMA COM HUB supports Kenwood, Elecraft and Juma compatible CAT protocols. Additionally you can select a transceiver independent 50ms time out based mode** for other similar applications.

It is very easy to use

1. Select the baud rate with a jumper. Set the same baud rate to PC, TRCVR and PA1000 COM1. (No hand shaking)
2. Select the transceiver mode with the CONFIG jumper.
3. Connect a type B plug USB cable between PC and COM HUB and wait for driver installation. Watch the green LED.
4. Connect a serial cable from transceiver to COM HUB. The cable is illustrated in previous pages for your transceiver.
5. Connect a standard 3.5mm stereo audio cable between JUMA PA1000 and COM HUB.

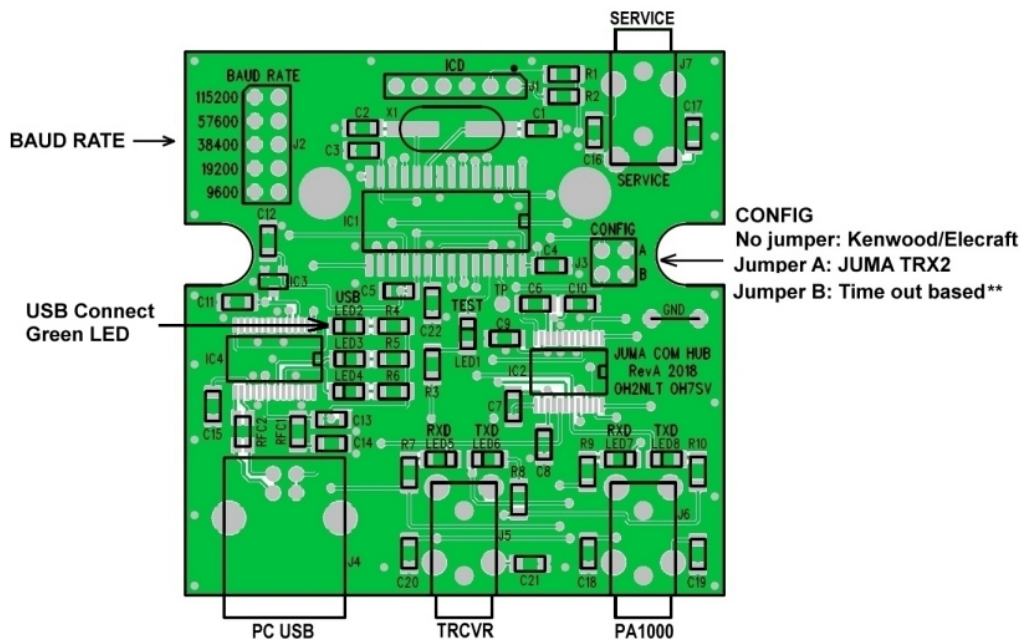

JUMA COM HUB Jumper Settings

Note1. JUMA PA1000 firmware must be v1.26 or newer.

Note2. Select "Hand Shaking: None" in PC/Mac application.

Note3. With Elecraft K3 and Yaesu use BCD band data and leave the COM port for PC use. **No COM HUB needed.**

Note4. With ICOM transceivers the open drain CI-V bus can be connected in parallel or. **No COM HUB needed.**