

Instruction Manual

HF ALL BAND
LINEAR AMPLIFIER

KL-1

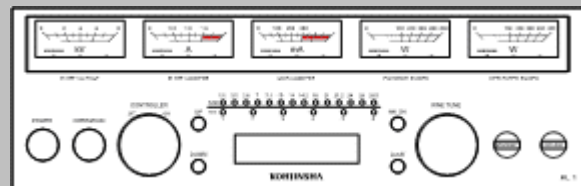

KL-1 is designed to use only for amateur radio purpose.
You need proper license to use this amplifier.
Please keep this manual after reading well.
You can also find available options in this manual

Thank you for choosing KL-1 as your amplifier.

KL-1 is the Kohjinsha's state of the art HF all band linear amplifier, which has preset tuning, heavy duty power supply, and remote controller.

We would like you to read this instruction manual very well before using your KL-1., which should help to get the maximum performance from this amplifier. We would also like you to use KL-1 for long time.

ACCESSORIES

Controller

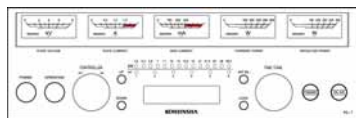

Remote Control Cable 7 m



Coaxial Cable with Connectors 7 m

AC Cable 3 m

R C A Plug 1pc

Lug Terminals For Power Supply 3 pc

Earth Lug 2pc

Instruction Manual

Table of Contents

1 . For your safety	2
2 . Main Unit (Power Supply and RF Deck)	4
3 . Controller	7
4 . Installation and AC Wiring	10
5 . External Connection	11
6 . Disassembling Controller	12
7 . Controller Setup and Connections	13
Settings for Models	15
8 . Controller Programming	22
9 . Antenna Selector	27
10 . PC Connection and Setting	29
11 . SteppIR Connection and Setting	31
12 . Operation (CW,RTTY,SSB)	32
13 . Transformer Wiring	33
14 . Specifications	34
15 . Disassembling Main Frame	35
16 . Circuit Diagrams	
RF Power Detector	37
Input Match	38
TX Inhibit Matrix(PCB3)	39
Servo Motor Control(PCB4)	40
HV Rectifier(PCB5) · On Delay(PCB6)	41
Servo Control Motor(PCB7)	42
RF P E P Meter	43
R F Deck	44
Power Supply	45
Controller	46
17 . Trouble Shooting	47

Read This Page For Your Safety

We would like you to read 『For Your Safety』 very carefully to prevent from accident.

We would also like you to keep this manual at your reachable place in order to read this anytime you need to check.



DANGER Negligence of this sign may cause serious injury or death of operator or people around the operator.

You must not place KL-1 in the nearby area in which inflammable object is used.
It may cause explosion or fire.



WARNING Negligence of this sign may cause serious injury or death of operator or people around the operator.

Negligence of cautions listed here may cause getting electric shock, leakage of electricity, or short circuit.

Use a proper plug to connect AC wire with AC outlet. Never connect wire directly with the outlet.

Have a ground earth before you connect AC plug with the outlet.

You should use proper grounding materials to have ground earth. Don't use gas pipe, water pip, etc.,.

You must not use broken AC wire or loose AC plug.

Negligence of cautions listed here may cause fire, unusual heat, electric shock, or major troubles of KL-1.

You must be careful with AC power line capacity. Never use extensions or piggy backed outlet.

Hold the plug when you pull out the plug. Never pull the wire.

Don't step on wires or coaxial cable. You must not put things on wires or coaxial cable.

AC wires or coaxial cable must not be twisted, pulled, broken, or given heat.

You should pull out AC plug while you don't use KL-1 for long time. Otherwise heat or fire may occur.

Don't make any metal or wire touch the parts in the amplifier, or you may cause fire or trouble.

Don't use proper primary AC, or you may cause fire, electric shock, or trouble.

Don't use KL-1 in the nearby area where medical equipments are used. The interference on these equipments may cause serious accident.

If you are noticed thunder storm, remove all the connections from KL-1. Once you hear thunder rolls, you are better not touch antenna cables.

Just in case you hear usual noise, smell, or see smoke, stop using KL-1. If you continue using under such conditions, you may cause fire, get electrical shock, or trouble. Remove AC plug from the outlet, and make sure no more fire, smell, or smoke, contact us or our agent in your area.



CAUTION Negligence of this sign may cause your injurers, or may cause troubles with KL-1.

Negligence of CUASION sign may cause abnormal heat in the main unit, and then may make burnt, fire, trouble, or mechanically broken

Don t install KL-1 in the area with high humidity, dusty, airless.

Don t install KL-1 too close to a wall.

Don t block the vent hole of KL-1.

Don t install KL-1 in the area of having direct sun light, or heated air coming out.

Negligence of this CAUTION may cause fall down of KL-1, fire, injury, or trouble.

Don t move or install KL-1 by only one person.

Install on the very hard and stable place.

Don t put anything on KL-1.

Don t install KL-1 close to television set or radio.

You may cause interferences.

Don t touch KL-1 or AC plug with wet hands.

You may get electric shock.

Open the case only when you change settings.

Otherwise you may get injury, electric shock, or cause trouble

Don t transmit without antenna or dummy load.

That may cause fire, or trouble.

Don t drop or give wham KL-1.

That may cause injury, or trouble.

Don t use thinner, benzene, gasoline, or such farmable liquid when you clean KL-1.

That may cause color change, distortion of case, or removing paint.

When you want to clean KL-1, use soft cloth with thinned kitchen detergent.

2-1 Front Panel

Power Indicator

KOHJINSHA logo turns on with **GREEN** light when you connect AC plug with AC200V(220V, 230V, or 240V) and turn on the circuit breaker on the lower part of rear panel.

When you turn on by pressing POWER switch on the controller, the KOHJINSHA logo turns **RED**, which means you have high voltage on the tube.



2-2 Side Panel(Left and Right)

Snap Fastener

These are used when you need to remove side panels. Push down the hooks to unlock, then lift a panel to remove it.



2-3 Upper Panel

Ventilation Hole CAUTION

Hot air comes out of this hole to keep the tube proper temperature. Don't block air flow at anytime.

Otherwise you may give damage the tube.



2 . Main Unit

2-4 Rear Panel(Upper Part)

ANT Connectors(Output)

There are six antenna connectors to use type-M(PL-259) connector. You can select which output to use from the controller.

GND terminal

Use this terminal to connect KL-1 to a good earth

ground for safety.

Good earth ground should prevent electric shock

accident or RF interferences.

Use a earth lug supplied with KL-1.

INPUT Connector

This is to connect with your transceiver(transmitter)

RF out terminal.

Use the 7m coaxial cable that is supplied with KL-1 to get optimum performance.

REMOTE

This Amphenol 5OP is to connect with the controller by using 7m accessory cable that is supplied with KL-1..Push in firmly and make sure to lock it.

Ext ANT Selector

Use this connector to connect Ext Antenna Selector(Option)

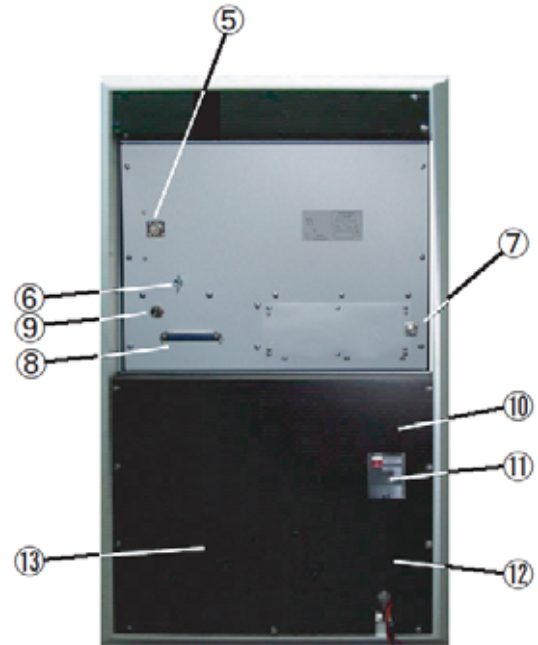

2-5 Rear Panel (Lower Part)

Fuse

5A and 3A fuses are used.

Once fuse is blown, resolve the cause first, and then reinstall the same value of fuse.

Circuit Breaker

Circuit Breaker is tripped by equipment as soon as it detects failure of KL-1 like short circuit or over current. Rated current is 50A.

Push up the lever of the circuit breaker until you hear the click noise after you fix the trouble.

Primary AC Power Connection Terminals

Apply primary AC200V(220,230,or 240V) to this 3 P terminal. Use thicker than AWG# 8. Cable. Center is for GND connection. Apply AC to both side.

Ventilation Hole CAUTION

This is for KL-1 to intake outside air. Don't block this with anything.

3 . Controller

3 - 1 Front Panel

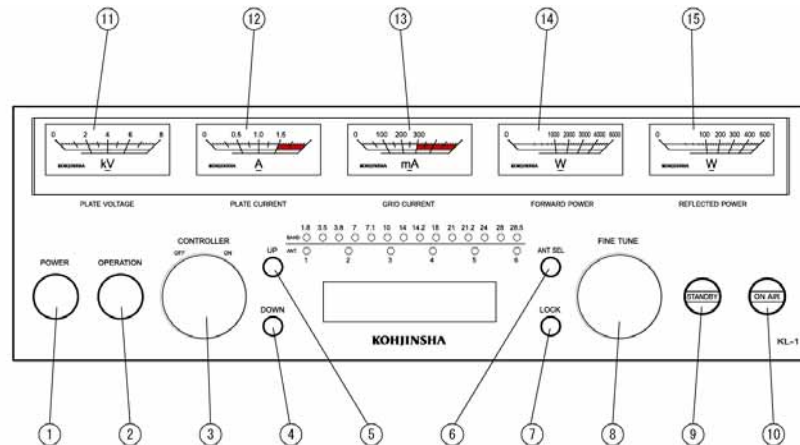

POWER SWITCH

Whole system power is made " ON / OFF " by Power Switch.

This switch toggles ON " OFF " alternately.

The blue lamp of the circumference of a button lights up when KL-1 s power on.

The blue lamp of the circumference of a button goes out when KL-1 s power off.

OPERATION SWITCH

When the KL-1 is detuned or changed band with OPERATION SWITCH is turned on, servo-motor automatically moves to tune on the band. STBY lamp will light when tuned.

Set the Fine Tune knob to stay center.

Operate with this OPERATION SWITCH ON usually.

If you don t use KL-1 (through the amplifier), press this switch to put the blue lamp out.

In this mode band change of the exciter won t let KL-1 to tune.

CONTROLLER SWITCH

This switch works to antenna selection switch while KL-1 is powered off.

You need to keep this switch on for antenna relays to work during KL-1 s power off..

DOWN SWITCH

You can move band downward with this switch. Press once moves down to one lower band.

UP SWITCH

You can move band upward with this switch. Press once moves up to one upper band.

ANT SEL SWITCH

This switch changes connectors on the rear panel. Each press change from ANT1 to ANT6 sequentially. LED1 to LED6 work together with this switch.

LOCK SWITCH

You can not select antennas manually if this switch is turned on. You can change antennas from your transceiver or PC.

FINE TUNE

When you need to fine tuning, turn this knob to get maximum power. Place this knob at center position normally.

When you fine tune, you MUST drive with 50W or little lower.

Because in order to prevent contacts of the variable inductor getting damaged by big amount of power and current.

STAND BY

This lamp shows green light on when KL-1 is ready to use after band change.

ON AIR

This lamp lights red while transmitting.

PLATE VOLTAGE

Plate voltage meter.

PLATE CURRENT

Plate current meter.

GRID CURRENT

Grid current meter.

FORWARD POWER 5KW

Forward power meter.

REFLECTED POWER 500W

Reflected power meter.

3 - 2 Rear Panel

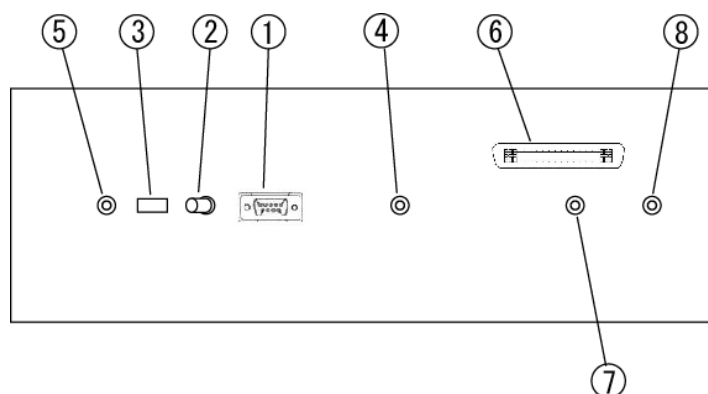
**RS232C Connector**

This is used to connect with the radio that has RS232C interface.
Use RS232C straight cable.

PC RIG Switch

You can control KL-1 from either PC or transceiver.
Use this switch to select your favorite way.

USB Terminal

This is to connect with your PC.
Just connect with your PC. KL-1 works without drivers.

CI-V Terminal

You can connect with ICOM radios using this terminal. Use cable with 2p plug.

SteppIR Terminal

When you connect with SteppIR, use this terminal.
Use the cable to use for this purpose. (2Pプラグ・D-Sub9P)
More description regarding this cable in page 33.

REMOTE Connector

For Amphenol 50P connector with the supplied 7m connection cable.
Push the connector to the end and make sure if it is locked.

TX CONT

Connect with your transceiver s remote terminal(TX GND).

GND Terminal

Use this terminal to connect KL-1 to a good earth ground for safety.
Good earth ground should prevent electric shock accident or RF interferences.
Use an earth lug supplied with KL-1.

4 . Installation and AC Wiring

There is a ventilation hole to take air in on the rear panel.

Do not block this hole with anything.

Installing KL-1 in dusty or high humid area may cause high voltage leakage.

Primary AC connecting wire is required thicker than AWG# 8.

If you do not use proper wire, you may have fire from the heat.



Primary AC Connection

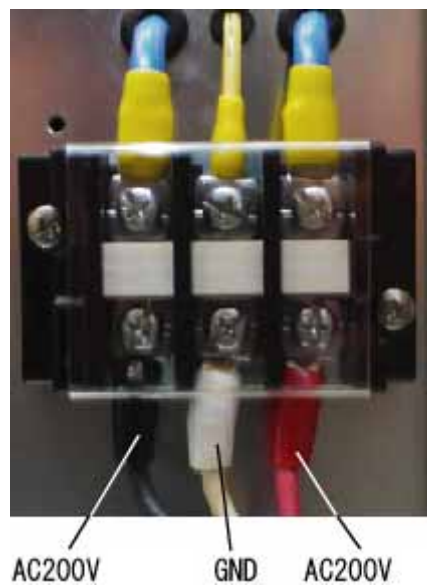

5 . External Connections

This shows external connections.

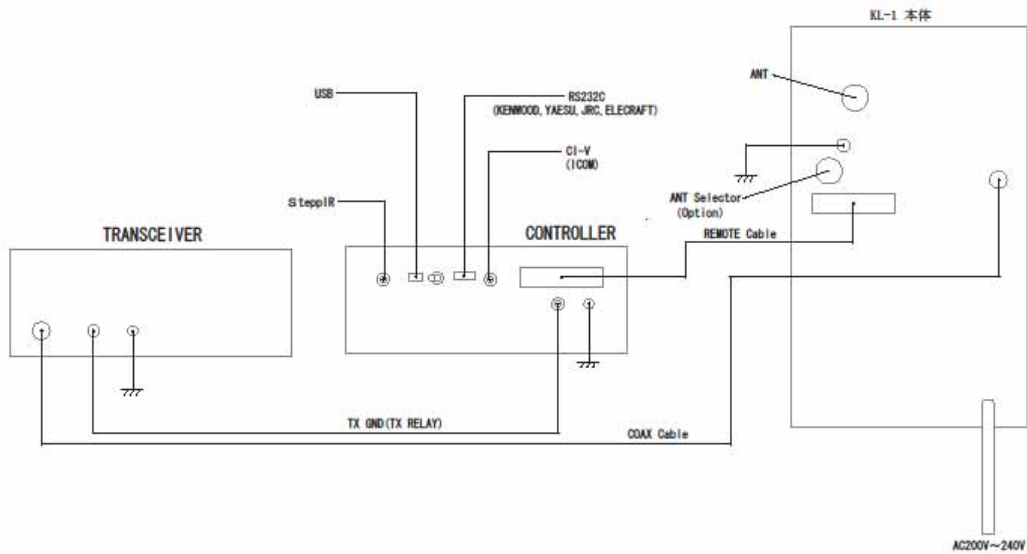

6 . Controller Disassembling

Unscrew 6 nuts on the cover. Lift the cover and you can take it off..

Be careful in order not to get hurt.

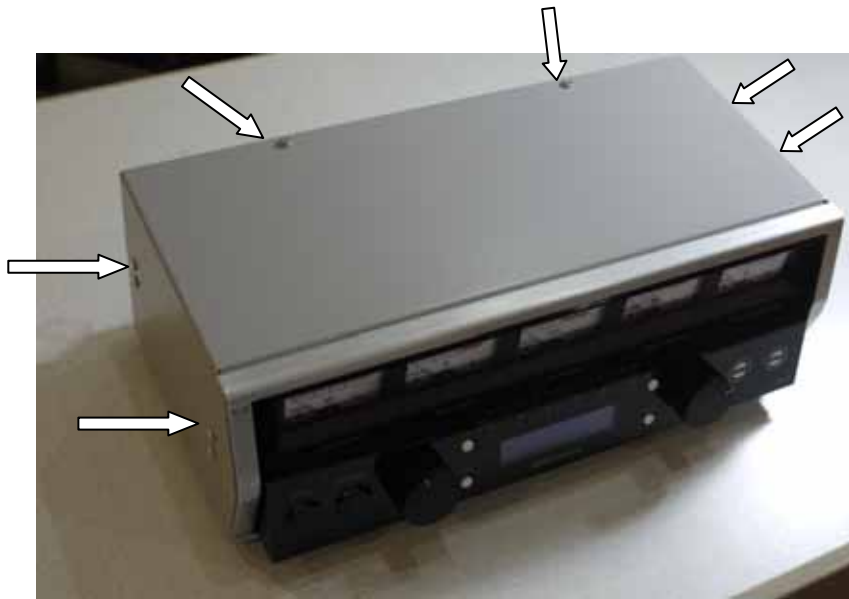

7 . Controller Setup and Connections

You need to set up the controller settings and memory settings before you connect with your transceiver.

We would like to explain how to set up KL-1 controller to get full control KL-1 with your transceiver.

7-1 Boards in the Controller

You need to have proper jumper and memory setting in order to control KL-1 coordinating with your transceiver. The picture shows pin header locations on the CPU board.

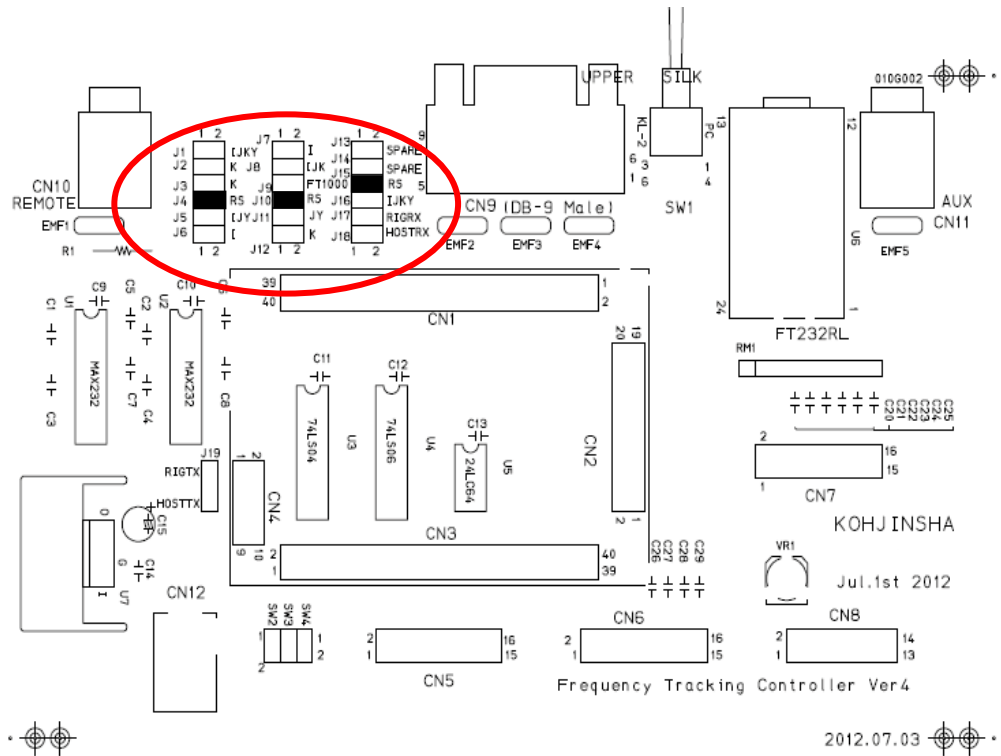

7-2 Jumper Pin Settings and Connection for Different Transceivers

In this section we show jumper pin settings and cable for connection with different transceivers.

shows jumper pin position.

doesn't effect settings with or without jumper pin.

Each figure s bottom side is front side of the controller.

() You can not have both RS-232C connector and CI-V connector on the rear panel of KL-1. If you have both connectors, control function doesn t work. You should use either interface.

7-3-1 ICOM (CI-V)

1. Jumper Pin Settings on Tracking Board

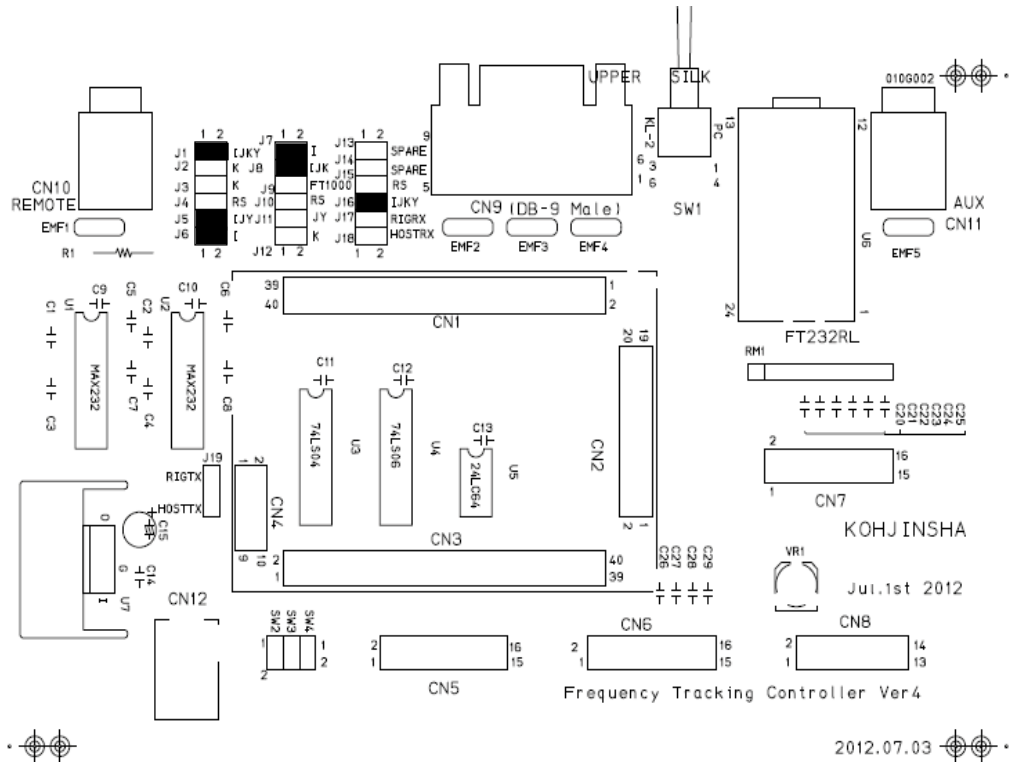

2. Connecting with Your Transceiver

Connect remote jack of your ICOM transceiver with CI-V jack of KL-1 controller.

Use 2pin plug on both side with shielded cable.



Transceiver REMOTE
3.5 2p plug

KL-1 CI-V
3.5 2p plug

7-3-2 YAESU FTDX9000 • FT2000 • FTDX5000 • FT1000MP • MK-V

1. Jumper Settings on Tracking Board

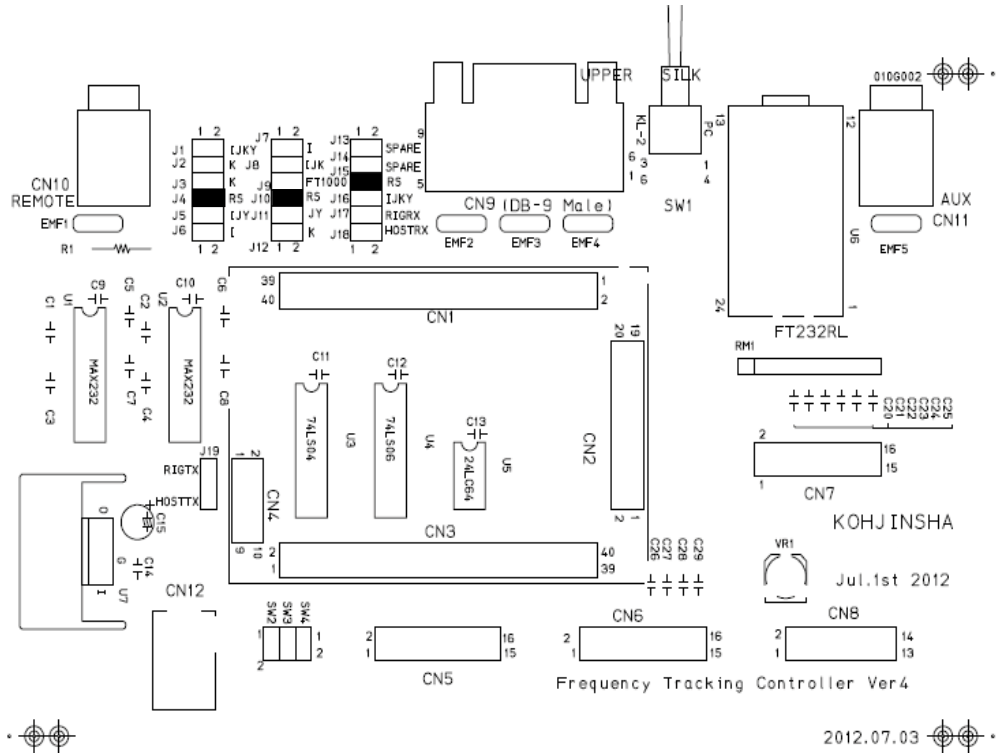

2. Connecting with Your Transceiver

Use straight cable with DSUB9 female connector on both sides. You need to use only pin 2,3 and GND.

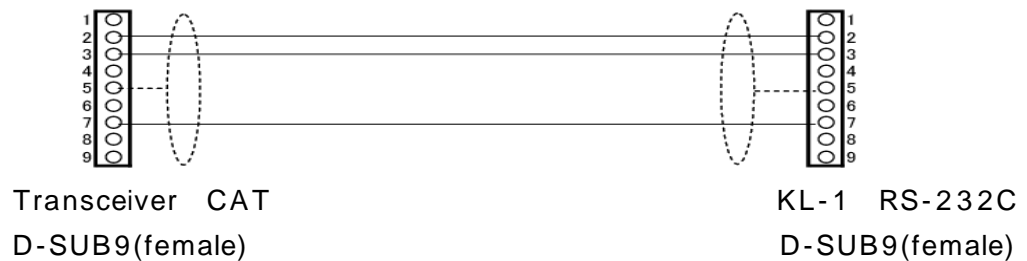

7-3-3 YAESU FT-1000 • FT-1021

1. Jumper Setting on Tracking Board

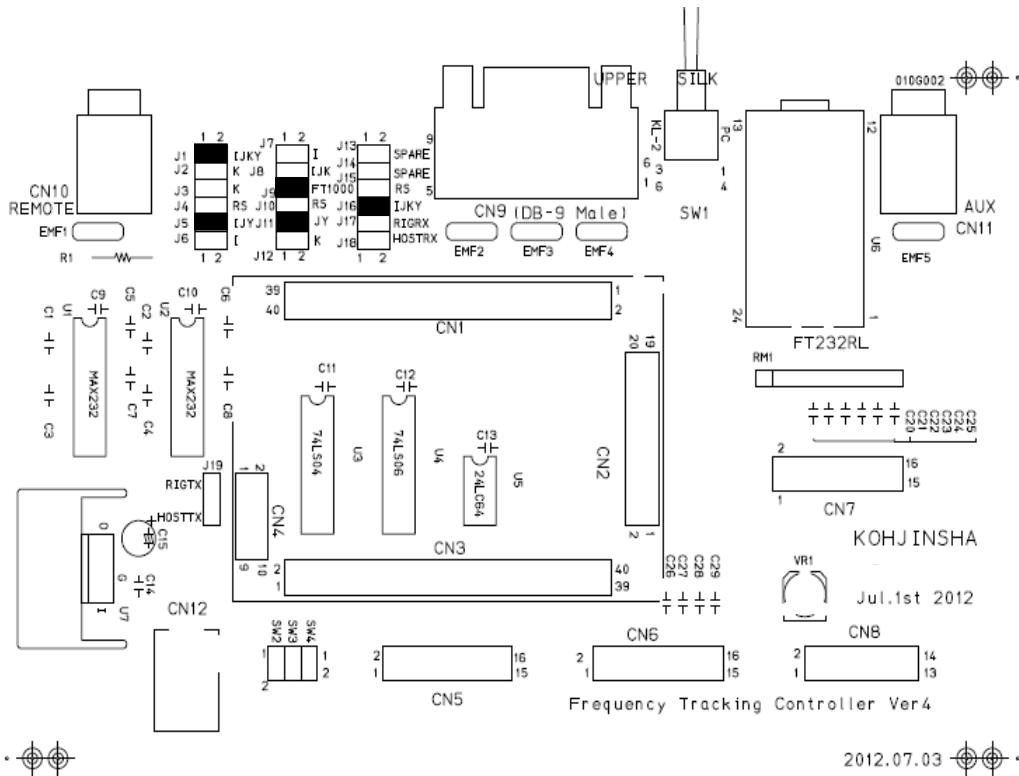

2. Connection with Transceiver

Connect CAT connector of your transceiver with RS232C connector of KL-1.
 Use DIN 6pin connector for transceiver and RS232C(female) for KL-1
 You need to use only pin 2,3 and GND.



Transceiver CAT
DIN6Pin

KL-1 RS-232C
D-SUB9(female)

7-3-4 KENWOOD TS2000 • TS870 • TS590 • TS480 • TS990

1. Jumper Settings on Tracking Board

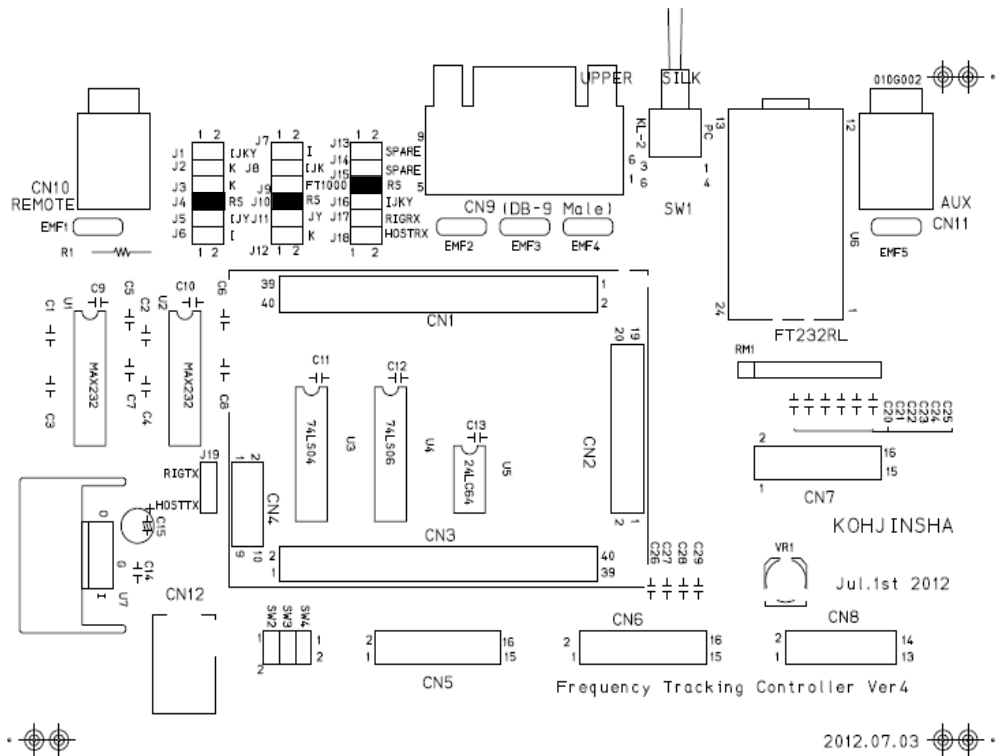

2. Connection Transceiver with Controller

Connect COM connector of transceiver with RS232C connector of KL-1

Use straight cable with DSUB9 female connector on both sides. You need to use only pin 2,3 and GND.



7-3-5 KENWOOD TS-950 • TS-850

1. Jumper Settings on Tracking Board

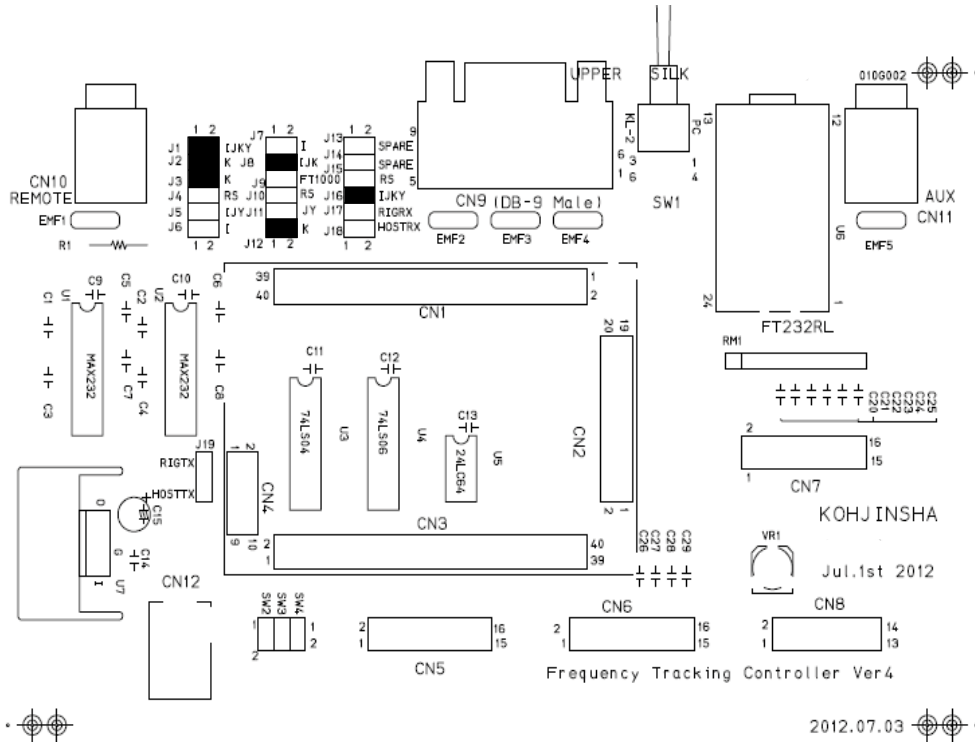

2. Connection Transceiver with Controller

Connect ACC1 of transceiver with RS232C connector of KL-1.

Use only pin 2,3, and GND with DIN 6pin for transceiver, and RS232C female for KL-1.

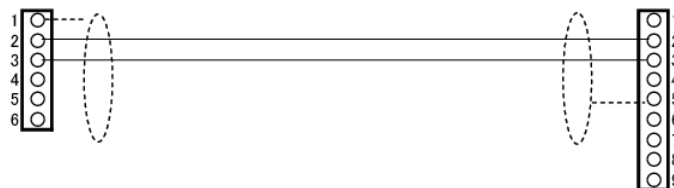

Transceiver ACC1
DIN6pin

KL-1 RS-232C
D-SUB9(female)

7-3-6 Elecraft K2 • K3

1. Jumper Settings on Tracking Board

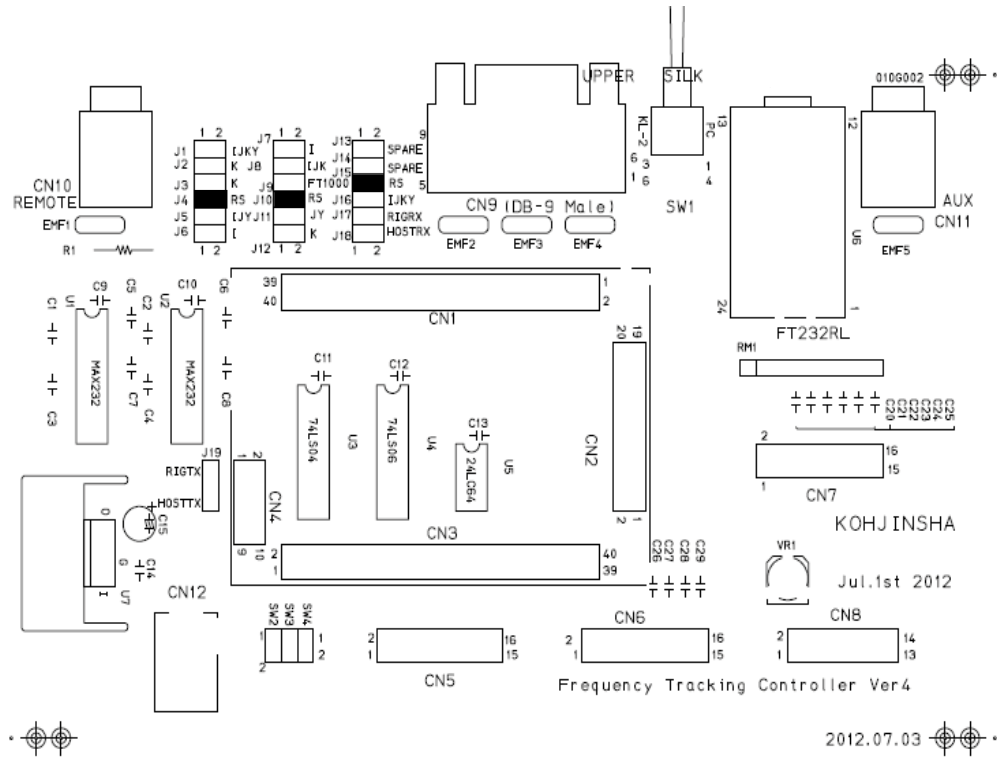

2. Connection Transceiver with Controller

Connect CAT connector of your transceiver with RS232C connector of KL-1. Use D-SUB9(male) connector for transceiver and D-SUB9(female) for KL-1. You need to use only pin 2,3 and GND.



7-3-7 JRC JST-145 • JST-245

1. Jumper Settings on Tracking Board

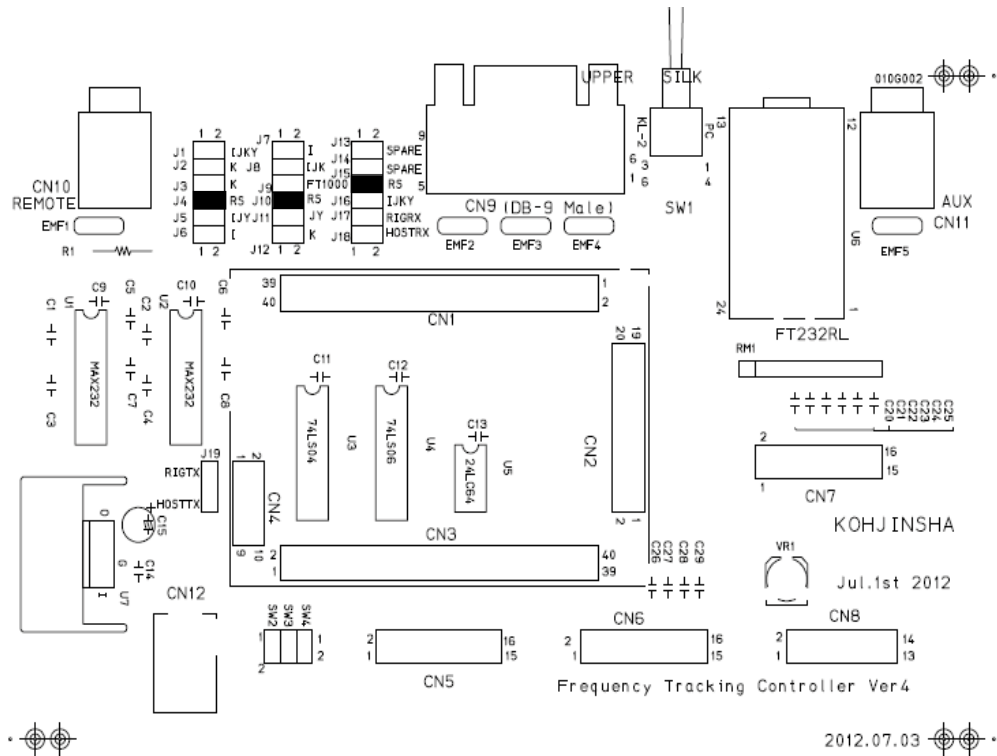

2. Connection Transceiver with Controller

Connect RDS232C connector of your transceiver with RS232C connector of KL-1.

Use D-SUB25(male) connector for transceiver and D-SUB9(female) for KL-1
 You need to use only pin 2,3 and GND.

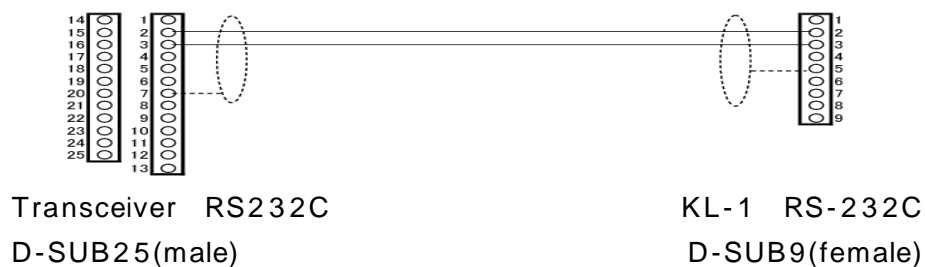

8 . Controller Programming

8 - 1 Memory

KL-1 has memory to store setting information. You can store your transceiver information.

8-2 Initializing Memory

Reset KL-1 memory to make it factory setting.

Turn on power switch of controller while pressing UP button of controller to make the memory written mode. You need only controller this time. You don't have to turn power on KL-1.

00:Exciter Type
:

After you see above indication on LCD, press DOWN button for a short while until you see the indication below. Now the memory is default set up.

Turn off power and turn it on again, and controller has default settings.

Write Default
Please Power OFF

8-3 Change Memory

Turn on power switch of controller while pressing UP button of controller to make the memory written mode.

00:Exciter Type
:
(note)

(note) displays the actual set up of the memory.

- UP SW : Upper part of LCD display scrolling like 01, 02, 03,
- DOWN SW : Upper part of LCD display scrolling like 03, 02, . . .
- ANT SEL SW : Bottom part of LCD scrolling toward plus.
- LOCK SW : Bottom part of LCD scrolling toward minus.

After setting up like above, press UP SW for a while until you see the message below on LCD. Now you set up your system in the memory.

Write Complete
Please Power OFF

Turn power off and then turn power on again.

KL-1 works under the new settings.

8-4 Memory Setting Table for Different Transceivers**.ICOM(All ICOM radios)**

00:Exciter Type	00:ICOM
01:Port1 BAUD	001:1200 ~ 016:19200bps(recomended:9600)
02:Stop bit	01:1 Stop bit

YAESU**FTDX9000 • FT2000 • FTDX5000**

00:Exciter Type	016:YAESU AI
01:Port1 BAUD	004:4800
02:Stop bit	02:2 Stop bit

MK-V • FT1000MP

00:Exciter Type	001:MK-V 1000MP
01:Port1 BAUD	004:4800 (fixed)
02:Stop bit	02:2 Stop bit (fixed)

FT1000D , FT1021

00:Exciter Type	010:FT-1000
01:Port1 BAUD	004:4800 (fixed)
02:Stop bit	02:2 Stop bit (fixed)

KENWOOD**TS950 • TS850**

00:Exciter Type	006:TS-950_IF
	007:TS-950_AI (1)
01:Port1 BAUD	004:4800 (fixed)
02:Stop bit	02:2 Stop bit (fixed)

(1)Chose 007 if your TS950SDX , or TS850 output power becomes half with 1.6 second interval during transmission.

TS2000 • TS990 • TS870 • TS590 • TS480 etc.

00:Exciter Type	005:KWD/K2/K3_AI
01:Port1 BAUD	004:4800
02:Stop bit	01:1 Stop bit

Elecraft**K2 • K3**

00:Exciter Type	0 05:KWD/K2/K3_AI
01:Port1 BAUD	004:4800
02:Stop bit	01:1 Stop bit

JRC**JST-245 • JST-145**

00:Exciter Type	008:JST-245_RS
01:Port1 BAUD	004:4800
02:Stop bit	01:1 Stop bit

8-5 Memory Setting Table

Setting Item	Setting Details	
00 : Exciter Type	<p>000 : ICOM 001 : MK-V 1000MP 002 : FT-100 003 : FT-920</p> <p>004 : KWD/K2/K3_IF 005 : KWD/K2/K3_AI</p> <p>006 : TS950/TS850_IF 007 : TS950/TS850_AI</p> <p>008 : JST-245_RS 009 : JST-245_Lin</p> <p>010 : FT1000 011 : FT767 012 : Not Use 013 : Not Use 014 : Not Use 015 : YAESU IF 016 : YAESU AI 017 : FT-847 018 : Stand Alone</p>	<p>CI-V(All ICOM transceivers w/CI-V) FT1000MP,MK-V,FT1000MP FT-100 FT-920</p> <p>TS2000,TS990,TS870,TS590,K2,K3 TS2000,TS990,TS870,TS590,K2,K3 005 is recommended, however 004 should work better with 004 depending on logging software.</p> <p><u>Choose 007 if your TS950SD(X) or TS850 output power becomes half with 1.6 second interval during transmission.</u> <u>You lose memory frequency tracking with this setting.</u></p> <p>JST-145/JST-245 KL-1 doesn't use this setting.</p> <p>FT-1000D,FT1021 FT767 KL-1 doesn't use this setting. KL-1 doesn't use this setting. KL-1 doesn't use this setting. FT2000,FTDX5000,FTDX9000 FT2000,FTDX5000,FTDX9000 FT-847 In case of the your radio has rotary switch for band selection, or the radio doesn't have function to work with KL-1 interface.</p>
01 : Port1 BAUD	<p>Communication baud rate set up with transceiver Select 1200bps ~ 38400bps</p> <ul style="list-style-type: none"> • YAESU transceiver,TS950, and TS850 004 : 4800 • ICOM 001 : 1200 ~ 016 : 19200 (recommended rate 008 : 9600) • FT2000,FTDX5000,FTDX9000,TS2000,TS990,TS870,TS590 etc. 004 : 4800 ~ 032 : 38400 	
02 : Stop bit	<p>Set stop bit number.</p> <ul style="list-style-type: none"> • YAESU, and 4800BAUD KENWOOD transceiver 02 : 2 stop bit • Transceivers not listed as 2 stop bit. 01 : 1 stop bit 	

Setting Item	Setting Details
03 : Logging Soft	<p>00 : Not Use 01 : CT/ARCP-2000 02 : Zlog 03 : HAM Log 04 : Logger32 05 : Mixw2 06 : FTC Logger 07 : FTC Logger CT</p> <p>• Control from your PC (by logging software) ICOM 00 : Not Choose this setting to use logging software YAESU 01 ~ 05 choose your logging software KENWOOD 01 ~ 05 choose your logging software</p> <p>• Control from your rig ICOM 00 : Not Use Choose this setting to use logging software YAESU 06 : FTC Logger HAMLOG、ZLOG、Logger32、Mixw2 07 : FTC LoggerCT LoggerCT KENWOOD 00 : Not Use Next you need to setup 00:Exciter Type. 005 : KWD/K2/K3_AI or 007 : TS950/TS850_AI for HAMLOG、Zlog, CT 004 : KWD/K2/K3_IF or 006 : TS950/TS850_IF for Logger32 と Mixw2</p>
07 : Port2 BAUD	<p>SteppIR 001 : 1200 ~ 016 : 19200 (Factory Setting 008 : 9600) SteppIR default 9600bps</p>

9 . Antenna Selector

9-1 Antenna Selector (Option)

KL-1 has Ext 6 antenna selector connector (7P Jack). You can program in order for KL-1 to select any output connector for the transceiver frequency (band). You can tell which band was selected by numbered LEDs.

9-2 Antenna Selector Setup

Turn KL-1 controller power on.

Band.Sel	MHz (Note 2)
Ant.Lock	1

After the above message is displayed, press LOCK button for a while. Message below should come out. Now you can select antennas.

Band.Sel	MHz (Note 2)
Ant.Sel	1

Next press ANT SEL button and you can select RF output connectors for the frequency (band).

One press ANT SEL button select RF output connector as 1 2 3 4 5 6 1 order.

After you select an antenna(RF output connector) , LOCK ボタン press LOCK button, and the message below comes out. Setup is done.

Band.Sel	MHz (Note 2)
Ant.Lock	(Note 3)

(Note 2) should be frequency

(Note 3) should be RF output connector number.

(EXAMPLE) In case you want to change output connector number from 1 to 3 for this frequency (MHz BAND),

KL-1 power on. Display shows as below.

Band.Sel	MHz
Ant.Lock	1

Press LOCK button for a while., and you see the display show below.

Band.Sel	MHz
Ant.Sel	1

Press ANT SEL button twice. Each pressing make the number change by one.

This case the number becomes 3.

Band.Sel	MHz
Ant.Sel	3

Press LOCK button. Setup is done if the display shows as below.

Band.Sel	MHz
Ant.Lock	3

10 . PC Connection and Setting

10-1 Connection with P C

Use mini USB connector on the rear panel of KL-1 to connect with PC.

If you use KL-1 without logging software, turn the SW on the rear panel to [RIG] side before turning KL-1 power on.

If you use KL-1 with logging software, turn the SW on the rear panel to [USB] before turning KL-1 power on so that the logging software can communicate your transceiver and KL-1.

In this case your transceiver cannot send band data to KL-1 without logging software is running.

You need to setup KL-1 itself to use with PC.

You can connect PC with the radio that has USB connector like TS-590.

10-2 P C Connection

Make	Transceiver	Memory Setting	Note
ICOM	CI-V All ICOM transceivers	You don't have to setup for ICOM transceivers.	With Logger32 in case KL-1 switches to another band, and come back quickly to the original band while tuning your transceiver frequency dial, turn off CI-V transceiver of your ICOM transceiver. If you set so, KL-1 doesn't coordinate with your transceiver without Logge32.
YAESU	FT-1000MK-V FT-1000MP FT-1000	03:Logging Soft Choose the logging software that you want to use. To user HAMLOG you need to put check mark for FT1000MP in HAMLOG input configuration, and set the timer command 5.	Make sure the CAT indicator of your transceiver is blinking. If CAT indicator is not blinking, tracking function doesn't work. When you use HAMLOG, you should have HAMLOG input window, otherwise CAT doesn't work.
YAESU	FTDX-9000 FT-2000 FTDX-5000	03:Logging Soft Choose the logging software that you want to use To use HAMLOG you need to put check mark for FT2000/9000 in input configuration , and set the timer command 0. Select KENWOOD in HAMLOG configuration.	You may have trouble of tracking function depending on how you use the logging software.
KENWOOD	TS-950 TS-850	00:Exciter Type Select 007:TS950/850_AI, 03:Logging Soft choose your logging software.	Turn power transceiver on, and KL-1 on, then initialize your logging software. Make sure you see the transceiver frequency(RX band) on display.
KENWOOD	TS-2000 TS-870 TS-480 TS-570 TS-990	00:Exciter Type Select 005:KWD/K2/K3_A I 03:Logging Soft Choose your logging software.	Turn power transceiver on, and KL-1 on, then initialize your logging software. Make sure you see the transceiver frequency(RX band) on display.
J R C	JST-145 JST245	Logging software is not available.	

1 1 . SteppIR Connection and Setting

For ANY Manufacturer s transceiver you need t to set SteppIR 「Transceiver Setup」 「ICOM」.

Set SteppIR baud rate as same rate as KL-1 is. (Memory setup 007:Port2BAUD)
Default setting of Both KL-1 and SteppIR are 9600bps.

Use ICOM cable supplied by SteppIR Antenna Inc.,. Plug it to SteppIR jack on rear panel of KL-1 controller.

Transceiver Setup Mode



Setup Baud 9600



Set Mode 「ICOM」



1 2 . Operation(CW,RTTY,SSB)

3CX3000A7 has a directly heated filament as a cathode.

After turned on power, you have to wait only a few seconds to transmit if tuning is done.

During the OPERATION switch on, servo-motor works to tune automatically if you change band.

(If OPERATION switch is off, KL-1 is **not** tuned automatically.)

You can not transmit until KL-1 is tuned.

(STBY lamp is off during tuning period.)

When tuning is done, STBY lamp gets GREEN. Now you can transmit.

(Note)

If you need to move FINE TUNE for adjustment, reduce driving power to about 50W.

Above action should prevent the moving contact of the variable inductor from getting deteriorated by high power and large current.

1 3 . Transformer Wiring

1. Remove AC cables from the AC power outlet or push down the lever of the circuit breaker on the backside of main frame in order for you not to get electric shock.

2. Removing left side panel.
Push down the lever of snap fasteners to unlock and lift the panel to remove it.

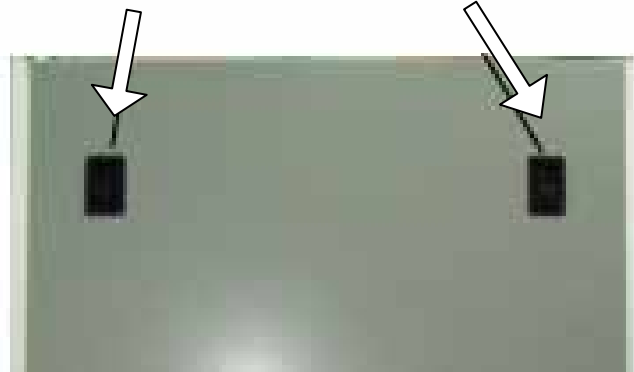

3. Removing left side panel, you can see primary connection of the high voltage transformer. You can change the connection to match your area.

 CAUTION

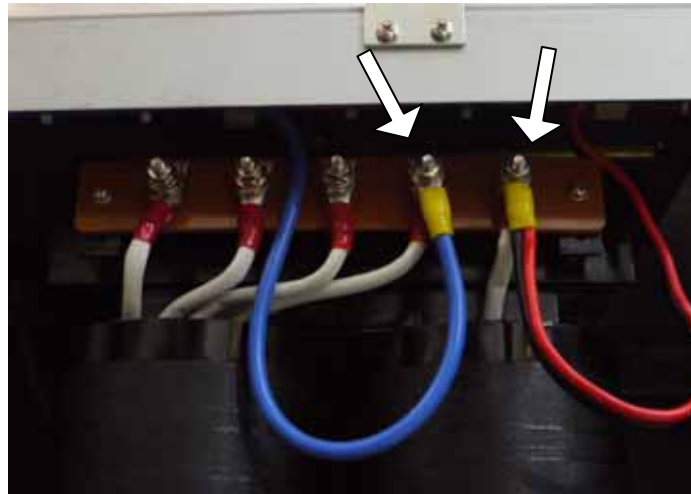

4. Make sure no wrong wiring or short circuit, and then put the left side panel to original position.
5. Push up the lever of the breaker or connect KL-1 AC plug with outlet.

1 4 . Specifications

Frequency Range	1. 8 0 0 MHz ~ 1. 9 9 9 MHz 3. 5 0 0 MHz ~ 3. 6 6 0 MHz 3. 6 6 0 MHz ~ 3. 9 9 9 MHz 7. 0 0 0 MHz ~ 7. 1 1 0 MHz 7. 1 1 0 MHz ~ 7. 3 0 0 MHz 1 0. 1 0 0 MHz ~ 1 0. 1 5 0 MHz 1 4. 0 0 0 MHz ~ 1 4. 1 5 0 MHz 1 4. 1 5 0 MHz ~ 1 4. 3 5 0 MHz 1 8. 0 6 8 MHz ~ 1 8. 1 6 8 MHz 2 1. 0 0 0 MHz ~ 2 1. 2 1 0 MHz 2 1. 2 1 0 MHz ~ 2 1. 4 5 0 MHz 2 4. 8 9 0 MHz ~ 2 4. 9 9 0 MHz 2 8. 0 0 0 MHz ~ 2 8. 3 0 0 MHz 2 8. 3 0 0 MHz ~ 2 9. 7 0 0 MHz
Operating Temperature Range	0 ~ + 4 0
Input Impedance	5 0 Unbalanced
Maximum Tuning Time	Approximately 30 seconds (From 1.8MHz to 28.300MHz or vice versa.) (Move to next band takes only a few seconds.)
Supply Voltage	A C 2 0 0 ~ 2 4 0 V (Single phase 5 0 / 6 0 H z)
Ground	Minus ground
Maximum Driving Power	2 0 0 W
Maximum Output Power	C W / R T T Y / S S B (P E P) : 4 K W (see NOTE)
Undesired Spurious Suppression	Less than - 4 0 dB
Dimension	Main Unit : Width 4 7 8 × height 8 0 0 × Depth 5 6 4 mm (Any object that come out from the surface are not included to measure.) Controller : Width 3 2 0 × Height 1 0 7 × Depth 1 8 7 . 5 mm (Any object that come out from the surface are not included to measure.)
Weight	Main Unit : 1 0 6 kg Controller : 3.5 kg

Note: You must follow your country's regulation regarding out put power.

Specifications were measured in the way that JAIA(Japan Amateur Industrial Association).
Specifications, outside appearances may be changed to improve without any notice.
Tuning time may change according to load condition.

1 5 . Disassembling Main Frame

1. Remove AC cables from the AC power outlet or push down the lever of the circuit breaker on the backside of main frame in order for you not to get electric shock.



2. Removing left side panel. Push down the lever of snap fasteners to unlock, and then lift the panel to remove it.

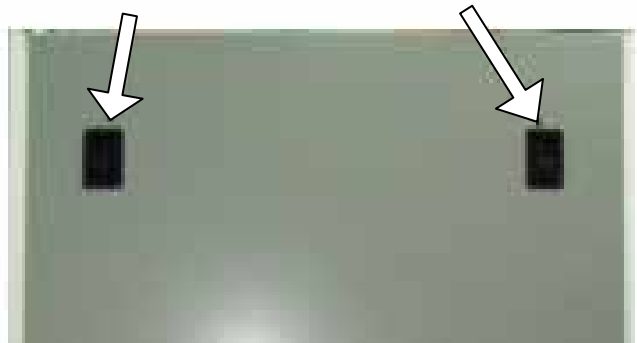

3. Removing four screws on each corners of the upper panel to take the panel off.

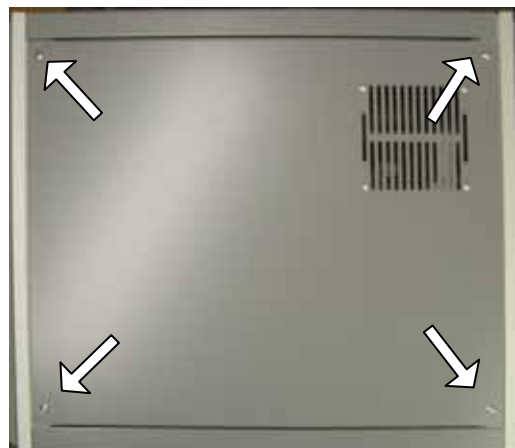

1. Removing nine screws to take off rear fan cover.

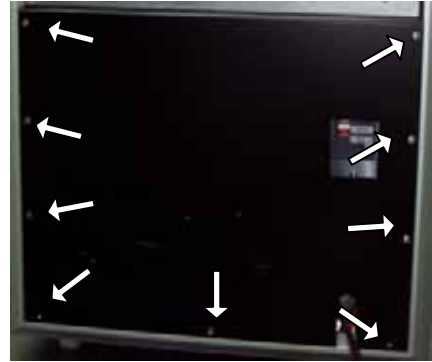

2. Remove four metal plate that are located lower part of both sides of RF deck.

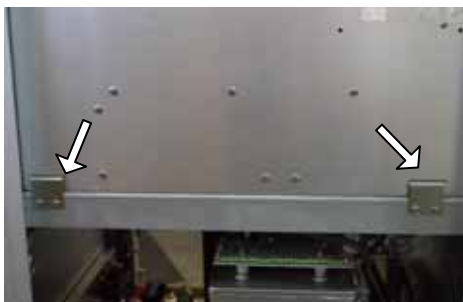

Remove HV connector, and 12 pin canon connector from RF deck. They are located right bottom of RF deck looking at from the front side.



3. Pull out RF deck to backward. (Please be careful in order not to get hurt yourself because RF deck is heavy.)



Slide RF deck this way.

1 6 . Circuit Diagram

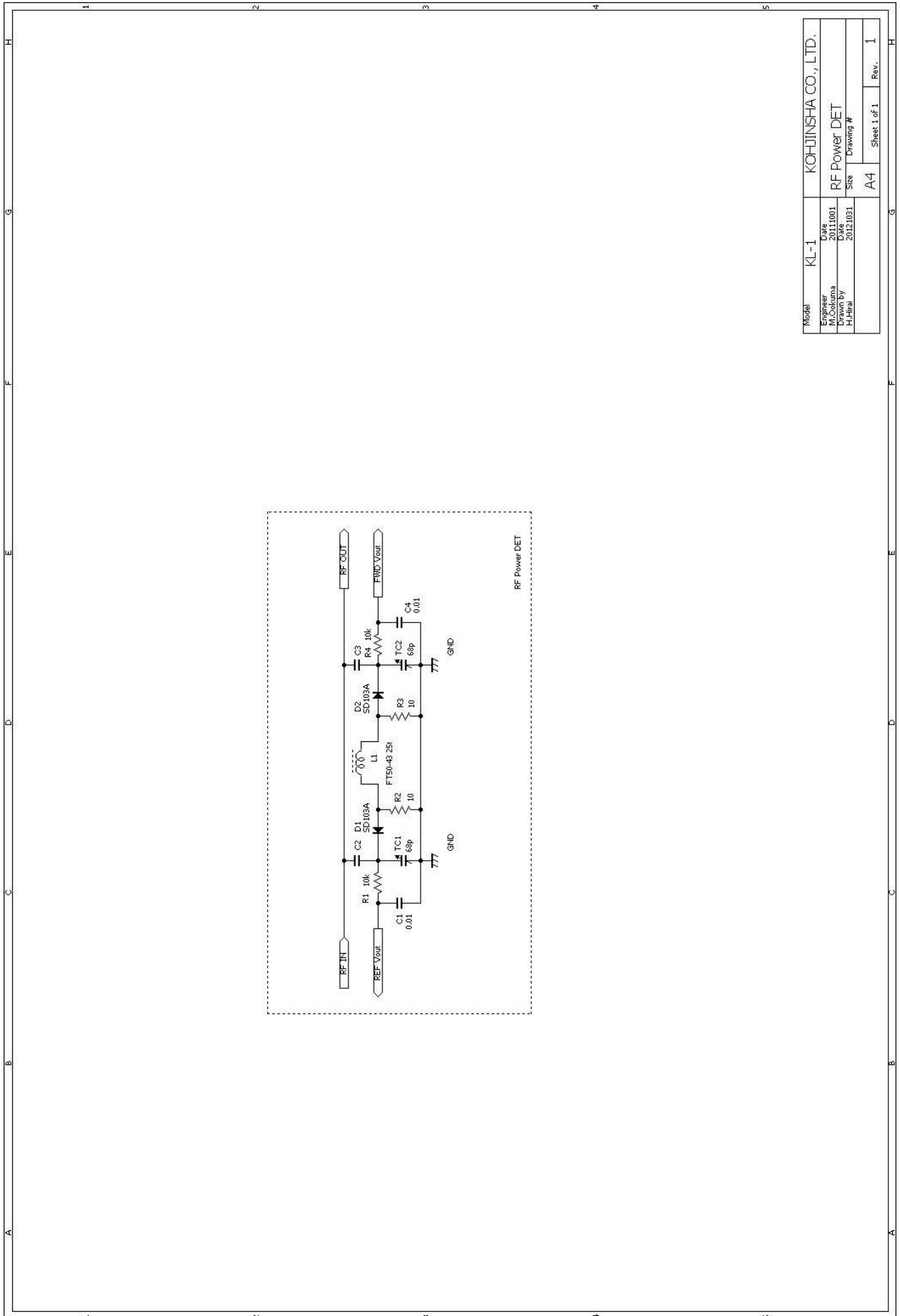

Model	KL-1	KOHJINSHA CO., LTD.	
Engineer	M. Yokuma	Date	2011.001
Drawn by	Y. Hara	Date	2012.031
Checked		Size	Drawing #
		Sheet 1 of 1	Rev. 1

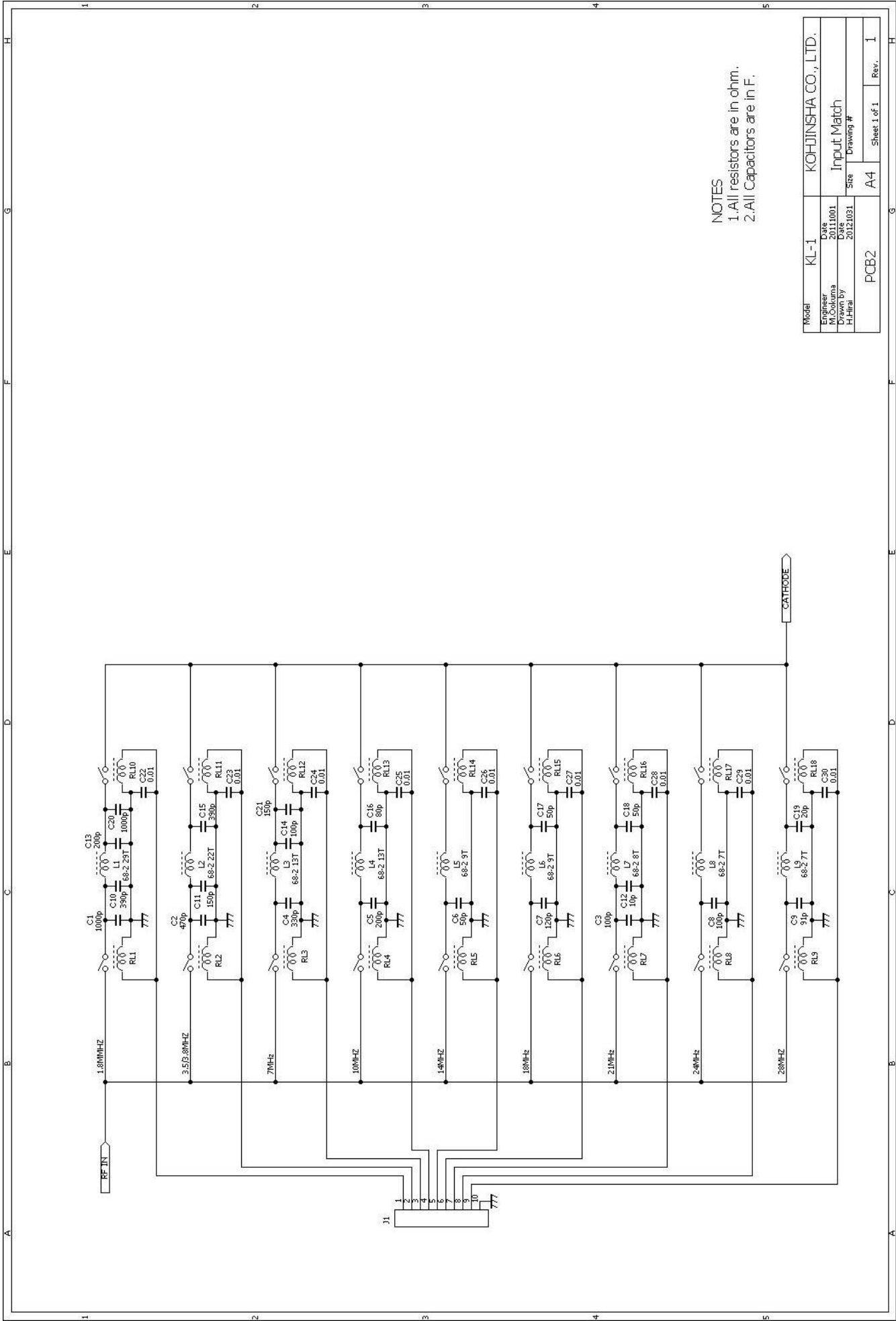

NOTES
 1. All resistors are in ohm.
 2. All Capacitors are in F.

Model	KL-1	KOHJINSHA CO., LTD.	
Engineer	M.Ookuma	Date	2011.001
Drawn By	H.Hirai	Date	2012.031
	PCB2	Size	A4
		Sheet 1 of 1	Rev. 1

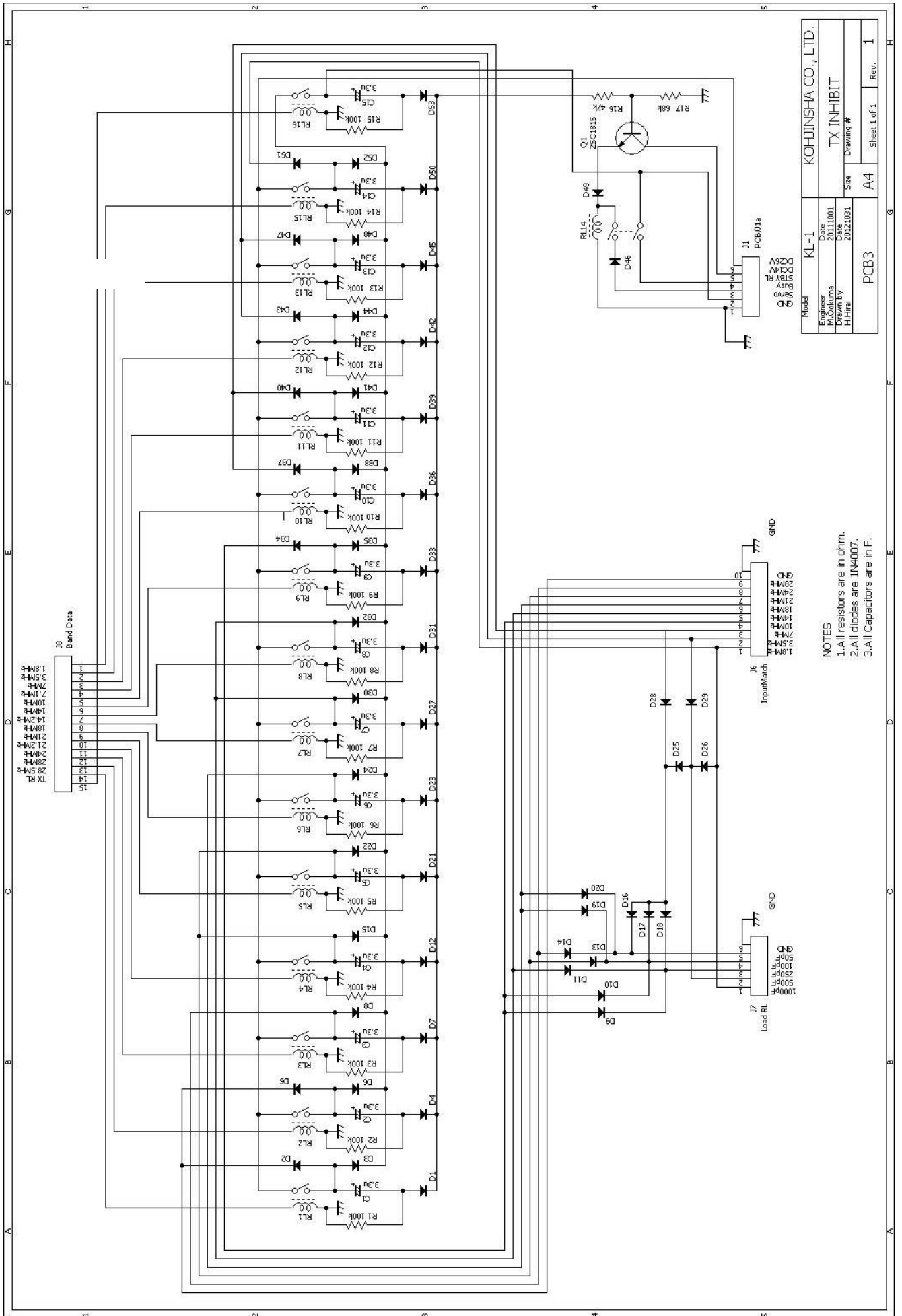

Model	KL-1	KOHJINSHA CO., LTD.	
Engineer	04.54.1515.00	Date	2012.10.31
Drawn by	H.Hira	Date	2012.10.31
Size	A4	Sheet	1 of 1
Drawing #	PCB3	Rev.	1

- NOTES
- 1.All resistors are in ohm.
 - 2.All diodes are 1N4007.
 - 3.All capacitors are in F.

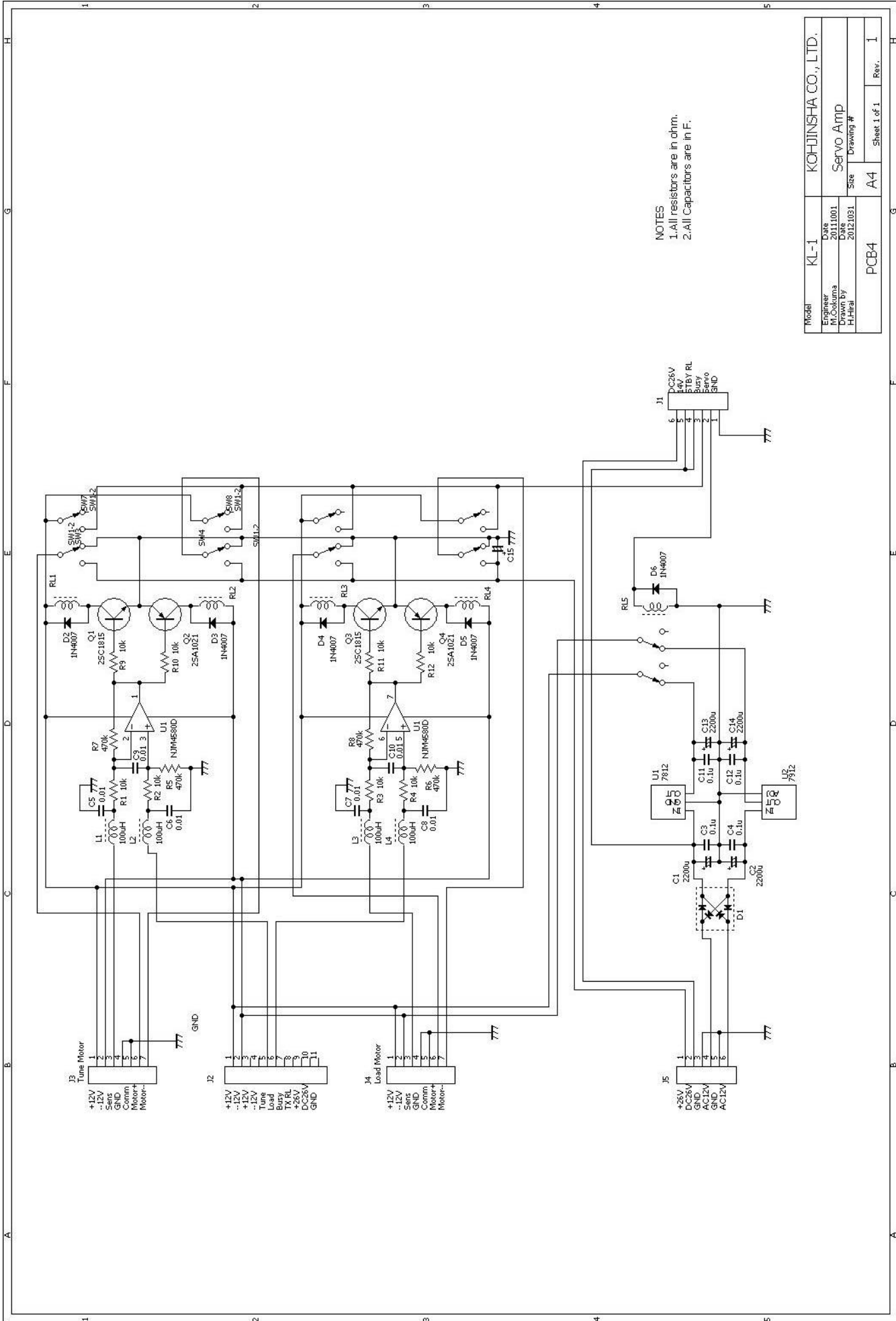

NOTES
 1. All resistors are in ohm.
 2. All capacitors are in F.

Model	KL-1	KOHJINSHA CO., LTD.	
Engineer	M. Yokuma	Date	2011/001
Drawn by	H. Hiral	Date	2012/031
Size	A4	Sheet	1 of 1
Rev.	1		

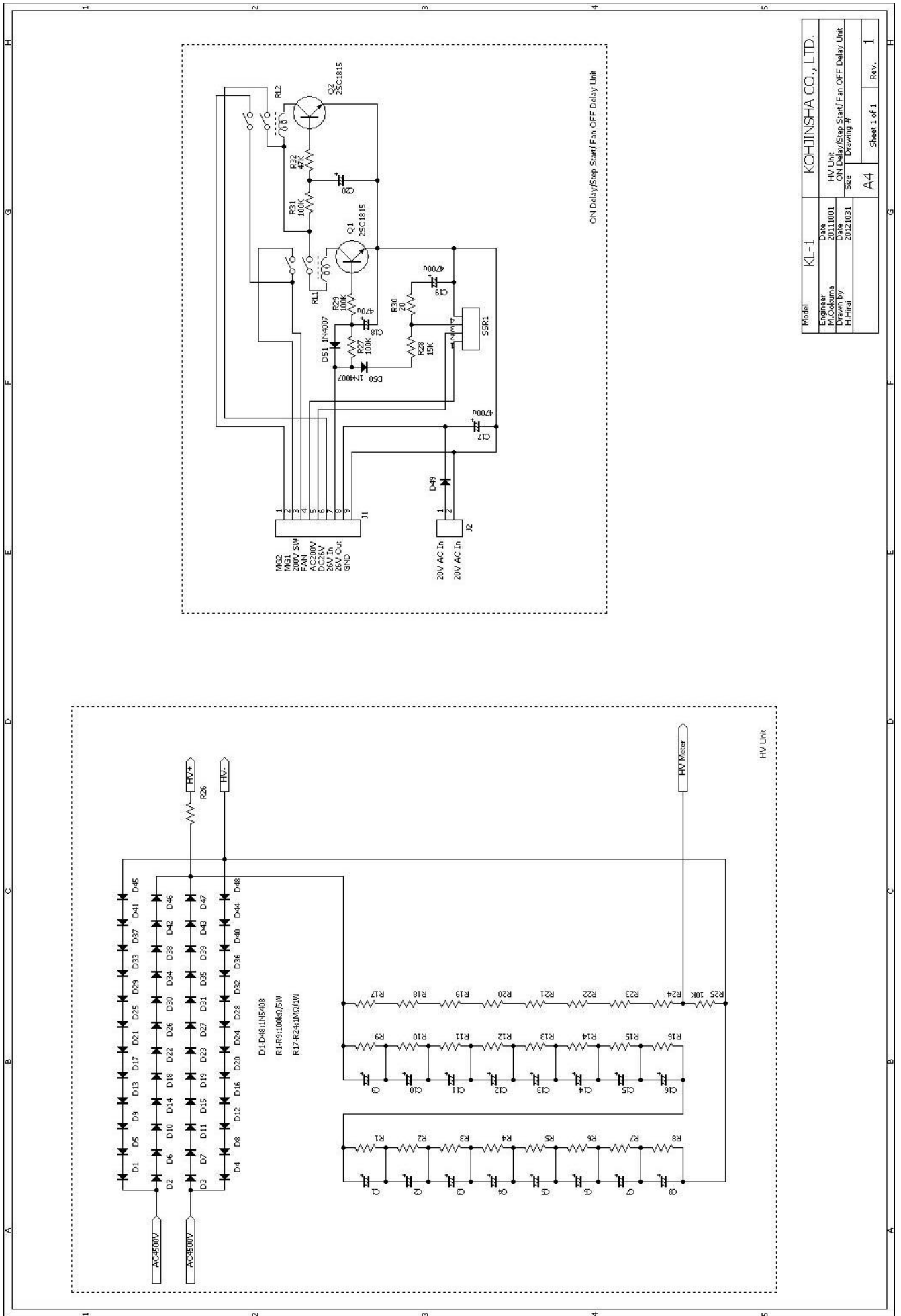

Model	KL-1	KOHJINSHA CO., LTD.
Engineer	M. Yokuma	HV Unit
Date	2011/001	ON Delay/Stop Start/Fan OFF Delay Unit
Checked by	H. Hatai	Sheet Drawing #
Date	2012/031	A4
Sheet	1 of 1	Rev. I

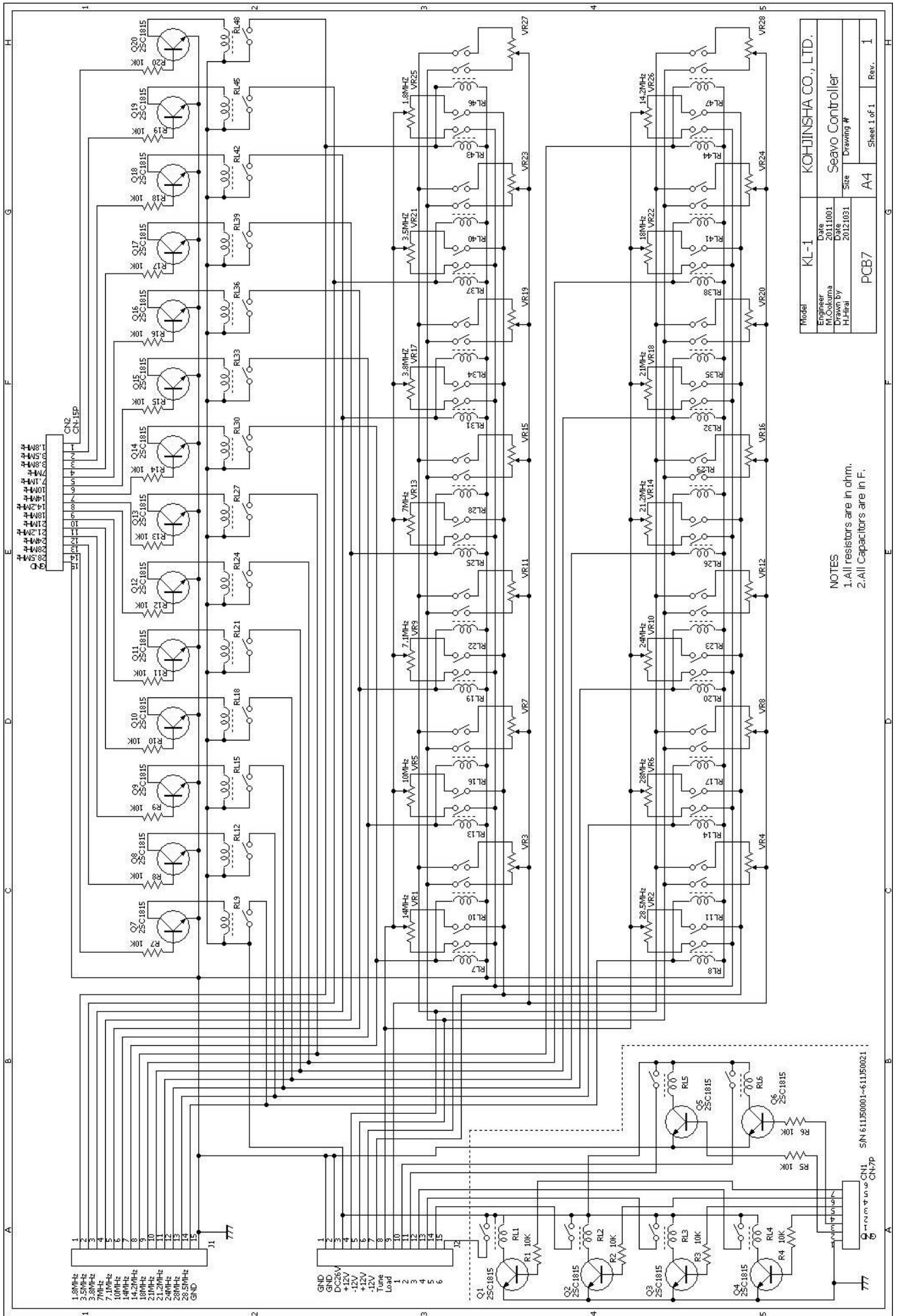

Model	KL-1	KOHJINSHA CO., LTD.
Designer	Osaka	Seavo Controller
Drawn by	M. Ohtsuka	2011001
Checked by	H. Hirai	20121031
Size	A4	Sheet 1 of 1
Drawing #	PCB7	Rev. 1

NOTES
 1. All resistors are in ohm.
 2. All Capacitors are in F.

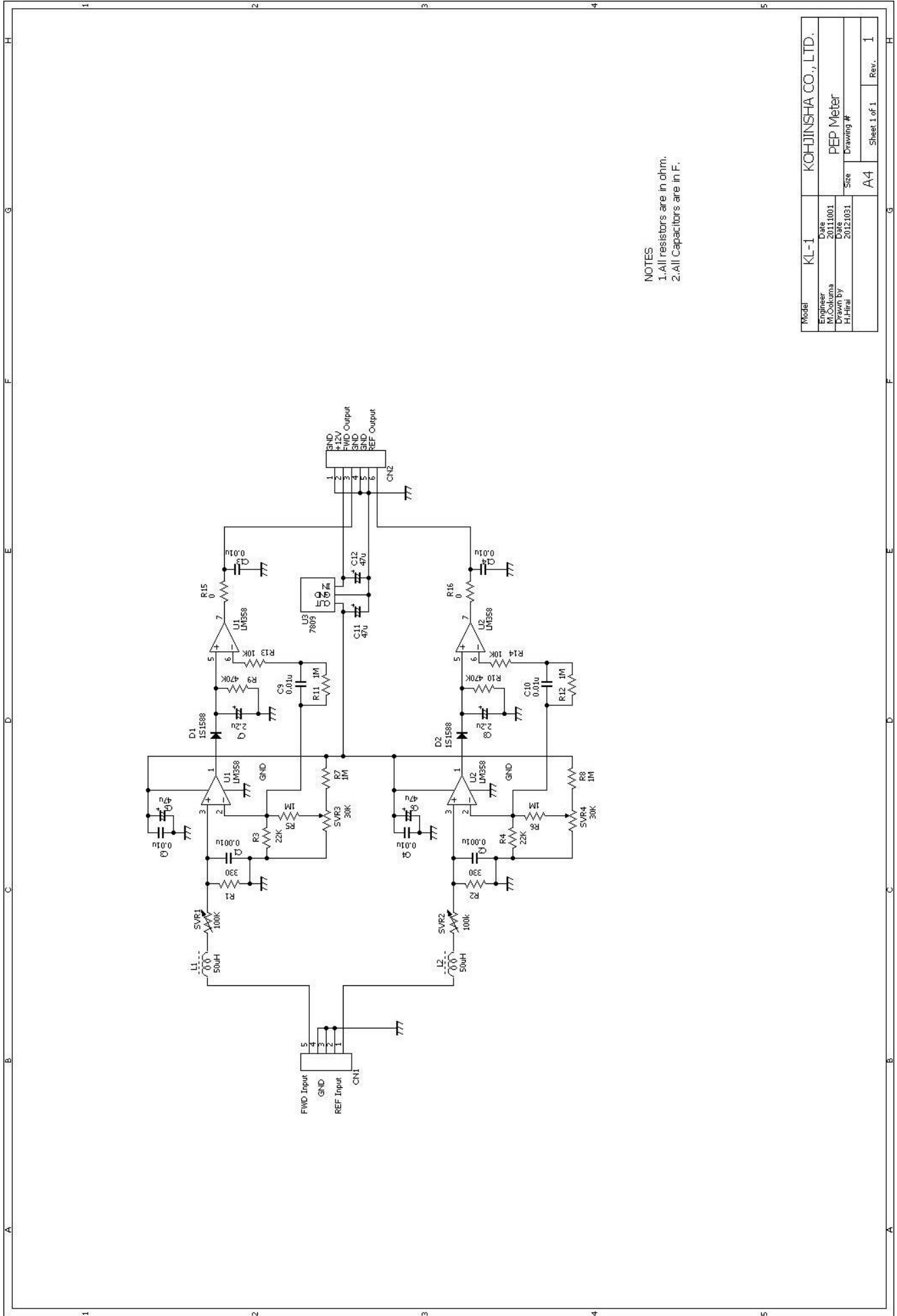

NOTES

1. All resistors are in ohm.
2. All capacitors are in F.

Model	KL-1	KOHJINSHA CO., LTD.	
Designer	OSK	Date	2011.10.01
M. Oshima		Date	2012.10.31
Drawn by	H. Hirai	Size	A4
		Drawing #	Sheet 1 of 1
			Rev. 1

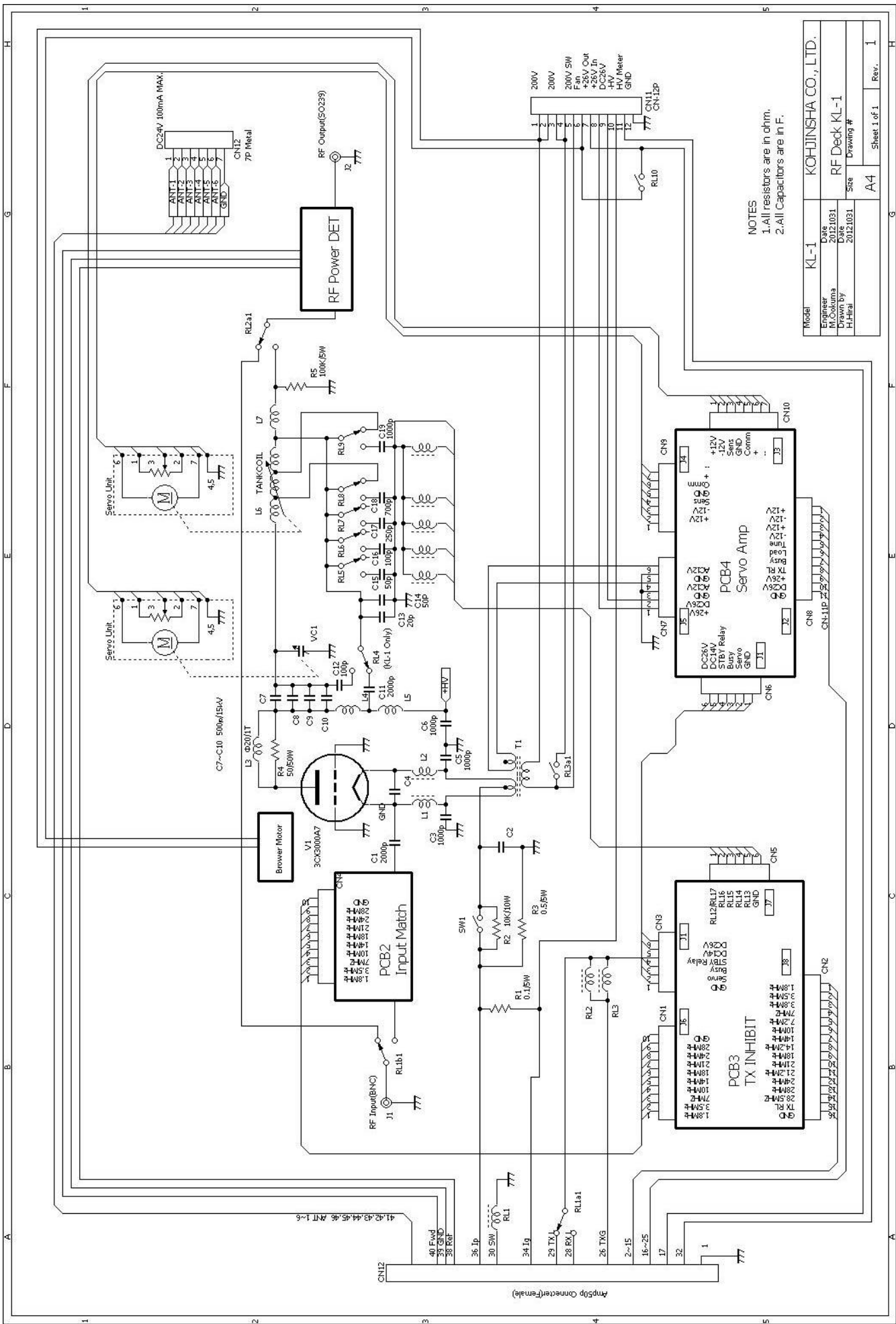

NOTES
 1. All resistors are in ohm.
 2. All capacitors are in P.

Model	KL-1	KOHJINSHA CO., LTD.
Engineer	M. Okuma	RF Deck KL-1
Date	2012/03/1	Size
Drawn by	H. Hira	Drawing #
		A4
		Sheet 1 of 1
		Rev. 1

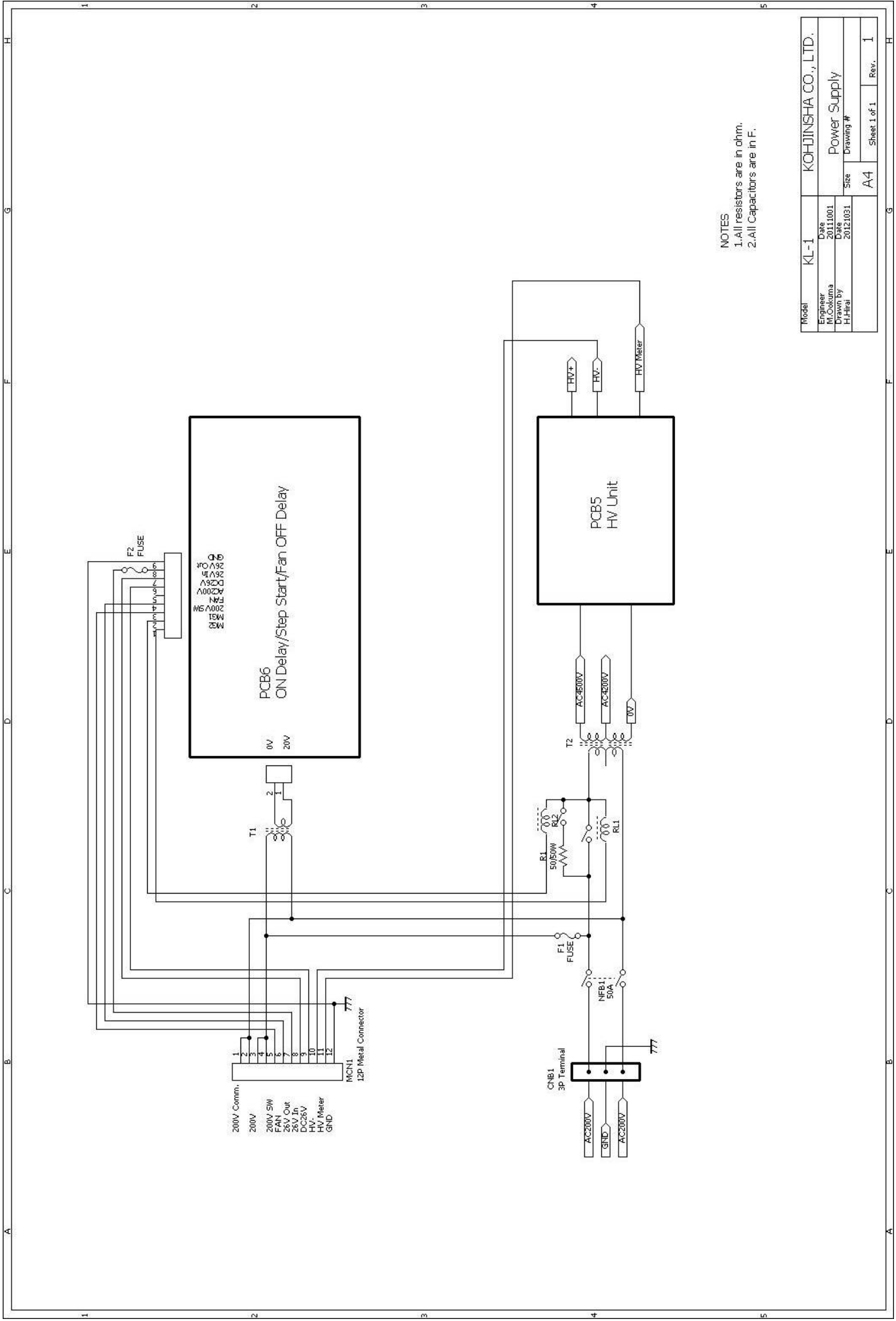

NOTES
 1.All resistors are in ohm.
 2.All Capacitors are in F.

Model	KL-1	KOHJINSHA CO., LTD.	
Engineer	M. Okuma	Date	2011/001
Drawn by	H. Imai	Date	2012/031
		Size	A4
		Sheet 1 of 1	Rev. 1
		Power Supply	
		Drawing #	

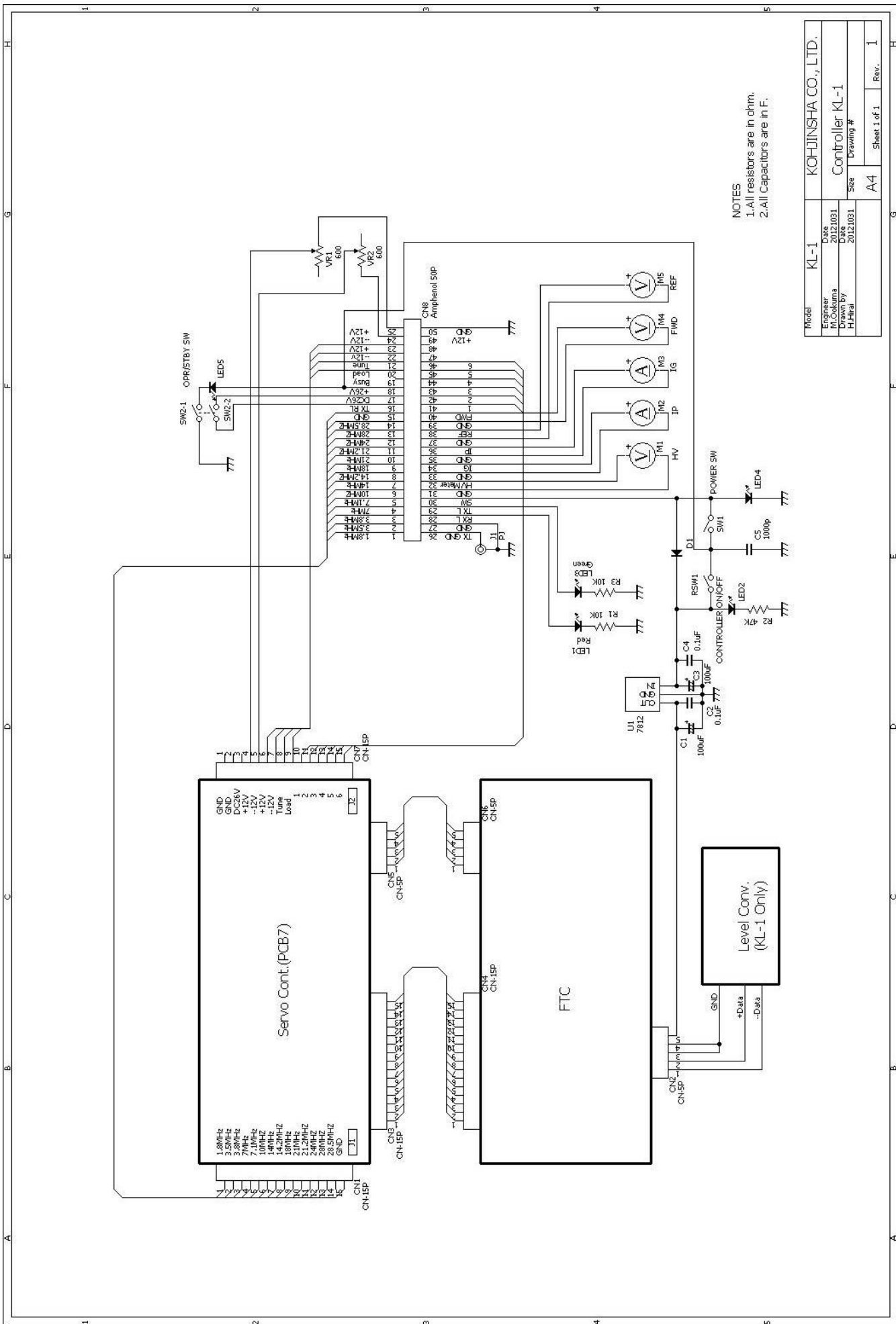

NOTES
 1. All resistors are in ohm.
 2. All Capacitors are in F.

Model	KL-1	KOHJINSHA CO., LTD.
Engineer	M. Okuma	Controller KL-1
Date	2012/03/1	Size
Drawn by	H. Hiral	Drawing #
Date	2012/03/1	A4
Sheet 1 of 1	Rev.	1

17 . Trouble Shooting

Symptom	Cause	Remedy	Ref.
Amplifier will not turn power on.	Plug or cable connection may be loose.	Check connecting point and make sure connected firmly.	P5 P9
	Remote control cable intermittent	Make sure connectors are firmly plugged into the end.	P8 P10
OPR LED will not on when PTT is pressed.	Broken or wrong wiring of TX control cable.	Check your TX control cable.	P8 P10
	Read your transceiver manual. They may have different TX control system.	Find the right place to connect that goes to GND when transmitted.	P8
No output power.	Insufficient exciter power	Adjust exciter RF POWER	
	Broken or wrong wiring of TX control cable.	Check your TX control cable.	P10
	No load to ANT connector.	Connect an antenna or a dummy load to antenna connector.	P5 P10
	The antenna is not connected to the right antenna connector number that is shown on the display.	Re-setup antenna selector setting.	P27
	No power on controller.	Press POWER button or turn CONTOROLLER switch to power on.	P6
KL-1 will not power up	Maximum exciter output power is insufficient to drive KL-1.	Change your exciter so that KL-1 gets its full performance.	
	AC line voltage goes down.	Check wiring. KL-1 requires more than AWG#8 wire.	
	KL-1 is set RF through.	Press OPERATION switch.	P6