



# OPERATOR'S MANUAL

**MODEL  
418**

## Table of Contents

<b>1. Your new 418</b>	<b>4</b>
<b>1.1. Unpacking 418</b>	<b>4</b>
<b>1.2. About this Manual</b>	<b>4</b>
<b>1.3. Accessory package</b>	<b>4</b>
<b>1.4. Connection to Antenna &amp; Power Supply</b>	<b>5</b>
<b>1.5. A word about grounding</b>	<b>5</b>
<b>1.6. Philosophy of design</b>	<b>5</b>
<b>2. 418 FRONT PANEL</b>	<b>6</b>
<b>2.1. SWITCHES</b>	<b>6</b>
<b>2.2. Band Buttons</b>	<b>6</b>
<b>2.3. Attenuator Button</b>	<b>6</b>
<b>2.4. Delay Button (DLY)</b>	<b>6</b>
<b>2.5. Delta Button</b>	<b>7</b>
<b>2.6. Leds</b>	<b>7</b>
<b>2.7. Display</b>	<b>7</b>
<b>2.8. Backlight</b>	<b>7</b>
<b>3. 418 Rear Panel</b>	<b>8</b>
<b>3.1. ACC 1</b>	<b>8</b>
<b>3.2. Power</b>	<b>9</b>
<b>3.3. Fuse</b>	<b>9</b>
<b>3.4. Antennas</b>	<b>9</b>
<b>3.5 Key In / Out</b>	<b>9</b>
<b>4. Amplifier Connections</b>	<b>10</b>
<b>4.1. 418 to 539 Argonaut VI</b>	<b>10</b>
<b>4.2. 418 to Other Rigs</b>	<b>10</b>
<b>5. Fault</b>	<b>12</b>
<b>5.1. Fault conditions</b>	<b>12</b>
<b>5.2. List of fault Examples</b>	<b>12</b>
<b>6. Specifications</b>	<b>13</b>
<b>7. Block Diagram</b>	<b>14</b>
<b>8. In Case of Difficulty</b>	<b>15</b>
<b>9. Warranty &amp; Return Policy</b>	<b>15</b>
<b>10. Addendum A (Added November 6, 2012)</b>	<b>17</b>

NOTES:

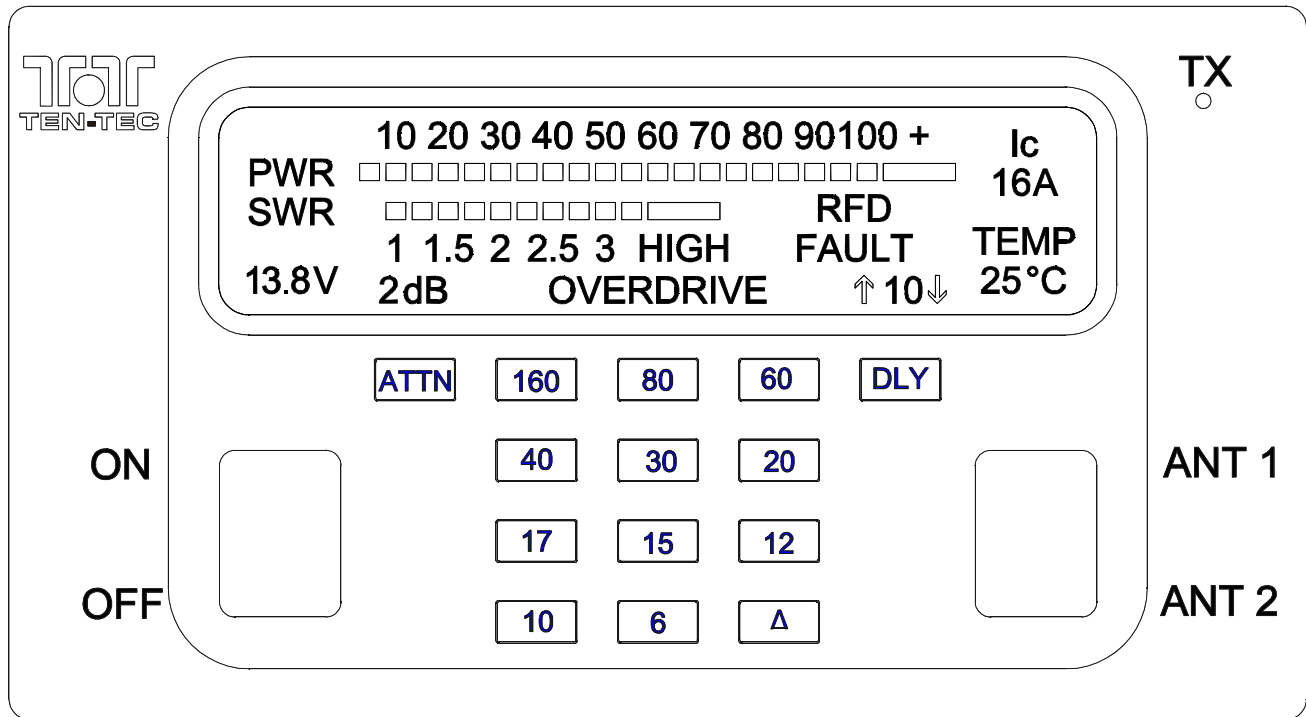

## 1. Your new 418

### 1.1. Unpacking 418

Examine the 418 for signs of shipping damage. Should any damage be apparent, notify the delivering carrier immediately, stating the full extent of the damage. Save all damaged cartons and packing material.

**Liability for any shipping damage rests with the shipping carrier.**

### 1.2. About this Manual

A complete description of the features and functions on the 418 is included within the pages of this manual. The latest version of the 418 manual is also available for viewing at [www.tentec.com](http://www.tentec.com). You may also find a full set of schematic diagrams at this same web location.

### 1.3. Accessory package

The additional hardware and accessories listed in Fig 1.3-1 come standard with your new 418. Look over the items listed and refer to the 5 digit TENC-TEC part number and description should you find the need to replace an accessory. To purchase additional accessories and parts or to report an item missing from this list, please contact Service at TENC-TEC, INC. (865) 428-0364.

Qty	Part #	Description
1	46216	3.5mm to 2 RCA jacks cable
1	27091	Auto Style Fuse, 25 Amp 32V
1	35241	8 PIN DIN Connector
1	35263	Plug – Stereo, 3.5MM (1/8)
1	46174	8 PIN DIN TO 8 PIN DIN cable
2	41073	Fork Terminal
1	46214	Power Cable
1	74020	Warranty card
1	74468	Manual for 418
1	74450	How do I become a TENC-TEC Ambassador

Table 1.3-1 418 Packing List

## 1.4. Connection to Antenna & Power Supply

The 418 is designed for use with any antenna system providing 50 Ohm resistive impedance at the desired operating frequency. Every effort should be made to ensure the impedance of the antenna system is as close as possible to the specified 50-Ohm value. Note: The “G5RV” type antenna and some Windom’s do not provide 50-Ohm impedance on all HF Amateur bands, and an external wide-range antenna coupler may be needed with this type antenna. Any antenna to be used with the 418 must, ultimately, be fed with 50 Ohm coaxial cable.

The 418 requires a source of well-filtered and regulated DC voltage. The supply voltage on the 418 is 13.8 Vdc nominal +/- 15% to allow for mobile and battery operation. The voltage source must be capable of supplying 23 amperes continuous duty. The model 940 or 941 TEN-TEC power supplies will meet or exceed your voltage and current requirements. We recommend using the included DC power cable (P/N 46214). Use of #12 stranded wire is recommended for mobile and in home use to accommodate the required current demand during transmit.

Note: Always enable the power source first and then the amplifier. If a generator or battery connected to a charger is used to supply the DC source, always turn off the amplifier before starting or shutting off the DC source equipment. These recharging devices often generate large voltage spikes that can damage the amplifier.

## 1.5. A word about grounding

A good ground system is essential for optimum operation of any HF transmitter. The best solution is to connect all the station

equipment to a single ground connection. Information on grounding can be found in the ARRL Handbook. A good ground system can contribute to the station efficiency in a number of ways including minimizing the possibility of electrical shock, and minimizing RF currents flowing on the shield of the coax cable causing interference to electrical equipment and transceiver accessories.

## 1.6. Philosophy of design

With the Model 418, Ten-Tec has created a 100 watt solid state silicon MOSFET amplifier combining automatic or manual control for ease of operation in the 160-through 6-meter ham-band.

Refer to the Block Diagram in SECTION 7 for the following discussion. Receive signals are routed through the antenna connectors (Ant 1-2 or Ant 6) along to the antenna relays then to the T/R relays. Signals then move on to the lowpass filter board and finally the Radio connector and transceiver.

Transmit signals are applied to the Radio connector and routed to the T/R relays on the lowpass filter board and then to the input attenuator, input power bridge and frequency counter. This transmitted signal is applied to the 100 watt MOSFET amplifier and back to the lowpass filter to be applied to the correct filter and on to the antenna relays, finally moving to the antenna connector Ant 1, 2, or Ant 6.

The PIC processor in the CPU module executes firmware to perform functions such as check input power and frequency, enable bias to the MOSFET amplifier, checking SWR, current, output power and temperature based on the inputs from the front panel buttons, key in jack or data from the ACC 1 connector. Cooling is achieved with the two internal fans that are controlled by the CPU that is monitoring the temperature of the MOSFET heat sink.

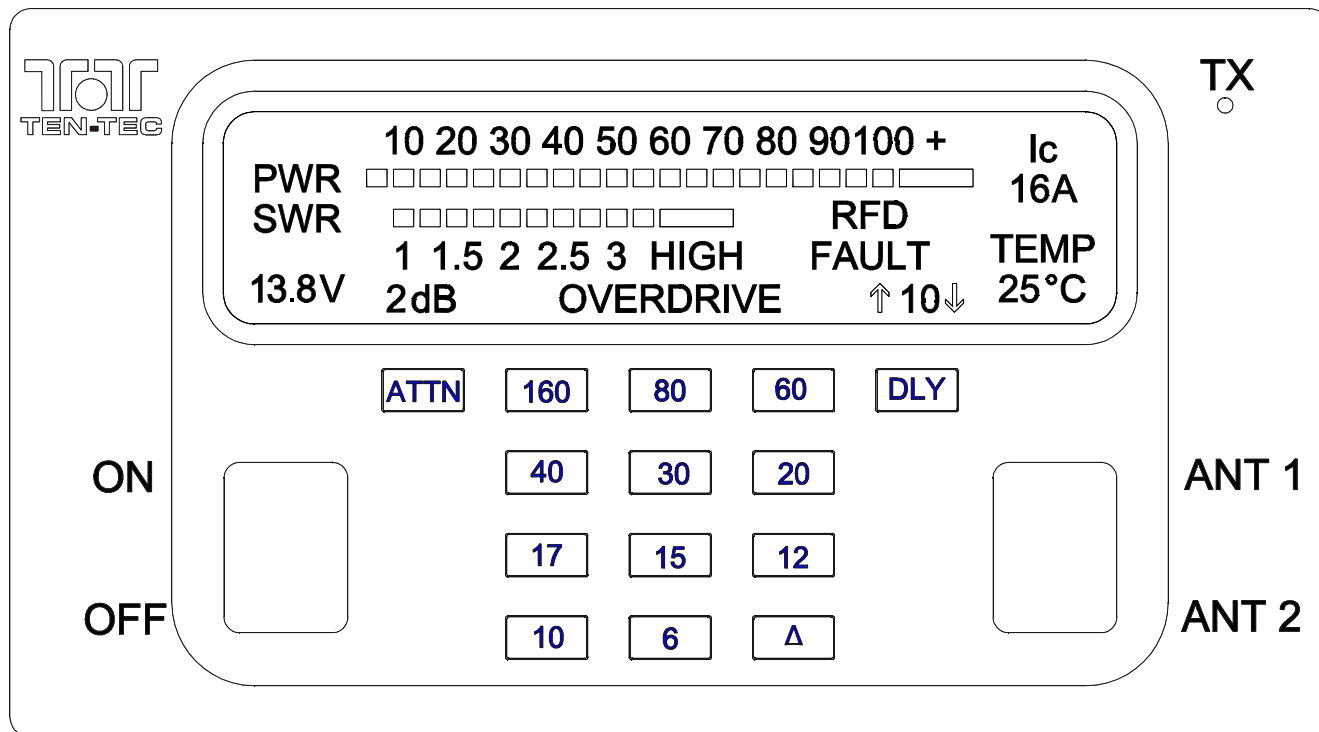

Figure 2.1 418 Front Panel

## 2. 418 FRONT PANEL

This section of your 418 Manual will discuss the front panel operations and adjustments.

### 2.1. SWITCHES

#### On Off power switch

Used to turn on the amplifier. In the off position, the amplifier is in bypass mode. In bypass the RADIO connector is connected to ANT 1 only.

#### Ant 1 Ant 2

This switch selects either Antenna 1 or Antenna 2. The 6 Meter antenna is always selected when the amplifier is on 6 Meters

### 2.2. Band Buttons

Individual band buttons are used for manual selection of one of the 11 bands. If the wrong band was selected the 418 will count the incoming RF of 200 milliwatts or more and select the correct band.

### 2.3. Attenuator Button

This button is used to reduce the input power to the amplifier when 5 watts or less can not be supplied. When selected the button will light plus show either 0,2,4 or 6 db of attenuation on the display directly above the button. To determine the value of attenuation, this formula can be used.

$(\text{Power in}) \times (\text{db multiplier}) = \text{RF to amplifier}$

db	multiplier
2	.625
4	.400
6	.250

Example Power in=20 watts attenuator = 6 db  
 $20 \times .250 = 5 \text{ watts.}$

The ATTENUATOR button can used to lower the output power of the 418 when less than 100 watt output is desired.

### 2.4. Delay Button (DLY)

The delay button delays the transmit to receive transition keeping the amplifier in transmit mode longer during cw keying. The amount of delay can be seen directly above the DLY button on the display. Each press of

the DLY button will increase the delay. To decrease delay press and hold DLY button for 3 seconds. The up arrow will turn off and the down arrow will turn on. Pressing of the DLY button will now decrease the delay.

## **2.5. Delta Button**

When the delta button is pressed and lit the amplifier looks for data coming in on the ACC 1 connector for band selection. If there is no data the amplifier will remain on the band selected.

## **2.6. Leds**

The TX led will light to show when the amplifier is in transmit mode. Another led mounted in the logo will light when the output power reaches approximately 80 watts.

## **2.7. Display**

Visible on the display is a 10 to 100 watt bar graph for forward power, and a 1 to 3 SWR bar graph. The forward bar graph features a hanging peak dot to indicate peak output power. Also above the 100 watt indicator is a long bar with a + sign. This is to let the operator know the output power is above 100 watts. Ic refers to the current of the Mosfet finals. TEMP refers to the temperature of the heat sink. Not always seen are the words OVERDRIVE, and FAULT. More on this in section 5.

## **2.8. Backlight**

The LCD has 6 leds to backlight the display, 2 red, 2 blue, and 2 green. To change the backlight, press and hold the 80 Meter band button until multiple band buttons light.

Pressing the 160 Meter button will increase the red intensity, pressing the 40 Meter button will decrease the red intensity. Pressing the 80 Meter button will increase the blue intensity, and pressing the 30 Meter will decrease the blue intensity. Pressing the 60 Meter button will increase the green intensity, and pressing the 20 Meter button will decrease the green intensity. After setting the color and brightness, pressing the DELTA button will save these setting and put the 418 in normal operation mode.

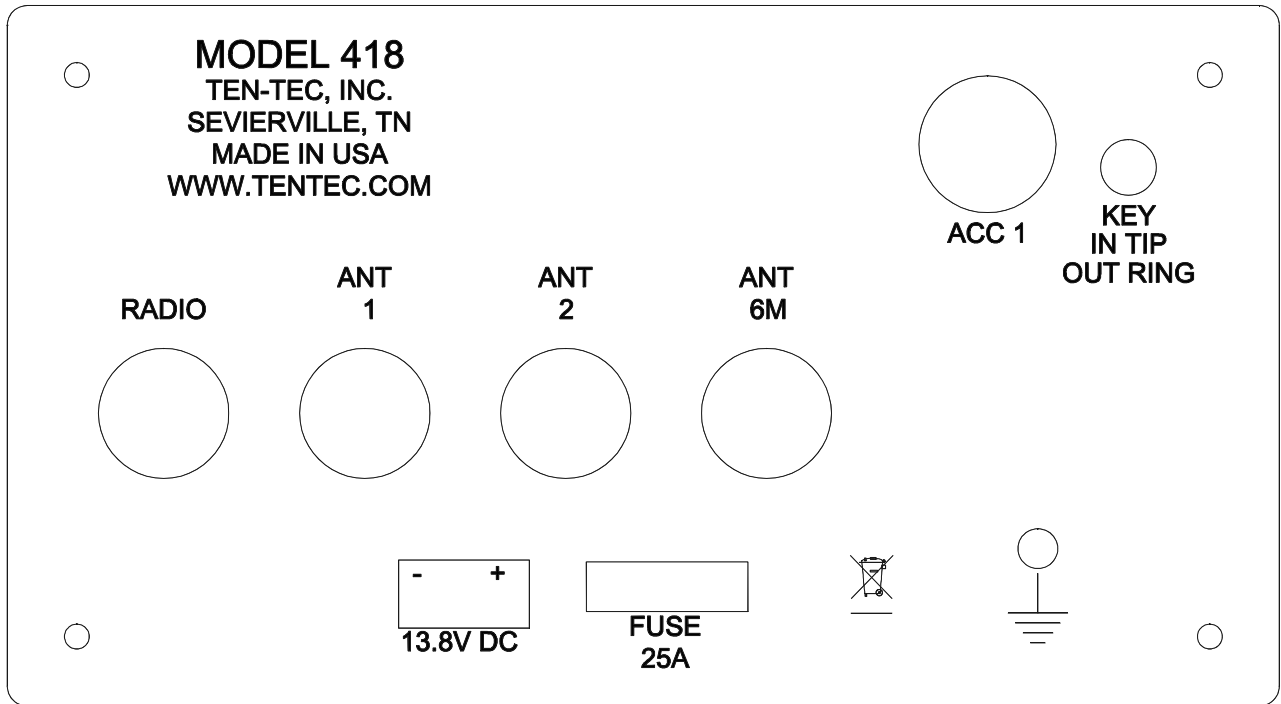

### 3. 418 Rear Panel

#### 3.1. ACC 1

The 418 is equipped with an 8 pin accessory connector. Refer to following figure for the pin definitions as viewed from the rear of the amplifier.

The pin out and function are listed in the following table.

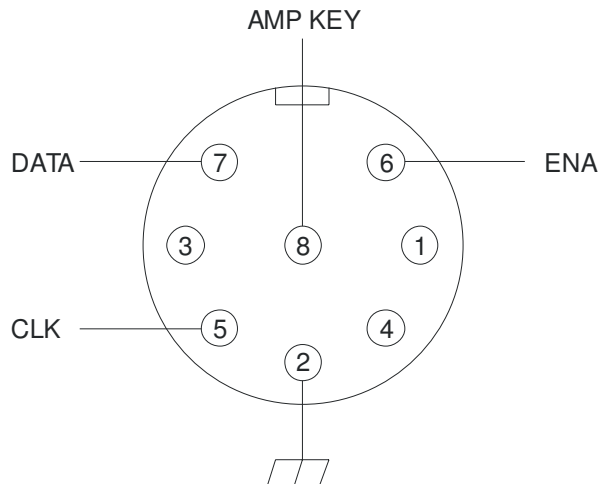

Pin	Name / Direction	Usage
1	Not used	
2	Ground	Grounding
3	Not used	
4	Not used	
5	Clock / Input	For use with 539
6	Enable / Input	For use with 539
7	Data / Input	For use with 539
8	Amp Key	Used to key the Amplifier.

Table 3-1 ACC1 Pin out

Figure 3-1 ACC1 Pin out



### 3.2. Power

Anderson Power Pole connectors are used for the 13.8VDC nominal +/- 15% input. These connectors are rated for 30 Amps each. The voltage source must be capable of supplying 23 amperes continuous duty

### 3.3. Fuse

The fuse is an auto style 25amp.

### 3.4. Antennas

There are 4 SO239 connectors on the rear of the 418. The 1<sup>st</sup>, labeled RADIO is the RF input connection from the transceiver.

HF ANT 1 and HF ANT 2 are the HF antenna connections selectable from the front panel switch. 6M ANT connector is always selected when 6 Meters is selected on the front panel.

### 3.5 Key In / Out

The rear panel on the 418 has a 1/8" stereo jack for connection of a key input and key output. The tip is used as the key input to key the 418 and the ring is used as a key out for other configurations. The key out has a 4 millisecond delay to allow the amplifier's relays to engage to prevent hot switching. The key out is not a relay. It is a transistor switch rated for a maximum of 24 volts and 250 mA. Note: You can not use paddles to key this amplifier.

See Figure 3.5-1 for proper wiring. See section 4 for other connections.

1/8" stereo jack, part number 35263

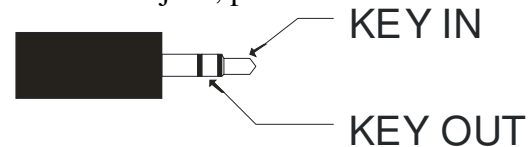

1/8" stereo to 2 RCA jack, part number 46216

#### NOTE: HOT SWITCHING

The 418 has built in hot switching protection. When the 418 is keyed and has RF output, if the key down line is then removed from the 418 the 418 will not switch back to receive until the RF has disappeared. This prevents the T/R relays from trying to switch high levels of RF.

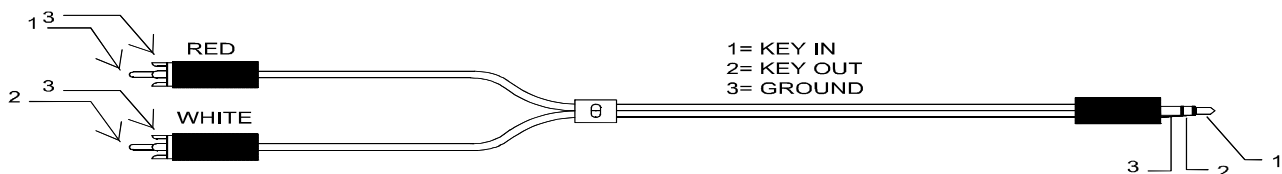
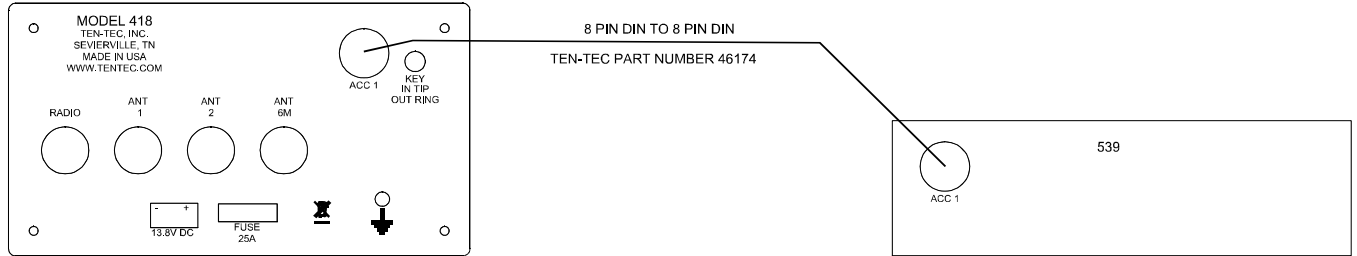

Figure 3.5-1

## 4. Amplifier Connections

### 4.1. 418 to 539 Argonaut VI

The 418 can be interfaced to the 539 using only the 8 pin din cable. The 539 will control band changes and keying the amplifier



### 4.2. 418 to Other Rigs

The 1/8" key jack provides a key input on the tip and a key output on the ring to allow the 418 to key other transceivers. Some methods are shown below.

#### SSB OPERATION

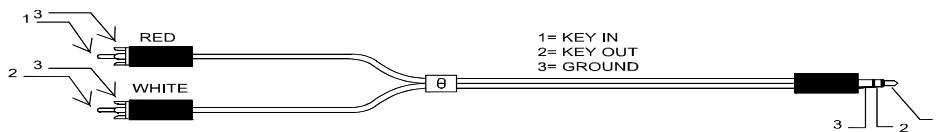
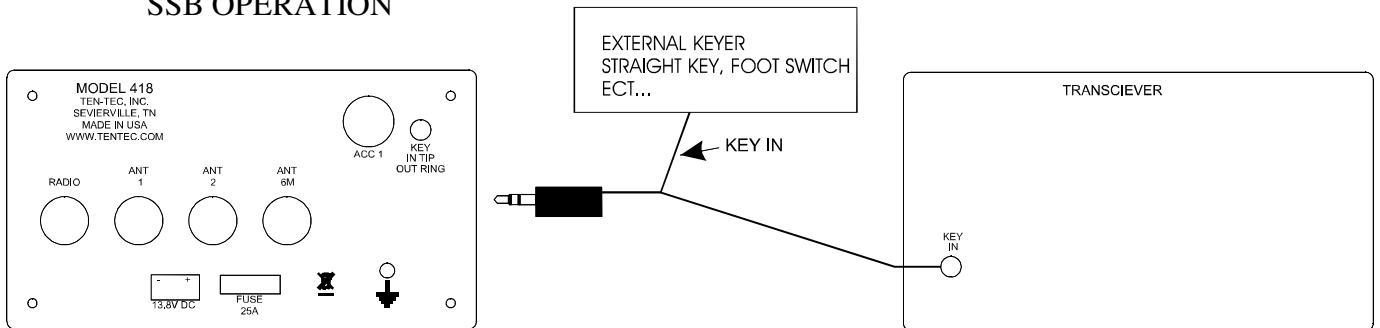

Cable number 46216

## CW AND SSB OPERATION

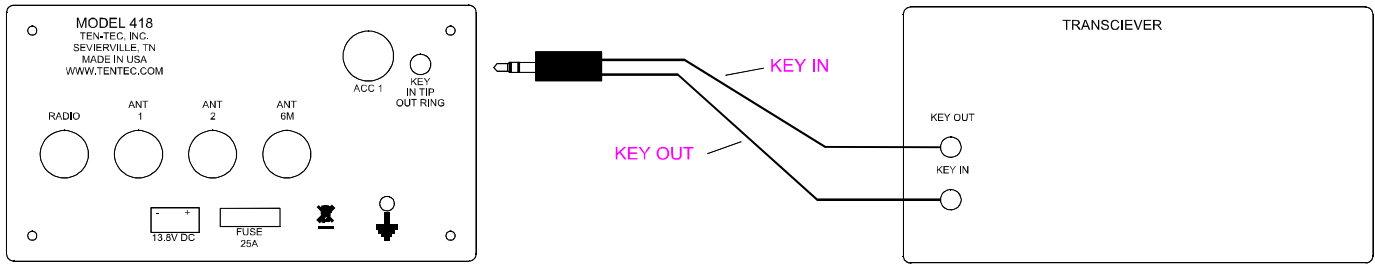

## CW OPERATION

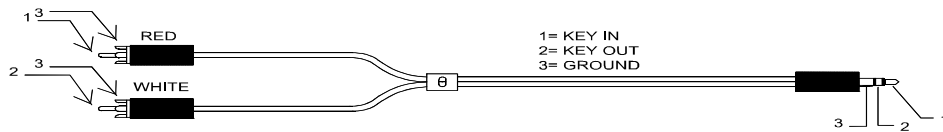
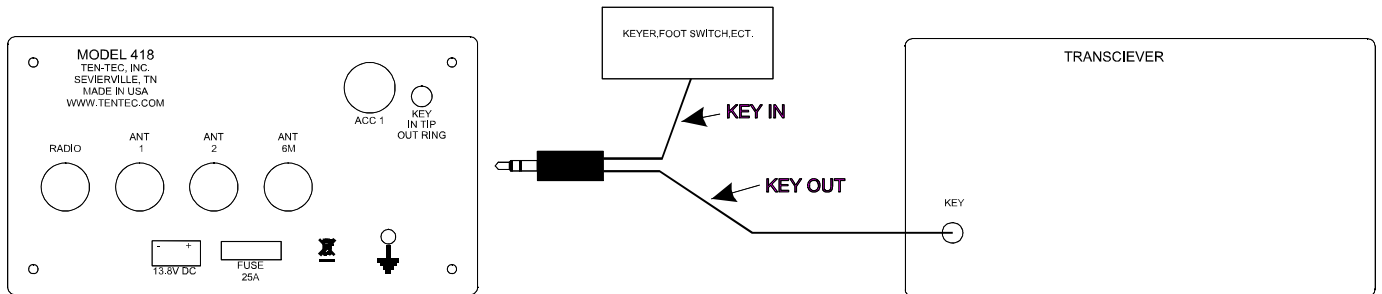

Cable number 46216

## KEYING FROM ACC1

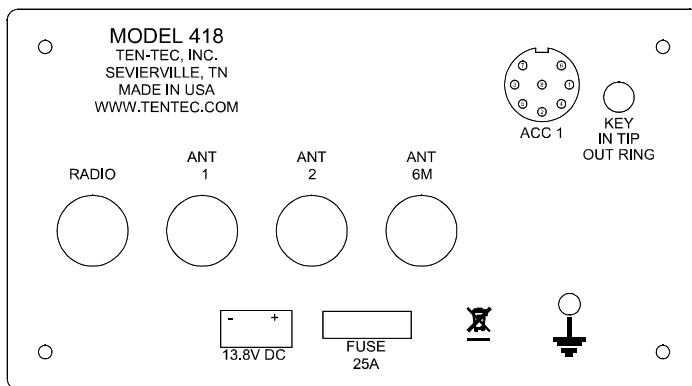

CLOSURE FROM PIN 8 TO GROUND WILL KEY 418

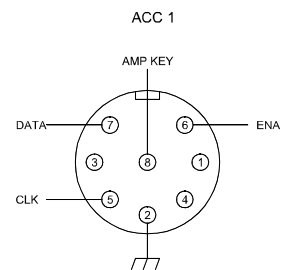
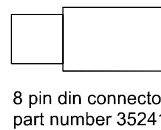

## 5. Fault

### 5.1. Fault conditions

When a fault condition occurs the 418 will go into bypass mode and display the word FAULT and what problem was found on the display. To recover from a fault condition, press any key on the front panel. The only fault that this will not reset is a Ic FAULT. To correct this problem cycle the power switch on the 418 off and on. The SWR FAULT will only happen when the output power is over 50 watts. An automatic antenna tuner can be tuned at power levels less than 50 watts without getting an SWR FAULT. If all band buttons are flashing in transmit with no output power, the 418 is trying to be operated outside of the ham bands. To correct tune inside of the ham band on radio and press one of the band buttons on the 418. For unusual problems a master reset can be done. Press and hold the ATTN button and turn on power, release the ATTN button.

### 5.2. List of fault Examples

DISPLAY	condition
FAULT Ic	>30 amps
FAULT TEMP	> 85 degree C
FAULT OVERDRIVE	>10 watt in
FAULT OVERDRIVE PWR	>115 watts out
FAULT SWR HIGH	>3.5:1 swr

## 6. Specifications

<b>Key Jack:</b>	1/8 " Stereo Tip-Key in Ring- Key out
<b>ACC Din Connector:</b>	8 PIN DIN Connector – Aux Key,Clock/Data/ Enable, Ground
<b>DC Power Connector:</b>	Power Poles
<b>Fuse:</b>	Automotive Blade Style Fuse, 25 Amp 32V
<b>Frequency Range:</b>	160-6 meters. Specifications apply within Amateur Radio bands only.
<b>Antenna Impedance:</b>	50 ohms nominal.
<b>Antenna Connectors:</b>	4 x SO-239
<b>Supply Voltage Range:</b>	13.8V +/-15%
<b>Operating Temp. Range:</b>	0-50 degrees Celsius
<b>Dimensions (HxWxD):</b>	3.625" x 6.5" x 7.6" (excluding feet and connectors)
<b>Weight:</b>	5.4 lbs
<b>Construction:</b>	Molded plastic bezel, aluminum chassis, front and rear panels and texture painted steel covers
<b>Display:</b>	Custom FSTN monochrome LCD
<b>Display Backlight:</b>	6 LEDS
<b>RF Power Output:</b>	100 W, +/- 1 dB
<b>CW &amp; SSB Duty Cycle:</b>	continuous service @ 100W

**AM,FM,AFSK,PSK Duty Cycle:**continuous  
service @100W,  
50% duty cycle  
(Tx/Rx)

**Cooling:** 2 internal fans  
temperature  
controlled

**Harmonic & Spurious Outputs:**  
-50dBc typical@100 W HF  
>-60dB @ 6 METERS

**Current Drain:** transmit 17 amps

**Third Order Intermod:** 30dB below peak

All measurements are typical. Results will vary based on different Test Environment, Tools, and Test Methods. Specifications are subject to change.

# 7. Block Diagram

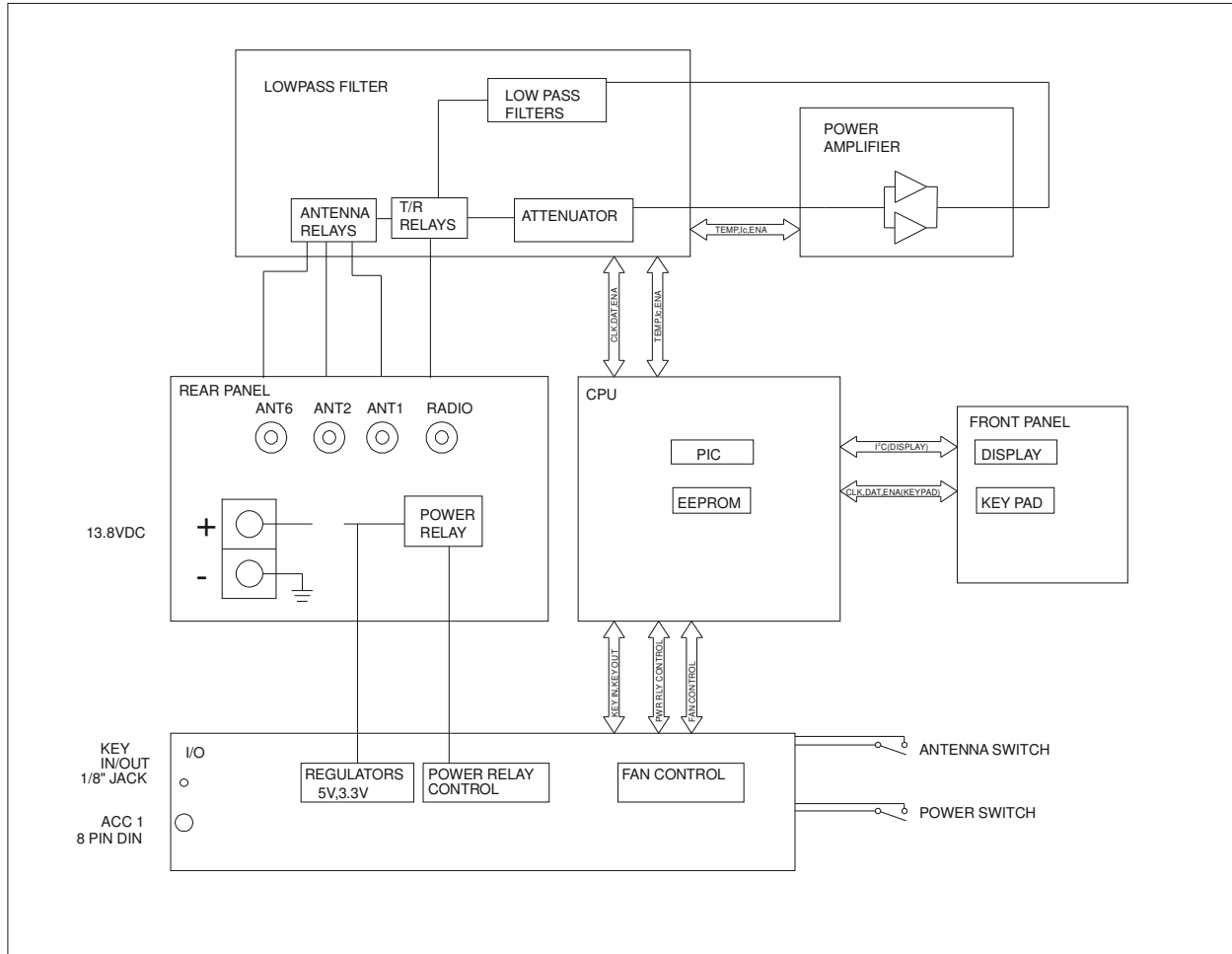

## 8. In Case of Difficulty

While we cannot cover every possible problem, here are some hints for dealing with some potential difficulties. Check the obvious. Is your DC power source stable? Check power supply, all the cable and look for loose connector(s). Is the 25 ampere fuse loose or missing? Antenna problems? Try a dummy load. Is a proper antenna connected? Is there an external antenna switch connected and properly set?

### **Problem: Distorted SSB transmit – or – Perceived RFI in the shack.**

The ALC LED should flash on voice peaks, but not remain continuously lit in SSB modes. A frequent cause of a distorted SSB signal is inadequate RF grounding resulting in RF feedback. Common RF grounding problems are no ground connection, or too long a lead to a good ground. Many problems relate to the lack of an RF station ground, as contrasted with a safety ground connection. We recommend bonding all equipment chassis together with short heavy metal braid or strap. Make these connections from chassis ground lug to chassis ground lug and connect the last piece in the chain feeding the antenna to a good earth ground. This lead needs to be as short as possible. Lengths near  $\frac{1}{4}$  wavelength on any band used can be particularly troublesome when the far end is connected to earth. It is very important that the external power supply and the transceiver and all equipment with grounding lugs are properly grounded.

Another potential cause of distorted SSB arises when the station is in the near field of the antenna or on a second story room. This is a problem many apartment dwellers face. RF can also be induced on any unshielded wires.

### **Problem: 418 power shuts off while transmitting**

The 418 is equipped with a silicon-controlled rectifier that opens if the PA current draw exceeds an instantaneous power of

approximately 30 amps. This will shut off power to the mosfet finals. Excessive current draw can indicate a problem with excessive SWR due to antenna or feedline problems. Power to the 418 can be restored by cycling the power switch off and on or the 13.8 Vdc source off and on.

If the above do not solve your problem, please consult with our service department (865) 428-0364 or [service@tentec.com](mailto:service@tentec.com)

## 9. Warranty & Return Policy

Warranty policy for Ten-Tec products is covered on the last page of this manual.

FOR EQUIPMENT MANUFACTURED BY TEN-TEC: TEN-TEC factory built radio equipment is sold under a 30-day risk-free trial period. Any piece of equipment manufactured by TEN-TEC may be returned, undamaged, within 30 days of purchase for a full purchase price refund, less shipping charges (customer pays shipping both ways).

If you want to return a piece of equipment purchased from TEN-TEC, please call the sales department at (865) 453-7172 from 8 a.m. to 5 p.m. Eastern time, Mon-Fri and obtain a return merchandise authorization number. Calling in advance for an RMA number allows us to quickly process your return and refund once your item arrives. Ship return items with letter enclosed inside the box noting the RMA number and your name, address, and telephone number. Return items are shipped to TEN-TEC INC, 1185 Dolly Parton Pkwy, Sevierville, TN 37862 USA.

## FCC Compliance

Note: This equipment has been tested and found to comply with the limits for a Class B digital device, pursuant to part 15 of the FCC Rules. These limits are designed to provide reasonable protection against harmful interference in a residential installation. This equipment generates, uses and can radiate radio frequency energy and, if not installed and used in accordance with the instructions, may cause harmful interference to radio communications. However, there is no guarantee that interference will not occur in a particular installation. If this equipment does cause harmful interference to radio or television reception, which can be determined by turning the equipment off and on, the user is encouraged to try to correct the interference by one or more of the following measures:

- Reorient or relocate the receiving antenna.
- Increase the separation between the equipment and receiver.
- Connect the equipment into an outlet on a circuit different from that to which the receiver is connected.
- Consult TEN-TEC service for technical assistance (865) 428-0364



## 10. Addendum A (Added November 6, 2012)

A change was made to the software of the 418 to permit a customer to bypass the feature where the 418 will automatically select the 6 meter antenna, and permit it to follow the two position switch for antenna 1 vs antenna 2.

To change antenna selection for 6 meters.

Turn on the 418, press and hold button “6”.

The TX LED will flash 1 time to disable the 6 meter antenna and allow 6 meters to be on antenna 1 or 2, selected by the front panel antenna switch.

Press and hold the button “6” again, TX LED will flash 2 times. This will reset 6 meters to the 6 meter antenna.

This setting is retained through power cycles. There is no visual indicator as to which method is chosen, therefore the user needs to either remember how they have it set up when using the 418 as an amplifier, or the user should press and hold the “6” button until the appropriate number of LED flashes indicating the correct 6 meter antenna usage.

This feature is available in software version 418v1b203. This software started shipping with 418 units on November 5, 2012. The 418 does provide the capability of being upgraded to this software version. Please contact TenTec service to get instructions on how to perform this upgrade. Part of the process entails the use of a Factory Service Cable. It is imperative that once the upgrade is finished that the Factory Service Cable is disconnected prior to operating the 418 as an amplifier.

**Ten Tec, Inc.**  
**1185 Dolly Parton Parkway**  
**Sevierville, TN 37862**  
**Repair Service: (865) 428-0364**

### **LIMITED WARRANTY AND SERVICE POLICY, U.S.A. AND CANADA**

Ten Tec, Inc., warrants this product to be free from defects in material and workmanship for a period of one (1) year from the date of purchase, under these conditions:

**THIS WARRANTY APPLIES ONLY TO THE ORIGINAL OWNER.** It is important that the warranty registration card be sent to us promptly.

**READ THE MANUAL THOROUGHLY.** This warranty does not cover damage resulting from improper operation. Developing a thorough understanding of this equipment is your responsibility.

**IF TROUBLE DEVELOPS** we recommend you contact our customer service group directly at the address or phone number shown above. It has been our experience that factory direct service is expeditious and usually results in less down-time on the equipment. Some overseas dealers do offer warranty service and, of course, have our complete support.

**EQUIPMENT RETURNED TO THE FACTORY** must be properly packaged, preferably in the original shipping carton(s). You pay the freight to us and we prepay surface freight back to you. Canadian customers must have proper customs documentation sent with incoming repair equipment. Duties or fees charged to improper documenting are the responsibility of the owner of the equipment.

**EXCLUSIONS.** This warranty does not cover damage resulting from misuse, lightning, excess voltages, polarity errors or damage resulting from modifications not recommended or approved by Ten-Tec. In the event of transportation damage, a claim must be filed with the carrier. Under no circumstances is Ten-Tec liable for consequential damages to persons or property caused by the use of this equipment.

**TEN-TEC RESERVES** the right to make design changes without any obligation to modify equipment previously manufactured, or to notify owners of changes to existing equipment.

**THIS WARRANTY** is given in lieu of any other warranty, expressed or implied.

### **SERVICE OUTSIDE OF THE U.S.A. OR CANADA**

Many of our international dealers provide warranty service on the equipment they sell. Many of them also provide out of warranty service on all equipment whether they sold it or not. If your dealer does not provide service or is not conveniently located, follow the procedure outlined above. Equipment returned to us will be given the same attention as domestic customers but round-trip freight expense, customs and broker fees will be paid by you.