

By I2PKW

PKW Antenna System
Instructions manual

THF2e Warc

Beam Antenna

18-24 MHz

12-17 Meters

Ditta Martelli
Via Bellini, 9
20095 CUSANO M. (MI) ITALIA
Tel.++39.2.6196441
www.antennepkw.com
E-mail : info@antennepkw.com

Technical characteristics

Model.....	THF2e Warc
Frequency.....	18-24 MHz
SWR	1:1,1
Gain	4,5 dBd
F/rear.....	24 dB
F/back.....	15 dB
Power adm.....	2 Kw p.e.p.(1 Kw cw)
Connection.....	SO239 50 Ohm
Balun 1:1 50 Ohm.....	(optional)
Wind loading.....	100 Mph
Boom length.....	2,10 meters
Reflector length.....	7,05 meters
Diam.mast adm.....	50 mm.
Diam.elements.....	30/25/10 mm.
Alloy.....	Anticorodal
Accessory & screws.....	inox stainless
Weight.....	12 kg.

PKW Antenna System

THF2e Warc parts

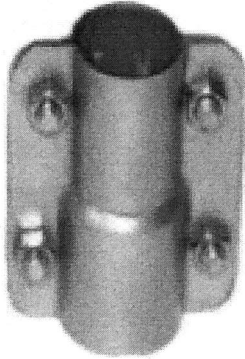

n°8 Inox clamps 30/25 mm.



n°2 Plastic supports

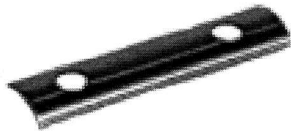

n°2 Inox piasters

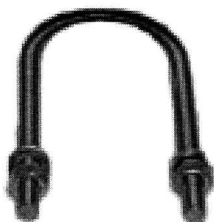

n°2 Inox U-bolt (long)

n°6 Inox U-bolt (short)

PKW Antenna System

THF2e Warc parts

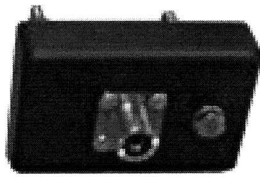

n°1 SO239 box*
*(not included, when 1:1 balun)

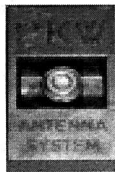

n°4 PKW clamps

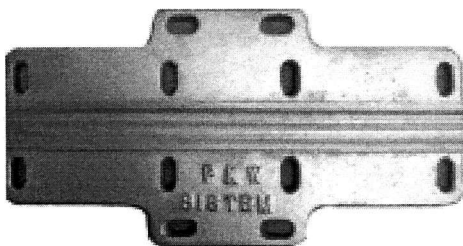

n°1 Aluminium piaster "serie corta"



n°1 Diam.50mm. boom 2,10 mt.



n°1 Diam.30mm. section 2,40 mt.



n°1 Diam.30mm. support 1,00 mt.



n°2 Diam.30mm. section 1,20 mt.



n°2 Diam.25mm. section 1,90 mt.

n°2 Diam.25mm. section 1,60 mt.

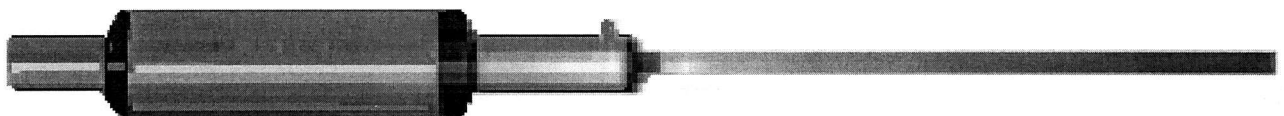

n°4 traps / terminals 10mm. included

PKW Antenna System

Boom assembly

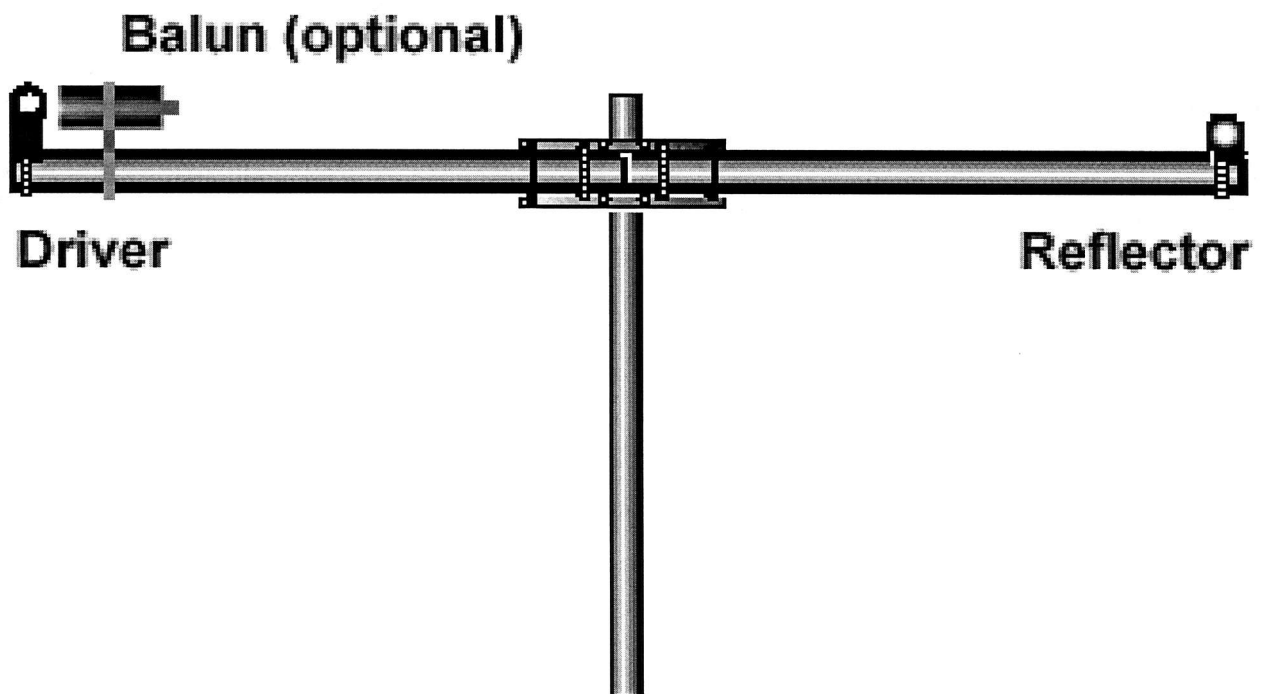
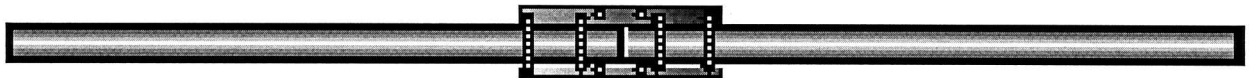
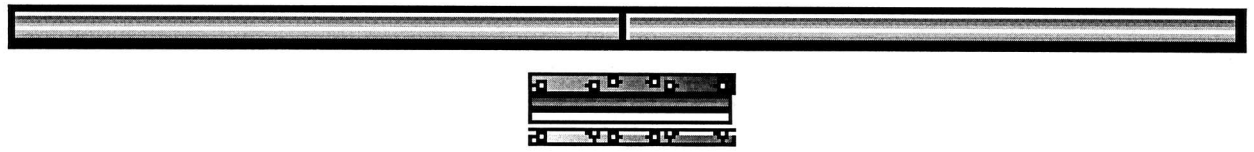

PKW Antenna System

Elements assembly

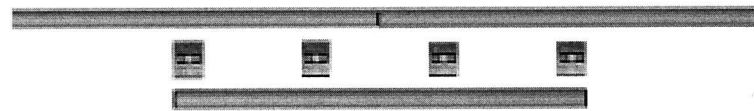

radiatore/driver

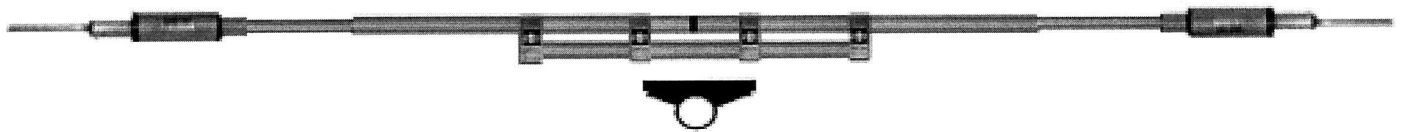

Riflettore



SWR

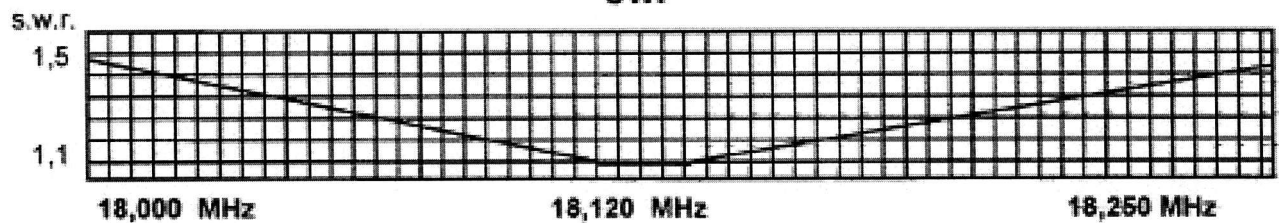

SWR

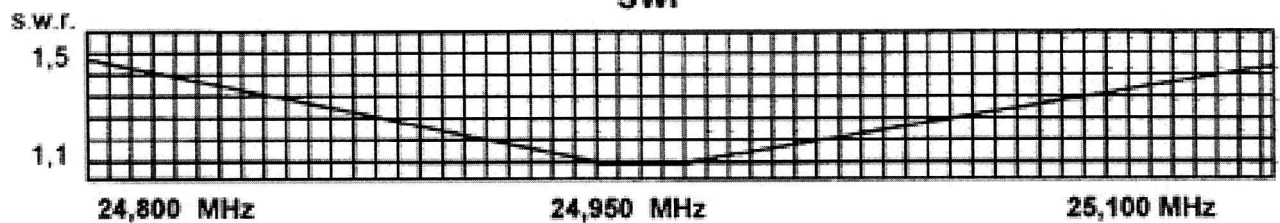

PKW Antenna System

Balun 1:1 - 50 Ohm

14-18-21-24-28 Mhz



Radiation pattern without 1:1 Balun

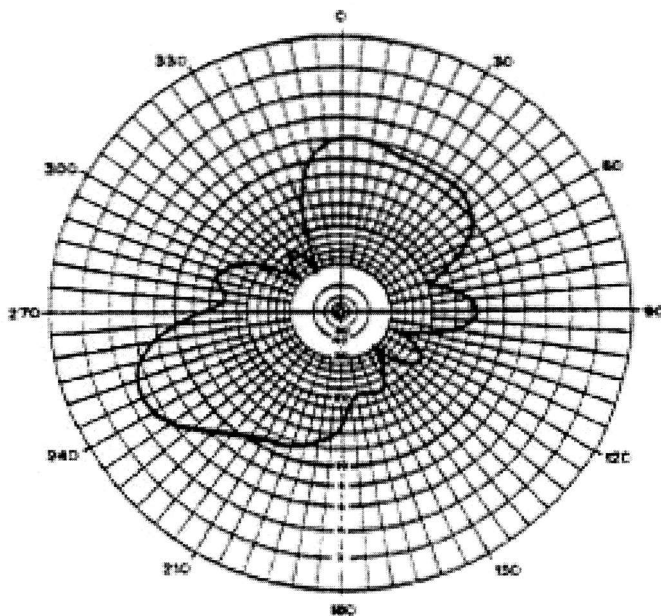

Radiation pattern with 1:1 Balun

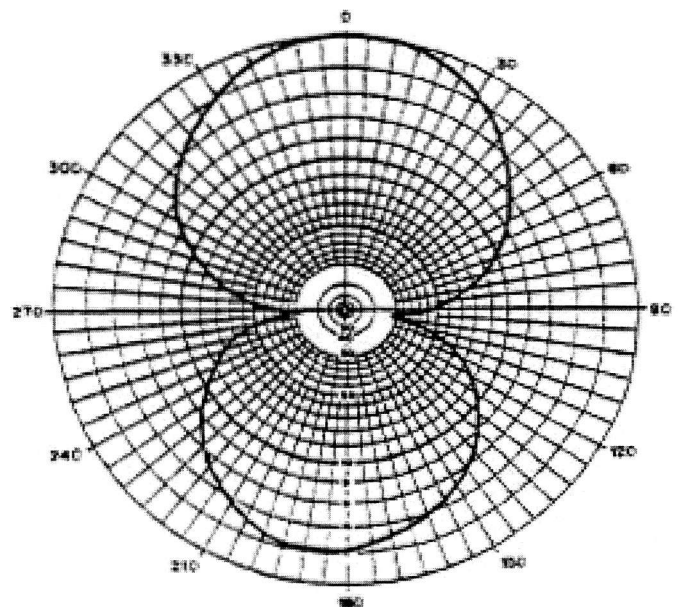

PKW Antenna System

1:1 balun assembly

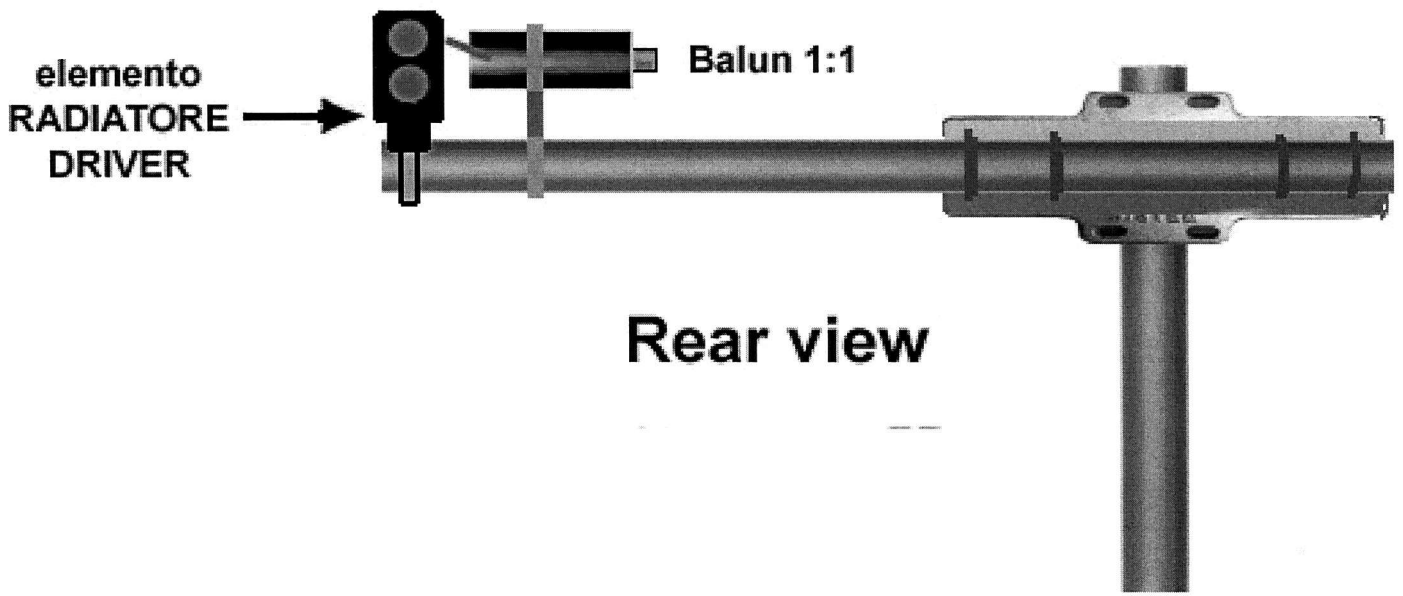
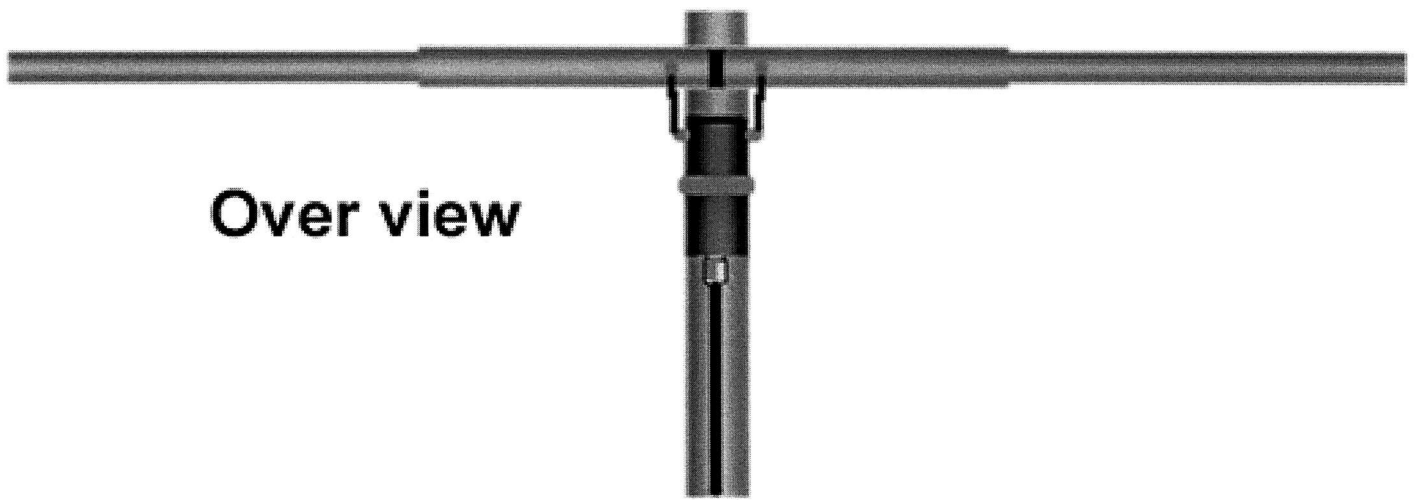

PKW Antenna System

THF2e Warc

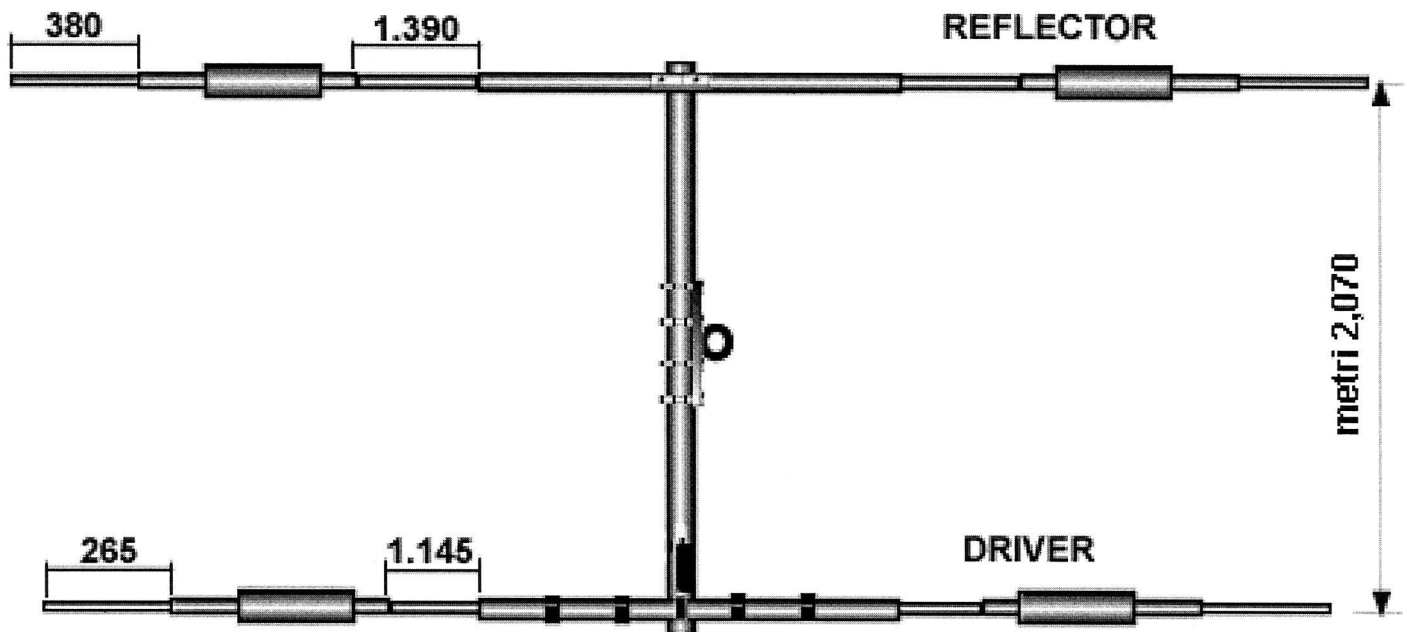

Warning!
measurement
point is at
the centre!

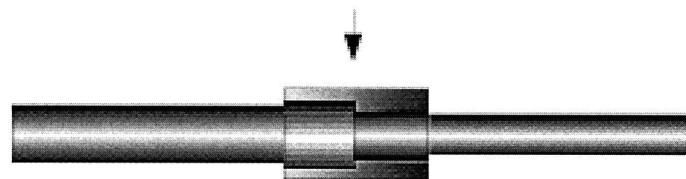

PKW Antenna System

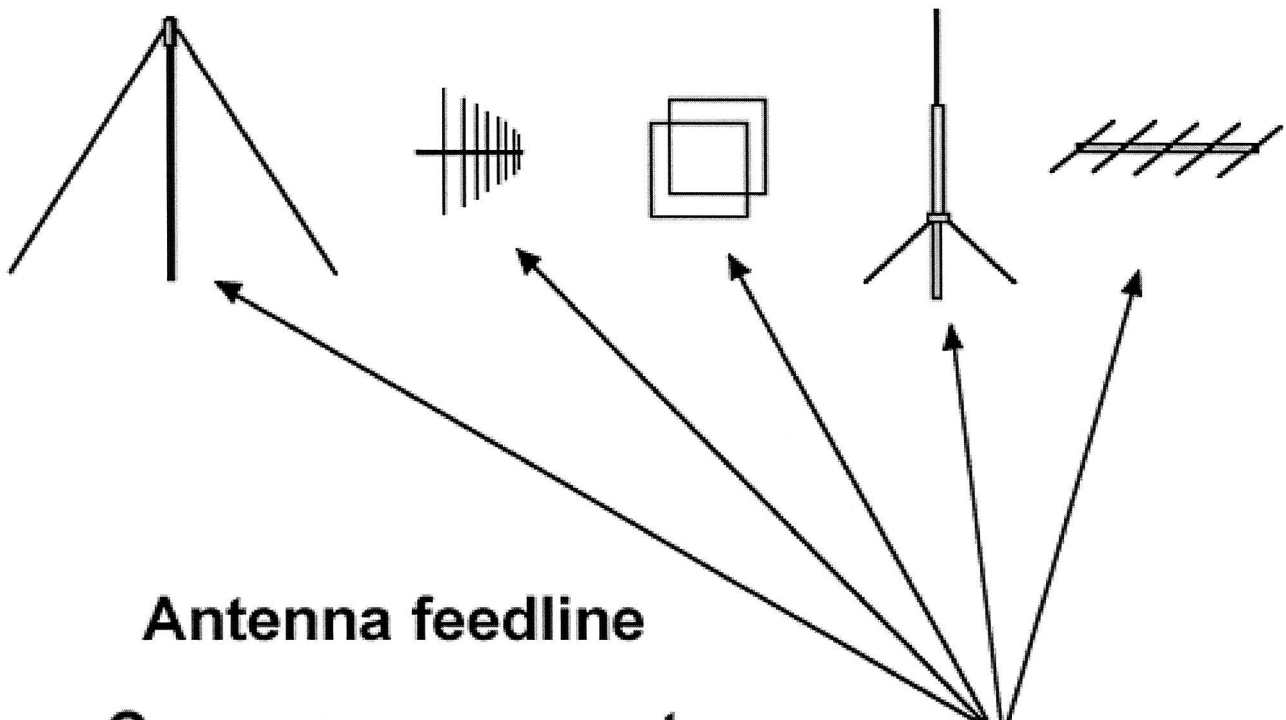

Antenna feedline

**Coax measurement
RG213/U (0,66/m)**

mt. 15,900
23,850
31,800
39,750

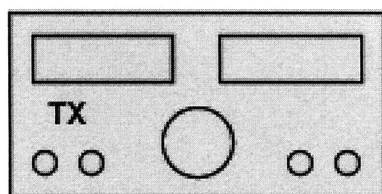
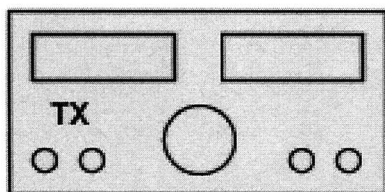

metri 1,360

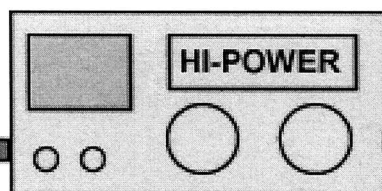

PKW Antenna System