

www.QuietRadio.co.uk

Aziloop Antenna Processor

Model DF-72



Reception. Reinvented.™

User Guide

Version 1.9.1 for Aziloop App Version 1.5.1

August 2024

Aziloop is designed and manufactured in the UK by QuietRadio

About This Document

This User Guide is intended to provide information sufficient to enable users to install, set up and use Aziloop DF-72 to best advantage.

Please get in touch if you think we have left anything out, made any mistakes, or could explain things in a better way.

We also welcome suggestions for new features or products.

Document Navigation

There is a comprehensive Contents section at the start of this document. Click on any topic to select.

Your PDF viewer should have the facility to display the Table of Contents in a sidebar for easy navigation.

Click [Contents] in the footer of any page to return to Contents.

OPERATING AZILOOP SAFELY

Aziloop is a receive-only system. Failure to observe the following instructions could seriously damage Aziloop hardware or your receiver.

- Power supply: do not exceed 13.8 V DC (+/- 5%).
-
- Do not connect Aziloop to the output of a transceiver or transmitter.
-
- Do not connect your receiver to the LCU connector on the CIU.
-
- For locations with co-sited transmitters, place the loops as far away from hot antennas as possible and make sure you use Aziloop's built-in [PTT muting](#) function, especially if you run 1 kW.

Copyright declaration.

Aziloop Hardware, Software, Firmware and Documentation is automatically protected by Copyright and Intellectual Property law.

You are licensed to use the Aziloop app for the sole purposes of controlling Aziloop hardware and attached devices or the simulation thereof in Demo mode.

Illegal use includes but is not limited to reverse engineering dis-assembling copying documenting or reselling the app or the CIU/LCU firmware or the CIU/LCU circuit in whole or in part for profit or non-profit without documented consent from QuietRadio.

QuietRadio and Aziloop are registered trademarks owned by Dave GW4GTE.

When you purchase Aziloop you are also contributing towards the cost of software development and support. The Aziloop app was written in-house from scratch, and this version is the result of several years of development, which is still ongoing.

How this User Guide is organised

Once you're all set up, the **green sections** below are your reference for day-to-day use.

Section 1 - Aziloop overview

Feature Summary, Description of component parts

Configuration hierarchy:

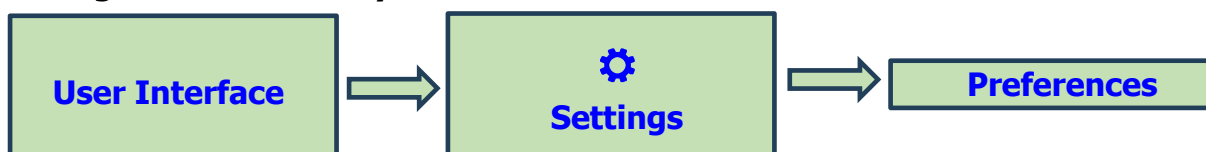

Section 2 - User Interface

How to operate Aziloop, function by function

Section 3 - Settings

Including Modes, Aux I/O and updates

Section 4 - Preferences

Including Antenna options, Omni-Rig, and Palette Editor

Section 5 – Remote Operation

Setting up and using Client and Server modes

Section 6 - Installation

Separate sections for Antenna, CIU, LCU and PC app.

Appendix 1 – Aziloop in practice

What you should expect

Appendix 2 – Understanding your Aziloop

Appreciating K9AY and Loop mode differences.

Contents	
1.0 OVERVIEW	14
1.1 DF-72 Feature Summary	15
Dual Mode – Loop and K9AY	15
Stepped-Azimuth™	15
Intuitive UI (User Interface)	15
Remote Operation	15
No Control Cables	15
Designed for Outdoor Use	15
Full Control	16
Mute Facility	16
Omni-Rig 1.2 Support	16
1.2 Aziloop Components	17
1.2.1 The Antenna	17
1.2.2 The Loop Controller Unit (LCU)	17
Internal functions of the LCU	18
1.2.3 The Common Interface Unit (CIU)	18
CIU Connectors	19
Power Input (13.8 V nominal +/- 5%)	19
Current Drain	19
Status LED	19
Auxiliary I/O ports – 3.5 mm socket	19
Mini USB socket	19
PHY connector marked 'LAN 10/100'	20
LCU Connector	20
Receiver Connector	20
Internal functions of the CIU	20
1.2.4 Modes of Operation	21
1. Local mode	21
2. Local Demo mode	21
3. Client mode	21
4. Server mode	22
5. Server Demo mode	22

6. CIU Server	22
2.0 USER INTERFACE (UI)	23
Mouse Buttons and Scroll Wheel	23
The Complete UI (All panels visible)	23
Menu Bar	23
The Gear Icon – for all settings	24
Starting the Aziloop app	24
LCU Power-Up	24
LCU Power-Down	25
Closing the Aziloop app completely	25
Compass panel Options	25
On-screen positioning	25
Controlling Panel Visibility	26
Panel Selector Controls	26
Showing the Title and Menu Bars	26
Showing the side panels	26
Showing the Memory Panel	27
Showing the AUX (Auxiliary I/O) Panel	27
Memory / AUX panel interaction	27
Control Workarounds	28
2.1 Antenna Control - Compass Panel	29
Overview	29
Heading pointer	30
2.1.1 Changing Modes	30
Mode Priority	30
2.1.2 Changing Headings	32
Method 1: Using the mouse scroll wheel	32
2.1.3 Mouse Wheel Scrolling with Dual Step	33
2.1.4 The two-way toggle (K9AY mode)	33
2.1.5 The three-way toggle	33
2.1.6 DF Assist Options	34
Null Axis	34
Null Axis Toggle	34
Degrees	34

Preview	34
2.2 Load Panel	35
Optimum value	35
Load end stop	35
Reverse	35
2.2.1 Compass panel Load	36
2.3 Band Panel	37
Frequency visualisation	37
20 kHz to 500 kHz low pass filter	37
20 kHz to 5.5 MHz low pass filter	37
1.7 MHz to 5.5 MHz band pass filter	38
1.7 MHz to 30 MHz high pass filter	38
Bypassing the Filters	38
2.4 Levels Panel	39
Preamplifier	39
Attenuator	39
Receiver isolating – the infinity option	39
Start / Stop or Connect / Disconnect Button.	39
2.5 Memory Panel	41
Saving to a Memory	41
Recalling a Memory	41
Memory Toggle	41
Naming a memory	42
Aux I/O	42
Each memory also stores the Aux I/O state as long as the channel(s) are set to 'Control' in Settings>Aux.	42
The state is recalled as long as Pref 1>Memories> AUX I/O is enabled, and the channels are set to 'Control'.	42
Why Memories?	42
2.6 Aux I/O Panel	43
Showing the Aux I/O Panel	43
AUX settings shortcut	43
3.0 SETTINGS	44

Settings Panel	44
Preferences shortcut	44
Reset Aziloop to default settings	44
3.1 Settings - Mode	45
Local mode	45
Client mode	45
Server mode	46
3.2 Settings – AUX	47
Aux channel Options	47
Electrical	48
3.2.1 PTT Mute Function	50
3.2.2 Dealing with PTT lines	53
3.3 Settings - Info	55
User Guide	55
Azi-News	55
Online alerting method to inform users of app or firmware updates, or new products.	55
Website	55
3.3.1 Code Updates	55
Updating the App	56
Uninstalling the previous app version	56
Updating the CIU Firmware	57
3.4 Settings - Preferences	59
Side-by-Side view	59
3.5 Settings - Remote Server / PC Server	59
3.6 Settings - CIU Server	60
CIU Server mode	60
CIU Server setup is discussed in detail here.	60
4.0 PREFERENCES	61
4.1 Preferences - Pref 1	61
4.2 Preferences - Antenna	63
Priority	63

DF Assist	63
Null Axis	64
Null Toggle	64
Degrees	64
Preview	64
Step	65
Dual mode	65
Antenna Alignment – hidden option	65
4.3 Preferences – Omni-Rig	66
Overview	66
Omni-Rig panel	66
Source	66
Re-naming the source	66
Omni-Rig settings	67
4.3.1 Rig Sync	67
Remote Receiver Calibration	68
4.3.2 Band Tracker	68
4.3.3 PTT Response	68
4.4 Preferences - Palette	69
Edit – Change the colours	69
Import – add more palettes	69
Export – make copies of palettes	69
Path – change the location where the palette files are kept	69
4.4.1 Palette Editor	70
4.5 Preferences – ‘...’	75
4.5.1 Azi-Auto	75
5.0 REMOTE OPERATION	77
Introduction	77
5.1 PC Server / PC Server Demo Mode	78
PC Server setup	78
Server Setup Panel	79
Multiple Address Handling	79
Server using	79

UDP Port	79
DHCP (Dynamic Host Configuration Protocol)	79
Server Polled Indication	79
5.2 Configuring the CIU Server	80
Entering the Setup panel	80
Powering up the CIU Server	81
Pinging the connection	81
Changing the settings	81
UDP Port	81
DHCP (Dynamic Host Configuration Protocol)	81
Testing	82
CIU Server Powered Advisory	82
On first powerup, if the CIU Server is enabled, an advisory panel pops up as a reminder.	82
Omni-Rig not possible via CIU Server	82
5.3 Configuring Client Mode	83
Client setup summary	83
Selecting Client mode	83
5.3.1 Server Selector Panel	84
Localhost entry on Row 1	84
Server Alias	84
IP / Domain	85
Finding a domain's IP address	85
Host (PC or CIU)	85
Status	85
Refresh button	85
Changing the UDP Port Number	86
Deleting a server	86
Leaving Edit mode	86
Client preferences	86
Auto Connect on Start	86
LCU OFF on Disconnect	86
Hide on Connect	87
Client Start Stop	87

Connect / Disconnect button	87
Exit button	87
Fully automating operation with a single Server	88
Remotely control LCU power - LCU OFF on disconnect	88
6.0 INSTALLATION	89
What's shipped in the box?	89
6.1 Installation - Software	89
6.1.1 First Installation	90
Dependencies – Windows 10 Font	91
Uninstalling the Aziloop App	92
Complete removal	92
6.1.2 Keeping up to date	93
Azi-News	93
6.1.3 Update Manager - App Updates	94
Perform the app update	94
6.2 Installation - CIU	95
6.2.1 First Installation	95
Preparation	95
Automatic COMport setup	95
Manual COMport Setup	96
In-service USB port errors	98
6.2.2 Keeping up to date	98
Azi-News	99
6.2.3 Update Manager – CIU Firmware	99
Updating the CIU Firmware	100
6.3 Installation - Antenna	102
Recommended Antenna size	103
Loop Alignment	104
The supporting Pole	104
Choose between ground or radials	105
The K9AY earth	105
The Aziloop earth method: using radials	105
Using elevated radials	105

Earth type comparison (K9AY mode)	106
Is your feeder good enough?	106
Aziloop Elevated radials 25cm agl.	Aziloop Elevated radials 2.5m agl. 108
Coax choices.	109
Attaching the loops to the pole	109
Apex suggestions	110
Tensioning the loops	112

6.4 Installation - LCU **113**

Step 1: Attaching the wires	113
Attaching the Coax.	113
Attaching the antenna cables	114
Step 2: Attaching the lid.	114
Feeder positioning	114
Static build-up prevention	115
Ferrite is good	115
Step 3: Attaching the LCU to the pole	116
LCU enclosure orientation	116

APPENDIX 1 Aziloop in Practice **117**

Your signals may vary	117
External noise limiting	117
Compatible receivers	118
Transceivers – a warning	118
Near field and far field	119
A1.1 Troubleshooting	120
Initial problems	120
Problems in-service	120
A1.2 RF Noise issues	121
Equipment noise	121
Using Aziloop to locate external RF noise	122
RFI own goals	122
A1.3 Aziloop applications	123
Direction Finding	123
Avoiding the neighbour's new toy	123

Atmospheric noise reduction	123
Resolving co-channel stations	123
NDB Listening and MW dxing.	123
Low angle DX listening	123

APPENDIX 2. Understanding your Azilooop 124

A2.1 Loop Mode	124
Azimuth plots	124
Az_1. Elevation 90 degrees	124
Az_2. Elevation 5 degrees	125
El_1. Elevation slice – On-axis	125
El_2. Elevation slice – 45 degrees off-axis	126
El_3. Elevation slice – 90 degrees off-axis	126
A2.2 K9AY Mode	127
K9AY elevation plot on-axis	127
Off-axis K9AY	127
K9AY elevation plot on-axis at higher frequencies	128
K9AY elevation off-axis at higher frequencies	128
Azimuth plots	129
The K9AY 'party trick'	130

Viewing this User Guide.

Your PDF viewer should have the facility to display the Table of Contents (as above) in a navigation sidebar.

For instance if you are using Microsoft Edge, press this:

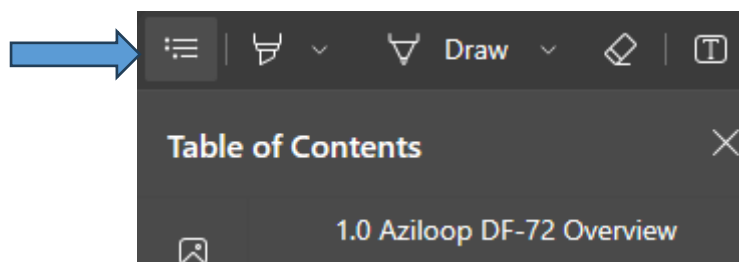

1.0 OVERVIEW

Aziloop is a dual mode electronically rotatable HF receive antenna, with a primary frequency range of 20 kHz to 10 MHz, with coverage to 30 MHz at reduced directivity and sensitivity (determined ultimately by antenna size).

Product development was started over 5 years ago by Aziloop creator Dave GW4GTE. The original requirement was for a multi-purpose antenna that could be remotely controlled. Nothing suitable existed, and so Aziloop was born.

In the DF-72 variant, Aziloop's Stepped-Azimuth™ technology offers up to 72 uni-directional headings and 36 bi-directional headings using a pair of orthogonal loops. This dual mode capability is enhanced by including features such as variable load resistance, signal level control, band filtering and auxiliary control ports as standard, all of which are managed via a user-friendly Windows app for local or remote use.

DF-72 is a significant update from the previous 24-heading DF-24 model which is now retired.

Main improvements over DF-24

- Azimuth delta refined to now provide 5-degree increments (72 headings).
- Built-in Ethernet PHY for PC-free operation (USB option retained).
- Omni-Rig 1.2 support with PTT, Aux I/O and auto filter options.
- Filters upgraded from 5 pole to 7 pole.

Who should consider Aziloop?

Aziloop will be of interest to shortwave listeners, radio amateurs, and professional users. Applications include general monitoring, co-channel station resolution, basic direction finding, atmospheric and electromagnetic interference reduction, and jamming mitigation. Plus of course just having fun learning about propagation and discovering what your previous antenna was keeping from you.

Product Positioning

Aziloop has capabilities that single loop antennas cannot offer. Occupying a different market sector, Aziloop is an intelligent first choice, or a rewarding upgrade for the discerning listener.

Professional Users

Aziloop offers a feature-set that could meet your project requirements at a fraction of the expected cost, especially tactical or SIGINT deployments. Custom builds may also be possible. Please contact us to discuss your needs.

1.1 DF-72 Feature Summary

Dual Mode – Loop and K9AY

Aziloop is unique in offering these two antenna modes in one product:

K9AY mode, where Aziloop operates as a K9AY terminated loop giving a uni-directional cardioid pattern.

Loop mode, producing the classic small loop figure-of-eight bi-directional pattern at low angles, and omni-directional pattern at higher angles.

Rapidly change mode and heading with just a mouse click.

Stepped-Azimuth™

In another first for this market, Aziloop DF-72 uses our Stepped-Azimuth™ technology to produce 72 x 5-degree uni-directional headings in K9AY mode or 36 bi-directional headings in Loop mode from a pair of orthogonal loops. The result is a choice of 108 heading/mode combinations.

To be clear, the antenna does not move, rotation is achieved electronically.

Intuitive UI (User Interface)

The antenna is controlled from a software app. Nowadays serious listeners usually employ some sort of computer based SDR receiver. Where better to control your antenna than on-screen next to your receiver display? Note: at present only Microsoft Windows 10 and 11 is supported.

Remote Operation

A remotely sited receive system is an increasingly popular pragmatic solution to local noise problems. Aziloop can be operated from anywhere there's an internet connection. Aziloop hardware is only required at the antenna (server) end.

No Control Cables

The antenna feeder also carries power and control signals to the LCU (Loop Control Unit). This makes antenna upgrades a snip if a coax feeder cable is already in place. There are other advantages too: separate control lines can be a source of unwanted noise pickup, and current loops can exist between feeder and control lines reducing antenna performance.

Designed for Outdoor Use

The LCU is housed in a high-quality purpose designed IP67 rated waterproof enclosure made from ASA (Acrylonitrile styrene acrylate) thermoplastic (as opposed

to ABS) for excellent weather and UV resistance, zero corrosion, and minimal condensation. The lid of the enclosure is secured with six stainless steel screws which clamp it firmly in place via a waterproofing gasket.

Cables are fed into the box via compression glands and are clamped using superior quality rising-cage type terminal blocks.

The enclosure includes integrated pole mounts allowing installation to be completed quickly and easily with just a couple of cable ties or jubilee clips. When you're out there fumbling about on a cold day, you'll be glad of that.

Full Control

The LCU has a switchable balanced preamplifier with a gain of nominally 18 dB, optimally placed at the antenna to maximise signal to noise ratio and swamp any external noise pickup on the feeder. Ahead of the preamp are three selectable 7-pole filters, two low-pass and one high-pass, to give your receiver (and our preamp) an easier life if needed. The high-pass filter and one low-pass filter overlap to produce a band-pass response as a fourth filter option.

The terminating resistor in K9AY mode is adjustable in 50 Ω increments from 250 Ω to 950 Ω .

The CIU (Common Interface Unit) has a 5-position attenuator: 0 dB, -6 dB, -12 dB, -18 dB and infinity (which isolates the receiver, terminating it in 50 Ω).

The combination of LCU preamp and CIU attenuator gives around 36 dB of level control allowing the user to achieve the best balance of signal to noise ratio versus dynamic range.

The CIU also has two auxiliary I/O lines that can be separately configured as inputs, or outputs. These can be operated remotely as well as locally. Uses include additional antenna switching, controlling other equipment, or in a remote scenario, mains-fail indication, intruder alarm, temperature alarm, remote fan control, equipment re-boot etc.

Mute Facility

An auxiliary I/O channel can be set up as PTT sense line to quickly isolate a connected receiver and protect the LCU from high RF levels. The second channel can be configured as another PTT input or a PTT-out line with a selectable delay. There is also a mute (talk) timer with visual display within the app.

Omni-Rig 1.2 Support

For receiver syncing, PTT sensing, Aux I/O control and auto filter insertion.

1.2 Aziloop Components

1.2.1 The Antenna



The antenna comprises two user supplied orthogonal loops identical in size sharing a common vertical axis, and four radials directly underneath forming a ground plane (or optionally an earth rod instead).

The antenna size and mounting method is a user decision therefore we don't currently offer an antenna kit, but equally we won't rule it out in future if there is sufficient demand for a complete package.

Antenna guidelines are set out in the [Antenna Installation](#) section below.

1.2.2 The Loop Controller Unit (LCU)

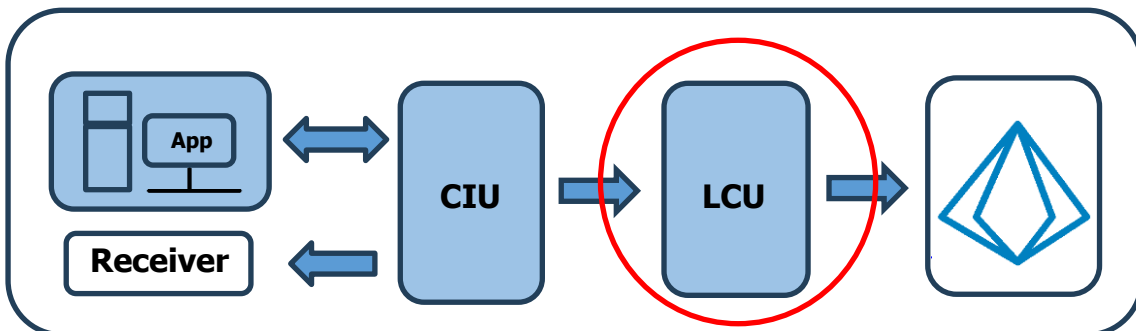

The LCU is powered and controlled via the signal coax. The connection is reverse polarity protected. Antenna wires and the feeder coax enter the LCU enclosure via compression glands. No coax plug is needed. The supplied pole mounting adapters make it easy to attach the LCU to a round pole.

Internal functions of the LCU

-Stepped-Azimuth

The Stepped-Azimuth circuit processes the incoming antenna signals to electronically synthesize a single antenna pointing in up to 72 directions, thus producing an antenna rotation capability in 5-degree steps.

-Four band filters

There are two low-pass filters and one high-pass filter. The upper low-pass filter and the high-pass filter overlap and can be enabled together to produce a band-pass filter, producing four filter options (plus of course no filter).

-Switchable Preamp

A (nominal) 18 dB gain preamplifier boosts signals to improve s/n ratio. Passive RF protection is built-in both before and after the preamp.

-Variable K9AY Load

The K9AY load resistor can be varied from 250Ω to 950Ω in 50Ω steps.

1.2.3 The Common Interface Unit (CIU)

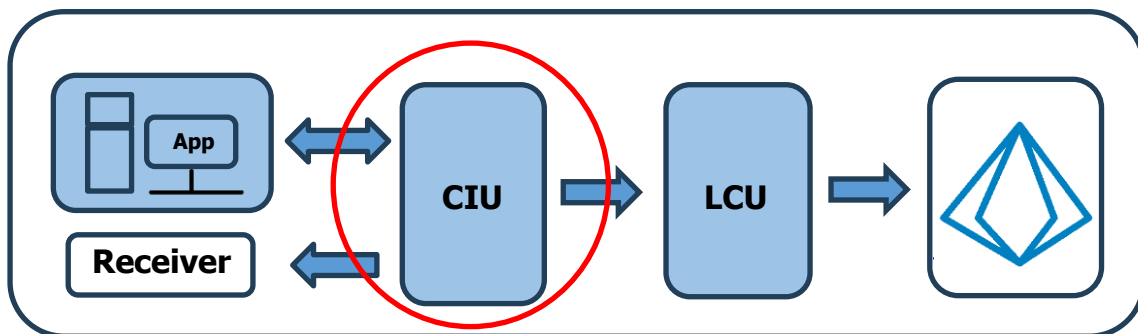

The CIU circuitry is housed in a small, extruded aluminium box. Normally mounted indoors next to your PC and receiver, it plays a central role in the Aziloop system.

CIU Connectors

Power, USB, PHY and Aux I/O connectors are all located at one end of the enclosure along with a status LED. At the other end two SMA sockets connect to the LCU and the receiver.

Power Input (13.8 V nominal +/- 5%)

A nominal 13.8 V DC is applied via the 2.1 mm barrel connector. The controller will not operate without this voltage present. The connector is reverse polarity protected. Avoid lower voltages which may cause unreliable LCU operation on long feeder runs. Higher voltages may cause overheating of components. A low noise linear power supply is recommended.

Current Drain

This is around 250 mA in normal use depending on LCU functions selected. If you are using a current-limited supply, make sure you monitor the current limiting setting. Current drain is increased by about 100 mA when the CIU Server is powered.

Status LED

On applying 13.8 V, the red LED flashes 'R' in Morse code (dit-dah-dit) indicating the internal processor is running. Following that, the LED can assume several states:

LED Off	No power to LCU
LED On	Power to LCU
LED blinks	Data being sent to LCU
LED flashes rapidly	Bootloader mode

Auxiliary I/O ports – 3.5 mm socket

There are two uncommitted I/O ports presented as a 3.5 mm stereo jack socket that can each be used as an input or an output. They can be allocated to provide a PTT (Push to talk) mute function. See the Auxiliary I/O section for full details.

Mini USB socket

Local control of the CIU using the Aziloop app is via USB. This connection is not needed when using the CIU Server once it's configured. The USB interface is powered from the USB VSYS line and is optically isolated from the rest of the CIU.

PHY connector marked 'LAN 10/100'

This is a standard RJ45 Ethernet PHY connector which will auto adjust to 10 Mbps or 100 Mbps. 10 Mbps is rarely seen these days but is more than adequate if encountered. Make sure your switch or router can rate adapt if it's 1 Gbps capable. Do not use screened RJ45 cable to avoid current loops and RF noise.

LCU Connector

The SMA female connector marked 'Antenna via LCU' feeds power and control signals to the LCU and receives RF from the LCU.

Receiver Connector

The receiver is connected to the SMA female connector marked 'Receiver'. Passive protection is built in. The port is also DC isolated.

Warning: Do not confuse with the LCU SMA connector which carries 13.8 V.

As a quick visual check, note the 13.8 V power input is on the same side of the CIU enclosure as the LCU connector carrying power.

The CIU control circuitry is powered from the 13.8 V supply. The USB interface is powered via the USB VBUS.

Internal functions of the CIU

The CIU sits where a 'bias-tee' would be located. In addition to acting as a bias-tee, the following features are included:

-Soft Start

Poorly designed bias-tees have a potential problem that could damage a connected receiver. When the DC is first applied, a situation can exist causing a voltage pulse to be applied to the receiver as the isolation capacitor charges. The CIU contains soft start circuitry that avoids this and protects your receiver.

-Opto-Isolation

To keep unwanted RF noise to a minimum, the USB interface is opto-isolated from the rest of the circuitry.

-Attenuator

The CIU contains a four-stage attenuator (0 dB to -18 dB in -6 dB steps). Additionally, there is an isolation setting that disconnects the receiver and terminates it in 50 Ω .

-Baseband filter

A permanently in-line five-pole high pass filter greatly reduces feedthrough of baseband LCU control data to the receive port. The rollover frequency is around 20 kHz.

1.2.4 Modes of Operation

Aziloop is controlled by a dedicated program (app) running under a user supplied Windows 10 or 11 PC. (Users report Windows 7 also works but it's not officially supported)

1. Local mode

This is the mode for single site operation.

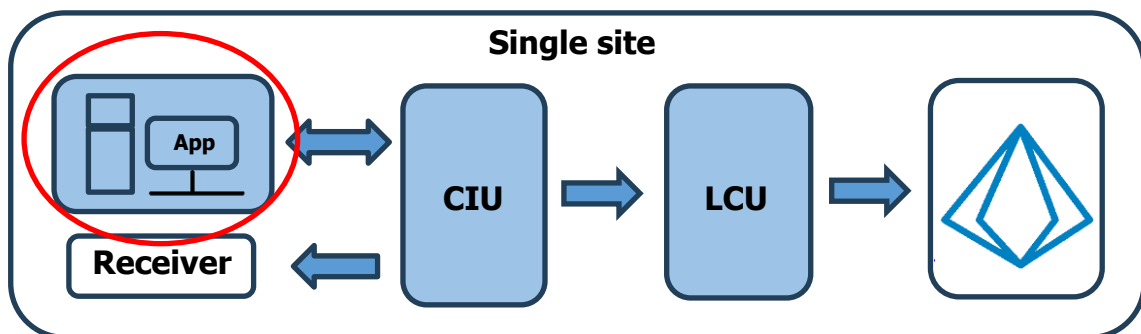

2. Local Demo mode

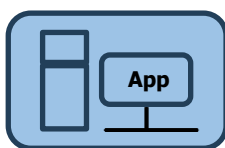

All functions are simulated within the app. No Aziloop hardware required.

Note: for all remote-control modes where the receiver is sited somewhere else, you will need to separately arrange for your receiver to also be remotely controlled, possibly using an app on the same PC the Aziloop server runs on.

3. Client mode

The user end of a client server link. No hardware is required at the client end.

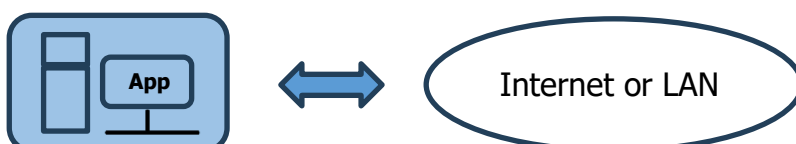

4. Server mode

App set to Server mode. The antenna end of a client server link.

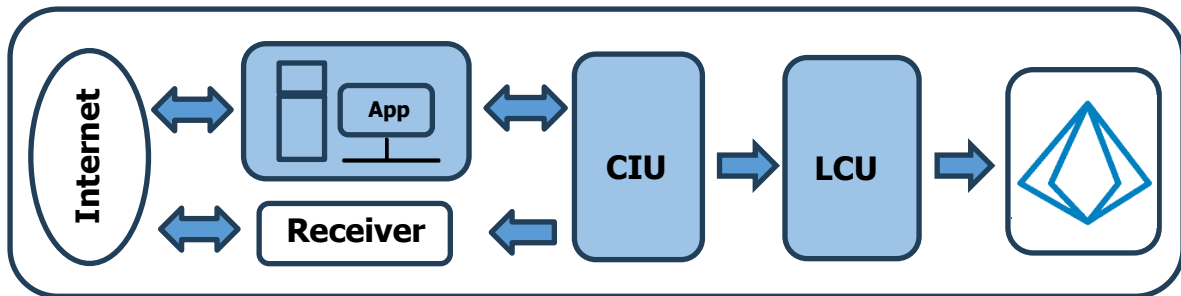

5. Server Demo mode

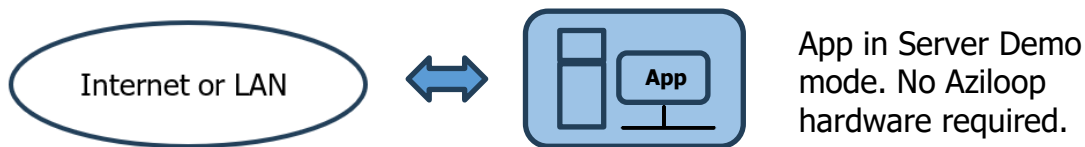

6. CIU Server

Stand-alone server using the CIU Ethernet PHY connection. It can operate alongside the app and once powered, runs independently. If you run both, be mindful of potential port conflicts etc.

The CIU, operating as a UDP Server, can be connected to a local or remote network using the Ethernet RJ45 socket.

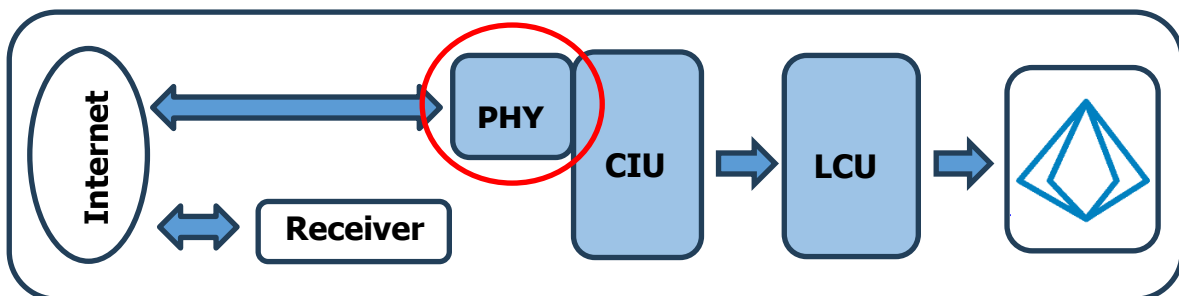

Out-of-the-box settings

IP: 192.168.1.73, Port: 8022, DHCP: Off,

Mask: 255.255.255.0, Gateway: 192.168.1.1

The CIU Server is configured via the USB interface. Once set up, the USB cable can be removed.

2.0 USER INTERFACE (UI)

From the outset, Aziloop was designed to be controlled from a computer screen, where features can be easily added that would be challenging to include later if a physical control box was used.

We have aimed to create an intuitive, clutter-free display, with a comprehensive range of settings and customisations just below the surface. You can use the ones that suit you and disregard the rest.

Mouse Buttons and Scroll Wheel

The mouse scroll wheel is the recommended way to control both the compass panel and the load panel. Use is made of both right and left mouse buttons throughout the app including control of the Compass and Load panels.

In this guide left click is written as 'click' in isolation or 'left click' if in the same paragraph as 'right click', to avoid ambiguity. Right click is always written as 'right click'.

The Complete UI (All panels visible)



The UI is divided into panels, the largest being the Compass panel. The Compass panel is the centre of operations and is always visible unless you minimise the app itself. All other panels can be hidden if preferred.

Menu Bar

The Menu Bar contains the settings gear icon and is used to display status messages e.g. "Powering Down", "Connected".

The Gear Icon – for all settings



There are several shortcuts to various settings, but all you really need to remember is that everything that is user configurable is accessible from the gear icon in the Menu Bar. Each settings option opens a new configuration panel.

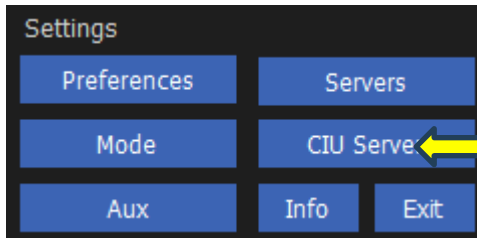

Only enabled in Client or Server modes

<Tip 1> Right click the gear icon to open the Preferences Panel directly.

<Tip 2> Right click any Preference option to open the Preferences alongside the main display rather than instead of it.

See the [Settings](#) section below for a description of all the Settings options.

Starting the Aziloop app

Start the app like any other Windows program. Unless Autostart is enabled (Preferences > Pref 1 > Start > Auto), when the app loads it is in standby mode (i.e., available but not operating. No power is applied to the LCU).

LCU Power-Up

In Local mode or PC Server mode apply power to the LCU by clicking the Power icon (lower right) or click anywhere in the circle in the Compass panel. The UI then changes to enable all controls.

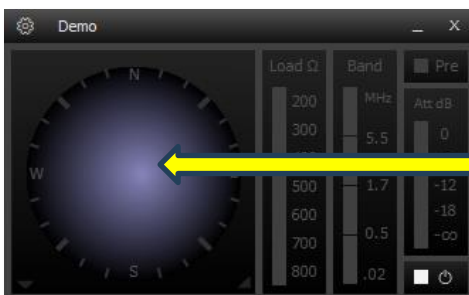

Click anywhere to power up.

Or click here.

<Tip> Remember the compass method – use this anytime, but especially to start Aziloop when the levels panel (containing the Power icon) is hidden.

LCU Power-Down

Click the Power icon to place the app into standby and remove LCU power.

<**Tip**> If the levels panel is hidden, you can use the Standby button in the options panel shown below.

Closing the Aziloop app completely

Click the 'X' button on the Title bar or Menu bar.

Note: Avoid closing down Aziloop from the Windows taskbar because Aziloop will not close gracefully using this method, and if the LCU is powered it will **stay powered** after the app is closed, with the CIU LED remaining lit.

"I've lost my Aziloop!"

If Aziloop isn't visible when the app loads, as soon as you see the Aziloop logo on the task bar become underlined, press the keyboard space bar once. This should recover the app to a centre screen position. If you've changed monitor settings, or screen resolution, or had some sort of Windows mishap (as if!) this may come in handy. Normally Aziloop should detect off-screen starts and auto-adjust.

Compass panel Options

When operating in minimum footprint mode – i.e. just the Compass panel visible, it is helpful to be able to close the app or to go standby without having to expand the UI to reveal other panels. Also, access to the Settings panel may be required. Right click the Title / Menu bar selector to reveal the Options panel.



Title / Menu Selector

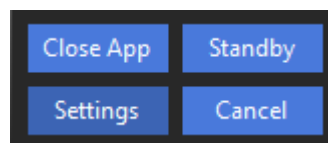

Options Panel

On-screen positioning

Mouse-drag the window via either the Title bar or the Menu bar.

Note: in the current software version to avoid losing mouse lock the Menu bar needs to be dragged more slowly than the title bar.

Aziloop can either restart centre-screen, or where you left off. See [Section 4.1](#)

Controlling Panel Visibility

Panel Selector Controls



The arrows in the compass corners are panel selector controls. Except for the Compass panel itself, all panels in the UI can be hidden or revealed by clicking these controls.

Showing the Title and Menu Bars

The top left selector controls visibility of the Title and Menu bars. Successive presses change the display between three states: both bars visible, Menu bar only and neither visible.

Showing the side panels

The top right selector controls the visibility of the three side panels. From a position of all side panels visible, successive clicks of the selector begin to collapse the side panels in a fixed sequence before finally displaying all panels once more in a round robin fashion. First the Band panel is hidden, then also the Levels panel – leaving just the Load panel, then finally all three are hidden again. Right click reverses the direction of the sequence.



Note: when the Aux panel is visible, the selector is hidden, as the full side width is needed for the Aux display

Note: When a filter segment is enabled and the Band panel is hidden, the selector becomes hollow to denote a filter is in circuit. This avoids confusing filtered signals with low band activity if you forget a filter is enabled.

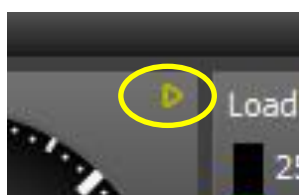

Hollow symbol indicates a filter is enabled.

Showing the Memory Panel

There are 4 memories that save all parameters for instant recall, with a toggle function for signal comparison. See the 'Memory Panel' section for full details.

Click the lower left arrow to toggle the Memory panel. Right click the arrow to also toggle the Aux I/O panel at the same time.



left click.



right click.

Showing the AUX (Auxiliary I/O) Panel



The Auxiliary I/O panel is located underneath the main side panels and is only visible when you want it to be, by using the selection arrow (underlined in yellow in the above figure).

Two independent auxiliary I/O channels are provided.

The channels can be independently configured as inputs (Monitor), outputs (Control), or Mute in / Mute out ports.

Memory / AUX panel interaction

Panel visibility is interactive in that the panel placeholders will still be visible even if the panel controls are not. This is to preserve UI symmetry. Additionally, for the same reason, when the Aux I/O panel is visible the three main side panels become visible, and the side panel control arrow (top right in the compass panel) is hidden because you can't collapse the side panels with Aux I/O present.

If you had less than all three side panels visible before you enabled the Aux I/O panel, when you cancel the Aux I/O panel the display will revert to the previous state.

Right clicking either the Memory or the Aux I/O panel selectors closes both panels (or in fact both place holders whether the controls were hidden or not). It's probably easier to deduce the operation yourself by experimenting with left and right mouse clicks.

Control Workarounds

Q: "How do I close the app if the 'x' buttons aren't visible due to my choice of hiding the Title and Menu bars?"

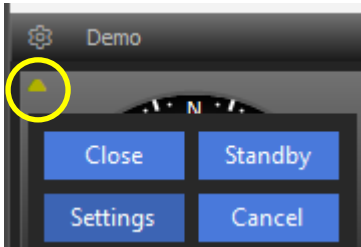

Right click the Title bar / Menu bar arrow to show a menu then press Close. The Settings button may also come in useful. Standby avoids having to expand the side panels to reveal the Levels panel.

Alternatively, if you must, you can close the app from the Windows task bar at the bottom of your screen. Right click the icon then select 'Close Window'. Note this approach won't trigger the closedown code in the app and if the LCU is powered it will remain powered.

Q: "I've changed my monitor or video card settings and now Azilooop seems to be starting off-screen. How can I get it back?"

This is even more unlikely with the latest software, which should detect off-screen co-ordinates and reset the position. But if you can't find the Azilooop window, first close the app from the Windows taskbar then restart Azilooop, pressing the keyboard space bar within the first three seconds of the app becoming active (becoming underlined in the taskbar). Note in Windows 11, a short underline means it's running but minimised. A wider underline means the app should be visible on screen somewhere even if it's hidden by other apps. Enable Topmost on Pref 1 settings to prevent this.

2.1 Antenna Control - Compass Panel

The Compass panel is where you control the antenna heading (or azimuth) and select the antenna mode (K9AY or Loop). The compass needle represents the electrical heading of the antenna, not the physical position of the loops – they never move.

It is also the centre of operations in that the visibility of all other panels is controlled from the Compass panel.

We suggest you try out the functions in the actual app while reading this section.

Overview

Aziloop uses the position of the mouse pointer in the Compass panel to determine the action to take when the mouse is clicked. Use is made of left mouse click (i.e. a normal click), right click (both short and long press), and the mouse scroll wheel. For most operations the radial distance from the compass centre is key, and so the compass can be represented as a series of concentric zones as in 1-4 below



Note:

If you see 5, 6, 7, and 8 as dots you are probably running Windows 10 and haven't installed the ttf font as detailed in the installation notes.

The Settings cogwheel will also be a dot. See [Section 6.1](#).

1. Loop mode selection zone
2. Null axis toggle zone (when enabled)
3. K9AY mode selection zone
4. K9AY mode selection zone with angle marker displayed
5. Menu Bar and Title bar panel selector
6. Memory panel selector
7. Side panel selector
8. Aux I/O panel selector

The rest of this section covers operation of the Compass panel in detail.

Heading pointer



There is a heading pointer that follows the mouse around the circumference of the compass rose. This can assist with alignment on a particular heading.

2.1.1 Changing Modes

Aziloop can operate in two antenna modes, K9AY mode and Loop mode, with the ability to switch rapidly between them.

In K9AY mode the antenna operates as a terminated loop to give a uni-directional cardioid pattern (at low angles) with a null to the rear. In Loop mode the antenna operates as a small loop with a bi-directional pattern at low angles (with a null at right angles to the loop axis), and an omni-directional pattern at high angles.

Changing Modes

Click anywhere outside the centre circle to select K9AY mode.

Click anywhere inside the centre circle to select Loop mode. The centre 'pivot pin' enlarges when you are in the Loop mode zone.



K9AY mode selected



Loop mode selected

Mode Priority

By default, the mode priority is K9AY mode (unless changed in Settings > Preferences > Antenna > Priority). For DF work in Loop mode, you can select Loop priority. You can click on a heading anywhere and the mode will stay in Loop mode.

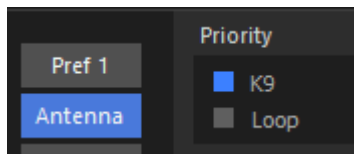

Tip: You can force a temporary change back to K9AY mode by repeatedly clicking the centre circle area which puts the app into 3-way toggle mode (Loop, K9AY and reverse K9AY). Stop when K9AY mode appears then use the mouse wheel to rotate the heading. Clicking reverts to Loop mode.

2.1.2 Changing Headings

There are several ways to achieve this. Any method can be used according to preference. They are listed here in order of amenity.

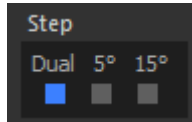

The step size is either 5 degrees or 15 degrees (or both) as set in [Preferences>Antenna>Step](#)

Method 1: Using the mouse scroll wheel (recommended)

Move the mouse anywhere within the compass rose and use the scroll wheel to change direction clockwise or anti-clockwise. The mode (Loop or K9AY) will be maintained. In Dual mode, mouse wheel rotation is speed sensitive – see below.

Scroll wheel direction

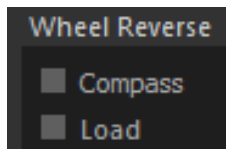

The direction can be reversed by enabling [Preferences>Pref 1>Wheel Reverse](#).

Method 2: Using left and right mouse clicks

Click on a heading, then hold the mouse on that heading and right click. This puts the app into rotate mode, which, if you maintain mouse position, allows you to left click to rotate anti-clockwise and right click to rotate clockwise. Clicking a different heading will cancel rotate mode until you re-trigger it by right clicking another heading.

Holding either mouse button down causes the app to go into auto-rotate mode until you release.

The mouse-click method defaults to 5-degree steps with Dual Step enabled allowing you to make small changes with a single click.

Method 3: Direct heading selection



You can click anywhere outside the centre circle but for accurate selection move the mouse to the edge of the rose so that the heading assist marker appears.

You can't directly select a heading from the centre circle, so this method selects K9AY mode first. Then re-select the centre circle. Alternatively select the antenna priority to Loop. ([Preferences>Antenna>Priority](#)).

2.1.3 Mouse Wheel Scrolling with Dual Step

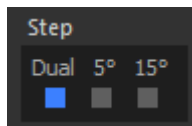

With Preferences>Antenna>Step set to Dual, the scroll rate changes depending on the mouse wheel scroll rate. Currently it is always 5-degrees in the centre circle. See below.

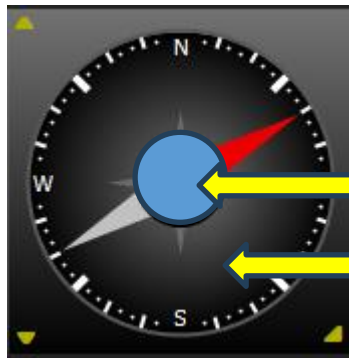

Always 5-degree scroll area

5-degree or 15-degree speed sensitive scroll area (mouse wheel).

The dual speed mouse wheel feature allows you to quickly rotate to a rough heading then fine tune to a precise heading without need to move the mouse position.

Dual is the default setting, recommended for most users.

2.1.4 The two-way toggle (K9AY mode)

Click on a heading. Then click the same heading again. The compass needle now flips to point in the reciprocal direction. Click again to toggle back to the original heading and so on. This allows a quick comparison between front and back reception in K9AY Mode.

Note: if the next click is a right click, you are enabling Quick-Step mode, and the antenna rotates to the next step clockwise. Rule: on a new heading, it's Left click to toggle, right click to rotate.

2.1.5 The three-way toggle

Click on the compass centre to select Loop mode then click the centre again until K9AY mode is selected on the same axis. Click again to go back to Loop Mode. Click yet again to return to K9AY mode but this time in the reciprocal direction. Continue clicking to sequence between the three states.

2.1.6 DF Assist Options

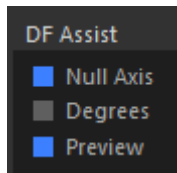

When attempting to locate a station by DF (Direction Finding) the preferred method is to use Loop mode, rotating the antenna for the best null. The station heading will then be along the null axis which is at right angles to the compass bearing.

Null Axis

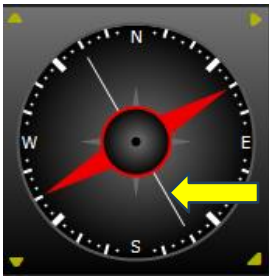

With Null Axis enabled, when in Loop mode a thin line appears at right angles to the plane of the loop. This indicates the null axis in the figure of eight pattern. It is more accurate to DF a station using a loop's null than to use the much broader main lobe to peak the signal. You can then use K9AY mode to resolve the heading ambiguity.

Null Axis Toggle



With Null Axis enabled, you will also notice that a coloured ring appears when the mouse is in that position.

Keeping the mouse in this zone, repeatedly click to toggle between main and null axes.

Alternatively, you can use the mouse scroll wheel to do the same thing.

Degrees

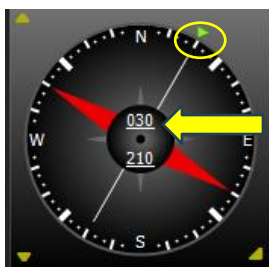

With Degrees enabled, a digital readout of the forward and reverse angles is displayed. In K9AY mode the upper readout is the heading, the lower less prominent readout is the reciprocal. In Loop mode both readouts appear with equal brightness.

When the green heading marker is visible and aligned to the null axis, the angular readout changes to the null axis angles, and the digits become underlined.

Preview

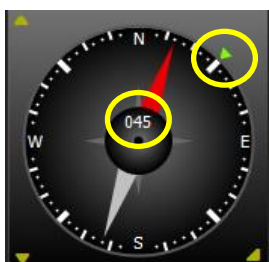

With Preview enabled, the location of the Heading Assist pointer is displayed in the compass centre in degrees.

We don't recommend enabling Degrees and Preview at the same time.

2.2 Load Panel

In K9AY mode the antenna operates as a terminated loop. The load value often quoted is 450 Ω , but a fixed value is not necessarily the optimum for your installation or use case.

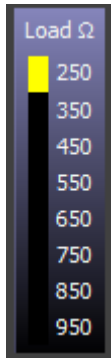

There are 15 termination values available from 250 Ω to 950 Ω , selectable in 50 Ω increments. The end values will rarely be used but offer the satisfaction of being able to 'tune through' the optimum value.

Hover the mouse anywhere in the load panel and use the scroll wheel to change value (recommended method).

Alternatively select a load value by clicking on it. Then, having selected a value, continue to left or right click the same position to scroll the value. You can also left or right click the Load Ω label.

If you hold the left or right mouse button down for > 500 ms the load value automatically increments or decrements. But it's far easier to just use the mouse scroll wheel.

In Loop mode the Load value is not relevant and can't be changed.

Optimum value

When using Azilooop in K9AY mode for DX listening there will often be little to choose between adjacent load values when comparing front-to-back ratios. In any case the usual rapid fading on such signals makes optimisation a challenge. The most noticeable effect is when unwanted signals can be placed in the 'sweet spot', which is the notch between the forward and the rear lobes. See the [K9AY party trick](#) in Appendix 2 for more information.

An appreciation of the K9AY lobe pattern will explain why the front-to-back ratio varies markedly depending on arrival angle and is poorer at higher angles.

Load end stop

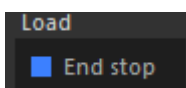

Select Settings > Preferences > Pref 1 > End Stop to prevent the load value wrapping round again from the opposite end of the range.

Reverse

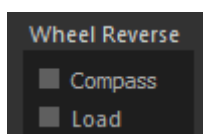

Select Settings>Pref 1>Wheel Reverse to alter the mouse wheel direction according to preference.

2.2.1 Compass panel Load

To minimise the UI footprint when required (e.g. to place on top of an SDR UI) you can hide all other panels to leave just the Compass panel visible. To maintain access to the Load control, a load adjustment windows now appears in the compass rose.



Adjustments can be made using mouse clicks or the mouse scroll wheel. Automatic increments also work when you keep a mouse button pressed.

To maintain the 3D illusion the compass needle passes over the load value and may obscure it, but mouse-over reveals the complete value.

2.3 Band Panel

The Band panel, or pre-selection/roofing filter panel if you prefer, controls three selectable seven pole filters - two low pass, and one high pass. The 'upper' low pass filter overlaps with the high pass filter to create a band-pass filter when both are enabled. The filters themselves are housed in the LCU prior to the switchable preamp.

If you don't need the filters don't use them, but they are there for when you do. For instance, many listeners are unfortunate enough to live close to high power LW/MW broadcast stations that can play havoc with sensitive receiver frontends, and many shortwave broadcast stations can generate punishing signal levels in the early evening.

Note: The app now includes an Omni-Rig interface, with the ability to enable filter tracking with frequency.

Frequency visualisation

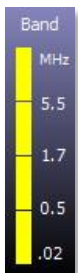

If a band sector is lit, you can hear things in that sector.

The bar is divided into four sectors. There are four filter options, with some lighting more than one section. When all sectors lit, no filters are in use. Response is then from 20 kHz to beyond 30 MHz. Move the mouse over the bars to preview the filters.

20 kHz to 500 kHz low pass filter

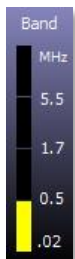

Click the .02 to 0.5 Sector to select the 500 kHz 7 pole low pass filter. This is useful for VLF listening and NDB DXing etc. to minimise overload from strong MW broadcast stations or elevated HF signals at night-time. The frequency was chosen to just include the 472 kHz amateur allocation as well.

20 kHz to 5.5 MHz low pass filter

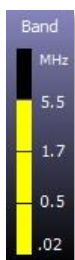

Click the second sector up, marked 0.5 to 1.7 to select the 5.5 MHz low pass filter. In addition to the sector you clicked, the display shows all three sectors that are now open.

The 5.5 MHz edge was chosen to just include the 60 m amateur allocation. The 40 m amateur band didn't make the cut as the 7 MHz and 9 MHz broadcast bands are too close.

1.7 MHz to 5.5 MHz band pass filter



Click the 1.7 to 5.5 sector. In this case you will see just that sector lit, even though there is no actual band-pass filter for that sector. Aziloop is automatically selecting the 1.7 MHz high pass filter and the 5.5 MHz low pass filter together, creating a band-pass region where they overlap. For many amateur radio users this will be the filter of choice as it covers the 160 m, 80 m and 60 m bands.

1.7 MHz to 30 MHz high pass filter

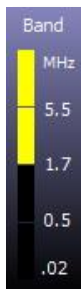

Click the top sector. In this case you will see the top two sectors lit. This is a good option if you suffer from strong nearby LW and MW broadcasts and have no interest in listening below 1.7 MHz.

Bypassing the Filters

Click the selected filter a second time to bypass all filters. Repeated clicks toggle the filter in and out.

<Tip> the 'Band' label also acts as a bypass toggle button. Successive clicks toggle between the last filter selection and no filter.

“How do know a filter is in if the Band panel isn't visible?”

The 'panels' arrow becomes hollow if a filter is active and the Band panel is hidden.



Bear in mind you need to keep note of the filter state otherwise bands can seem strangely quiet!

2.4 Levels Panel

This comprises three sub-panels – preamp, attenuator and on/off.



The Levels panel permits the user to achieve the best combination of signal level and sensitivity depending on receive conditions and the capability of the receiver. Once the best signal to noise ratio is achieved there is little point in increasing levels further. Some SDR receivers have a signal-to-noise meter which can be useful in determining the correct level.

Preamplifier



Clicking 'Pre' selects or de-selects the (nominally) 18 dB gain balanced preamplifier, located in the LCU after the band filters. A permanently in-line low pass filter kicks in above 30 MHz to reduce the chance of overload from local Band II broadcast or other VHF services (or indeed your own higher frequency transmissions).

Attenuator



The attenuator sub-panel controls the switched attenuator located in the CIU. Select 0 for no attenuation, or -6, -12 or -18 dB as preferred.

Together with the Preamplifier, you have around 36 dB of level control at your fingertips.

Click a level directly or left / right click to step through levels.

Receiver isolating – the infinity option

The infinity option disconnects the receiver from the Aziloop circuitry and terminates it in a 50 Ω (actually, 54 Ω) load. Handy for locating any noise sources, or manually isolating the receiver. This is also the attenuator state when PTT Mute is active unless [silent mute](#) is selected.

Start / Stop or Connect / Disconnect Button.



Start/Stop



Connect/Disconnect

The action depends on the current mode of operation:

Local Mode

In Local mode the button controls power to the LCU.

Start button in Client mode

In Client mode the button icon changes to the link symbol. The button is used for managing the remote server connection.

Connection:

The button either initiates a server connection directly or opens the Client IP Manager panel for a server to be selected, depending on the 'Auto Connect on Start' setting in the Client panel. This is covered in more detail in the Client Server Operation section.

Disconnection:

Clicking while connected drops the connection to the remote server.

Start button in Server Mode

In Server Mode the button and starts or stops the app, applying or removing power to the LCU in the same way as Local mode.

<p>Note: even with the app stopped (LCU off), an incoming Client connection will power-up the LCU.</p>

In Server mode the UI can be operated locally as if it is in Local mode. When a connection from a client exists, any changes made at the server end are conveyed to the client end and the two UIs stay in sync.

2.5 Memory Panel



Click to toggle the Memory panel.

The Memory panel is located underneath the Compass panel and is only visible when you want it to be, using the selection arrow. It allows you to essentially take a snapshot of the UI state for recall later. Each memory also stores the Aux I/O state which will be reproduced on memory recall.

Saving to a Memory



Right click one of the four Memory buttons and hold down for > 500 ms. The delayed action helps prevent inadvertent over-writing.

The memory name is displayed briefly in the Menu bar even if Preferences > Pref 1 > Memories > Names is disabled.

There are four independent memories. As with many Aziloop functions, use is made of left and right mouse buttons, in this case left click to recall a memory, right click for > 500 ms to save a memory.

Hover your mouse near one of the Memory buttons and it will light up to indicate it's now selectable. You will also see a name panel appear unless Preferences > Pref 1 > Names is de-selected.



Recalling a Memory

Click any one of the four Memory buttons. Aziloop parameters now change to the stored values. The button stays lit until a new command (heading, load etc.) is selected.

Memory Toggle

Click the same memory again to toggle back to the previous settings. The memory LED stays lit until it becomes invalid (when you alter something e.g., a new Load value).

Naming a memory

Assuming Preferences > Pref 1 > Memory > Names is enabled, when you save to a memory, a cyan text box with the memory name appears. Move the cursor with the keyboard arrow buttons or backspace and start over. Press Enter on your keyboard when done.

Aux I/O

Each memory also stores the Aux I/O state as long as the channel(s) are set to 'Control' in Settings>Aux.

The state is recalled as long as Pref 1>Memories> AUX I/O is enabled, and the channels are set to 'Control'.

Why Memories?

Some examples:

- Off-Axis toggle:

If co-channel stations can be separated but they are not on the same axis (so 2-way or 3-way toggle won't help) or not 90 degrees apart (so the null-toggle won't help), store the setting for one station in a memory then set the compass up for the other one. Press the memory repeatedly to toggle between the two.

- Set a reference:

Store the settings for a known station as a reference or store the settings for your favourite frequency.

- Unattended operation – see [Azi-Auto](#) feature.

This allows different headings etc to be automatically switched-in when trigger times are reached. Because the memories can also store the I/O channel state and reproduce it on recall, I/O lines could for instance be used to automatically select different antenna or different receiver.

Azi-auto was an add-on suggested by Steve VK5SFA. He uses it to alter Aziloop headings overnight as propagation changes while he records LF DX happenings, to review next day.

2.6 Aux I/O Panel

Two undedicated auxiliary I/O channels are included for use as inputs or outputs. They can also be enabled as PTT inputs and outputs to protect Aziloop (and your receiver) during transmit. See the [Settings >Aux](#) section for full details.

Showing the Aux I/O Panel

Click the lower right selector to toggle the Aux I/O panel, or right click to toggle the Memory panel at the same time. The main side panels become visible when the Aux panel is shown, to preserve UI shape. Side panels revert to their previous state when the Aux panel is removed.

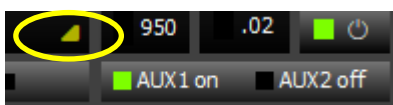

The Aux 'LED' on / off colours can be changed in the [Palette Manager](#).

The Aux panel setup information can be reached via [Settings >Aux](#).

AUX settings shortcut

Right click either Aux I/O channel name label to directly open the AUX setup panel.



3.0 SETTINGS

If you remember nothing else:

All settings are reached via one place, here on the Menu bar:

(If you see a dot instead of a cogwheel icon, you are probably running Windows 10 or earlier, and need to install the font supplied in the setup.zip package)

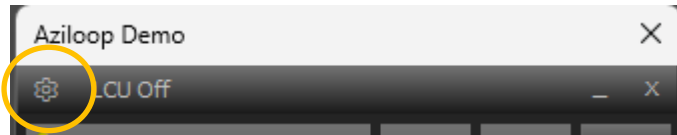

Click to open the Settings panel.

Click the icon again to hide the panel or press the 'Exit' button in the panel.

Settings Panel

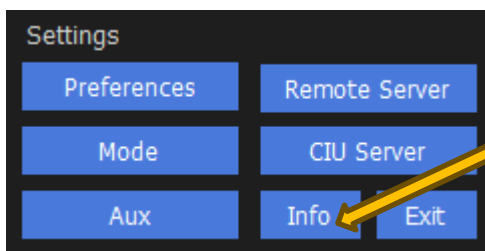

Hover your mouse over Info to see the COMport in use.

Long press to restore settings to defaults.

Preferences shortcut

Right click the Settings icon to go straight to Preferences. One less click.

Reset Aziloop to default settings

Long press the Info button for > 2 seconds to restore defaults. Restart the app if it doesn't auto start

Which COMport?

Hover over Info to see the COMport in use.

Sections 3.1 to 3.6 below describe each Setting option in turn.

Sections 4.n describes the Preferences options.

3.1 Settings - Mode

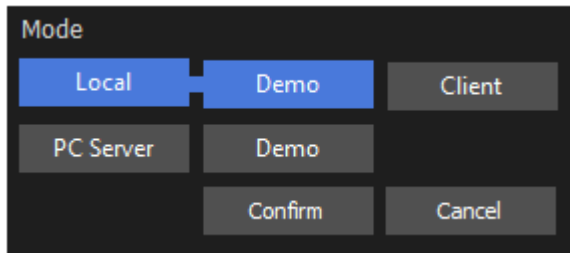

This is a key setting as the mode defines the way the app operates. There are three main modes, Local, Client and PC Server. Local and Server modes also have a Demo option where no hardware is required. Client mode doesn't need a demo option as no hardware is needed at the client side anyway. Select the required mode then press 'Restart'.

CIU Server is an additional mode using the CIU's built-in UDP server. It is configured from the Settings panel, and once set up, runs separately (or alongside) the PC app.

On first installation the default mode is set to Local-Demo.

Local and Server modes need a valid USB port to communicate with the CIU, as does CIU Server during configuration. If no port has been defined you will be prompted to set one.

Local mode

For most users, Local mode will be set then never altered. This is the mode for single site operation with a direct USB link from PC to CIU.

The other modes are used for client server (remote) operation, which is covered in detail in [Section 5](#).

Client mode

When the operator is located at a remote location, assuming an internet link is possible, Client and Server modes are used (one PC at each end). Select Client mode at the operator end and Server mode at the antenna end. You'll also need to configure your router at each end for this to work (see [Section 5](#)).

To just test the link, set the mode at the Server end to Server-Demo which runs without a CIU present.

Alternatively, the antenna end can use the CIU's built-in server if a PC is not otherwise required.

Server mode

Server mode is used at the antenna end of a client server link. You'll also need a PC at the Client end running Aziloop to make the connection. You'll need to configure your router at each end for this to work (see Client Server section).

Once Aziloop loads it is available to clients. You don't need to press 'On'. The link setup handshake manages LCU power-up.

If you do elect to press 'On' then power is applied to the LCU when the Server is in standby (un-linked) mode, which may be preferable in cold conditions. At the Client end, the 'LCU off on dis-connect' option in Settings > Server Selector allows the client to control the LCU power when closing the link.

To test out a link, set the mode at the Server end to Server_Demo which simulates a CIU.

3.2 Settings – AUX

Shortcut: Right click a channel name in the main display to open AUX settings.

Two I/O channels are provided in the CIU. The Aux Configuration panel is used to set what the channels do. Until altered they initially present as 'Disabled' (in Demo mode they always simulate 'Control').

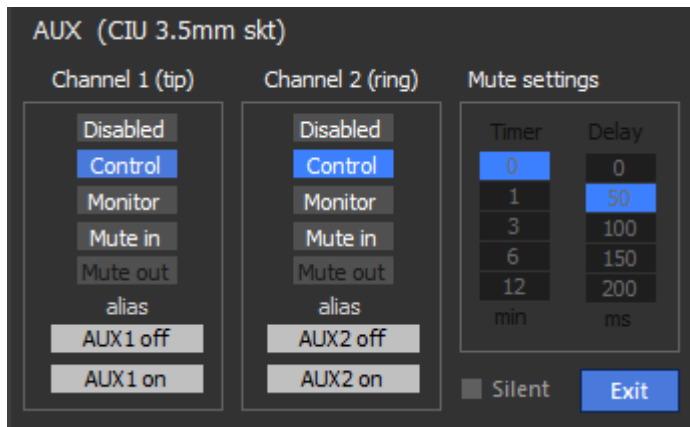

Channel 1 and 2 settings are identical but interact when mute is selected. I.e., you cannot select Mute out unless Mute in has been selected on the other channel first. Both channels can be set to Mute in.

Selecting Mute in (or also Mute out) enables the Mute settings panel – discussed separately below. Current settings are shown even when disabled.

Physical

The physical interface for the channels is the 3.5 mm socket on the CIU. The tip is Channel 1, the ring is Channel 2, with the sleeve as the common negative, which is the 13.8 V negative rail. The CIU case is also connected to 13.8 V negative.

Aux channel Options

Disabled: The default setting. No control or monitoring function. The I/O pins are still live with around 4.3 V present when floating.

Control: Allows the state of the I/O channel to be altered. If the state is altered externally this is also detected and displayed.

Monitor: External control inputs are detected. No control is possible.

Mute in/out, Silent: See below.

Alias: The name of the channel can be altered for both On and Off. It is effective in Control and Monitor modes. It is preset in the other modes. There are two fields per channel. The upper field is shown when the channel is Off and the lower when the channel is On. To edit the name, click on the field and alter as required. The new name is saved on exit.

Action in Client mode

The I/O configuration cannot be changed from the Client side. When connected to a server, the Client I/O configuration inherits the settings defined by the server. Currently this does not include the channel alias.

Electrical

The tip and ring connections are combined inputs and open drain outputs. The sleeve connection goes to the negative rail of the 13.8 V feed. If you introduce circuitry powered from other sources pay attention to earthing to avoid current loops that may affect the receiver noise floor.

Aux channel as Input:

Applies to Control, Monitor, and Mute In modes.

Grounded = On. Unterminated = Off.

Standing voltage 4.3 V.

Short circuit current 4 mA.

On Off thresholds:

- For reliable On: Shunt resistance to 0 V < 100 Ω.
- For reliable Off: Shunt resistance to 0 V > 1 kΩ.

Bridging with a 1N4148 will enable the On state. Useful when isolating lines.

Aux channel as Output:

Applies to Control and Mute Out modes.

Grounded = On. Open circuit = Off

There is a standing voltage of 4.3 V present unless overridden by a higher external voltage. (internal diode isolation on 4.3 V)

Open drain operation. Max sink current 50 mA @ 13.8 V (abs max +24 V)

- Do not connect I/O lines directly across a power supply.
- Always use a relay driver board or external device for high power switching.
- Place a reverse diode across the coil of any directly connected signal relays.

Control (or Mute Out) example:

The channels will easily operate a 12 V low current signal relay with a typical coil resistance of 1 k Ω . Make sure you fit a suppression diode across directly connected relays. Do not sink more than 50 mA.

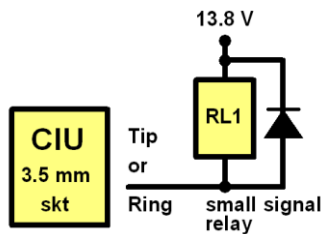

When switching circuits other than low current common earth circuits, the recommended solution is to use a relay driver board (example pictured below) that has a driver device included. These are readily available from many outlets.



Typical 2 channel relay board.

Monitor (or Mute in)

Unconnected, the channels present approximately 4.3 V at the tip and ring connections. This is the 'Off' state.

Pulling the channel to ground creates the 'On' state. Anything less than 100 Ω to ground will reliably produce the 'On' state.



The colours representing on and off can be changed using the Palette Editor.

<Tip> Right click on either channel name to go to AUX settings.

Note: When configured as Control, the Aux channels are also monitoring the channel and will show level changes caused by parallel connected external circuitry such as an external PTT line.

Can I be sure it's working?

The Aux channels function as combined inputs and outputs. So, when you activate a Control channel (and see the colour of the button change), that physical Aux channel itself is detecting the electrical change via its input circuitry, and it is this signal, fed back from the CIU, that changes the colour of the Aux button indicator, i.e., the Control channels effectively monitor themselves. This is also the case in Client Server operation, giving the remote operator confidence an action is successful.

Aux operation in Client Server mode

At the client end of a link there is no CIU, and the Aux I/O settings cannot be altered. However, when a link is active the Aux I/O settings of the server are conveyed to the client. Thus, if the server has both channels set to Control, the client end will be set similarly. Remote operation of the Aux I/O channels from the client end is therefore possible if permitted by the server Aux I/O settings.

Changing the Channel Name (Alias)

Each channel can be renamed in Control or Monitor Modes. Click the text boxes and edit as required. The names are pre-set in Mute in, Mute out and Disabled modes.

3.2.1 PTT Mute Function

At transmit capable sites, to help protect Aziloop and any connected receiver from possible damage from excessive RF energy, the built-in muting facility should be used. Selecting 'Mute in' as the control mode allows an Aziloop Aux input to be placed across the PTT bus to detect a key-down. 'Mute out' allows Aziloop to 'regenerate' the PTT signal ensuring no further downstream actions can take place without Aziloop being muted first. There are also some extras built in by way of a Mute out delay and a Mute timer.

Note: During muting the loops cannot be disconnected entirely, though RF from the loops is reduced as much as possible, and the preamp is disconnected. Before that happens, the CIU isolates the receiver port, terminating it in 50 Ohms (this is the same as applying the 'infinity' attenuator setting).

Do not rely on muting alone. Your first line of defence is physical separation from the transmit antenna.

Mute In

When activated, Mute in isolates the receiver in less than 10ms, and the LCU enters Mute mode 35 ms later. Recovery times are similar.

Mute Out (Open drain)

When enabled, Mute out goes low immediately, or after a preset delay period following a Mute in signal.

The safest way of operating is to connect the Mute in to the line that would normally key the transmitter, and arrange for Mute out to key the transmitter instead, preferably with a delay if the transmit requirements can accept it.

In practice the best compromise may be to attach Mute in to the PTT out signal that most transceivers provide, and if you use an external linear, instead of keying that via the transceiver's PTT out, key it via the Aziloop PTT out instead. In this setup a PTT out delay may not be appropriate due to the risk of hot switching unless your transceiver has a transmit delay

In any case, the first line of defence against RF overload should be the physical separation between the Aziloop antenna and the transmit antenna(s).

Mute Options

A few house rules: Mute out per channel is not enabled unless Mute in is selected in the other channel. Delay is not enabled unless Mute Out is enabled. The Mute timer is not enabled unless Mute in is selected.

Both channels can operate as Mute in concurrently but clearly you can't have both channels as Mute out. If you only need one Mute in you can do something else with the other channel or disable it.

Mute Settings

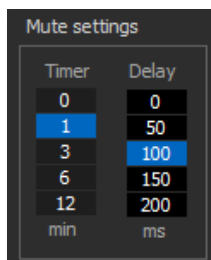

The Mute Settings sub-panel exposes two additional settings as described below. Timer is only active when Mute in is selected, and Delay is only active when Mute out is selected.

The Silent treatment

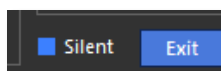

Setting available when at least one channel is set to Mute out.

Normally PTT Mute in sets the attenuator to infinity during transmit. When this is not required e.g. for a transceiver with a separate receive input, enable to remove audible CIU relay noise. LCU muting is not affected.

Use responsibly to avoid damage to connected receivers that are not otherwise isolated during transmit.

Mute Clock or PTT 'talk timer'



Whenever Mute in is active a 'mute clock' appears in the Compass panel indicating the 'key down' time in minutes and seconds.

Mute Timer (or Talk Timer) progress ring

Any Timer setting other than '0' enables a time progress ring along with the Mute Clock.



The Compass perimeter becomes a time ring, with 360 degrees representing the complete time-period set. i.e., if Timer is set to 3 minutes, then the time ring completes a revolution in 3 minutes. The colour (red here) is taken from the Compass pointer colour setting.

After the timer completes one revolution the time ring then halts, maintaining a red circle. The time digits carry on incrementing until Mute is released.

The PTT function can also be triggered via Omni-Rig.

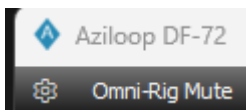

This is displayed if the PTT was detected via Omni-Rig.

Mute Delay

This setting defines the time between Mute in being detected low, and Mute out being driven low. Set to Zero for no delay i.e., Mute out is co-incident with Mute in detection.

The Mute Delay panel is enabled when Mute out is selected on a channel.

3.2.2 Dealing with PTT lines

Adding Aziloop's Mute in / Mute out lines to a PTT daisy chain can ensure that Aziloop mutes before any potentially damaging RF appears, especially if you add a delay to PTT out.



There are potential problems here with most amateur radio transceivers in that you cannot daisy chain the PTT line, it's internal when the front panel MOX or TUNE buttons are used, and even if you broke into the mic lead the MOX / TUNE issue remains.

The best option in practice may be to connect Aziloop's Mute in line to the PTT out pin of the Aux connector that is usually present on modern kit. A lot of equipment also has a settings option to delay transmit RF which could help with timing.

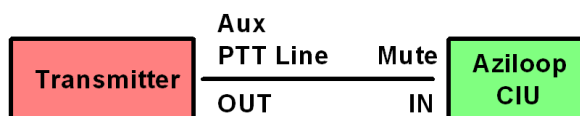

When a linear amplifier is in circuit in an amateur radio installation, the amount of RF present is likely to increase by at least 6 dB (which is double the RF voltage). We suggest the best option is to always key a linear via Aziloop's PTT out. This way you are certain the Aziloop has detected the PTT and acted on it.

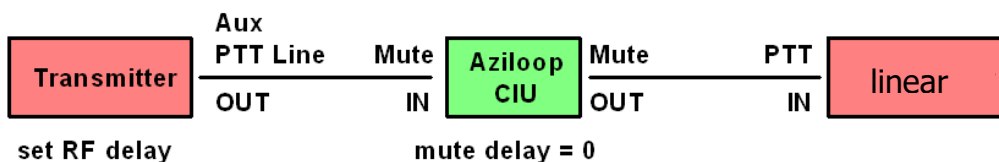

Set the RF hold-off delay on the transceiver to 50 ms if possible and set the Aziloop mute out delay to 0 ms **to avoid hot keying the linear.**

The further apart the transmit and receive antennas are the better of course. This should be your first line of defence.

Two PTT lines

If you have two transmitters and can't mix the PTT lines, you can designate both I/O channels as Mute in so they operate logically as an OR gate.

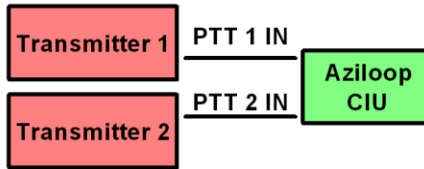

Multiple Transmitters

Alternatively, you can connect the PTT lines from many transmitters if you separate the key lines with diodes, which frees the other Aziloop I/O channel for use as PTT out, or anything else you wish.

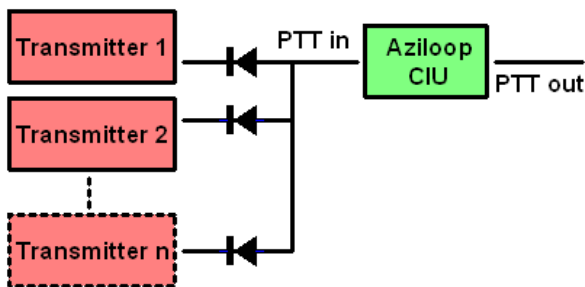

Multiple Key Lines

Many configurations are possible, like this suggestion for transmitter specific PTT out lines each keying a separate linear amplifier but only after Aziloop mutes.

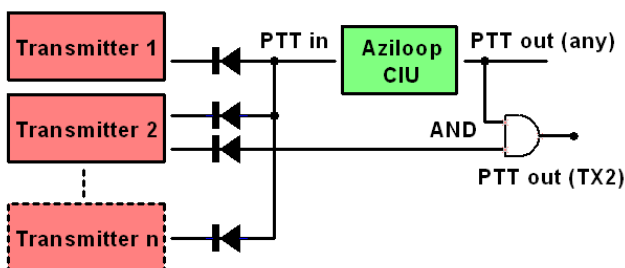

3.3 Settings - Info

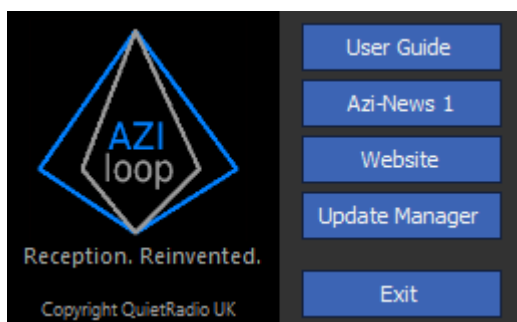

← Hover over User Guide for current revision number.

← Hover over Azi News for current issue number.

(As long as Tooltips are set to on in Preferences > Pref 1)

Note: You need to be online for the Info panel to work correctly

User Guide

Click **User Guide** to download the Aziloop User Guide (this document). It is a PDF viewable directly from your browser or you can download it. Best to always view online to be sure you're seeing the very latest info.

Azi-News

Online alerting method to inform users of app or firmware updates, or new products.

Website

Click to go to the Aziloop website.

3.3.1 Code Updates

Press Update Manager to open the panel. This allows you to download the latest app, or to update the CIU firmware if a newer version is available.

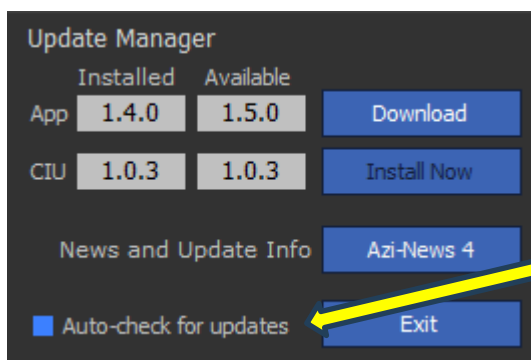

Keep Auto check for updates enabled to be alerted of new Azi-News issues.

See Sections [6.1.2](#) and [6.2.2](#) for more information about updates.

Updating the App

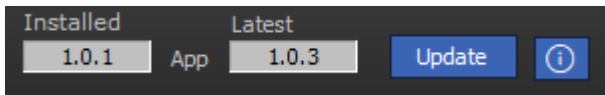

Click **Update** then follow the instructions:

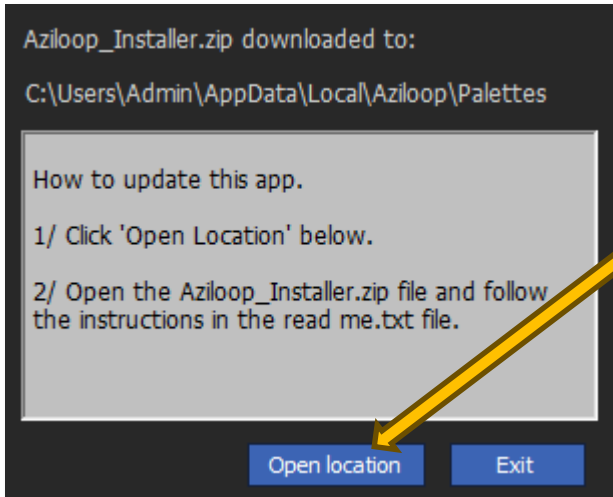

Note: You will need to uninstall the old version of the app first.

Click to go to the download location. You may need to remove any old .msi files before decompressing the new .zip (or you can open the new .msi from within the zip).

You can return to this folder by selecting Preferences > Palette > Path and copying the address path.

Uninstalling the previous app version

You will always need to uninstall any previous versions of the app before you install a new one, though as above, you can download the new file from the old app before you delete it.

If you try to install a new version without uninstalling the old one you will see this message (Windows 11):

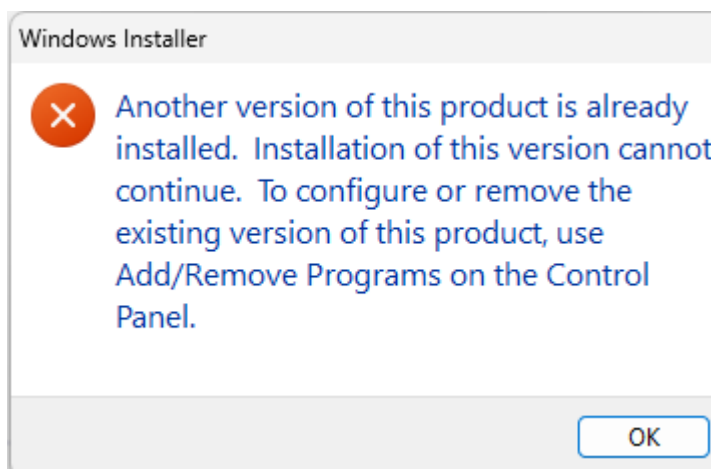

Updating the CIU Firmware

The CIU ships with firmware already installed, and updates are rare. However, the facility is there should the requirement arise.

Pre-requisites

The CIU Update button is only enabled when a newer version is available. Set the app to Local mode with USB connected (because comms to the CIU is required). Your PC must be connected to the internet (to get the updates), and the CIU 13.8 V supply must be present (to power the circuitry).

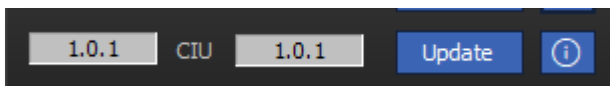

If enabled, click **Update**.

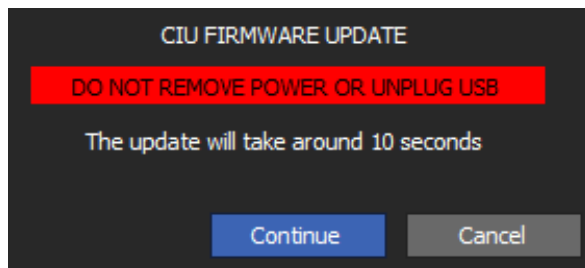

Two confirmation steps are required before the actual update begins. For the timid, there is a cancel button. For everyone else, press Continue.

If the CIU Server or LCU are active, they will be powered off once Continue is selected.

Caution:

You could 'brick' the CIU if you interrupt the update once in progress. Do not switch anything off or unplug the USB cable during the update - which only takes around 10 seconds. In practice updates have been 100% reliable. But there's always a first time hence our advice.

We use this method ourselves for programming the CIU during final commissioning, and we also ran a test of 1,500 consecutive updates overnight with no failures.

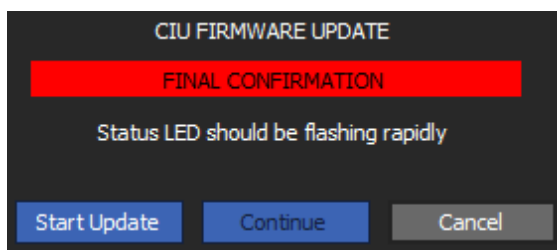

Ensure the Status LED on the CIU is flashing rapidly then press **Start Update**. The LED will flicker in a more random manner while the update takes place.

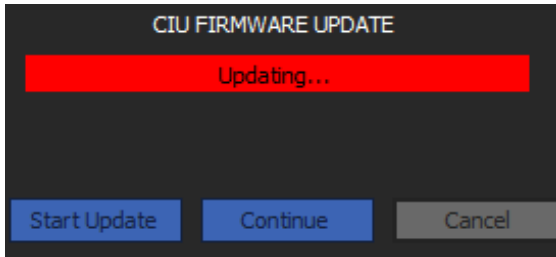

Update in progress.

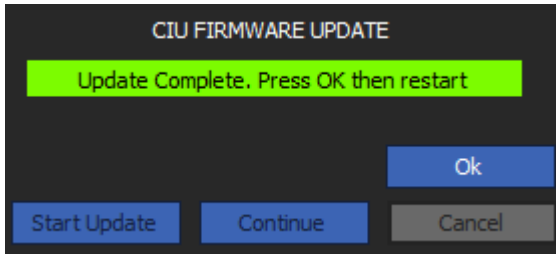

Update complete. Press Ok.

The Status LED will flash the morse code 'R' on completion. After clicking Ok the app will close. Manually restart it.

You may wish to re-visit Settings > Info > Updates Manager to check the installed firmware version has now been updated to the latest version. The 'Installed' and 'Latest' values should now be the same.

3.4 Settings - Preferences

The Preferences panel is a Settings menu option.

Preferences are changes that in the main do not affect the basic operation of Aziloop. They are essentially customisations (such as changing colours) and enhancements such as Omni-Rig support.

- Click the Settings (gear) icon on the Menu bar then click Preferences.
- Preferences always opens on the last used sub-section.

Side-by-Side view

To display the Preferences panel alongside the main panel right click on any sub-section title. Alternatively, you can right click Preferences in the main settings panel.

This allows changes to be tested as you make them, without needing to open the Preferences panel every time.

[Section 4.](#) below covers Preferences in detail:

Shortcut: Right click the gear icon to open Preferences directly.

3.5 Settings - Remote Server / PC Server

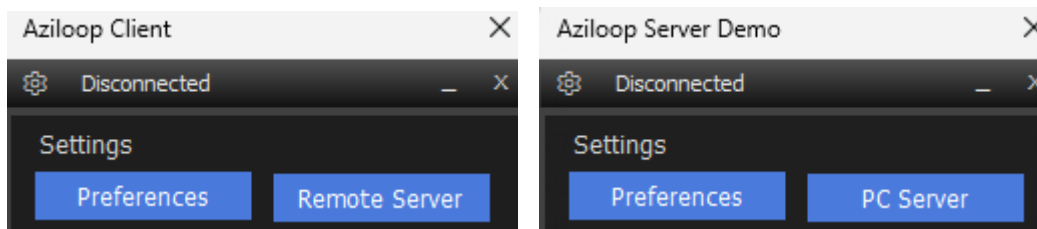

Labelling depends on the mode in use.

“Remote Server”

In Client mode. Remote Server opens the [Server Selector panel](#) from which you can choose your target server, or add a new one etc.

“PC Server”

In Server or Server Demo mode, PC Server opens the [Server Setup panel](#).

3.6 Settings - CIU Server

CIU Server mode

This mode does not require use the PC app or USB connection once the CIU has been configured. The app can be run alongside the CIU server – indeed putting the app into Client mode is a good way of testing the CIU server.

CIU Server setup is discussed in detail [here](#).

4.0 PREFERENCES

Preferences are a sub section of Settings but can be reached directly by right clicking the gear icon (that selects Settings with a left click). Broadly, Preferences are user choices that customise the function of Aziloop. Other options under Settings could potentially stop Aziloop working if wrongly configured.

Taking each menu option in turn:

4.1 Preferences - Pref 1

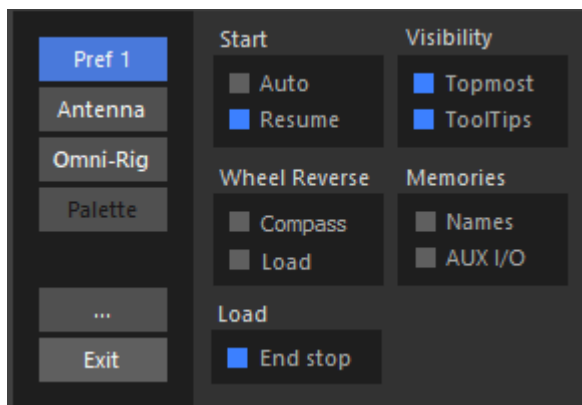

Preferences opens with the last selected sub section visible.

The menu option `...` opens a second set of preferences, discussed [below](#).

Start

- **Auto**

On app load, the 'On' button (or connect button in Client mode) is in effect automatically pressed for you. This is a handy time saver, but another use is in remote systems where Aziloop is required to automatically start, powering up the LCU after a reboot or power cycle. In Client mode, if 'Auto connect on start' is enabled in the Server Manager panel (only visible in Client Mode), the app will attempt to connect to the target server. If the connection fails, the Server Manager panel will be displayed.

- **Resume**

Essentially, picks up where you left off in terms of the heading, Load, levels etc. When disabled, Aziloop starts in a default state.

Visibility

- **Topmost**

Force the Aziloop app to stay uppermost in the Z-order to prevent other apps hiding the UI.

- **Tooltips**

Most controls and panels have a mouse-hover tooltip associated. Cancel if not required or once you get to know your way around.

Wheel Reverse

- **Names**

Reverse the action of the mouse wheel according to your preference.

Memories

- **Names**

Displays a user editable name for each of the four memories on memory mouseover.

- **AUX I/O**

When a memory is stored, the state of the Aux I/O lines is also stored. On memory recall the I/O state is applied to the I/O ports.

This is only active when the I/O channel is set to 'Control' in the AUX setup panel.

Note you can choose to just use one I/O line this way and for instance still use the other as a PTT mute input.

Load

- **End Stop**

When enabled, Load values stop when each end of the load range is reached. Load values wrap around when End Stop is de-selected.

4.2 Preferences - Antenna

Antenna preferences change the way the antenna operates by altering mode priority, step size etc.

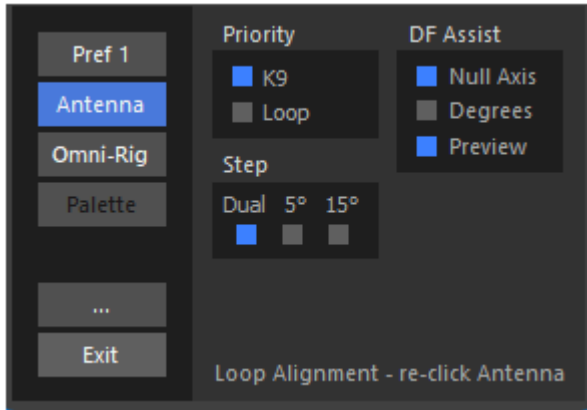

Priority

The usual setting is K9. This allows you to click a heading in K9AY mode, dropping back to Loop mode when then the compass centre is clicked. If the main use is DF work, it may be preferable to set the priority to Loop, to stay in Loop mode when changing headings.

Even in Loop Priority you can force a change back to K9AY Priority by repeatedly clicking of the compass centre, until a K9AY heading appears. The next time the compass centre is clicked, Loop priority resumes.

DF Assist

On first installation both options are enabled so alert the operator to the fact they are there.

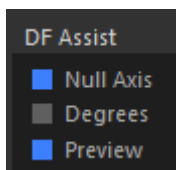

When attempting to locate a station by DF (Direction Finding) the preferred method is to use Loop mode, rotating the antenna for the best null. The station heading will then be along the null axis. To resolve the direction ambiguity, click one end of the null axis line to 'beam' along that axis, then use the three-way toggle method or click a heading to select K9AY mode then use the two-way toggle. Remember a loop is essentially omnidirectional when receiving high angle signals and K9AY mode will show very little front to back difference. Refer to the plots in the appendices.

Null Axis

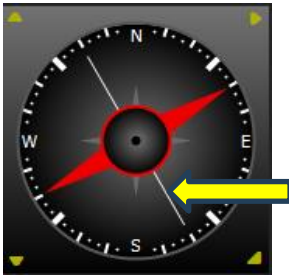

With Null Axis enabled, when in Loop mode a thin line appears at right angles to the plane of the loop when the mouse enters the centre circle. This indicates the null axis in the figure of eight pattern. It is more accurate to DF a station using a loop's null than to use the much broader main lobe to peak the signal. You can then use K9AY mode to resolve the heading ambiguity.

Null Toggle

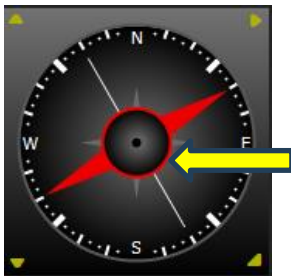

With Null Axis enabled, you will also notice that a coloured ring appears when the mouse is in that position.

Keeping the mouse in this zone, repeatedly click to toggle between main and null axes.

Alternatively, you can use the scroll wheel to do the same thing.

Degrees



With Degrees enabled, a digital readout of the forward and reverse angles is displayed.

In K9AY mode the upper readout is the heading, the lower less prominent readout is the reciprocal.

In Loop mode both readouts appear with equal brightness.

Preview



With Preview enabled, the location of the Heading Assist pointer is displayed in the compass centre in degrees.

We don't recommend enabling Degrees and Preview at the same time.

Step

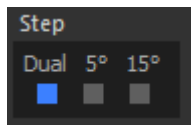

Steps of 5 or 15 degrees can be selected. Additionally, there is the 'Dual' option which, when using the mouse scroll wheel gives a wheel speed dependant step size of 5 or 15 degrees.

Dual mode



5-degree scroll area

5 or 15-degree scroll area with mouse wheel (depending on scroll speed)

For normal use we recommend leaving the Step setting set to Dual.

Antenna Alignment – hidden option

This is an adjustment that should only be made when the antenna itself is erected. If you can't align the loops with the cardinal points, choose a 15 degree offset in the panel.

This adjustment is not available when in Client mode.

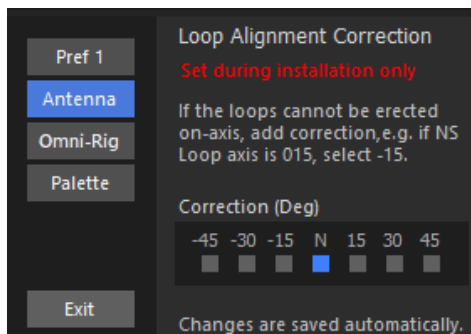

If you happen to inadvertently click Antenna again you will see the Loop Offset panel. This is described in the Installation section [here](#).

4.3 Preferences – Omni-Rig

Aziloop is now Omni-Rig aware. Currently only version 1.2 from VE3NEA is supported (not version 2.0).

Overview

The Aziloop Omni-Rig feature allows you to choose what action to take depending on the transmit state and operating frequency of the target device. You can select Rig 1 or Rig 2 (as defined in the VE3NEA Omni-Rig app), have the active source mute Aziloop on transmit, and/or activate either or both Aux I/O lines. Also, using Band Tracker you can automatically activate one or more band filters when the selected Rig is on a frequency in that range. The sources can be re-named.

Transmit / receive status is reported along with the Mode. PTT actions are valid when the active rig source is detected as being in transmit.

Additionally, Rig Sync lets you track two rigs either locally or remotely.

Omni-Rig panel

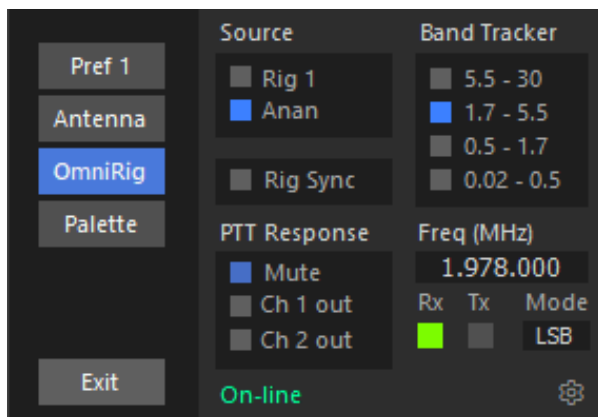

This example shows Rig 2 selected, renamed here as Anan 100, and it's in receive mode on 1.978 MHz LSB. Mute is selected so that Aziloop will go into Mute mode when the Anan 100 transmits.

Band Tracker is set to auto-insert the 1.7 to 5.5 MHz filter when in-band. (Multiple filters can be selected).

Source

The two source options correspond to the Rig 1 and Rig 2 sources in Omni-Rig's own setup panel. These can be re-named in Aziloop:

Re-naming the source

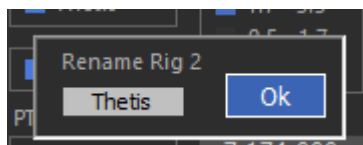

Right click the name and change as required then press 'Ok'.

Omni-Rig settings



Pressing the cogwheel (bottom right of the Omni-Rig panel) brings up the standard VE3NEA Omni-Rig setup screen (which, as it's outside the control of Aziloop, may appear on another screen in multi-screen setups).

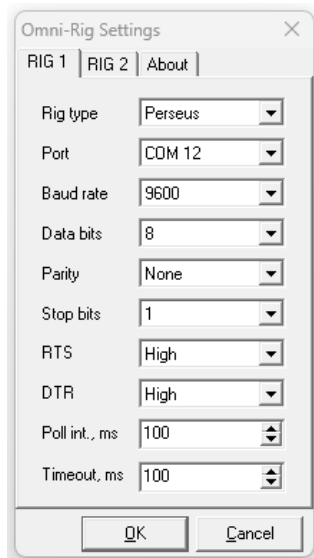

If you have a receiver or transceiver working with Omni-Rig already, Aziloop's Omni-Rig features should 'just work'. There is plenty of Omni-Rig setup help available including YouTube videos.

Note: make sure the Poll interval and the Timeout are set to the minimum of 100 ms.



Omni-Rig Status messages



Activity Indicator

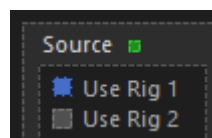

A small green activity indicator will momentarily appear each time Aziloop receives and makes use of incoming Omni-Rig data.

4.3.1 Rig Sync

Rig Sync keeps the frequency and mode of two rigs in track. This is particularly useful if you use a remote receiver and local transmitter, or a separate local receiver to your transmitter. Operation differs depending on what mode Aziloop is set to.

Local / Local Demo mode

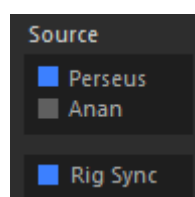

With Rig Sync active, the selected rig is in control. In this example a change in Perseus frequency or mode will be transferred to Anan. Anan changes won't be sent to Perseus.

Server / Server Demo mode

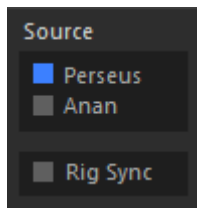

Rig Sync is not available at the server end. After a mode change to Server or Server Demo from another mode, Rig Sync is cancelled if previously set. Rig Sync is initiated by the client.

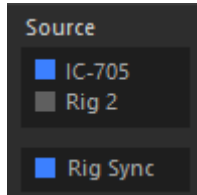

At the client end, Rig Sync can be enabled. In this example IC-705 frequency and mode changes are transferred to the Perseus at the Server end – see above.

Remote Receiver Calibration

On most rigs, the RIT control will be detected by Omni-Rig and added to the main receive frequency. This means that using Rig Sync a client's transceiver RIT can in effect calibrate the remote receiver's frequency (which may vary with changes in temperature at outdoor sites). Note the RIT offset will stay constant unless adjusted, whereas any remote receiver frequency error will increase with frequency so you may need to re-adjust the RIT after a band change.

4.3.2 Band Tracker

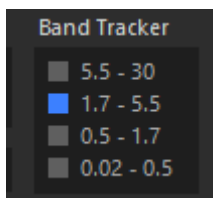

With Omni-Rig monitoring frequency, you can enable any combination of roofing filters in the LCU. They are auto inserted when the receiver is within that band. The best filter fit is chosen for each selection.

4.3.3 PTT Response

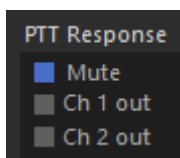

When a PTT action is detected via Omni-Rig you can select Mute or choose to activate Channel 1* and/or Channel 2* in any combination.

* You must set the Main Aux I/O channel setting(s) to Control.

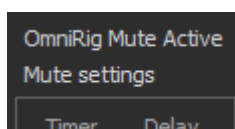

When Mute is chosen, this is indicated in the Aux I/O setup panel, and the Mute settings are enabled.

4.4 Preferences - Palette

As well as providing a means to select a pre-existing palette from the dropdown list you can also edit an existing palette or create a new one by saving the changes under another name. You could for instance alter colours to match your preferred SDR receiver app. We plan to make palette files available to match common SDR apps on our website.

Additionally, file management buttons provide full control over your palette list.

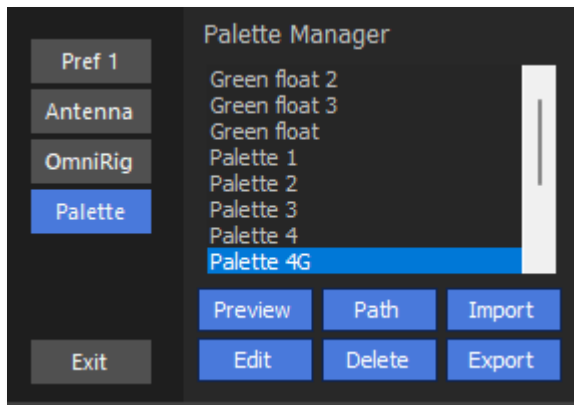

Note: The Palette option is not available while the app is in standby.

Edit – Change the colours

This option opens the Palette Editor (see next section).

Import – add more palettes

The main use for this option is to allow external palettes to be added. We may over time publish palettes that colour match popular apps. Additionally, this is a way to share custom palettes between users. Press 'Import' to bring up the standard Windows File Manager and select the file you wish to import.

Export – make copies of palettes

Exporting an .azi file allows you to make a backup copy of your latest creation or place a copy somewhere easy to find like your desktop to then send on to others.

Path – change the location where the palette files are kept

You can change the folder path used to store the .azi files. The default path on installation is shown below. A copy of all .azi files in the old folder will be copied to the new folder. Other file types that may exist in the old folder won't be copied. No files in the old folder are deleted. If you specify a new folder that doesn't exist, Aziloop will create it. Press browse to find another path or type in directly.

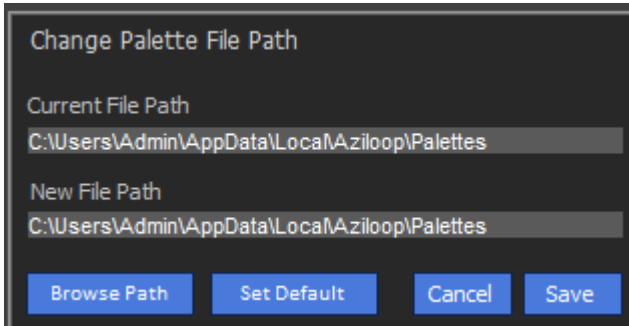

Set Default restores the path to the default created on first run, which is as shown here.

Delete a Palette.

Select 'Delete' to remove the highlighted .azi palette file. A final confirmation prevents inadvertent removal. Delete means delete. Files do not go to the recycle bin.

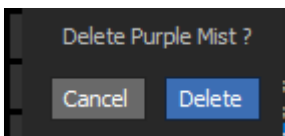

If you inadvertently delete all the .azi files from a folder, Aziloop will restart and put all the default installation .azi files back again.

Note: If you update the app with a new version you need to uninstall the old version first. This leaves the .azi palette files intact because the Windows Add/Remove Programs function doesn't know what palettes you created or where you put them. Should you wish to uninstall Aziloop completely you will need to manually remove the .azi files by deleting the ... \Aziloop\Palettes folders.

4.4.1 Palette Editor

Aziloop comes with several palette choices pre-installed, and Palette Manager is a feature you can ignore if you're happy with the default palette colours. But if you're feeling creative you can change the look of the app completely. Click through the other pre-installed palettes to see what we mean. Maybe you'd like to match Aziloop's colours to your favourite SDR app? You can even make panels and certain controls 'disappear' by matching foreground and background colours. If you just want to select a different colour palette from the list, click on the palette name then press Exit. As you select a new palette, the main app changes colour as a preview of what you've chosen.

Preview

Preview lets you visually check the palette file you selected is the one you want to use or to edit.

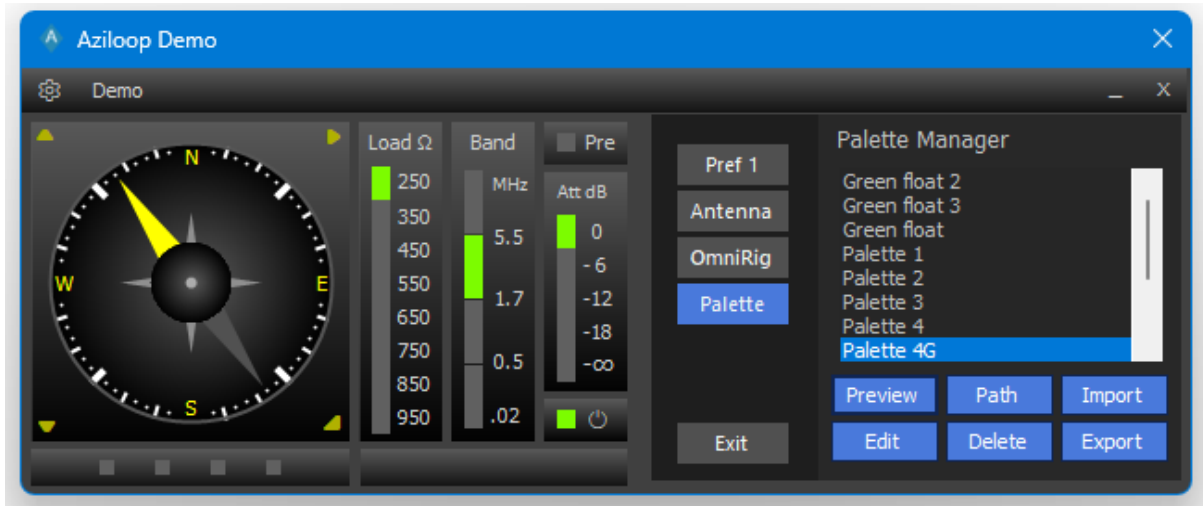

To open the Palette Editor, from Palette Manager select a palette (the active palette is highlighted in the palettes dropdown list) then press Edit. Select 'Purple Mist' which is a default palette added during installation.

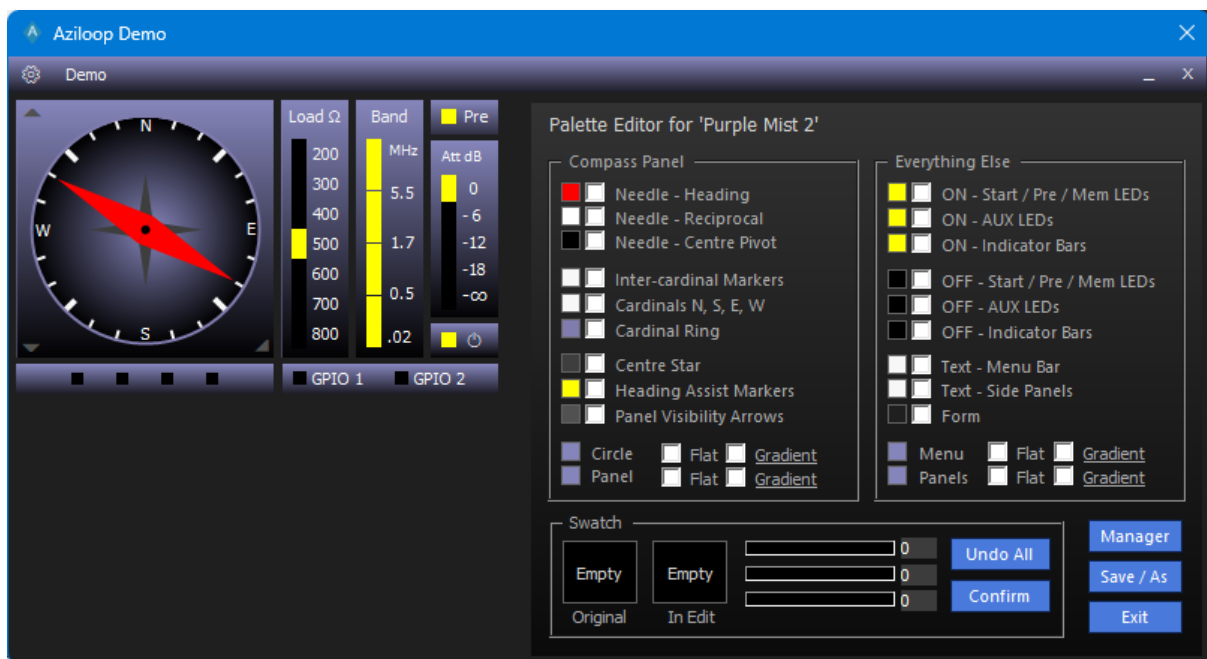

The Editor panel is not nearly as daunting as it first seems once you appreciate that the sub-panels marked 'Compass Panel' and 'Everything Else' together offer the same option 18 times plus 4 options underneath for defining background colours as flat or gradient (shaded). The 'Swatch' panel shows the colour that you are currently working with.

How it works

For each colour element available there is a mini-swatch showing the present colour, a tick box for selecting the element and a description e.g., 'Needle - Heading'.

Worked example:

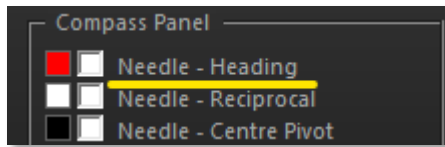

You can create a new colour or copy an existing one and use it unaltered or tweak it with the RGB sliders or numeric values. Let's say we want to change the needle heading colour from red to yellow.

We want to use the same yellow as the Heading Assist Markers, so we click that element to select it as the donor colour thus:

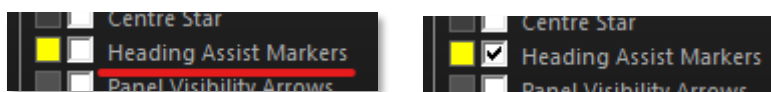

Notice that the main swatch panel now shows the donor colour.



Now we've selected a donor colour we can apply it to one or more colour elements as we wish. Tick Needle-Heading:

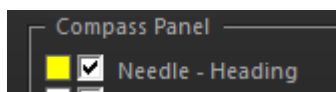

You will notice the compass needle immediately changes to yellow to reflect the change. Tick one or more other elements to see what happens. Untick them to cancel the change.

To cancel everything and go back to the original press 'Undo All'. If you are happy with the changes press 'Confirm'. Confirm won't alter things for good - nothing is stored until you save the new palette. But pressing Confirm holds the new colour changes and 'clears the decks' so you can make other colour changes in the same session without messing up what you've just done.

Create a new colour

If you alter the RGB sliders, you can vary the colour 'in Edit' and compare it to the original donor colour. Any ticked colour elements will vary accordingly. Press 'Confirm' to accept the change.

RGB Values



You can also directly enter RGB numeric values if you know the precise colour you want. Just click the numbers next to the sliders and change as required.

Greyscale



Right click and drag any of the three RGB sliders. All three colours adopt the same value and then change together to produce any greyscale shade required. (Left click and drag just changes the target slider alone)

The 'Flat' / 'Gradient' Option



This option allows you to alter the background colours from flat to gradient (shaded). The underlined labels denote the current setting. As described above, select a donor shading and apply it to other elements or alter the colour with the RGB sliders. Note you can't apply shaded colours to smaller elements such as compass pointer.

In the example we are using, selecting 'Gradient' or 'Flat' for the 'Circle' element produces this:

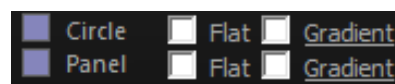

The current setting, 'Gradient' is underlined.

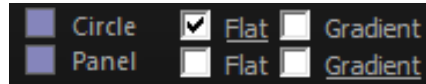

Click 'Flat' and note the change.

Saving the new Palette

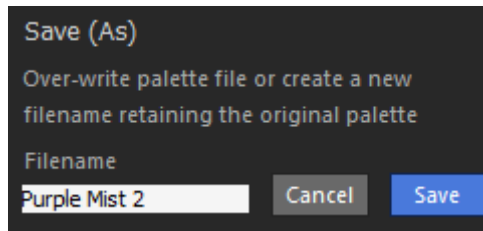
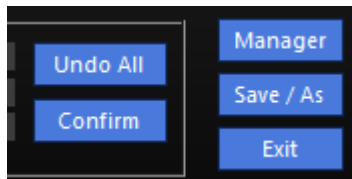

You don't need to press 'confirm' before saving a palette – the action of saving it implies confirmation. Press Save / As to open a panel that allows you to overwrite the existing 'donor' palette, or if you type in a new name, you can create a new file leaving the original unchanged. Palette files are small text files with the file-type extension *.azi. Press 'Path' in the Palette sub-menu to find out where they are.

'Manager' takes you back to the Palette panel showing the list of palettes.

Press 'Exit' to abandon any changes and cancel all Palette operations.

Colour matching

To match Aziloo's colours to say your favourite SDR program, a colour picker can be especially useful. Many free colour pickers are available for download, for instance 'Instant Eyedropper'. They all let you hover over a colour anywhere on your screen and capture the RGB value.

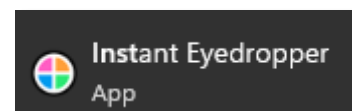

If you're feeling creative, you can colour match any SDR app.

4.5 Preferences – ‘...’

The final Preferences option is a new addition that essentially opens a second set of Preference choices. These have their own selection panel to reduce clutter in the main Preferences panel.

Currently there is only one feature, but more will be added very soon. All have been developed in response to user requests and may not have happened otherwise. Please get in touch if there's a new feature you'd like to see, though we can't guarantee to act on every suggestion.

4.5.1 Azi-Auto

Purpose

Azi-Auto is a feature that allows automatic time-based switching of things like heading, filter state, preamp etc. Currently there are up to 4 definable switch events. When the time reaches the 'Active From' time, the change occurs. Data is taken from the four memories of the memory panel (located below the Compass panel).



Memory panel below Compass.

Note: Dot visible when Azi-Auto enabled

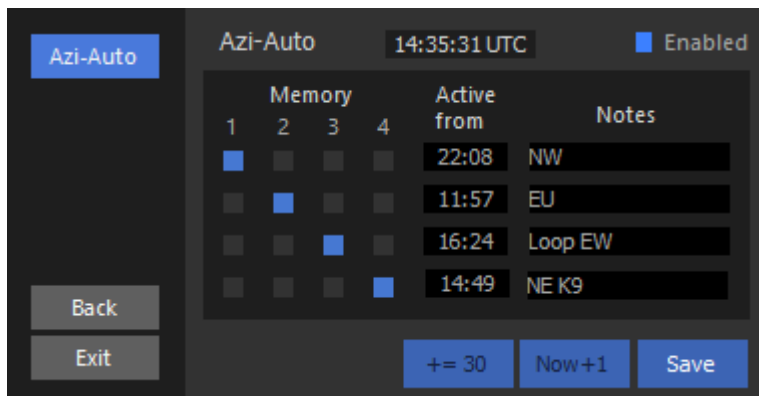

Memory

Each row can be set to recall the stored settings from any of the four memories, in any order, and repeatable if needed.

In the example above, row 1 will activate the state stored in Memory 1 at 22:08, row 2 will activate Memory 2 at 11:57 and so on. The activation times do not have to be consecutive and can be as little as one minute apart.

To work, the 'Enabled' LED needs to be lit, which also lights a 'dot' in the memory panel.

Active From

To set this time, click the text box, which changes colour, also enabling the +=30 and Now+1 buttons

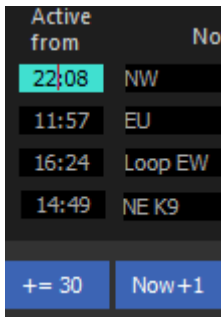

You can enter a time by direct entry, or by clicking the time insert buttons.

Now+1: Add 1 minute to the system time once only.

+=30: Add 30 minutes to the system time per press.

Now+1 is a convenient way of selecting the earliest possible switch time, mainly for testing.

System Time

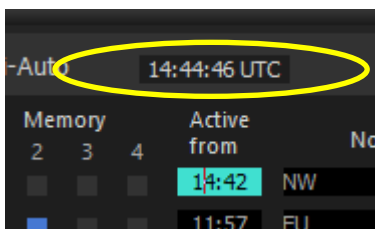

This can be displayed as UTC or local clock time. Change by clicking the text box.

Note: Decide on which time reference you wish to use before setting the trigger (Active from) times as they will not adjust themselves accordingly.

Notes

Freeform area for you to identify each change. This is not linked to the normal Memory names.

Save

All changes are saved on exit but to stay in the panel and move to another panel after a manual time entry, press Save.

Aux I/O

The Aux I/O state stored in each memory can be used to trigger an I/O change.

Make sure Preferences>Pref 1>Memories: Aux I/O is enabled, and that the I/O channels to be used are set to 'Control'. You can set one channel to Control and the other to say PTT in and have dual use.

Note the Azi-Auto feature is quite new and may require further refinement.

5.0 REMOTE OPERATION

You can skip this section entirely for single site installations using a USB connection to the CIU.

Introduction

The Aziloop app has built-in Client Server capability. The same app covers both modes along with local control. You will need a PC at both ends of the link, one to run an instance of Aziloop as a client, and one to run an instance of Aziloop as a server. All the Aziloop hardware (CIU, LCU, antenna) is installed at the server end. No hardware is required at the client end.

Additionally, the CIU has a built in Ethernet server so that you can operate Aziloop remotely without a PC at the antenna end, or you may choose to operate on your local LAN in the same way. This option is especially convenient if you sometimes operate locally and sometimes remotely where no further configuration is required when changing your location.

The PC server setup is very straightforward. There are only two things to adjust, and these can be left with their default settings. You will however need to add a port forwarding entry to your router so that client data can reach the server. The client setup requires just more step. As well as the same port forwarding requirement, you will need to know the IP address of the server. You can configure up to five remote servers and choose between them.

The following sections cover client server setup in detail.

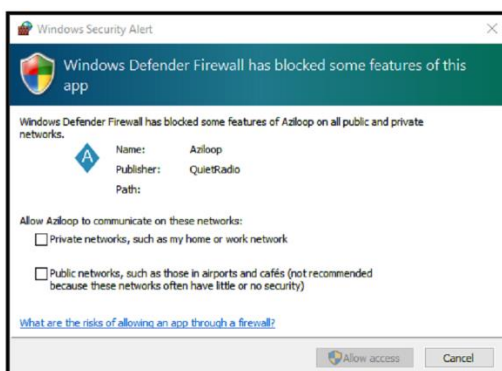

Note: This popup may appear minimised, the only indication being an additional icon in the task bar (that may be flashing).

If Windows Defender is active on your PC, you will see a firewall exception appear the first time you run Client or Server mode. You need to allow access for the link to work.

If you are running more than one Ethernet adapter, see [Server Setup Panel](#) below.

5.1 PC Server / PC Server Demo Mode

Configuring the app as a remote server with hardware connected, or in Demo mode (without hardware connected) is the same. However, in **Demo mode** the Aux setting is simulated as 'Control' on both channels because there is no CIU present.

To operate Aziloop remotely, the copy of the Aziloop app running on a PC at the antenna end needs to be set to Server mode, and the app running at the Client end (where you will be) needs to be set to Client mode.

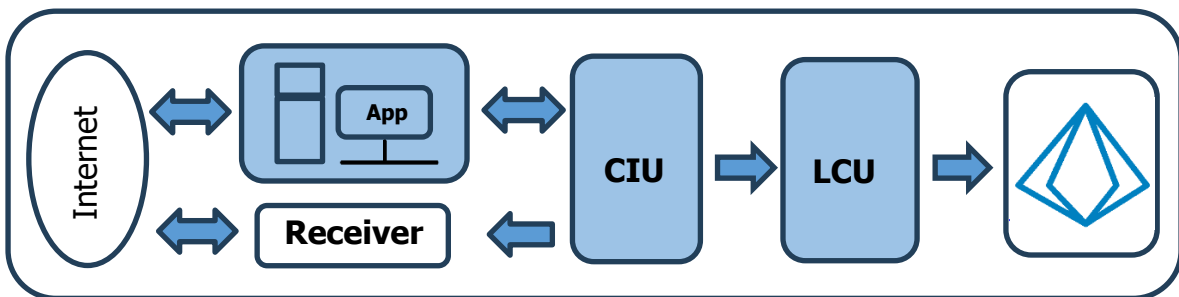

If the mode displayed on the Title bar isn't Server or Server Demo (where no hardware is required), select Settings > Mode then choose Server or Server Demo. Then press Confirm.

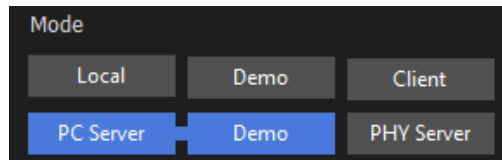
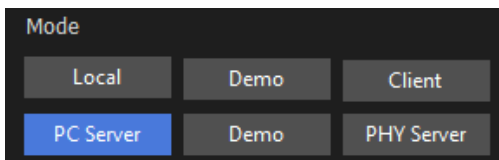

PC Server setup

Once in Server or Server Demo mode, the Server Setup option becomes available in Settings.

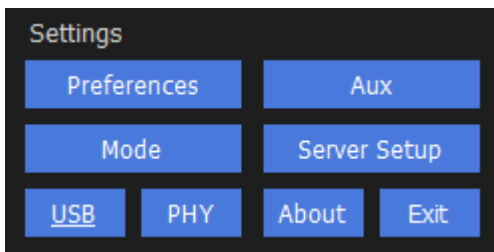

Select 'Server Setup'.

Server Setup Panel

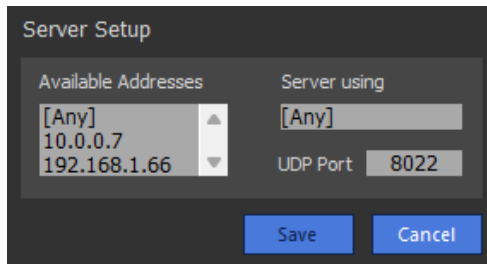

Save is activated if changes are made.

Multiple Address Handling

This panel lists the available Ethernet adapters. In most cases only one will be listed unless you are also using a VPN (as illustrated above). Be aware if a destination has two routes, VPN and non-VPN, the VPN route may always take precedence depending on your VPN settings and Ethernet adapter metrics.

The IP addresses available are outside the control of the Aziloop app, but you'll need to know the one(s) in use for configuring the port forwarding on your router.

Server using

To change the active address, select one from the list. The server will only respond to data on the 'Server using' address.

UDP Port

In most situations you can leave the port as 8022 unless there's a clash with something else, but make sure the same value is used at the client end.

DHCP (Dynamic Host Configuration Protocol)

Generally, routers will dynamically allocate an IP address to a host with a particular MAC address then maintain that relationship. But this cannot be assumed, and it's better to change the server PC's IP address to a fixed value.

- On a Windows 11 machine, go to Settings > Network & Internet and select Ethernet, then press Edit next to the IP assignment row.
- Change to 'Manual' in 'Edit IP settings', enable the IP4 slider and fill in the fields as required.

Server Polled Indication

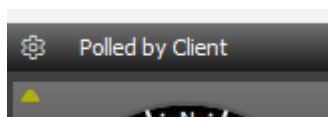

When a client sends a poll to the server (when the Server Selector is opened, or refreshed), at the Server end a 'Polled by Client' message pops up in the Menu bar.

5.2 Configuring the CIU Server

The DF-X CIU includes a built-in Ethernet PHY (Physical interface) and UDP server. Many SDRs now have built-in servers, for instance Kiwi-SD. Using CIU Server mode simplifies the requirement at a remote site as long as the server's IP address is reachable. Local LAN connections are of course also possible.

The Ethernet speeds available are 10 Mbps or 100 Mbps. If you use a router or switch capable of higher speeds, make sure it can rate-adapt accordingly. This is normally a given.

Once set up in CIU Server mode, the CIU runs on its own with just the 13.8 V supply and when enabled will auto-start when power is applied. The LEDs on the RJ45 socket will not light with the cable unplugged even if CIU is powered. The red status LED may not be lit.

Note: when the CIU Server is powered the CIU enclosure may become slightly warm after a while due to the extra current through the 5 V regulator.

Entering the Setup panel

The CIU Server settings are changed from the PC app via Settings:

- Make sure the USB cable is connected.
- Select CIU Server from the Settings panel. The text is underlined when the CIU Server is powered.

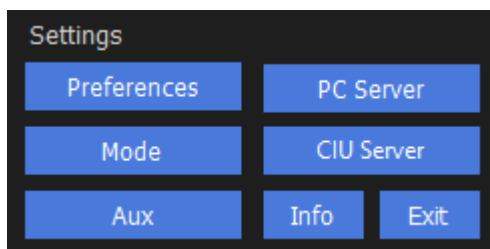

CIU Server can run alongside any mode running in the app itself. Once CIU Server is configured, the local PC can be disconnected.

The CIU Server operates in parallel with the PC app on a logical OR basis. Data from either is accepted by the CIU circuits. Note however that each is unaware of changes made by the other, so UI displays may become out-of-date if the other control method was the one last used.

Powering up the CIU Server

Press 'Powered', wait a few seconds then press Refresh. The RJ45 LEDs should now be lit.

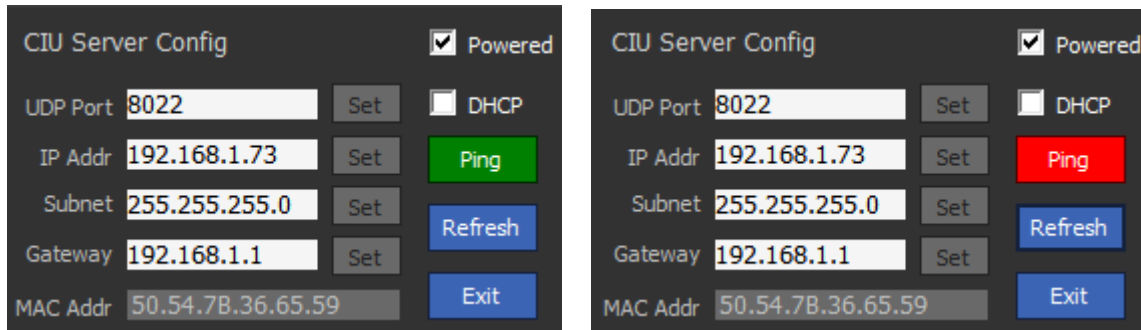

Pinging the connection

With the CIU Server powered and the parameter boxes populated, press 'Ping' to check the IP address is reachable. Green indicates a successful test.

Changing the settings

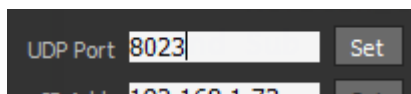

Click inside a textbox and edit as required, then press the 'Set' button alongside, which becomes active when the textbox is clicked. Wait until the 'Ethernet port (as UDP Server)' title re-appears then you can press 'Refresh' to read-back the settings. Press 'Ping' to check the connection is working. You may need to unplug/wait a few seconds /re-attach the RJ45 depending on how your router handles the changes against the same MAC address.

UDP Port

The rule still stands that the client and server need to use the same UDP port for a connection to work, but the port used by the CIU Server can be different from that used by the PC server. This may be preferable to ease port forwarding setups. Note the Client app can only use one port number for all servers in its list.

DHCP (Dynamic Host Configuration Protocol)

We recommend using a fixed IP address though many routers will initially allocate a random IP address and lock it against the MAC address, but this cannot be relied upon.

If you want to use a fixed IP address that isn't in use, you could select DHCP to let the router allocate an address, then change to fixed IP using the same address.

Note: Currently the DHCP state is assumed from a stored setting in the app and is not updated from the CIU. If you are unsure, cycle the option to re-sync.

Once enabled, the CIU Server will run regardless of the app's operating mode and will auto-restart whenever the 13.8 V supply is present. It is a separate entity from the PC app and once set up, the USB cable can be unplugged (though you will of course need that connection to change any CIU Server settings).

Testing

Change the Aziloop app to Client mode, add your CIU Server details to the Remote Servers list in the Server Selector panel, and if CIU Server is powered it should be available to connect to over your LAN.

If you wish you can now unplug the USB cable as this isn't required by the app in Client mode.

CIU Server Powered Advisory

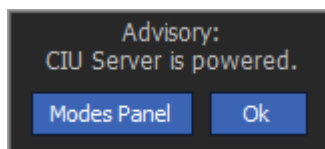

On first powerup, if the CIU Server is enabled, an advisory panel pops up as a reminder.

Omni-Rig not possible via CIU Server

There is no remote Omni-Rig capability when using CIU Server as Omni-Rig needs the Omni-Rig PC app.

5.3 Configuring Client Mode

If you only intend to use Aziloop locally via USB, then this section can be ignored.

To operate Aziloop remotely, the app running at the server (receiver end) needs to be set up in Server mode, and the app running at the client end (where you will be) needs to be set up in Client mode.

At the client end, just a PC running the app, and an internet connection to the server is all that's needed.

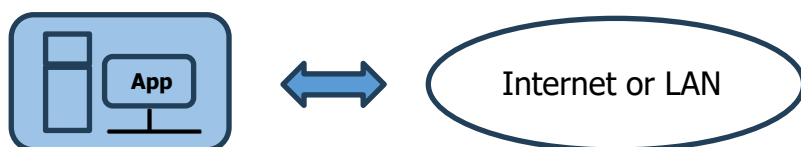

Client setup summary

If you leave the UDP port number as 8022 at both ends, and you know the IP address of the Server, then all you need do is create a new entry in the Client-side Server Selector panel (shown below). For normal IP addressing (non-VPN) you will also need to alter the port forwarding settings of your router to make sure data from the server is directed to your PC.

Make sure the app is running in Client mode, then open the Server Selector via Settings > Remote Server:

Selecting Client mode

If the mode displayed on the Title bar isn't Client, press Settings > Mode, select Client then Confirm.

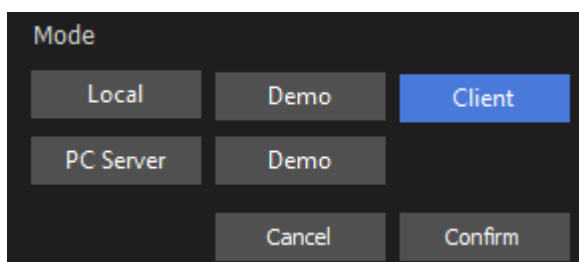

5.3.1 Server Selector Panel

The Server Selector panel is where you add entries for each remote server, set the global port number the system uses throughout, and change any preferences.

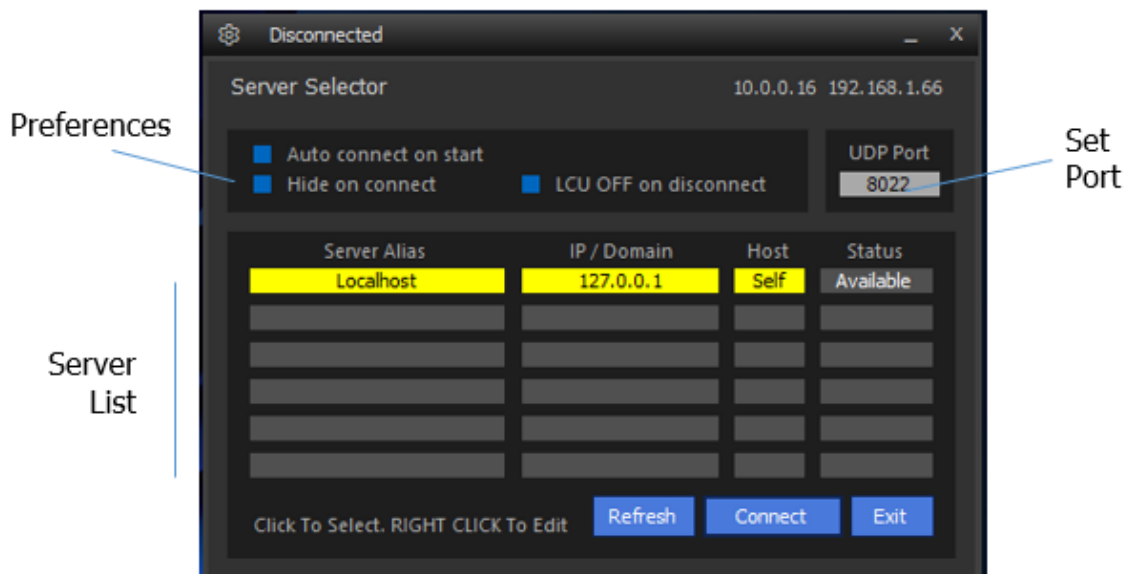

At the top right is a list of IP addresses for the Ethernet adapters running on your PC. You'll use the addresses to set port forwarding in your router so that data from the Server is directed to your client PC (unless Client and Server are on the same LAN or you use a VPN). There are rows for up to 5 more servers in addition to the default 'local host' server on IP address 127.0.0.1 which is always present.

If a server is reachable via two addresses, only include one in the list. The server will only use the first address it receives a poll on. Try restarting the server if no response is received on a known good link.

Localhost entry on Row 1

This row serves as a confidence check and is not editable. The Status should always indicate 'Available'. You can connect to this server with no setup required, to familiarise yourself with Client operation. Note that Windows 'localhost' is not a check of the physical Ethernet cable and associated network – the loopback is handled internally in the PC and no data appears on the Ethernet cable, but it does confirm that the internal IP stack is functional.

Server Alias

This is just a free-form field to enter a name that means something to you. It's not used by the app.

IP / Domain

Enter the server's IP address or domain name in this column. A Dynamic DNS service such as No-IP can be used for sites that don't have a fixed IP Address. Many routers have a built-in DDNS option with a choice of providers, otherwise you can run a background task on your PC that reports IP changes to the DDNS host of your choice. See your DDNS provider's website for details.

Finding a domain's IP address

If you use a domain name, you can find out the IP address it resolves to by hovering the mouse over the entry:

Server Alias	IP / Domain	Host	Status
Localhost	127.0.0.1	Self	Available
Test Server	████████.ddns.net	PC	Offline

Server Alias	IP / Domain	Host	Status
Localhost	127.0.0.1	Self	Available
Test Server	90.248.████████	PC	Offline

Host (PC or CIU)

This column indicates whether the server is a PC running the Aziloop app, or a CIU is using its own Ethernet server with no PC connection required (once configured). When the server responds as a CIU Server, the 'PC' text changes automatically to 'CIU'.

Status

This is a read-only field. There are three states reported:

- **Available:** Server can be reached and has returned a poll response.
- **Connected:** Client is currently connected to that server.
- **Offline:** No poll response from the server. Domain names that do not resolve to a valid IP address are also reported as Offline.

Refresh button

If you've changed the network configuration outside of the app, press Refresh to re-poll the Servers. A refresh also happens automatically after any Server Selector edits, and when the panel is first opened.

Changing the UDP Port Number

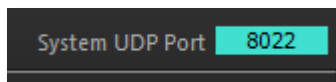

Right click to Edit, make any changes, then right click again to Save.

Any number up to 65535 can be entered but avoid numbers already in use and make sure the server uses the same port. The port number is global (used in all server entries).

Deleting a server

Right click a row to enter Edit mode, then double (left) click the row to delete.

Leaving Edit mode

Right click again i.e. Right click toggles Edit mode.

Client preferences

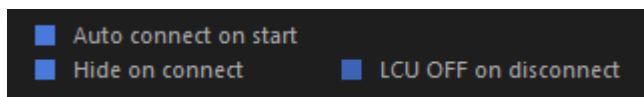

Client preferences summary	
Auto connect on start	Attempt to auto-connect to default server when start button pressed
LCU OFF on disconnect	Remove power from remote LCU when link disconnected.
Hide on connect	Auto close the Server Selector panel after a successful connection to the target server.

Auto Connect on Start

A link to the default server is automatically attempted when the 'On' button is pressed. Without this option enabled the Server Selector panel appears first for you to manually choose a server. If you only use one server there is no need to select it every time.

LCU OFF on Disconnect

This option gives the Client a choice of whether to power down the Server LCU at the end of a session. The remote receiver is also isolated (CIU attenuator placed in 'infinity' mode, and of course power consumption is reduced. The purpose of the connection may be to adjust a setting then disconnect again, in which case retaining power is clearly the choice. In cold climates maintaining power may produce more reliable operation by keeping the circuitry warm, and similarly in very hot climates

long term reliability may be improved by removing power between sessions. We don't have any reports of climate related failures, these are just common-sense suggestions.

Note: When a new remote connection is made the LCU always powers up (or appears to if the remote server's mode is Server_Demo).

Hide on Connect

Once an available server is chosen and a successful connection established this setting automatically closes the Server Selector panel. If the connection fails, the panel stays in view.

Client Start Stop



The power button on the Levels panel functions as the Connect button in Client mode. The power icon is replaced by a link icon. You can also disconnect from the Server Selector panel.

Click the button to close an existing connection. Clicking when disconnected causes the Server Selector panel to appear, or if Auto connect on start is enabled, the link is started automatically.

Connect / Disconnect button

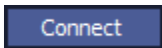

The button is enabled when the selected server status is 'Available'.

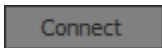

If the target server is offline you can't attempt a connection.

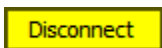

After a successful connect, press to disconnect.

Exit button

Closes the Client panel and returns control to the main app.

Am I connected?

As well as the Status field of the Server Selector, the Aziloop Menu Bar also shows 'Connected' when connected.



What am I connected to?

Hover the mouse over the 'Connected' label on the Menu bar. Round trip information is the total time for a Client command to travel from the Client PC to the Server PC and back again including local processing time at each end. It's not a 'ping' value.

Note: The round-trip data only becomes valid after 10 commands have been sent and is not available when connected to Localhost. The app needs to have focus for hover to work.

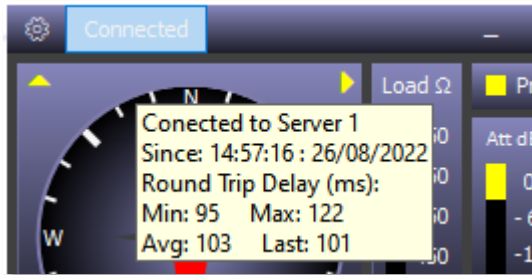

Fully automating operation with a single Server

If you have a single server or preferred server, you can automatically connect to it when the Aziloo app is loaded.

Make sure the target server is highlighted in yellow in the Server Selector panel then enable these options:

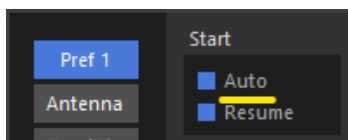
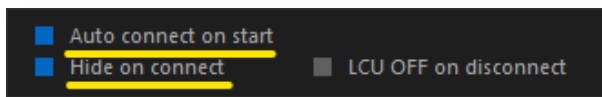

Additionally, make sure Auto is selected in the Pref 1 settings.

So, when the app starts it sees the Auto start setting in Pref 1, after which in Client mode the Server Selector would open. However as Auto connect on start is enabled, the app automatically attempts to connect to the default server (the server row highlighted in yellow). If the connection fails, the app falls back to showing the Server Selector panel for user intervention.

Remotely control LCU power - LCU OFF on disconnect

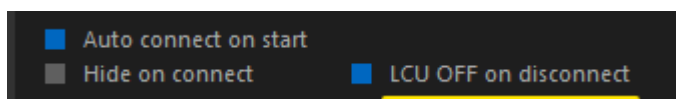

Options in Server Selector

This allows a client to decide whether the LCU at the server end stays powered up after a link disconnection.

6.0 INSTALLATION

What's shipped in the box?



The following items are supplied along with the CIU and LCU units:

- 2 x pole mount adapters for the LCU
- 4 x cable ties for attaching the LCU
- 1 x spare M2.5 LCU lid screw (when available)
- 2.1mm barrel to bare end cable for 13.8 V DC supply.
- USB mini to USB type A cable
- 3.5mm stereo plug to phono cable (for AUX I/O)
- 2 x SMA to BNC female adapters
- 4 x feet for attaching under CIU (pre-fitted ones are known to move in transit)

6.1 Installation - Software

Officially we support Windows 10 and Windows 11. CPU load is very small so any PC that can run under Windows 10 or 11 should work. Windows 7 has also been shown to work but we don't officially support it because Microsoft no longer do. **Note:** see dependencies below if you are using Windows 10 or older.

Note: If you are updating an installed version of Aziloop DF-72 you will need to uninstall it first. If you don't, the installer will prompt you anyway.

You will have been sent an installation file or a link to one as part of the ordering process.

Some stages of the installation may take quite a few tens of seconds to complete so be patient. It depends on what system files you already have.

6.1.1 First Installation

Double click the .msi file in the Aziloop Installer.zip folder.

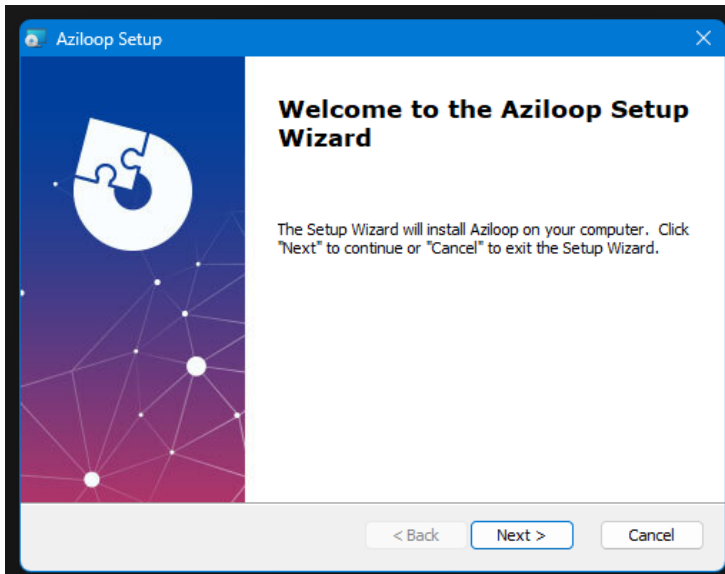

Press Next >

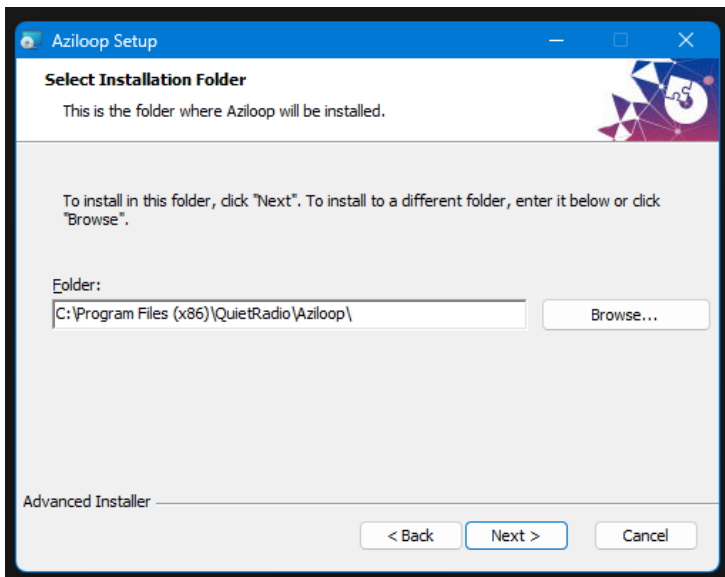

Press 'Browse...' if you want a different installation folder.

Press Next >

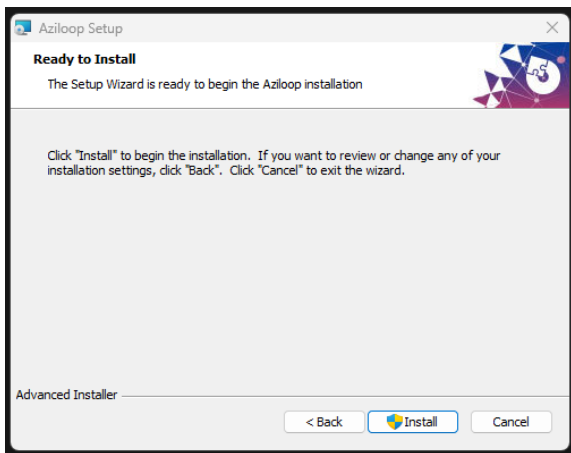

Press Install

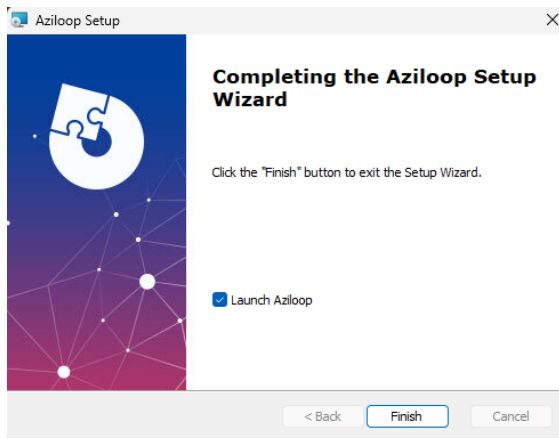
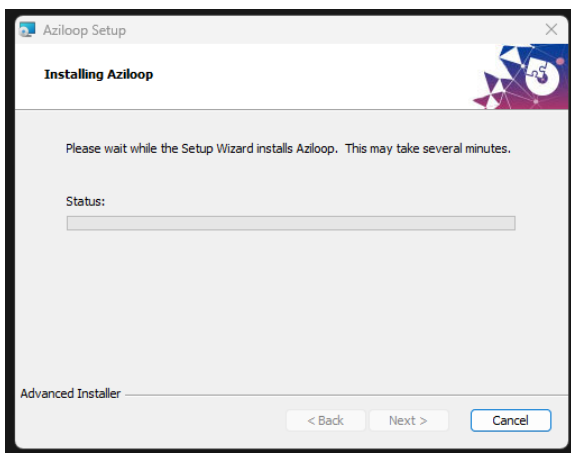

Tick launch Azilooop if you wish, then press Finish

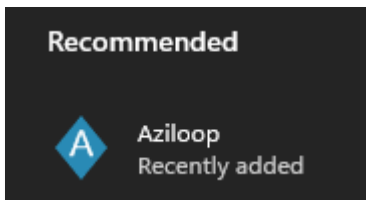

Once installation completes you should find an entry in the Windows Start Menu either visible or in the alphabetical list. and a desktop shortcut. You may wish to pin Azilooop to the task bar as well.

You can check for updates with the Info button in the App's Settings panel. The [Settings > Info](#) section covers updates in detail.

Dependencies – Windows 10 Font

Azilooop uses a Windows 11 TrueType (ttf) font called "Segoe Fluent Icons". This is absent in Windows 10 and older until you install it. You may have it installed already, and this can be checked in the Windows operating system, however it's probably easier to install the Azilooop software first, and if the cogwheel appears as a dot, then install the extra font as described below.

"What if I use Windows 10 and don't install the font?" Azilooop will still run but symbols such as the Settings cogwheel and panel selectors will appear as dots.

Adding the new font to Windows 10

Fortunately, this is an easy, one-time operation.

Included in the Aziloop_Installer.zip folder is a file called Segoe Fluent Icons.ttf. Double click it then select 'Install' from the top left of the window that appears. That's it – you're done.

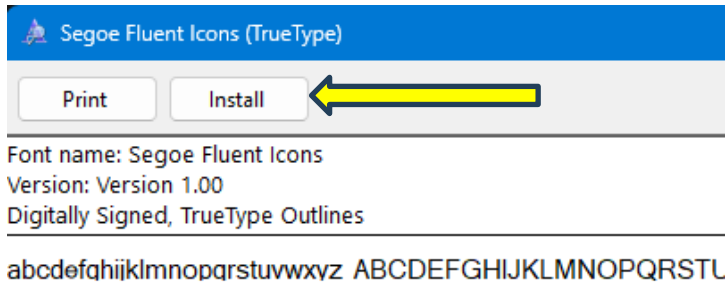

Uninstalling the Aziloop App

Find the Aziloop app in the Start menu, right click, then select Uninstall.

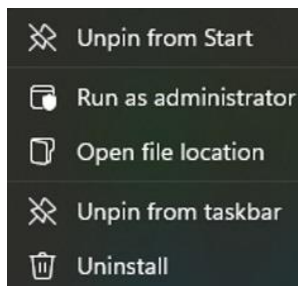

Windows 10 options may be different.

To install a new version, double click the new .msi to launch the installer.

Complete removal

For a complete removal you need to manually remove the files Windows doesn't know about (as the app installs them itself).

Go to your Appdata > Local folder and delete any QuietRadio or Aziloop folders, as Windows leaves these in place.

You can easily find this location from within Aziloop by examining the Path data in Preferences > Palette. It should start with C:\Users\ followed by your username (often Admin or default), then AppData\Local.

Note: Preferences > Palette is only enabled when Aziloop is active.

Note: If you have changed the Palette path you will have .azi files in that location as well.

6.1.2 Keeping up to date

To make sure you don't miss any updates, make sure Auto check for updates is enabled in the Update Manager panel. It's only really there to give you control over when Aziloop is accessing the internet.

Regardless of this setting, when you select Code Updates from the Info panel, the latest version numbers of the app and CIU firmware are accessed online and compared to those installed.

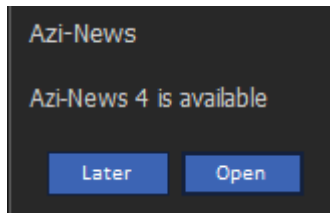

Azi-News

Newly added, Azi-News is an automatically downloaded pdf that can be accessed at any time.

Go to Settings, and click Info

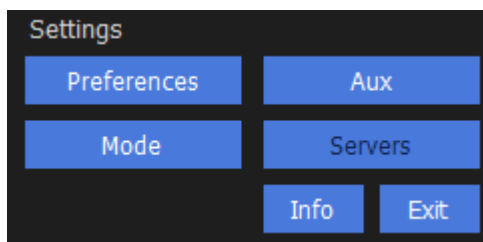

Then click the Azi-News button. The numerical suffix (4 in the example below) is an incremental index indicating the latest version.



The latest Azi-News pdf will be downloaded and displayed in your browser.

Azi-News Contents

The primary role of Azi-News is to act as a single document for notifying users of updates. It replaces the (i) buttons and release notes panel in the previous Update Manager.

Should any new products become available, they will also be announced here.

6.1.3 Update Manager - App Updates

When a new version is available the Download button will be enabled.

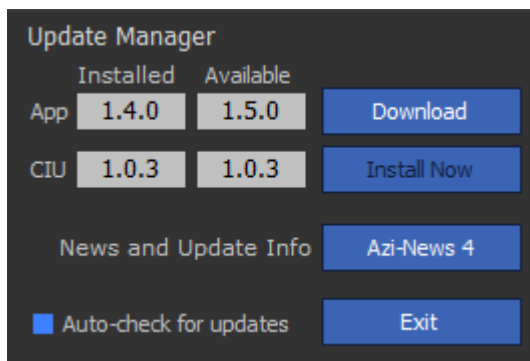

Click the Download button to download the installer file as announced by the next panel:

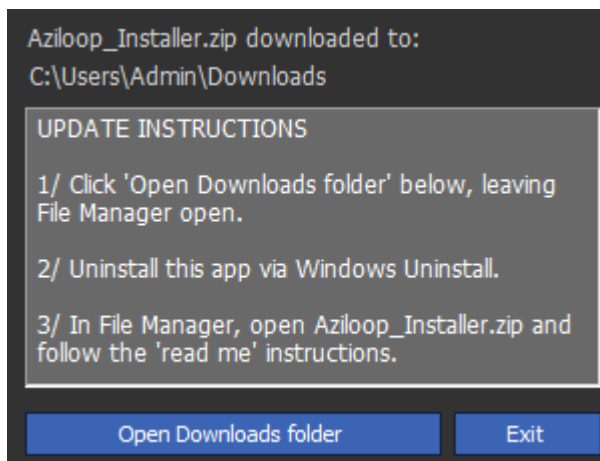

If you open the Downloads folder and keep it open in your PC, then once the current app is removed it's easy to find the file for the new one.

Perform the app update

After uninstalling the currently installed app, open the .zip file you downloaded and double click the .msi file, following the instructions as for previous installations.

6.2 Installation - CIU

If you haven't already installed the PC app, go to section 6.1.1 above first.

The app needs to establish control over the CIU via the USB interface. Complete the steps below before moving on to check the LCU.

6.2.1 First Installation

Preparation

- Install the app and check it runs ok in Demo mode – see [above](#).
- Disconnect the USB cable from the CIU if you've already attached it.
- You can leave the SMA ports unconnected for now.
- Make sure the 13.8 V supply is connected to the 2.1 mm barrel jack (Centre pin is positive). Use a good quality low noise DC supply. Linear supplies are preferred over SMPSUs.
- Watch for the red Status LED to slowly flash 'R' in Morse code as the 13.8 V is applied.

Assuming you are in Local Demo mode:

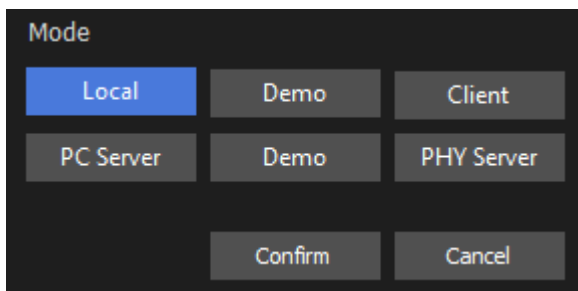

In Settings > Mode, set the mode to Local (with Demo un-selected) then press Confirm.

Automatic COMport setup

You will see this error message if the port is incorrect.

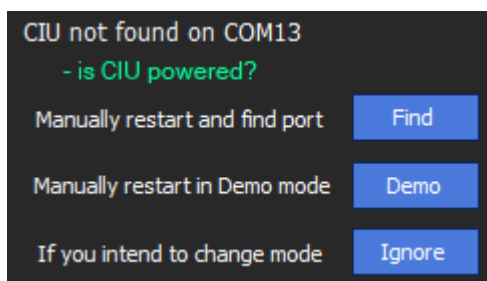

You can revert to Demo mode if you wish, otherwise select Find and restart the app then follow the instructions below. Ignore is useful if you intend to change mode to one not requiring the COMport such as Client mode.

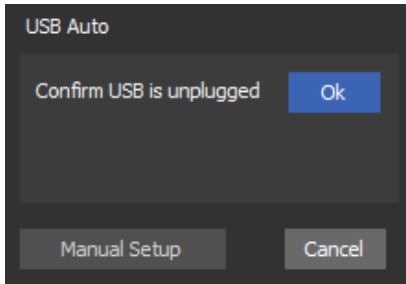

With the USB cable unplugged, press Ok.

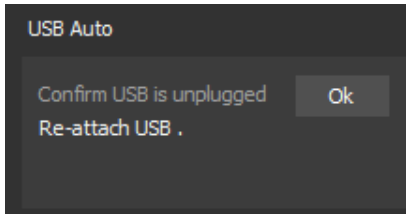

Plug in the USB cable.

The first time you attach the CIU, Windows may need to download a USB driver. A pop-up message will appear on the bottom right Taskbar area of your screen. Pause a few seconds and watch for this before continuing.

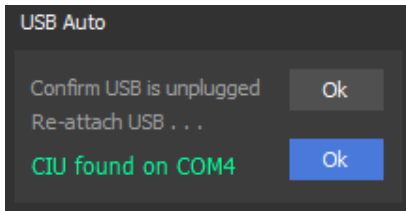

Aziloop should find the newly attached USB and report the port number. Press ok, and you're done. If you don't move USB cables around you may never need to change this again.

Manual COMport Setup

Manual selection may be the easiest option if you only already know the port, or if the automatic process fails (rare but not impossible). If you have lots of ports in use and regularly 'swap things about' Windows can get a bit mixed up. If all else fails, try a different physical USB port.

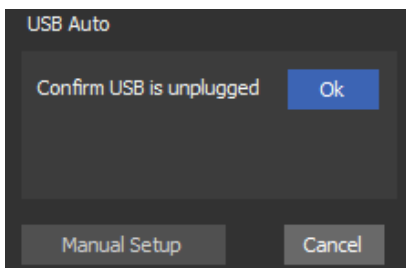

Follow the initial steps as above but this time Press Manual Setup.

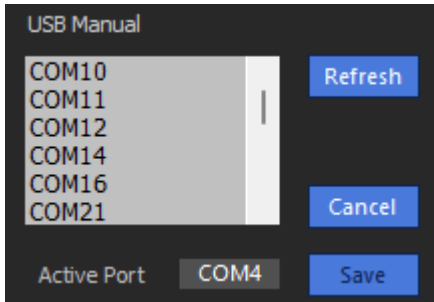

- Note the ports in the list.
- Plug in the CIU USB Cable.
- Press 'Refresh' again and note the additional port that appears.
- Highlight the additional port then press 'Save'.

“Auto Mode fails, and in manual setup I see some ports listed twice. What’s wrong?”

Windows USB handling is not fool-proof, and it’s possible there are multiple entries for the same port, and inactive ones are normally hidden.

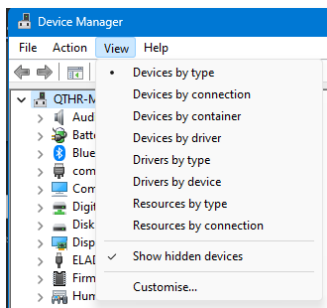

In Windows Device Manager, go to the Menu bar and select View. If 'Show Hidden Devices' isn't checked, click it.

Delete all the hidden COMports, making sure there is only one listing for each port overall, then retry.

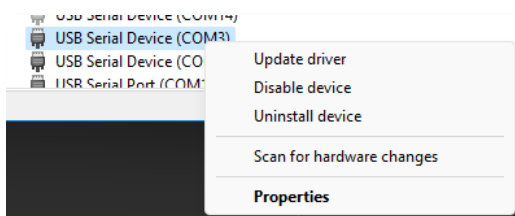

You can also go into the COMport properties in Device Manager and force a port to assume a different port number. Right click the port then select Properties > Port settings.

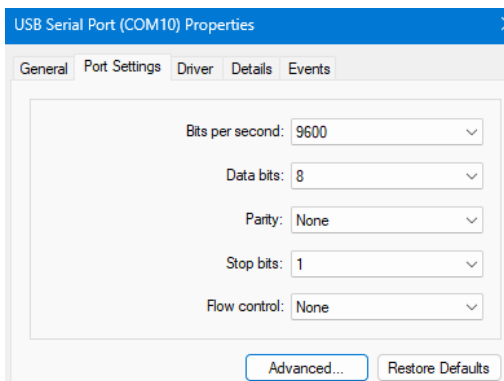

Click 'Advanced', change the port number then click 'OK'.

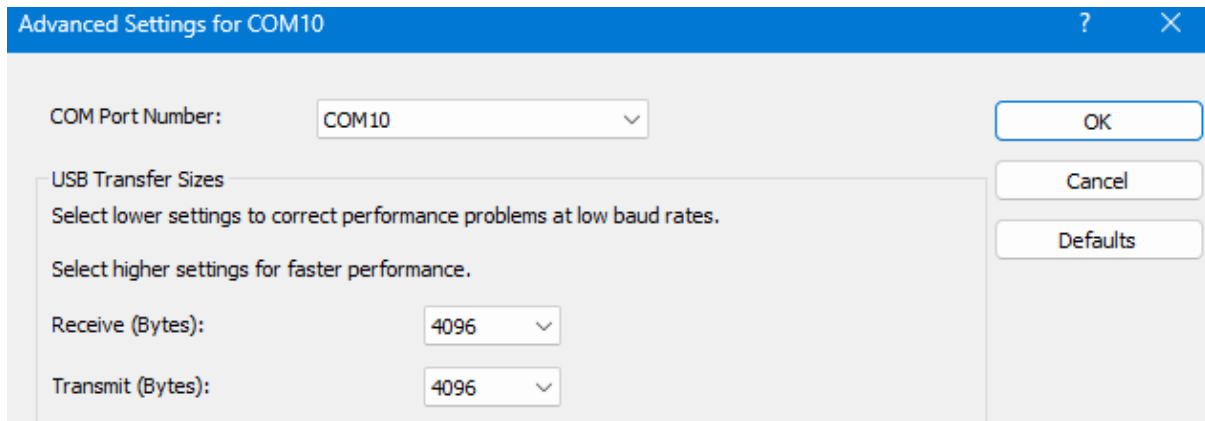

Third party COM port identifier

There is a third-party app (which we have no connection with) called Serial Port Notifier that we use extensively in the lab to immediately know what serial ports have been connected or disconnected. It's very handy to identify any USB change. At the time of writing, this link takes you to the app:

[Serial Port Notifier](#)

Once installed it runs as a background service. Whenever you plug or unplug a USB serial port a popup message appears identifying the port that's changed.

In-service USB port errors

If the CIU USB is inadvertently unplugged, the above port find procedure is triggered. Alternatively, you could find the unplugged cable and re-attach it. Then the restart should produce no errors. You could also try selecting Ignore then plugging the cable back in on the fly.

Normally, once you attach the CIU to a USB port, if you leave it there it will continue to work without any issues.

6.2.2 Keeping up to date

To make sure you don't miss any updates, make sure Auto check for updates is enabled in the Update Manager panel. It's only really there to give you control over when Aziloop is accessing the internet.

Regardless of this setting, when you select Code Updates from the Info panel, the latest version numbers of the app and CIU firmware are accessed online and compared to those installed.

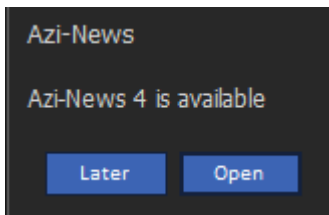

Azi-News

Newly added, Azি-News is an automatically downloaded pdf that can be accessed at any time.

Go to Settings, and click Info

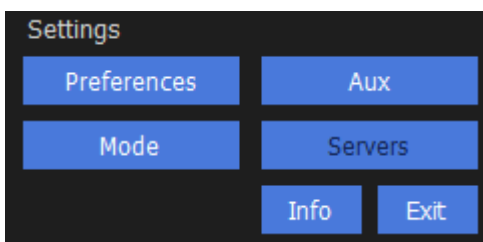

Then click the Azি-News button. The numerical suffix (4 in the example below) is an incremental index indicating the latest version.

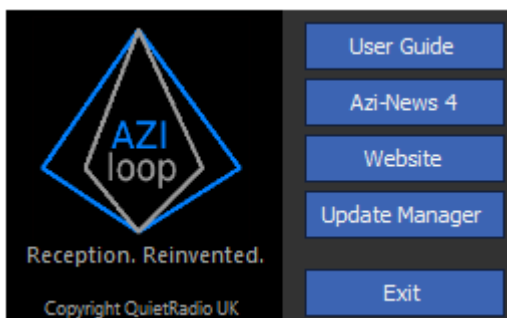

The latest Azি-News pdf will be downloaded and displayed in your browser.

Azi-News Contents

The primary role of Azি-News is to act as a single document for notifying users of updates. It replaces the previous (i) buttons and release notes panel in the previous Update Manager.

Any update announcements will carry instructions about how to perform the update along with details of the update itself.

If new products become available, they will also be announced here.

6.2.3 Update Manager – CIU Firmware

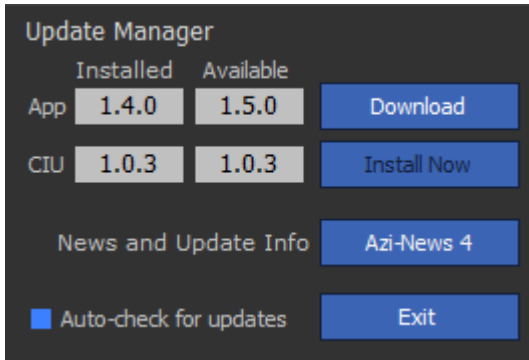

Updating the CIU Firmware

The CIU ships with firmware already installed, and updates are rare. However, the facility is there should the requirement arise.

Pre-requisites

The CIU Update button is only enabled when a newer version is available. Set the app to Local mode with USB connected (because comms to the CIU is required). Your PC must be connected to the internet (to get the updates), and the CIU 13.8 V supply must be present (to power the circuitry).

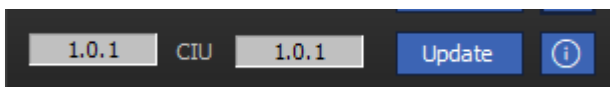

If enabled, click **Update**.

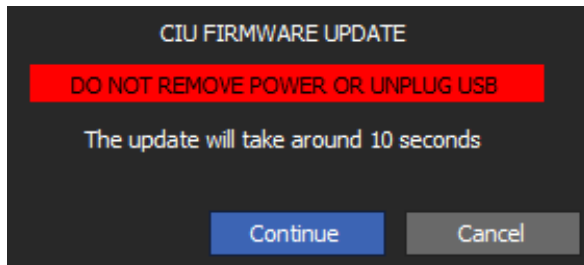

Two confirmation steps are required before the actual update begins. For the timid, there is a cancel button. For everyone else, press Continue.

If the CIU Server or LCU are active, they will be powered off once Continue is selected.

Caution:

You could 'brick' the CIU if you interrupt the update once in progress. Do not switch anything off or unplug the USB cable during the update - which only takes around 10 seconds. In practice updates have been 100% reliable. But there's always a first time hence our advice.

We use this method ourselves for programming the CIU during final commissioning, and we also ran a test of 1,500 consecutive updates overnight with no failures.

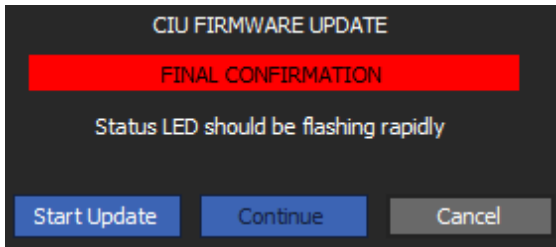

Ensure the Status LED on the CIU is flashing rapidly then press **Start Update**. The LED will flicker in a more random manner while the update takes place.

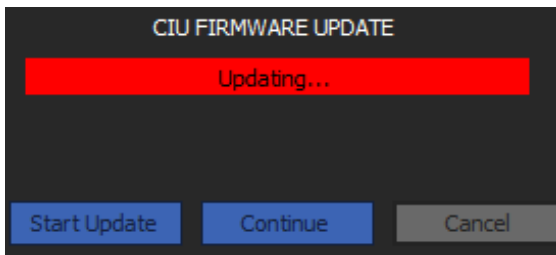

Update in progress.

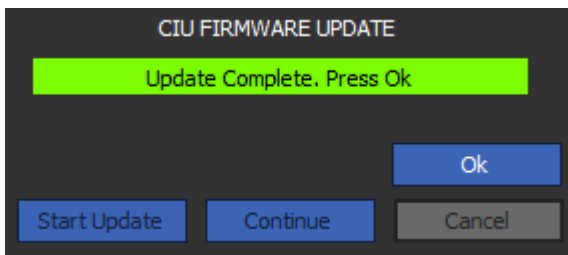

Update complete. Press Ok.

Upon restart, you may wish to re-visit Settings > About > Updates to check the installed firmware version has now been updated to the latest version. The 'Installed' and 'Latest' values should now be the same.

6.3 Installation - Antenna

The antenna and associated mounting hardware, feeder etc. are user choice and are currently not included in the Aziloop product.

Location, location, location

The loops should be placed as far as possible from surrounding wire and metallic objects. Large metallic objects nearby can produce directional errors or reduce nulls and front to back performance. You can only work with what you have of course, and compromises are inevitable.

Co-sited resonant antennas could affect performance by absorbing or re-radiating signals which can lead to azimuth errors. If you use Aziloop for receive with a larger antenna for transmit nearby, experiment with terminating the transmit antenna in different ways during reception. Try de-tuning a resonant antenna if you're receiving around the same frequency, or shorting out the feeder, or disconnecting it, or terminating it in 50Ω .

Generally, if you notice any interaction, then the antennas are too close, and the use of Aziloop's PTT mute option when transmitting is paramount.

Decisions, decisions

Do not get too stressed about what size antenna to build. The loops are un-tuned, so you don't need to tweak for resonance. The rule of thumb for small un-tuned broadband loops is to make sure the circumference is less than 0.1λ at the highest frequency of interest. You can make the loops smaller than the 0.1λ and they'll generally work fine albeit with reduced output level, which is proportional to the included area of the loop.

If you just want to get started with a tried and tested size, we suggest you try our recommended antenna dimensions below. All the antenna modelling plots are based on that antenna size, and we've built many to those dimensions.

In practice, for a given frequency at a given site with a given noise floor (either natural or man-made) there is an antenna size that picks up enough antenna noise for that to be the dominating noise source in the receive system, meaning the system is external noise limited. After that, increasing the antenna size merely degrades the receive system's dynamic range.

Without installing the antenna, you won't know the antenna noise level so a little trial and error may be needed. Bear in mind that the background noise level on the lower bands in the evening can increase by 10 dB or more.

Recommended Antenna size

As a starting point we suggest an antenna of the following dimensions for general use. Some users scale the antenna up when VLF/LF are their primary bands.

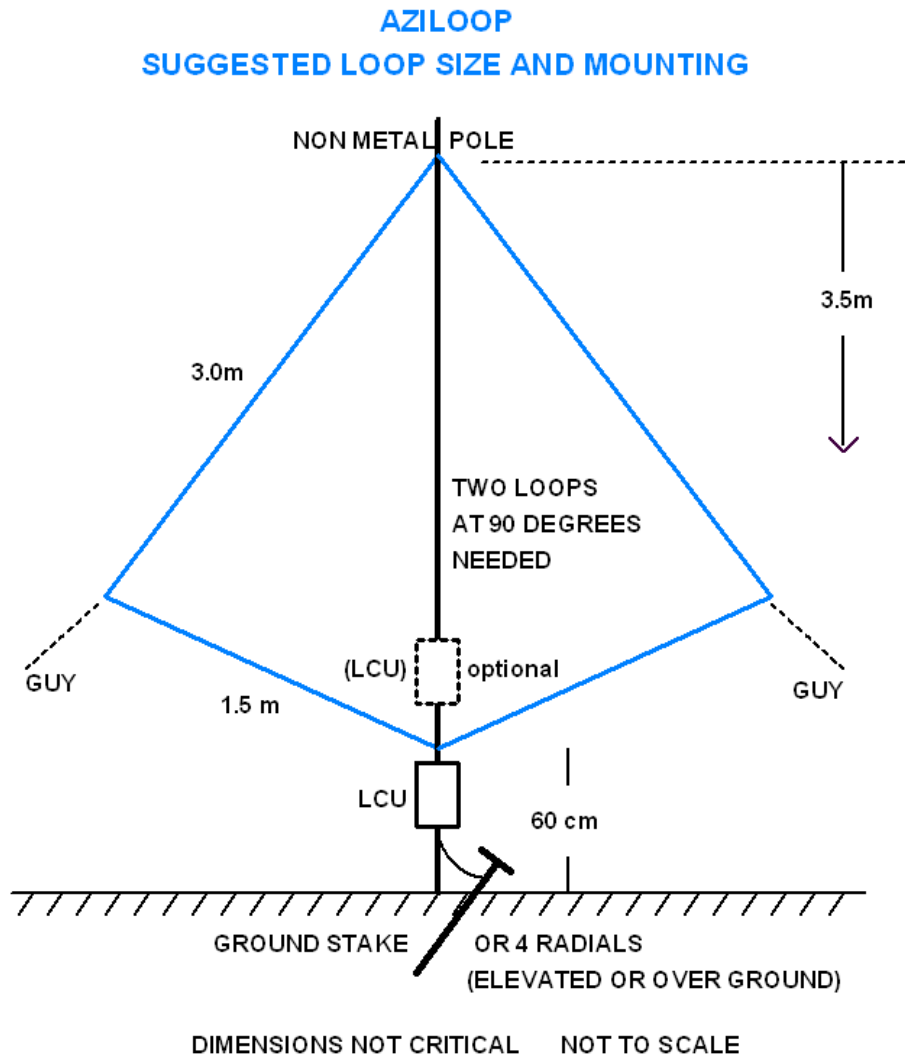

A single loop is shown. Install another identical loop orthogonally (at right angles). Orientate one loop to run north/south or failing that, offset by a multiple of 15 degrees and make allowances for the offset in Preferences > Antenna > click Antenna again. Do not change this setting after antenna installation unless you are re-aligning the loops.

Too small?

If you feel the dimensions are smaller than you feel comfortable with, increase the dimensions, keeping the shape broadly the same. Bear in mind this will limit the maximum frequency for correct K9AY mode operation but if frequencies below 4 MHz are being used this will not be a problem. Several LF users have adopted this approach.

Loop Alignment

If you are unable to align the loops with the cardinal points, you can apply an offset during installation to compensate.

To show the setup panel, click Preferences > Antenna a second time. This extra step reduces the chance of inadvertent changes. Offset not adjustable in Client mode.

This is a set-once-per-installation choice reflecting the alignment of the north south loop with respect to actual north. Aziloop can compensate for other physical loop headings if the offset is a 15-degree multiple.

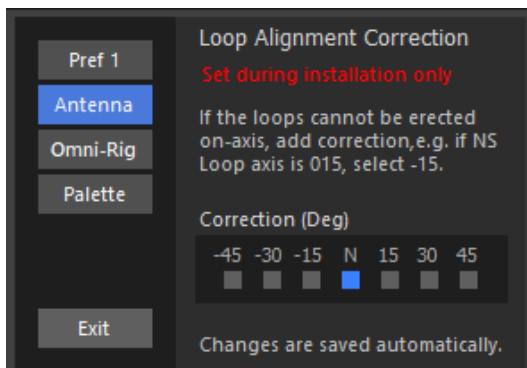

For instance, if the NS loop heading was 030, then select the -30 option to cancel it.

The supporting Pole

This should be non-metallic. Other than that, use whatever is to hand but insulate metal poles from the ground. Bearing in mind this is a small structure that is normally held upright by the loop wires forming part of the guying system, a pole of lightweight construction is sufficient though it's a good idea for the pole to be able to support itself should a wire break or come loose.

A low-cost fibre glass fishing rod pole or 'roach pole' or telescope flag / windsock pole will do nicely (buy a longer one and use the thicker sections) but avoid carbon fibre versions. Even a wooden pole would do. For the ground support you could hammer a short length of metal rod into the ground or choose from the many types of parasol mount available from Amazon and elsewhere.



Engineering Composites Ltd near Chester UK have a good range of high-quality fibre glass poles with telescoping sizes and a free cutting service. They are used to dealing with radio amateurs and have already supplied poles for Aziloop installations. They advertise in Radcom.

The antenna wires

Don't be too precious about loop dimensions, just make both loops the same size. Theoretically thicker wire is better for VLF work but in practice 24/0.2 (24 strands of 0.2 mm) PVC covered equipment wire is fine for general use. It's low cost, plenty strong enough, and on a practical point, the wires will fit snugly through the compression gland, even if you also use four radial wires.

Choose between ground or radials

The K9AY earth

Gary K9AY recommends an earth rod as a ground connection. We believe this method, and the limitation of a fixed value of load resistor may not give the best front-to-back ratio.

The Aziloop earth method: using radials

QuietRadio have modelled various earthing methods and suggest radials, ground mounted or elevated as a better alternative to an earth spike. At sites with a poor earth conductivity, radials will improve K9AY mode F/B performance especially at lower frequencies.

Using elevated radials

You will find the optimum load resistance will increase compared to using a ground earth. You can adjust the Aziloop load to a maximum of 950 Ω via the load panel of the main UI.



A stainless-steel earth bonding block may come in handy while experimenting with earth options but be aware of long-term weatherproofing issues. Spray with WD40 etc.

Route the wires directly into the LCU once you've settled on an earthing method.

Only install four radials and position them directly under the loops. Extend them several feet beyond the footprint of each loop if possible. This isn't critical but keep to the same length for each radial.

The earthing choice is yours, but see the plots below which may help you decide.

Earth type comparison (K9AY mode)

You may not have any choice over which you can use, but EZNEC plots show some differences to be aware of. (Model: Loop sides 2.4m, Frequency 3 MHz). Bear in mind these are models not real world cases.

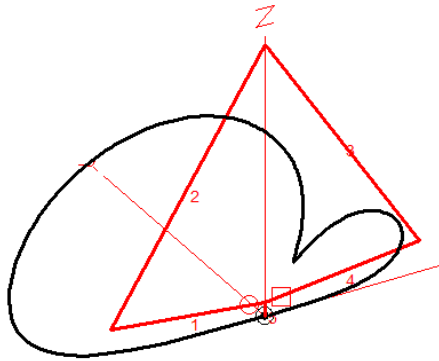

K9AY Real earth. Loop 25cm agl.

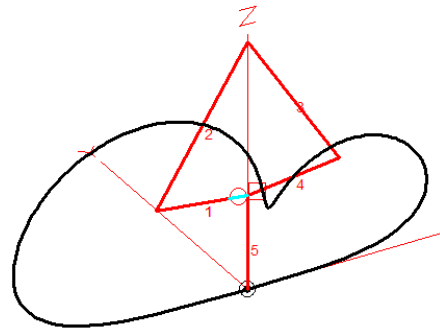

K9AY Real earth. Loop 2.5m agl.

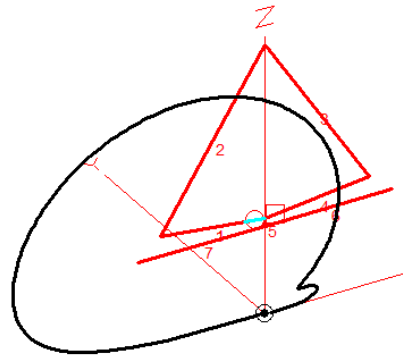
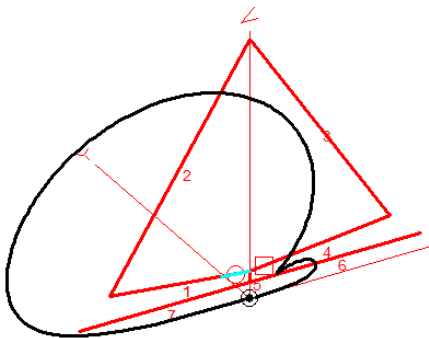

Is your feeder good enough?

At HF unless the cable run is extremely long (> 100 metres) then 5 mm OD RG58 is adequate. The issue is purely the voltage drop due to the DC resistance of the feeder. RF losses at HF will be minimal.

Try to keep the DC loop resistance of the feeder below 5 Ω . Official Belden RG58 specifications show a loop resistance of 14.8 Ω per 1000 feet (or 304.8 metres), equating to approximately 5 Ω on a 100 m run. Existing feeders formerly on passive systems can deteriorate without you knowing – **check loop resistance first.**

Poor quality or deteriorated coax has been the only installation issue reported, - fixed when the coax is brought within specification.

For longer runs simply use thicker coax. DO NOT be tempted to increase the 13.8 V supply to compensate.

Avoid!



Avoid low quality adapters in your coax run such as BNC to terminal block converters. These are often poor from the outset and can have high resistance internal connections.

If you install your feeder over ground in open countryside, it's only a matter of time before it gets chewed by something unless you can tie it to a fence or run it in ducting. Serious installations should consider using good quality direct burial cable such as 5 mm OD Messi & Paoloni AIRBORNE .5/200" (Loop resistance 15.6 Ω per 1000 `).

Using tougher direct burial cable over-ground may sound like a good choice to combat rodent aggression but check your cable is UV resistant otherwise over time it may become brittle and crack when exposed to sunlight.

Aziloop Elevated radials 25cm agl.

Aziloop Elevated radials 2.5m agl.

We suggest the Aziloop radials method is superior in most situations. Load resistances are greater with elevated radials and output level is slightly lower overall. We suggest you mount the loops close to the ground and experiment with earth types. But don't use both together. If you do, real earth is dominant.

Coax choices.

The system is designed to operate with 50 Ω coax and a 50 Ω receiver input impedance. However, if you happen to have a spare 75 Ω coax run pre-installed you can use it. If azimuth errors are observed insert the preamp to isolate the feeder.

The compression glands on the LCU are for cable diameters of 4mm – 8mm. They can be unscrewed to make a larger hole but take care to adequately weatherproof any 'custom' arrangements.

Attaching the loops to the pole



Attaching the loops to the pole need be no more complicated than the use of a few cable ties.

The loop wires themselves form part of the guying system.

Note the pole mounts can be unscrewed if mounting on a flat surface such as a wooden post. (fixing screws under the flaps in the lid)

Or do it like the professionals – here using stainless steel wire:



Photo courtesy Steve VK5SFA

Apex suggestions

Many arrangements are possible depending on the pole material used and what clamping force it will tolerate.



There is also a plethora of accessories on the likes of Amazon that seem tailor made for the job. Search for 'flagpole mounting rings'.



Tent pole cap

Or:



Note the two loops are kept electrically separate at the apex.

Photo courtesy Steve VK5SFA

Tensioning the loops

Pretend it's a tent.



Remove before mowing.
We use pitch marker spray
to find the holes again.



Side tensioning may
need no more than
this at a controlled
location.

Mower friendly.

This installation uses triangular loops with the bottom leg parallel to elevated radials.



Photo courtesy Steve VK5SFA

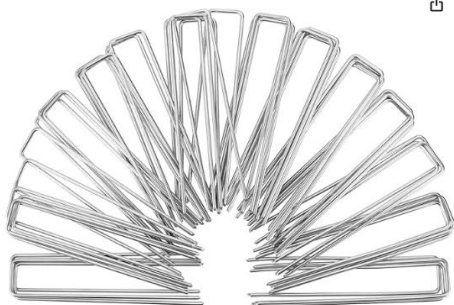

Galvanized steel 'garden pegs' are
available cheaply online and are a good
way to keep on-ground radial wires in
place until they 'grow-in'.

6.4 Installation - LCU

Step 1: Attaching the wires

All connections are made via terminal blocks inside the case.

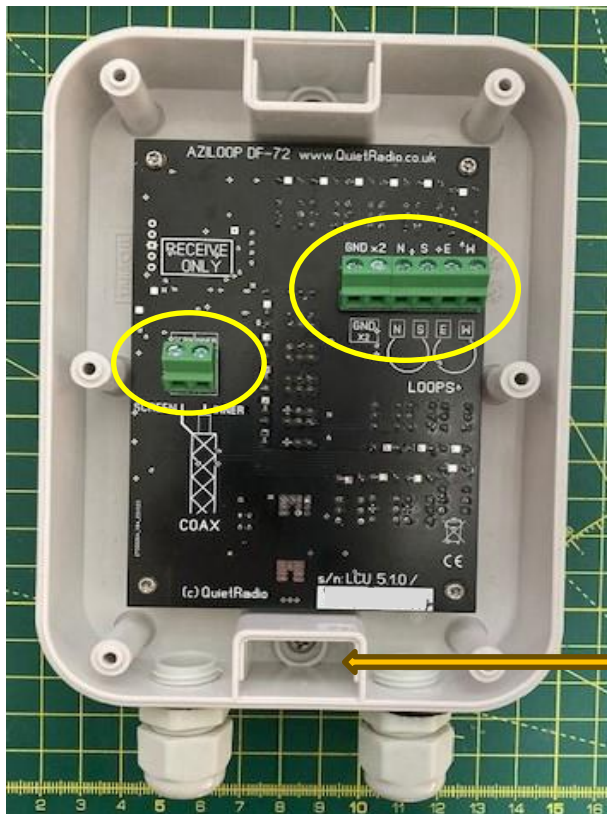

Two common earth terminals are provided. If you're using a radial system each terminal can easily accept two wires of the recommended size.

If you accidentally reverse the coax connections you won't blow anything up, the LCU just won't operate until you swap the wires.

Pole mounts can be removed if required, e.g. when fixing to a flat wooden post.

Attaching the Coax.



The coax should be stripped back to form two bare wires.

We find plumber's PTFE tape useful for binding the coax 'Egyptian mummy' style to prevent frays.

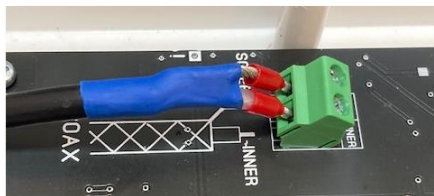

Ferrules and heat shrink even better.

Attaching the antenna cables

The cable compression glands on the LCU enclosure will clamp cables of overall diameter between 4 mm and 8 mm. We find eight 24/0.2 wires fit snugly (four for loops, four for radials).

At a stretch you can remove the black inner sleeve inside the gland and gain a millimetre or so extra, or even drill the dome out to 10mm if you're desperate. Broken glands can easily be unscrewed and replaced. The thread is PG9.

If you must use thicker cables, you will need an external junction box to reduce the thickness to something that fits the glands, but really there's little point from a performance perspective unless your coax run is several hundred metres.



Label the wires before you start, then make twisted pairs out of the two wires from each loop. Thread the wires through the compression gland and attach to the terminal blocks. Double check the wires go to the correct terminals.

There's less chance of the wires snagging if you strip the ends *after* passing through the compression gland.

Step 2: Attaching the lid.

Double check all the terminal block screws have been tightened. You don't need to overtighten the screws - we use rising cage terminals which firmly grip the wire without excessive force.

Recommendations

1. Check the sealing gasket is correctly seated.
2. If possible, screw down the lid before mounting on the pole – there's less chance of you dropping a screw into the grass (it'll be gone forever). They are M 2.5 16 mm stainless screws if you need to obtain replacements.
3. Apply and lightly tighten the screws one by one. That way there's less chance of one being forgotten.
4. Once all six screws are in place fully tighten using the diagonal 'cylinder head' method. Do not overtighten – use your common sense.

Feeder positioning

Sub-optimal feeder installation may lead to poor front to back ratios and azimuth errors. Arrange for the feeder to leave the LCU midway between the loops and bury it if possible. Keep the coax feeder away from the radials i.e., don't cable-tie a radial to the feeder! The ground plane is part of the antenna, and the feeder isn't (or shouldn't be).

Static build-up prevention

To avoid static build-up the LCU includes 100k bleed resistors from the earth terminal and each loop to the coax outer, which should not be left floating at the shack end, especially if elevated radials are used. If an earth rod is used there is a path to ground via that. These resistors have no effect on the RF performance of the loops.

Do not connect the coax outer directly to the Aziloop K9AY earth at the antenna – this *will* adversely affect performance.

Ferrite is good

This is not essential, but some users have reported a worthwhile improvement in nulls and lower noise floor when type 31 ferrite cores are placed over the coax say 20 feet away from the LCU. We also recommend placing cores over the feeder at the CIU end. Of course, if there never was any noise to filter in the first place you won't see any improvement. Every site is different so some trial and error may be needed.

A deep null can be compromised when feeder re-radiation or direct injection fills it back in again. Ferrite chokes create a high impedance point on the outer of the feeder which sounds a good idea but it's possible for wrongly placed ferrites to do more harm than good. A high impedance point creates a low impedance point somewhere else. The best thing to do is experiment.

It's easy to slide or re-position clip-on chokes along the coax but you'll need a few to make any difference – at least four and preferably more. If you find a 'sweet spot' you can always replace them with a ferrite ring later or use multiple turns on fewer cores, coax diameter permitting.

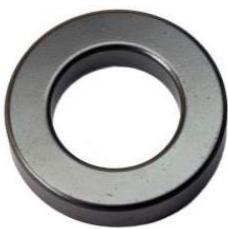

FT240-31 rings (above left) can produce a higher impedance for a given size because you can thread more turns through, but sliding one along the coax is challenging.

In the UK, Qubits at <https://radio-store.uk> offer a wide selection of ferrites. RS Components (formerly Radiospares) also have a broad selection on offer. Digikey also offer type 31 ferrites at an attractive price especially if you buy in quantity to get free shipping – consider a club buy.

Step 3: Attaching the LCU to the pole



Finally, use two cable ties to attach the LCU to the pole, top one first, mounting the LCU with the cable glands downwards. Take care to insert the ties through *both* slots in each pole adapter. It's easy to miss one if you're not paying attention. For a more professional job use stainless steel jubilee clips instead. Remember the adapters are plastic – don't needlessly over-tighten the ties or clips. For testing you can hold the LCU in place with a tie on just the upper pole mount and let the LCU hang off the pole.

You can remove the pole mounts if you are attaching to a flat surface such as a 4 x 4 wooden post.

It doesn't matter if you place the LCU inside the loop, though it's better to keep any vertical part of the K9AY earth connection as short as possible.

LCU enclosure orientation

Install with the thin sides facing the midday sun. The case is weatherproof and UV resistant so needs no further protection. DO NOT paint the box – the light colour helps keep it cool.

Camo vinyl wrap (lighter coloured variety) is a possibility for making the enclosure less visible though we've not tried it.



The preamp circuitry and relays generate heat. Heat energy only escapes if the enclosure is cooler than the air inside, so if the case is heated by the sun the internal temperature will inevitably be that much greater. If you happen to be in the middle of a desert, then it makes sense to also provide some additional shielding from direct sunlight. Correctly installed, Aziloop has survived a 40°C Australian Summer and worked perfectly throughout.

APPENDIX 1 Aziloop in Practice

Your signals may vary

The ionosphere is constantly changing, and arrival angles from the same station can change from season to season, day to day or even minute to minute, along with even more rapid changes in polarisation.

You will experience different effects on the same station, at times almost suggesting your antenna isn't working. The chances are the antenna is fine, it's the ionosphere that's 'not working', as in not behaving how you were expecting. Vertically polarised LF stations will only be audible via ground wave in daylight, while after dark the sky wave element kicks in. Low angle vertical signals can change to medium/high angle mixed polarisation stochastic signals. This explains why a few hours previously you could null a station out, but now, after dark, it's no longer possible. It is, as they say, how it is. See [Appendix 2](#) below.

As a confidence check that your system is working, we suggest you find one or two reference stations on different headings, maybe a local NDB or MW broadcast station that will always be received by ground wave and take some readings for comparison.

Which antenna mode is best, K9AY or Loop? Which direction is best? If you were previously using a fixed-heading single loop, though you never realised it, a lot of the time your antenna was under-delivering. With Aziloop you have 108 choices, not just one (72 K9AY headings, 36 loop headings).

External noise limiting

Achieving the best receive performance is essentially all about achieving the best signal to noise ratio. It is most definitely not about achieving the highest S-meter reading per se. Once your station has achieved **external noise limiting** – by which we mean distant 'band noise' clearly swamps equipment noise or local interference - there is little more to be achieved other than modifying an antenna's gain or reception pattern.

The starting point is the receive equipment noise figure (how much your equipment degrades reception by adding circuit noise). It's impossible to eradicate completely. Even passive components such as resistors add circuit noise. If you study the more professional receiver comparison tests you may be surprised to learn just how poor the noise figure of some equipment really is. Most of the time it doesn't matter because noise picked up by the antenna will completely mask this. There comes a point though, where reducing the signal input level will start to degrade the signal. Apply a 10 dB attenuator and you may not notice a difference but add another 10 dB and you will. Some SDR apps (such as Airspy SDR#), have a signal to noise meter instead of or as well as an S-meter in recognition of this.

Appreciation of this is a key factor in achieving the best results from lower output receive antennas i.e. small receive loops. With Aziloop you have around 36 dB of level control available by way of an 18 dB preamplifier and a 0-6-12-18 dB attenuator, allowing you to optimise signal levels. If you can't hear band noise with the preamplifier inline and 0dB selected, you are one of the privileged few who have a very quiet site. Try increasing the size of the loops to produce more signal, but bear in mind as you increase the loop size you decrease the frequency at which the K9AY lobes begin to deteriorate.

Once you have achieved external noise limiting, continuing to increase signal levels is just making an overload situation more likely. Most SDR receivers have an input overload warning which can be triggered by frequencies many MHz away from where you are listening. Many (but not all) SDR receivers have input filters that help, and so does Aziloop. See the section on the [Band panel](#).

Compatible receivers

With the range of level control provided by Aziloop, just about any receiver should be compatible, be it SDR or classic (analogue). If you feel your receiver is 'deaf' on LW/MW compared to higher frequencies, check for a 'hidden' attenuator setting that kicks in automatically. You can usually override this – for instance in the Icom 7300 transceiver (but see the cautions below about using a transceiver).

In the lab we've tested Aziloop with the Colibri Nano, Airspy HF+, SDRplay RSP1, RSP2, RSPdx, and our firm favourite the Perseus from Microtelecom. Also IC-7300, IC-705 and Anan 100D transceivers. The Airspy HF+ in particular is very sensitive, which can be an advantage if used with care. The downside of increased sensitivity is often an increased tendency to overload (if the levels aren't correctly controlled).

Bias-Tee: Some SDR receivers have a selectable bias-Tee voltage on the antenna input (e.g. some SDRplay models). This should be switched off to remove a possible noise source. If it's on by accident no damage should occur as Aziloop's Receiver port is DC isolated.

Transceivers – a warning

Many high-end transceivers have a dedicated receive-only input. Use this connector if you have one available (see [Silent PTT](#)). If you cannot contain yourself and you connect Aziloop directly to a transceiver's main antenna connector, be extremely careful. Remove the mic, turn the mic gain and RF to level to zero, avoid AM or FM, and make sure the rig isn't on VOX. Be aware also that some transceivers can emit a high-power spike on transmit even on low power.

One of our customers decided to test a transceiver with Aziloop and took most of the precautions but forgot about VOX. Luckily the burst of RF was very short lived and the protection diodes in Aziloop did their job. But you may not be so lucky!

Near field and far field

Most stations you want to listen to will be in the far field but local noise sources as well as all nearby objects, street wiring, house wiring etc. will be in the near field. The near field is generally defined as distances less than two wavelengths, with a transition zone from one wavelength. Only the far field represents properly formed electromagnetic radiation. The near field is much more complicated.

Near field signals decay at a faster rate than far field signals. Antennas don't work as you expect in the near field and a rotatable antenna will react to local noise in a different way to how it reacts to distant stations. Nonetheless, being able to rotate your antenna allows you to find the best signal to noise ratio. Remember, it's all about maximising signal to noise ratio, not signal strength per se.

Normal Aziloop behaviour

The following characteristics will go unnoticed for many, but we mention them here to clarify what constitutes 'normal' operation.

Amplitude ripple

You may notice a variation of a few dB as you change heading, particularly in K9AY mode. How much depends on the contribution from near field noise, and the arrival angle and polarisation of wanted signals, and it would be nigh impossible to compensate for factors outside Aziloop's control. The slight changes do not affect performance if you maintain external noise limiting.

Data noise and switching noise

Aziloop uses baseband signalling to convey control data to the LCU. There is a 20 kHz 5-pole high pass filter permanently in circuit in the CIU to remove this from the signal path. You may still hear traces of control data if you tune below 50 kHz.

At low frequencies relay switching noise may be apparent, caused by the inevitable momentary break in signal, and sometimes contact bounce. This is usually only apparent at frequencies below 200kHz.

Band filters

The 7-pole relay-switched band filters are very effective in reducing unwanted signals close-by due to the sharp cut off seven poles provides. However, capacitive coupling across the relay contacts ultimately limits performance at higher frequencies, e.g. with the 500 kHz filter enabled, signals on 28 MHz, though greatly reduced, may still be noticeable.

A1.1 Troubleshooting

Problems can be broken down into two types: Initial problems – there from the start, and in-service problems – where something has changed.

Initial problems

We suggest that before installing the LCU you connect it to the CIU / PC on the bench. You should hear relay noise for every adjustment you make (antenna, load, band, preamp, attenuator). The attenuator relays are in the CIU, everything else is in the LCU.

Antenna not responding at all, or intermittently.

The only reported issue has been faulty coax that has gone high-resistance, often unnoticed if previously used in a passive receive situation. We recommend a coax loop resistance of under 5 Ohms.

Antenna responding consistently but wrongly.

Chances are the loop wires have been incorrectly attached to the LCU terminal block. Mark each wire with stripes using a marker pen (I, II, III, IIII) before attaching.

Problems in-service

Re-check the coax loop resistance if applicable and do the relay audio checks as above.

Check for loop wire damage. A common problem is local wildlife walking into the wires, and creatures with sharp teeth taking a liking to coax.

If you notice a drop in signal level but otherwise operating ok, check the preamp by switching in and out. There should be around 18 dB of gain.

A good plan is to make a note of what constitutes normal operation – initially log the heading and signal level of a nearby broadcast station or NDB etc. then you have a reference.

If you have the slightest concern something may be amiss, please don't hesitate to contact us.

A1.2 RF Noise issues

Unwanted noise can be present in any system and the information here applies not only to Aziloop, but to any setup where you are mixing multiple power sources and multiple earths. Noise problems can be there from the start or appear later. Noises that appear later are most likely to be external to your system, picked up by the antenna when some new electronic device gets plugged in.

Equipment noise

The USB connection to the CIU is opto-isolated, and the Ethernet RJ45 is galvanically isolated within the socket (but if you are using this, make sure you use unscreened Ethernet cable to avoid coupling the CIU 0 V to whatever is on the other end of the RJ45.) These connectors therefore shouldn't cause any problems.

If there's noise, there's current flow. And current only flows in a circuit. So, think about your setup and imagine if you were an electron, are there multiple paths you could take? Is there a chance that noisy power supply current is taking the same path as RF current?

Here's one possible scenario: Single power supply for CIU and receiver. Both the CIU and the receiver have two 0 V paths, and one is via the outer of the coax from the CIU to the Rx.

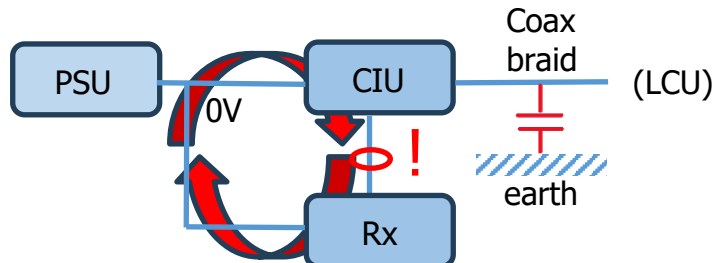

Also, the screen of the coax to the LCU is connected to the CIU 0V. This will capacitively couple to the real (soil) earth and potentially create another path if there is noise leakage to ground from the PSU. Our CIU USB port is optically isolated, but the chances are that a USB connector from the PC to a receiver won't be – definitely the case if the receiver is USB powered as many are. So, there's also a chance of coupling **PC noise** into the system.

This sort of issue usually only becomes apparent at low frequencies, where noise energy is greatest, and you may not have any problem at all. But if action is needed, ferrite is your friend. A nicely stocked bag of type 31 clip-on ferrites can work wonders.

Also, you could try replacing the supply feeding the CIU, the receiver, or both with a battery, and see what happens.

If you use a USB powered SDR dongle, try substituting with a conventionally powered receiver, or something like an IC-705 on battery as a test. If you have the part to hand, try fitting an RF isolation transformer in the CIU to Receiver coax. Test at all frequencies to make sure that a fix in one band doesn't create a problem in another.

Using Aziloop to locate external RF noise

Discover noise contributors by noting any changes in noise level at each step.

1. Start with the 13.8 V to the CIU disconnected.
2. Plug the 13.8 V in but leave the LCU un-powered.
3. Power up the LCU with the attenuator on infinity.
4. Now set the attenuator to 0 dB in 6 dB steps.

If the noise tracks the attenuator setting then it could be coming down the coax, or picked up by the coax, or being injected into the 13.8 V supply and appearing on the DC to the LCU, back-feeding into the receiver.

Turning to the LCU:

5. Does the noise rise and fall with the preamp in and out?
6. Apply a band filter as far out of band as possible – does the noise drop or go away?

If the answer to either 5 or 6 is yes, then the chances are you are dealing with external noise picked up by the antenna itself. Change between K9AY and Loop modes, and rotate the antenna, looking for a null or definite peak somewhere. You may find it's far worse in K9AY mode and virtually absent in Loop mode, strongly suggesting a nearby external source. You may be left with the obvious choices – find and fix the external noise or move the antenna further away.

Some external noises are easy to identify, electric fences being one, with regular one second ticks. Often several can be heard with slightly different time intervals. By rotating the antenna to find a null, then using K9AY mode to resolve the direction along the null axis, one user was able to find a likely direction. Google Earth identified a farm and indeed they had several (badly) installed units. Switch mode PSUs have evenly spaced (circa 15- 30 kHz) harmonics all across the band. MPPT solar charging regulators can sound similar but the spikes 'hunt' in frequency.

RFI own goals



Don't be quick to blame 'the neighbours' every time a new noise appears on the bands. We were puzzled by a regular pulsing noise across the spectrum that sometimes went away or changed signature. It turned out to be a new cordless mobile phone charging stand in our own lab!

A1.3 Aziloop applications

The following use cases can apply to any standard loop or any K9AY loop, not just Aziloop. However, with Aziloop, the ability to swap modes and headings in literally milliseconds makes light work of tasks that are essentially out of reach for static, single mode antennas.

Direction Finding

The DF-72 resolution of 5 degrees gives a theoretical worst case directional error of 2.5 degrees which is more than sufficient for many basic DF applications. Use loop mode to determine the null axis, then use K9AY mode to resolve the direction ambiguity.

Avoiding the neighbour's new toy

Local noise from SMPSUs, ADSLs and the like can be greatly reduced or even eliminated using Aziloop's 5-degree steps. As noise sources change, re-align to counter each one as needed.

Atmospheric noise reduction

On LF and HF particularly in summer months, thunderstorm static can be troublesome to the point of making some frequencies unusable. Using Aziloop's front to back performance in K9AY mode, or the side nulls in Loop mode, such problems can be reduced or even eliminated.

Resolving co-channel stations

Sometimes the reception of one station on a channel is overpowered by a second co-channel station. These can often be separated and 'picked off' at will by simply changing Aziloop settings. Experiment with both K9AY and Loop modes, making full use of the variable K9AY load to move the rear notch towards the angle of arrival of the unwanted station (note this is not always possible as adjustment is limited).

NDB Listening and MW dxing.

LF work such as NDB listening is given a new lease of life because of Aziloop's ability to quickly remove or reduce interference from nearby stations.

Low angle DX listening

Aziloop in K9AY mode can compete with bigger antennas and give surprising results on DX stations, improving signal to noise ratio by reducing unwanted signals and noise to the rear, and giving a better low angle response compared to Loop mode.

APPENDIX 2. Understanding your Aziloop

Note: The plots and comments below apply to any K9AY and any small loop antenna, not just Aziloop.

We will show two types of antenna plot, the azimuth plot and the elevation plot. An azimuth plot is a measure of radiation pattern in the azimuth plane, as if you were hovering above the antenna looking down. A plot in the elevation plane is a measure of the radiation pattern at various elevation angles with respect to horizontal, as if you were standing some distance away looking across at the antenna.

One other thing – polarisation. Knowing how an antenna responds to different polarisations, and which are relevant is key to understanding what to expect. For instance, when receiving vertically polarised ground wave signals, an antenna's response to horizontal polarisation is immaterial – there is nothing to receive. However, if the signal's polarisation is random (like after ionospheric refraction), then the total field - which is a combination of horizontal and vertical polarisations, needs to be considered.

A2.1 Loop Mode

Think of small receive loops (circumference less than 0.1λ) and a 'figure of eight' reception pattern may spring to mind. Then again, the same loop is often described as 'omni-directional'. They can't both be correct, can they? Well, it depends...

Azimuth plots

Here below are two different azimuth plots from the same small loop antenna. The plane of the loop is along the X axis.

Az_1. Elevation 90 degrees

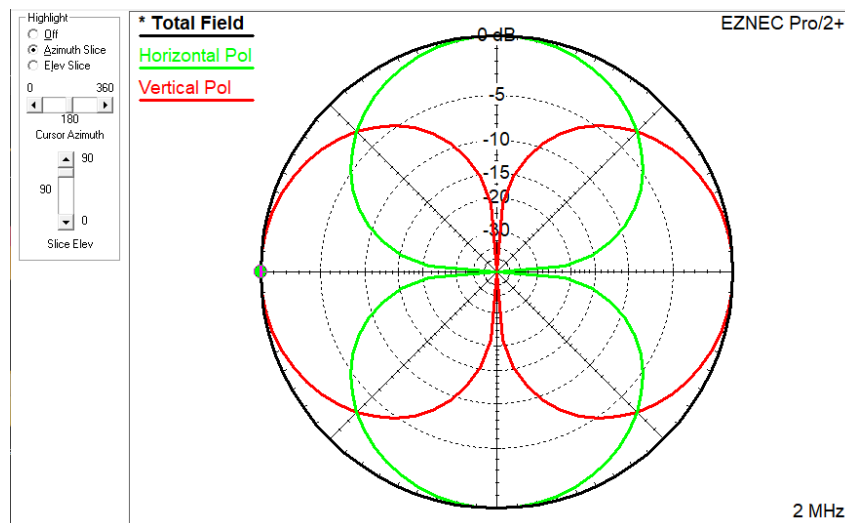

Notice total field is circular, made up of horizontal and vertical responses combined.

Az_2. Elevation 5 degrees

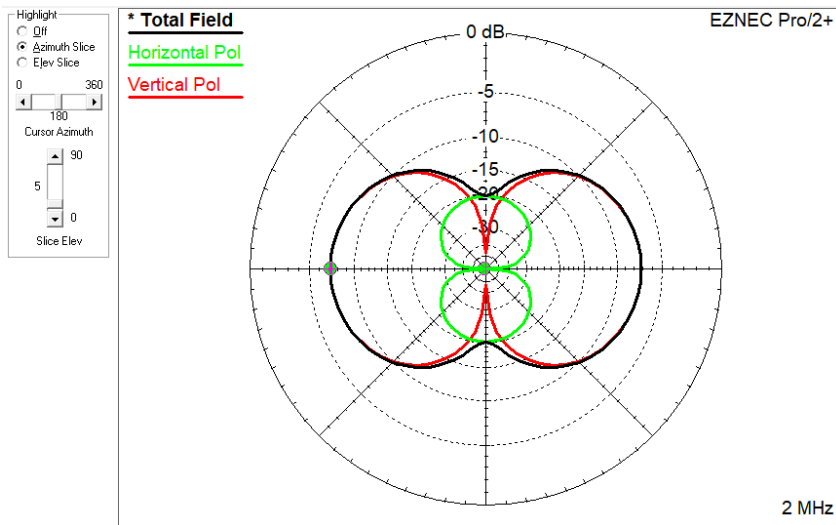

The amplitude of all signals has decreased, but more so for horizontal signals.

The figure of eight pattern is starting to emerge for the total field.

EI_1. Elevation slice – On-axis

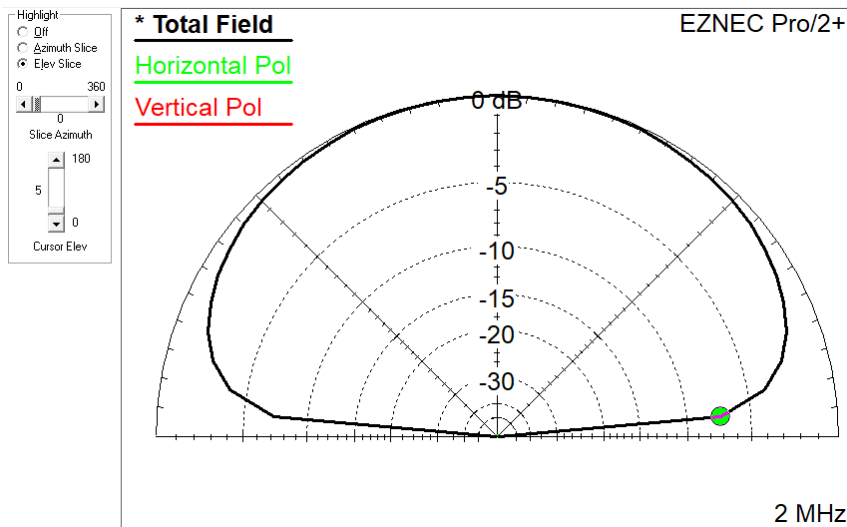

Not shown, but the total field is just vertical polarisation. Consistent with Az_1 and Az_2 above.

There is no contribution from horizontal signals.

El_2. Elevation slice – 45 degrees off-axis

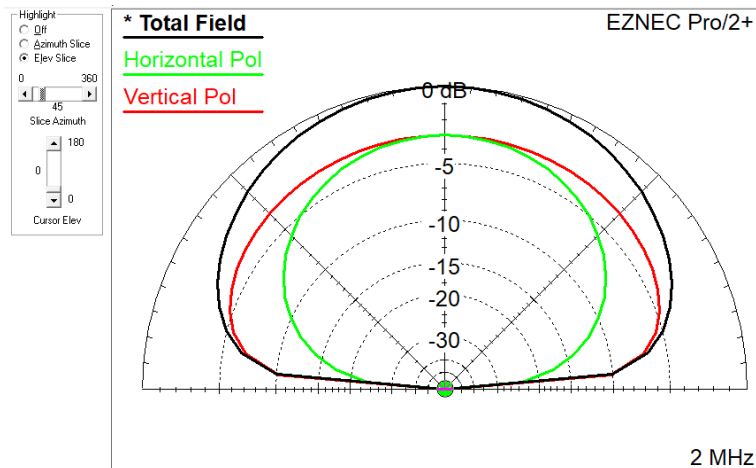

At 45 degrees the Vertical signal is dropping, and the Horizontal signal is increasing.

El_3. Elevation slice – 90 degrees off-axis

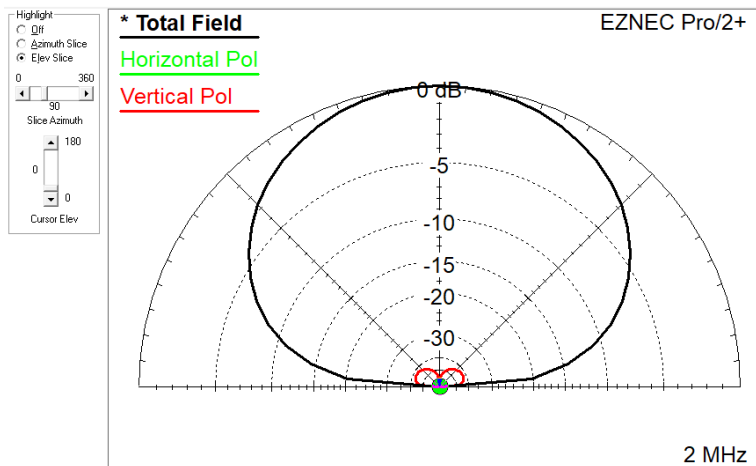

At 90 degrees off-axis that total field is now almost entirely horizontal.

Consistent with the trend shown in Az_2 and El_2 above.

Conclusions

- High angle signals appear stronger than low angle signals.
- High angle signals are sky wave, with stochastic (seemingly random) polarisation. You often cannot null such signals (or DF using the null method).
- More distant sky wave signals have correspondingly lower arrival angles, and it is possible to observe slight side nulls.
- Ground wave signals are vertically polarised. You can always null / DF such signals.
- Stations that are heard via ground wave in daylight but also via sky wave at night can become distorted when the two signals combine.
- Stations with a null during daytime may have no overall null after dark.

A2.2 K9AY Mode

Renowned as a good DX antenna, the K9AY is another variant in the family of terminated loops, along with the Pennant, EWE and Flag antennas, all of which operate on the same basic principle. The DX capability comes from the low angle, cardioid shaped main lobe that responds to vertically polarised signals. Many descriptions of the K9AY antenna are available online including from Gary Breed, K9AY himself.

For the K9AY to work properly, phase changes across the antenna should be negligible. Thus, for a given antenna size there is a maximum frequency above which the lobes begin to gradually deteriorate. At higher frequencies the antenna behaves more like a vertical element, assuming an omnidirectional pattern. Despite the loss of directivity, the low angle reception is still an advantage for DX work.

The cardioid pattern is still maintained to very low frequencies, but the received signals fall off in strength as the antenna gets smaller. Thus, there is a balance to be achieved between maximum frequency and minimum acceptable signal level.

K9AY elevation plot on-axis

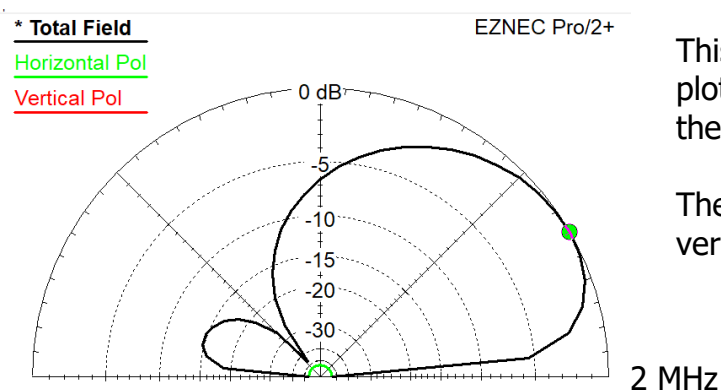

This is the classic on-axis elevation plot usually shown when describing the K9AY.

The total field is almost entirely vertical polarisation.

Off-axis K9AY

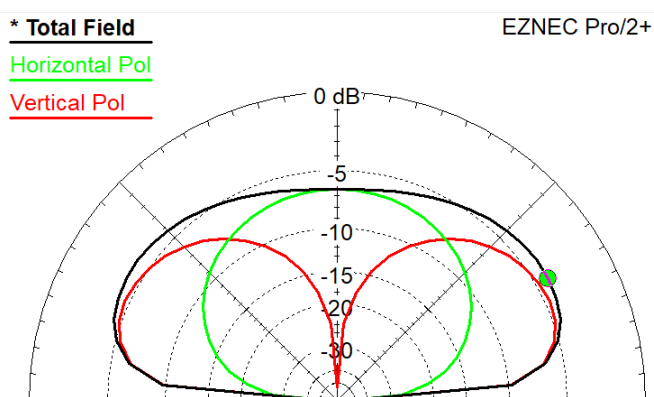

This is the same antenna, plotted at 90 degrees off-axis. There is now a significant response to both horizontal and vertical polarisation.

Note that at 90 degrees elevation the total field amplitude is identical to the on-axis plot.

One could argue that the best heading for minimum fading is something to one side of the actual heading, to receive both polarisations. Same goes for Loop mode. All a question of suck it and see.

K9AY elevation plot on-axis at higher frequencies

The elevation plots above were modelled at 2 MHz. Now let's run a plot again at 14 MHz and 28 MHz.

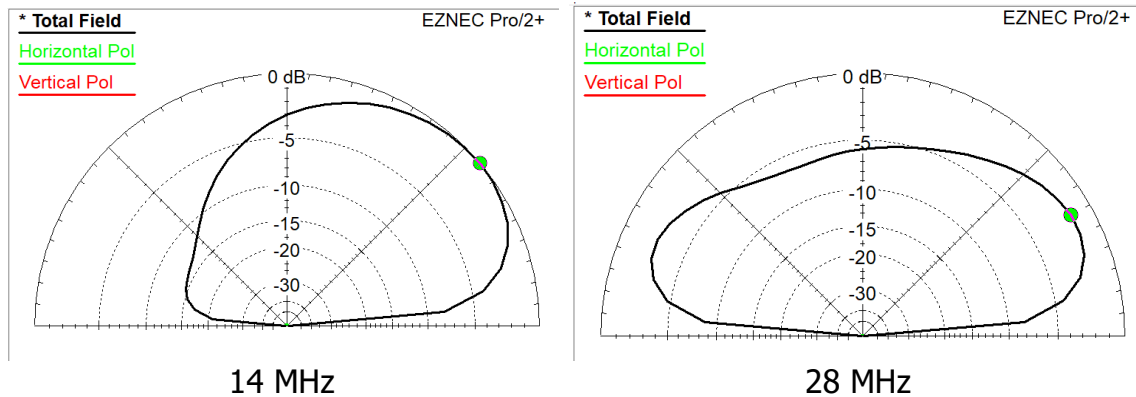

The pattern is clearly deteriorating, with a much poorer front-to-back ratio that will further deteriorate as the frequency is raised. As previously mentioned, at higher frequencies, even though directivity is lost, the antenna is still a useful for low angle DX reception.

K9AY elevation off-axis at higher frequencies

Now the same 14 MHz and 28 MHz plots, this time 90-degrees off-axis.

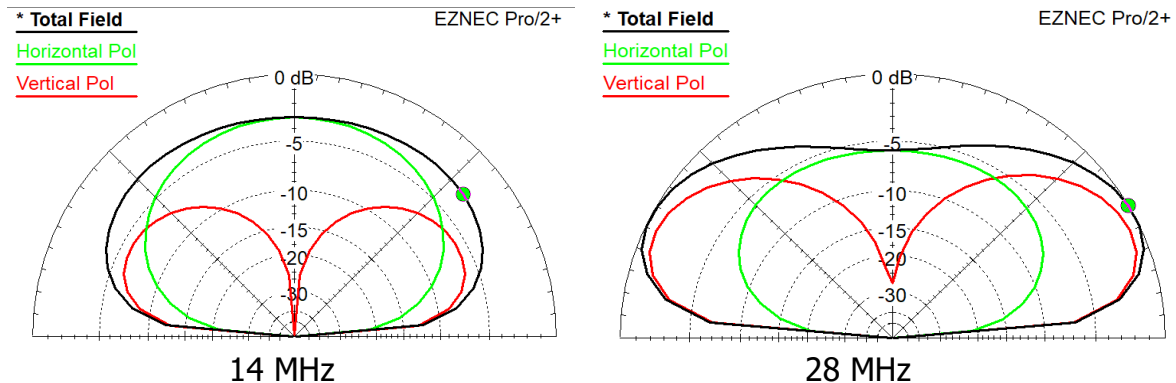

The elevation pattern doesn't change by much compared to on-axis pattern. This illustrates the tendency for the K9AY to behave like an omnidirectional vertical at frequencies above its 'in-spec' limit. Already mentioned is the importance of balancing antenna size against achieving external noise limiting. Smaller K9AYs have a higher in-spec frequency limit.

Azimuth plots

Finally, a look at some 2 MHz azimuth plots for the same antenna at various elevation angles

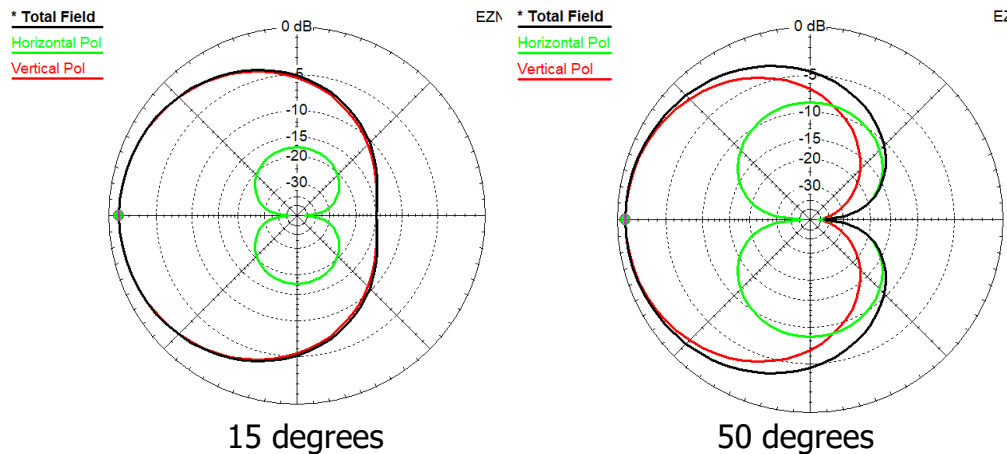

You can see the change in the vertical lobe at 50 degrees elevation as the notch between the front and rear lobe takes effect.

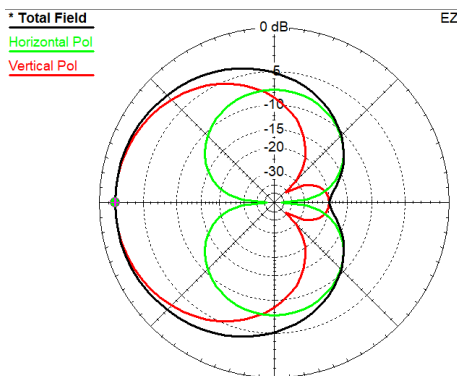

Now let's go up just another 10-degrees for a 60-degree azimuth plot:

Look at the red vertical polarisation response. At these higher angles the rear lobe is developing a double null. This is observed in practice, so DF using a K9AY rear null cannot be relied on.

Conclusions

- The loop antenna and the K9AY antenna have different but complimentary performance characteristics. Having a choice of both at your fingertips, in any direction, is a huge advantage over a fixed heading single loop. Over time you will get a feel for what works best in different scenarios.
- The performance of the K9AY is more dependent on antenna size, and for best results this factor cannot be ignored when planning your installation.
- Neither antenna will display any significant directional characteristics at higher angles.

The K9AY 'party trick'

It can be an entertaining game to tune to a station and try for the best rear null. Under the right conditions nulls approaching 40 dB are sometimes achievable, 30 dB is often possible, and 20 dB is commonplace. Sharper nulls are always transitional and won't hold for long as ionospheric conditions are constantly changing. This 'game' relies on signals arriving exactly in that rear notch between the lobes. Bear in mind that trying this with very strong local stations is likely to be disappointing as every wire in your station will be picking up significant RF.

Changing the load value shifts the null angle slightly so if stations are the right distance away for the arrival angle to be about right you can tweak the load for optimum. For arrival angles way off the 'magic null' you'll not experience this effect and the front-to-back ratio though still useful will be much less. Although not apparent from the theoretical plots, in practice the nulls for ground wave signals can be equally as impressive.

As a rule of thumb, increasing the load resistance increases the angle of the null with respect to the ground. (in the limit where R is infinity you would have effectively destroyed the antenna's H-field by breaking the loop, and turned it into an E-field only antenna, where it would perform like a small vertical with an omnidirectional pattern at low angles.)

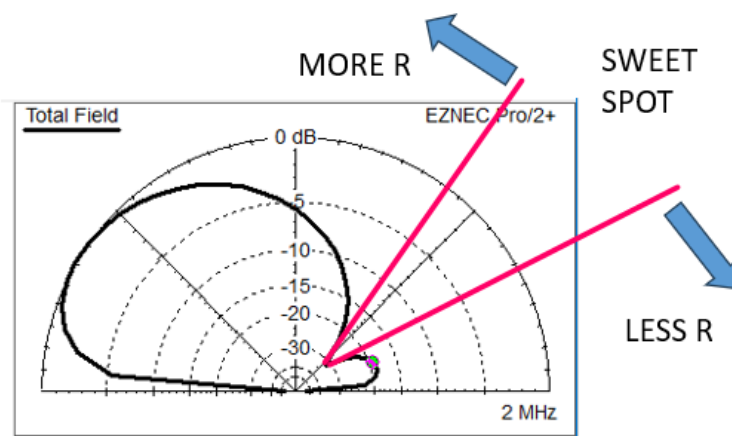

If you find a favourite station that you can drop into the null, you will find over the course of a day (and indeed over the seasons) the angle will alter (as witnessed by the need to change the load resistor value to hold the null) until no more adjustment is possible.

Will the load resistor require increasing or decreasing as evening approaches? We'll leave you to find that one out, along with lots of other propagation discoveries Aziloop makes possible...

_____ oOo _____



Reception. Reinvented.™

www.QuietRadio.co.uk