

# **SteppIR** <sup>TM</sup> **Antenna Systems**

Yagi    Dipole    Vertical    (Patent # 6,677,914)

## **3 Element Yagi Instruction Manual**



Antarctica at 75 mph

### **SteppIR Antennas**

2112 - 116th Ave NE, Suite 2-5, Bellevue, WA 98004

Tel: 425-453-1910    Fax: 425-462-4415

Tech Support: 425-891-6134

[www.steppir.com](http://www.steppir.com)

Rev: O 12/17/07

## SteppIR - Why Compromise?

The SteppIR antenna was originally conceived to solve the problem of covering the six ham bands (20m, 17m, 15m, 12m, 10m and 6m) on one tower without the performance sacrifices caused by interaction between all of the required antennas.

Yagi's are available that cover 20 meters through 10 meters by using interlaced elements, traps or log periodic techniques, but do so at the expense of significant performance reduction in gain and front to back ratios. Now, with the addition of the WARC bands on 17m and 12m, the use of interlaced elements and traps has clearly been an exercise in diminishing returns.

Obviously, an antenna that is precisely adjustable in length while in the air would solve the frequency problem, and in addition, would have vastly improved performance over existing fixed length yagis. The ability to tune the antenna to a specific frequency, without regard for bandwidth, results in excellent gain and front to back at every frequency.

The SteppIR design was made possible by the convergence of determination and high tech materials. The availability of new lightweight glass fiber composites, Teflon blended thermoplastics, high conductivity copper-beryllium and extremely reliable stepper motors has allowed the SteppIR to be a commercially feasible product.

The current and future SteppIR products should produce the most potent single tower antenna systems ever seen in Amateur Radio! We thank you for using our SteppIR antenna for your ham radio endeavors.

Warm Regards,

*Mike Mertel*

*Michael (Mike) Mertel - K7IR  
President*



# Table of Contents

<i>Topic</i>	<i>Page</i>
<b>Parts Abbreviations</b>	<b>4</b>
<b>SteppIR Design</b>	<b>5</b>
<b>Packing List</b>	<b>6</b>
<b>List of Figures</b>	<b>7</b>
<b>Assembling the Boom</b>	<b>8</b>
<b>Element Spacing and Position Drawing</b>	<b>9</b>
<b>Connecting the Boom to the Mounting Plate</b>	<b>10</b>
<b>Attaching the Element Housing Unit (EHU) to the Element Bracket</b>	<b>11</b>
<b>Control Cable Wiring Instructions</b>	<b>12</b>
<b>Control Cable Connection Drawing</b>	<b>13</b>
<b>Attaching the Wiring Enclosure to the Boom or Mast</b>	<b>14</b>
<b>Preparing and Attaching Telescoping Fiberglass Poles</b>	<b>15-18</b>
<b>6 Meter Passive Element Installation (Optional)</b>	<b>19</b>
<b>SteppIR Options</b>	<b>20-21</b>
<b>SteppIR Warranty</b>	<b>22</b>

## Abbreviations

EST	Element Support Tube
EHU	Element Housing Unit
FTP	Fiberglass Telescoping Poles
QDB	Quick Disconnect Boots

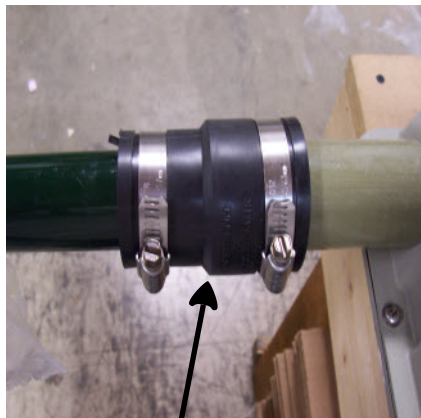
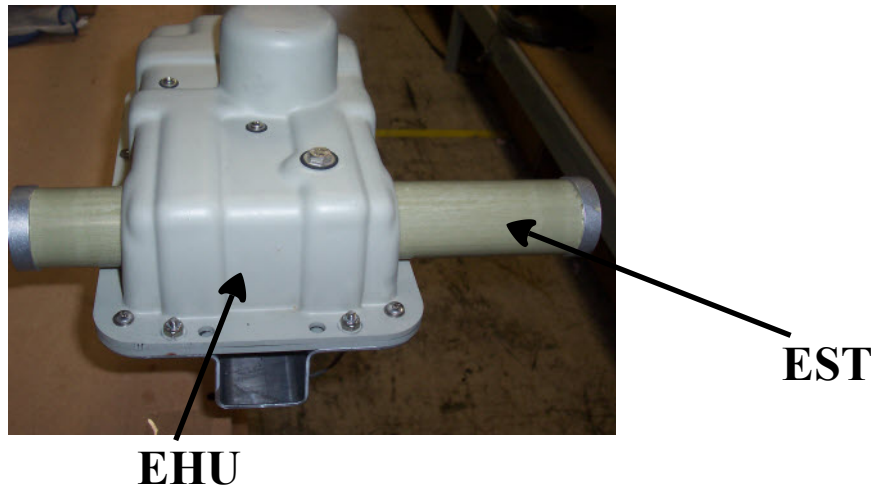

SteppIR Antenna Information Web Sites (as of 4/09/07)

<http://steppir.com/>

<http://groups.yahoo.com/group/steppir/>

## SteppIR Design

Currently, most multi-band antennas use traps, log cells or interlaced elements as a means to cover several frequency bands. Yagi antennas must be made a specific length to operate optimally on a given frequency. All of these methods have one thing in common—they significantly compromise performance. The SteppIR™ antenna system is our answer to the problem.

So, instead of trying to “trick” the antenna into thinking it is a different length, or simply adding more elements that may destructively interact, why not just change the antenna length? Optimal performance is then possible on all frequencies with a lightweight, compact antenna. Also, since the SteppIR can control the element lengths, a long boom is not needed to achieve near optimum gain and front to back ratios on 20 - 10 meters.

Each antenna element consists of two spools of flat copper-beryllium tape conductor (.54” wide x .008” thick) mounted in the EHU. The copper-beryllium tape is perforated to allow a stepper motor to drive the tape simultaneously with sprockets. Stepper motors are well known for their ability to index very accurately, thus giving precise control of each element length. In addition, the motors are brushless and provide extremely long service life.

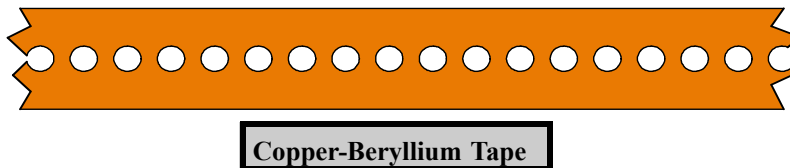

The copper-beryllium tape is driven out into the hollow fiberglass telescoping poles (see below), forming an element of any desired length up to the limit of each specific antenna model (a vertical uses only one pole). The fiberglass telescoping poles are lightweight and very durable. When fully collapsed, each one measures approximately 58” in length. Depending on the model, there may be additional extensions added to increase the overall element length.

The ability to completely retract the copper-beryllium antenna elements, coupled with the collapsible fiberglass poles, makes the entire system easy to disassemble and transport.

The antenna is connected to a micro-processor-based controller (via 22 gauge conductor cable) that offers numerous functions, including dedicated buttons for each ham band, and continuous frequency selection from 80m to 6m (depending on the model). There are also 17 ham and 6 non-ham band memories. You can select a 180° direction reversal\* or a bi-directional\* mode, and it will adjust in about 3 seconds (\*Yagi only).

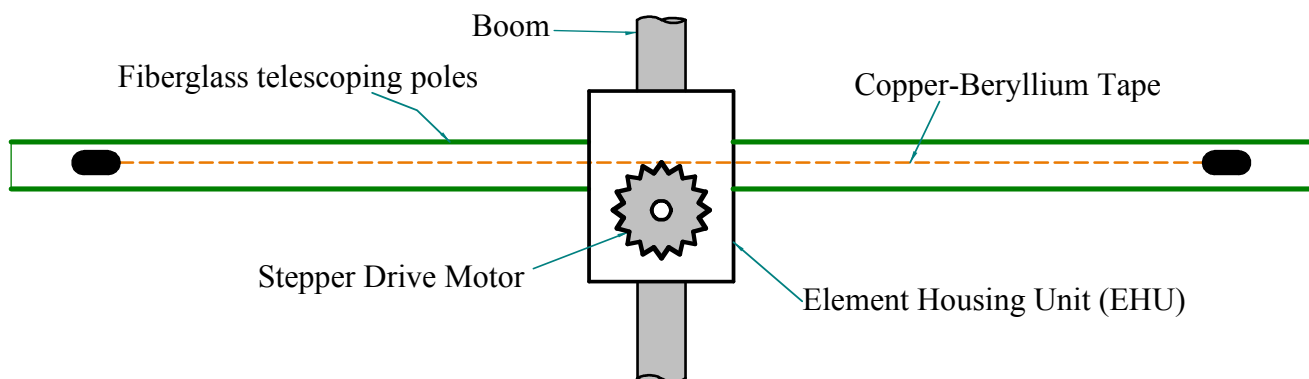



## PACKING LIST

ITEM	QTY	PART #	DESCRIPTION
BOX 1	1		Instruction Manual
	1		Operators Manual
	1		Controller
	1		Power Supply
	1		Driven Element Housing (EHU)
	2		Passive Element Housing (EHU)
	1		Mast Plate
	1		Boom (4 sections)
	6	10-1013-01	Fiberglass Telescoping Pole (18 Foot - 4 Segment )
	6	60-1006-01	Quick Disconnect Boot (1.5" to 1.25") (Fernco)
	1		Control Cable (12 conductor)
<b>Connector Kit</b>			
	1	10-1102-21	1-1/2" x 7" PVC Tube (Terminal Enclosure)
	1	60-1009-01	ABS Plug (End Cap for Terminal Enclosure)
	1	60-6000-35	3" Hose Clamp
	1	20-6020-12	12 Position Terminal Strip
	1	20-6020-01	1 Position Terminal Strip
	1	10-1029-01	Connector Protector (Blue Packet)
<b>Hardware</b>			
BAG 1	2	09-0001	Electrical Tape (3/4" x 66' Roll) Merco
	1	09-0003	Silicone Tape (20' Roll)
	1	09-0004	Silicone Tape (10' Roll)
	2	60-0003	1-3/4" U-Bolt & Saddle
	2	60-0004-02	2" U-Bolt & Saddle (4" Long Reach)
	3	60-0062	1/4-20 x 2-3/4" SS Bolt
	3	60-0030	1/4-20 SS Nylok Nut
	8	60-0046	5/16-18 SS Nylok Nut
	15	60-0041	1/4" SS Flat Washer
	26	60-0061	#10-32 x 7/8 SS Panhead Screw
	12	60-0017	#10-32 x 3/4 SS Panhead Screw
	26	60-0018	#10 SS Washer
	38	60-0019	10-32 SS Nylok Nuts
<b>Optional: Hardware for 6 Meter Passive Element</b>			
Optional Bag	1	60-0003	1-3/4" U-Bolt & Saddle
	2	60-0014	6-32 Nut Nylok
	2	60-0011	6-32 x 3/4" Pan
	1	10-1029-01	Connector Protector (Blue Packet)

## LIST OF FIGURES

Figure Number	Page Number	Description
1	8	Boom sections
2	8	Boom splice
3	8	Aligning boom section
4	8	Fitting boom section
5	8	Tightening boom section
6	8	Connector protector
7	9	Yagi spacing and installation layout
8	10	Mast plate - pre-drilled holes
9	10	Connecting the mast plate
10	10	Connecting boom to mounting plate
11	11	Mounting EHU to boom bracket
12	11	Positioning director/reflector EHU's
13	11	Positioning the driven EHU
14	12	Controller front
15	12	Controller back (without transceiver interface)
16	12	Controller back (transceiver interface)
17	12	EHU 4 conductor cable & strain relief fitting
18	12	1 and 12 position terminal strips
19	13	Terminal strip wiring diagram
20	13	Completed terminal strip wiring
21	13	Positioning cables for terminal enclosure
22	13	Terminal enclosure tube and end cap
23	14	Mounting the terminal enclosure tube
24	14	Suggested coax routing drawing
25	15	Quick disconnect boots
26	15	Merco Electrical tape
27	15	20' and 10' silicone tape
28	15	Measuring the telescoping fiberglass poles
29	16	Taping telescoping pole joints with electrical tape
30	16	Taping telescoping pole joints with silicone tape
31	16	Side-by-side of new and original poles
32	17	Recommended lengths for silicone tape
33	18	EHU aluminum reinforcing rings
34	18	Installing quick disconnect boots to poles
35	18	Inserting telescoping poles onto EST
36	18	Correct positioning of quick disconnect boots
37	19	6 Meter passive element

## Assembling the Boom

The 3 element SteppIR Yagi boom consists of four (4) sections shown in **Figure 1**. The element mounting brackets are pre-installed at the factory. We double-check the fasteners for the proper tightness before shipping, but it is always a good idea to check them yourself before installing the antenna.

The boom is completely assembled and drilled at the factory to assure precision element alignment. You may notice in some cases that on a given splice (**Figure 2**) the holes on each side of the splice are at 90 degrees to each other. This is as designed and **not** a mistake. Pre-drilled holes are quite snug to align almost perfectly. In some cases you may find it necessary to assist the bolts with a tap of a hammer, or the preferred method which is to “thread” them in by turning with a wrench. If the holes are visibly out of alignment when you are assembling the boom, you probably have the boom pieces put together in the wrong order.

Each piece of the boom has a number permanently **written, scribed or stamped** on it (**Figure 2**). Match each number with the exact number of a corresponding boom piece. **Figure 7 on page 9** shows how each boom section is numbered. Connect the boom by sliding the respective sections together and align the pre-drilled holes (**Figure 3 & 4**). It is advisable to apply a very thin film of **connector protector** (**Figure 6**) or spray a small amount of WD-40 on the male sleeve before sliding the female section onto it. Do not twist the aluminum excessively, as this can cause binding.

**Note:** Put a small amount of **connector protector** or anti-seize grease on all bolts 1/4” or larger, especially on the U-bolts - it greatly increases their gripping power. Anti-seize grease (molybdenum based) is available at most auto part stores. **DO NOT** get any connector protector on any of the plastic parts!!

**Note:** The boom bolts need to have a total of five (5) flat washers on each bolt to prevent the nut from bottoming out at the end of the threads before it is too tight. The washers can be placed anywhere, but the recommendation is to put three (3) on the head side and two (2) on the nut side.

Insert the included bolts into the pre-drilled holes, adding the washers and tightening the Nylok nuts securely (**Figure 5**). Insert the bolt through the boom, orienting the head of the bolt on the bottom side of the boom, so that when the boom is mounted to the mast, the bolt head will be facing the ground. This will ensure that if the nut ever loosens the bolt will not fall out. (See **Figure 10 on page 10 for bolt head location**)

**Note:** Make sure the boom bolts for the center splice (#2) are installed as shown in **Figure 10 on page 10**. If you install them the opposite way the bolt will interfere with the mast plate.

**Figure 6**

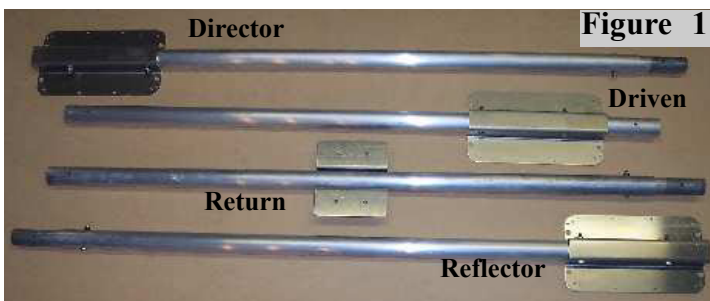

**Figure 1**



**Figure 2**



**Figure 3**



**Figure 4**

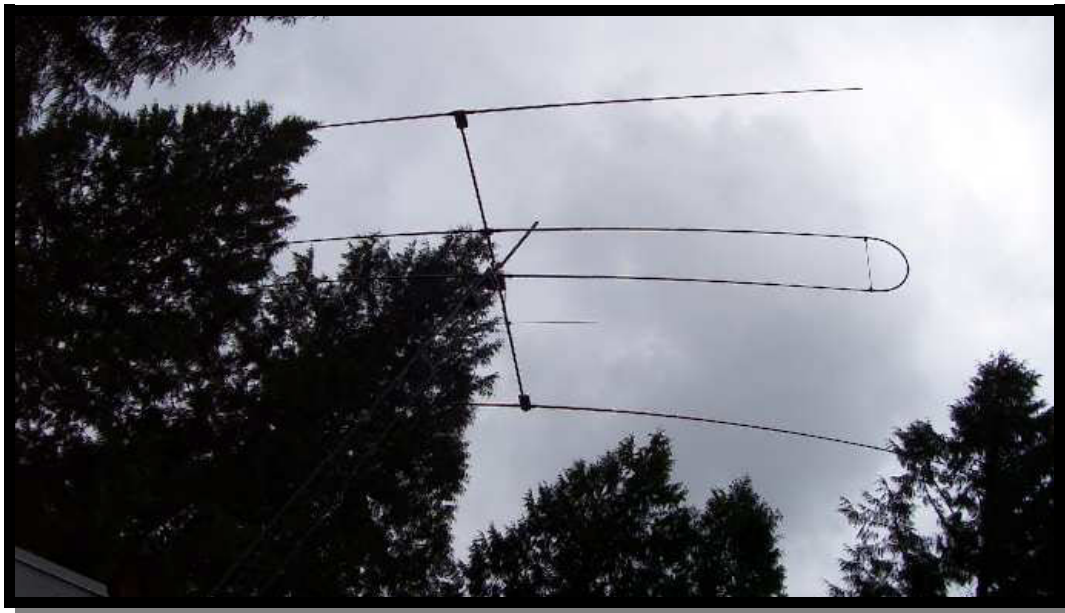
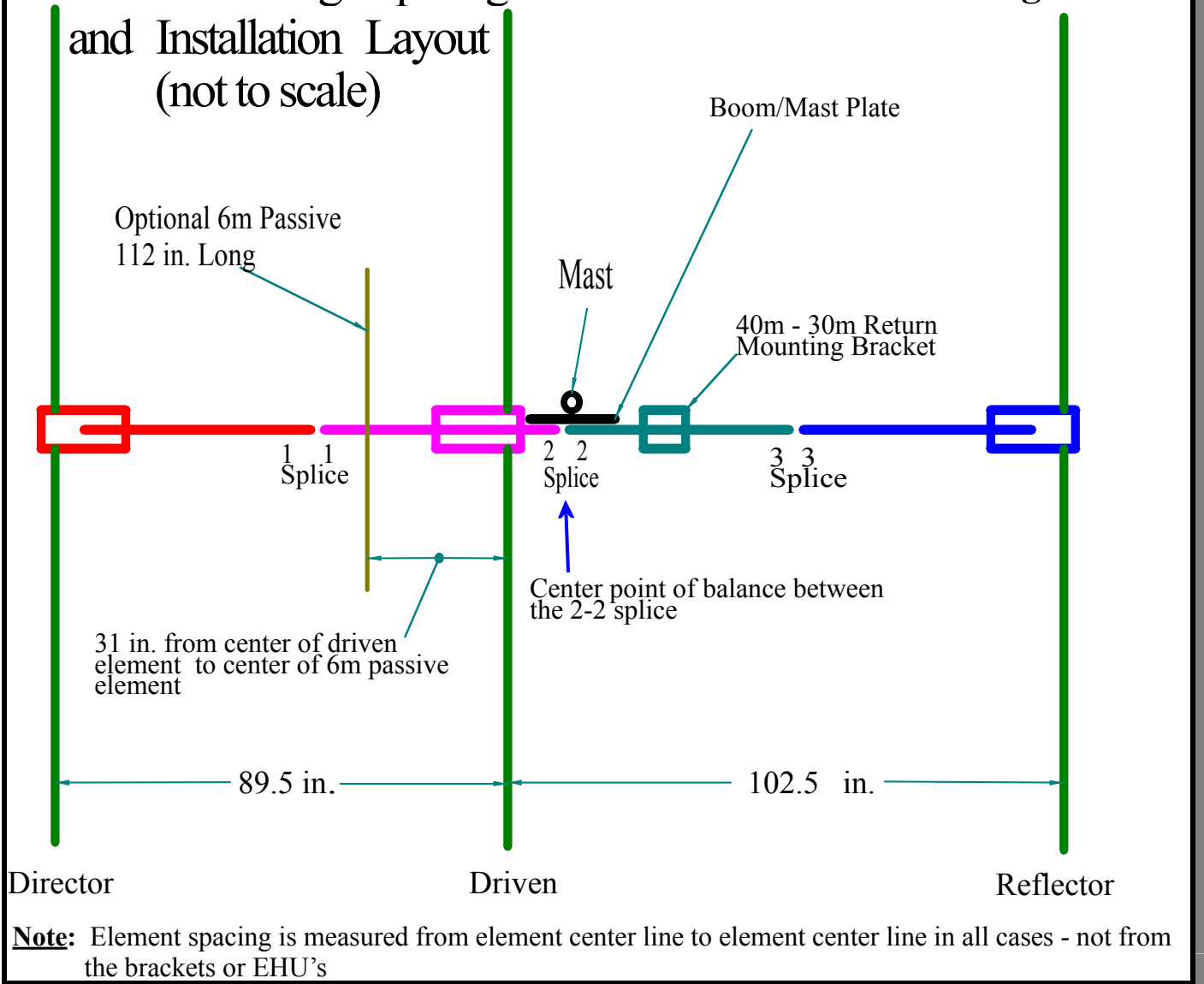

**Figure 5**



## 3 Element Yagi Spacing and Installation Layout (not to scale)

Figure 7



### Connecting the Boom to the Mounting Plate

The mast plate has a total of eight (8) pre-drilled holes (**Figure 8**). Four (4) are used for the 2" stainless steel mast clamps, and four (4) more are used for the 1-3/4" stainless steel boom clamps.

**Note:** If you are installing a 40m-30m Dipole kit, reference the 40m-30m instruction manual for proper mast plate placement.

If you are going to use a temporary mast during assembly, connect the mast plate to the mast using the included 2" stainless steel U-Bolts with saddles and Nylok nuts as shown in **Figure 9**. Tighten securely. When you are ready to mount to the mast, use the included 2" stainless steel U-Bolts with saddles and Nylok nuts as shown in **Figure 9**.

**Note:** If you are doing this on the tower it is advisable to test each U-bolt for a proper fit, and bend if necessary to ensure ease of assembly on the tower.

Connect the boom to the mounting plate on the opposite side of the mast (**Figure 9**), using the 1-3/4" U-bolts, saddles, and nuts. Align the boom so that the element brackets are level and facing up, then tighten securely. The center balance point of the boom is at splice #2, as shown in **Figure 10**. There will be a bolt on each side of the splice - **make sure that the nut end of the horizontal bolt is facing away from the mast plate (Figure 10)**. Otherwise, you will not be able to secure the boom snugly to the boom clamps. To ensure a balanced weight load, the center of the mast plate should be reasonably close to the center balance point of the boom.

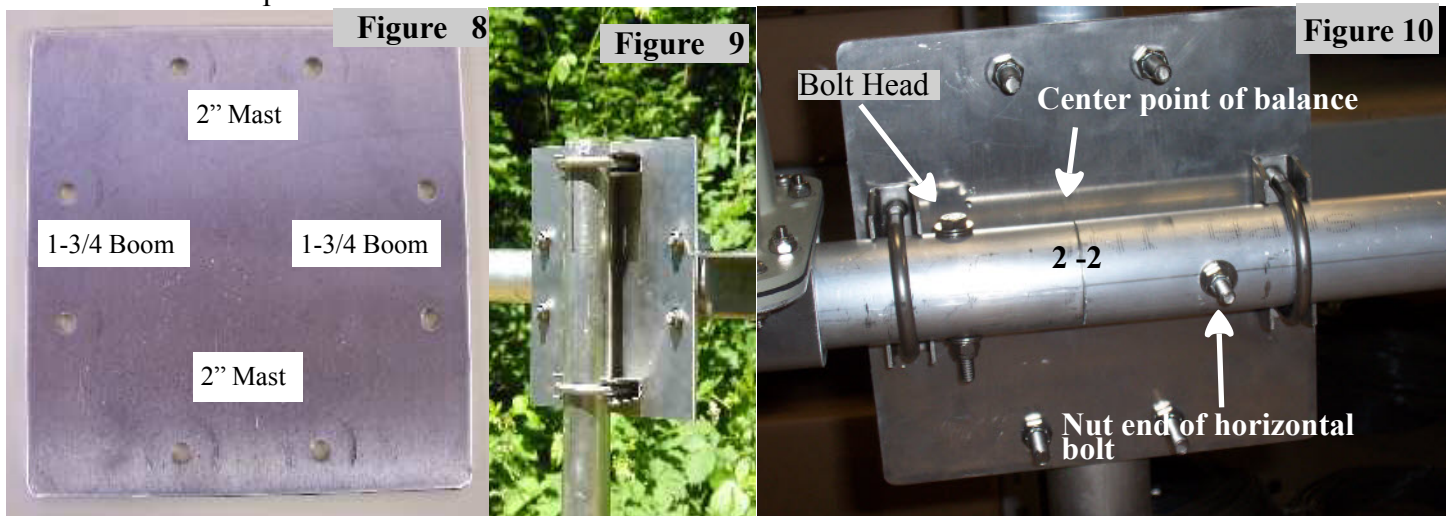

### Determining the direction of the Antenna

The SteppIR Yagi has three “directions” in which it can be used. **Normal**, **180 degree**, and **Bi-Directional**. This can make it complicated to describe the actual “aiming” direction of the antenna. When the antenna is installed on its mast, the passive element should be facing the direction the rotator indicates.

- In the **Normal** mode the forward, or “aiming” element is a director, and the element behind the driven is a reflector. While in the normal direction, the director is the element that is closest to the driven element (89.50” between the two).
- In the **180 degree** mode, we swap the reflector and director positions by changing their respective lengths, creating a new antenna based on the new element spacing.
- In the **Bi-Directional** mode, the antenna is directing RF in both directions.

## Attaching the Element Housing Unit (EHU) to the Element Bracket

Follow the instructions that came with the EHU for installing the gasket and cover on each of the EHU's, using the supplied screws and nuts. These EHU's will need four (4) 10-32 x 3/4"- B screws and four (4) 10-32 SS Nylok nuts for installing the gasket and cover.

Place the flat side of the of the element housing unit (EHU) on top of the element boom brackets (**Figure 11**), so the top of the EHU is facing up as illustrated in **Figure 24, page 14**.

**Note:** If the mounting holes for the EHU do not line up with the holes in the element bracket, it may be necessary to loosen the two horizontal bolts that hold the element bracket to the boom. After mounting the EHU to the element bracket be sure to re-tighten the two horizontal bolts.

The EHU's without the coax connector are the director and reflector (they are identical and interchangeable). The EHU with the coax connector is the driven element (there is a balun on the inside of this housing). The reflector and director should be positioned so the actual fiberglass pole is furthest away from the driven EHU (**Figure 12 & 24, page 14**). The driven element should be positioned so that the fiberglass pole is closest to the mast plate (**Figure 13 & 24, page 14**). Fasten each element housing to the element bracket, using the eight (8) 10-32 x 7/8" screws, flat washers and Nylok nuts. **The flat washer needs to be placed between the screw head and the plastic element housing.** Tighten securely, but not too tight (if you over-tighten the nut, you may split the plastic flange on the EHU). The olive green element support tube (EST) (**Figure 11**) on each EHU will appear uneven in length - it is actually centered on the inside of the antenna housing.

**Note:** The reflector element and the driven element will have the EST (offset tube) lined up so that the short side and long side of each EST are facing in the same directions. The director element EST configuration will be the opposite. This is normal.

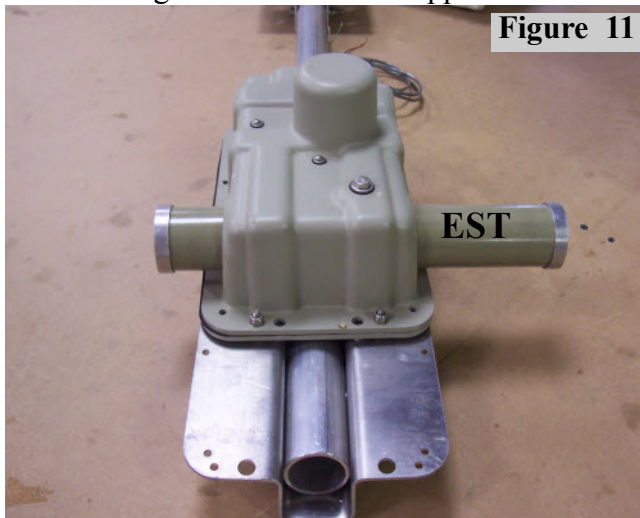

Figure 11

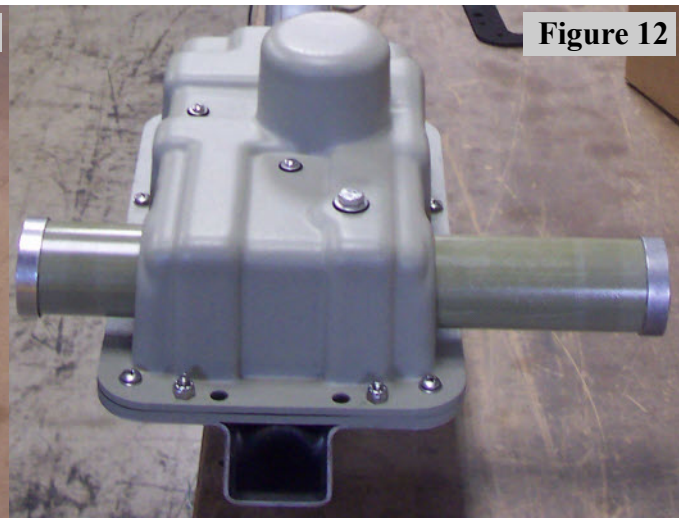

Figure 12

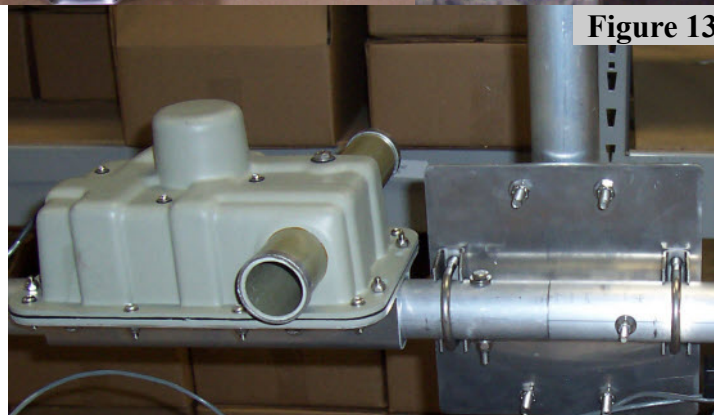

Figure 13



## Control Cable Wiring Instructions

**WARNING:** The controller has voltage present on the control cable wires, even when the power button has been pushed to “Off”. Unplug the power supply and disconnect the 25-pin D-sub connector before making any connections or cutting or splicing the cable wires. If the controller has power and the control cable wires short out, this will damage the driver chips inside the controller.

**Note:** If you have more than 200’ of control cable you must use our optional 33 VDC power supply. This will then allow up to 500’ of control cable without any problems.

**Be sure** to connect the controller case to your station ground using the #8-32 lug on the back of the controller. This is important for RFI immunity as well as lightning protection. **Figures 14-16** show the front and rear of the controllers. If you are in a high lightning area, take the appropriate precautions, as the controller can be damaged by lightning. (It is beyond the scope of this manual to cover all of the complexities of lightning protection; see some of the ARRL publications that address this). The surest protection is to disconnect the power supply first and then the 25-pin D-sub connector, then move them well away from the controller.

Each EHU will have a 9’ 2” length of 4 conductor cable attached to it using a waterproof strain relief fitting (**Figure 17**). Mark each cable coming from the appropriate EHU; this will assist you in properly identifying the control cable with each EHU (i.e. Director, Reflector, Driven). There will be a 12 position terminal strip included with the antenna, and a single position terminal strip for the ground connections as shown in **Figure 18**. First, dip each bare wire into the provided blue connector protector pouch (**Figure 6, page 8**). Connect each wire of the 4 conductor cable to its respective location on the 12 position terminal strip (**Figure 19 & Figure 20, page 13**). Repeat this on the opposite side of the terminal strip for the 12 conductor cable as well. Each cable (all three sets of the 4 conductor cables and the 12 conductor cable) will have a silver ground wire. Connect all three EHU ground wires to one side of the single terminal strip, and the 12 conductor cable ground wire to the other side (**Figure 19 & Figure 20, page 13**).

Protect the wire that is coming from the each of the EHU’s. This is important. Our recommendation is to tape the wires to the side of the boom and about every 1 ½ feet to 2 ft along the boom. It is also recommended to leave a little slack in the wire, so that the wire is coming down from the housing to the boom and if there is any moisture present it will drain down and not get inside the EHU.

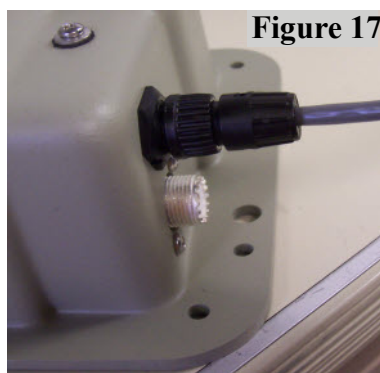
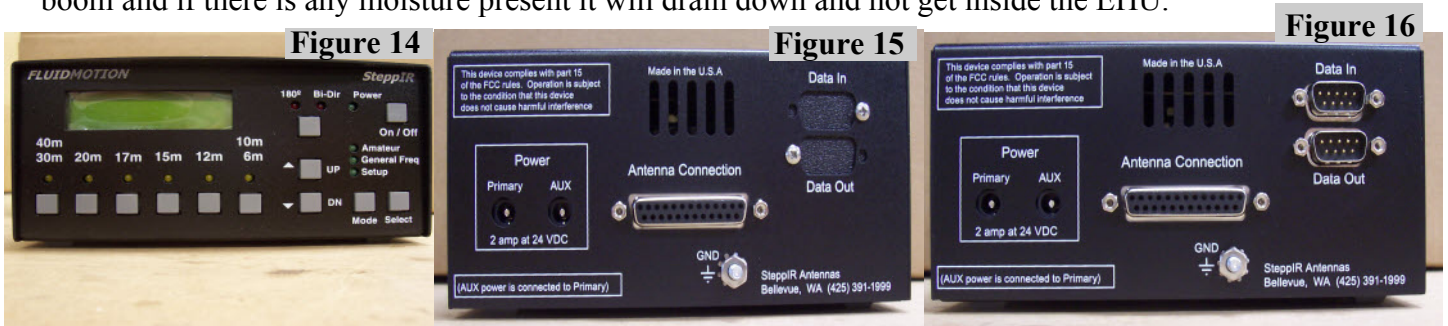
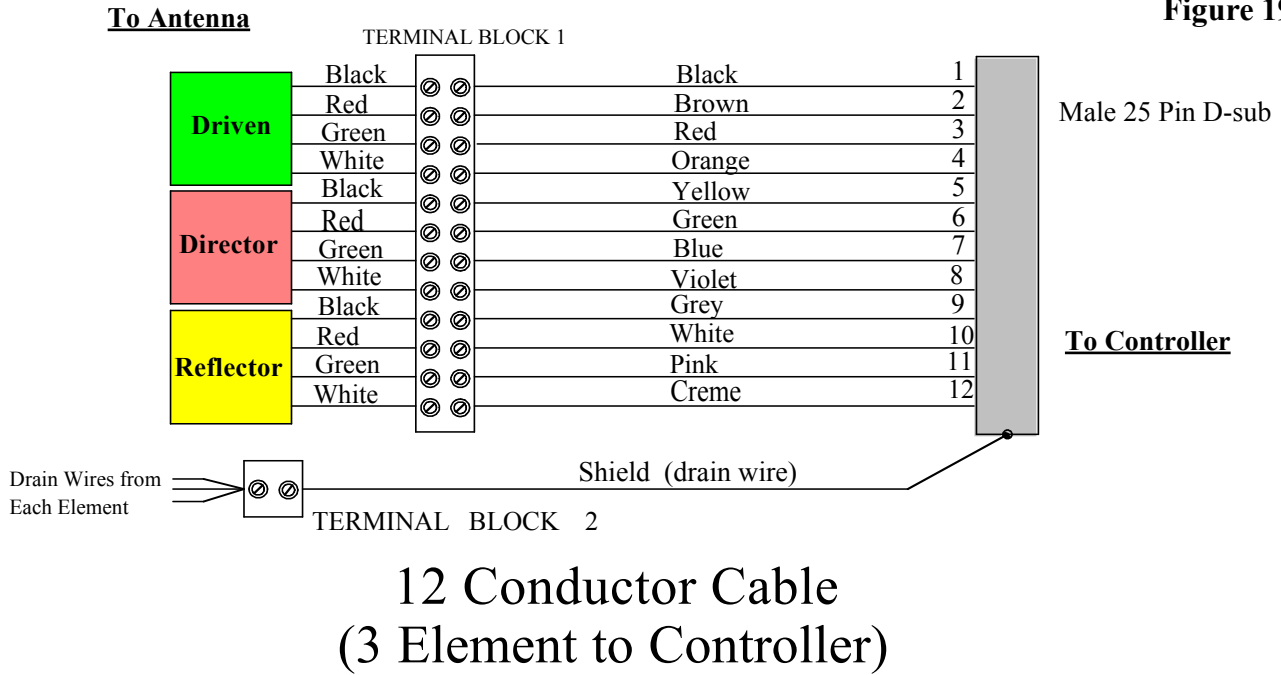
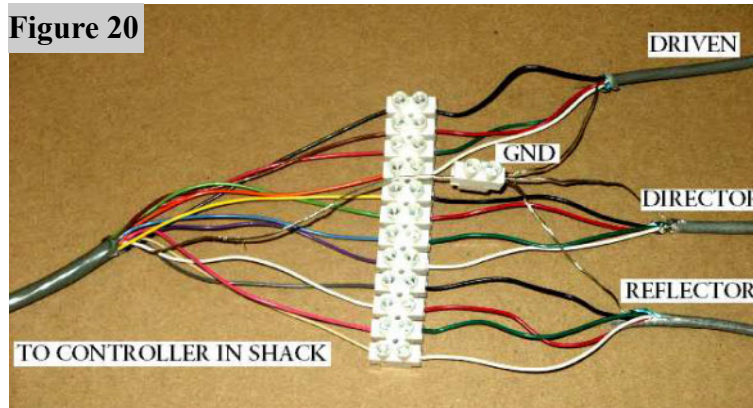

Figure 19



**Warning:** Look carefully at the order of the elements on the terminal block. Make sure that all wires are connected to the terminal block properly and securely. Make sure that there are not any exposed wires.

Figure 20



When the connections have been secured, position the cables so they are parallel with the 12 position terminal strip (**Figure 21**). The 12 conductor cable will be at one side, and there will be three (3) sets of 4 conductor cables at the other. Slide the cables and terminal strips into the provided terminal enclosure tube (**Figure 22**). Position the cutout in the threaded cap over the cables and screw the enclosure onto the cap.

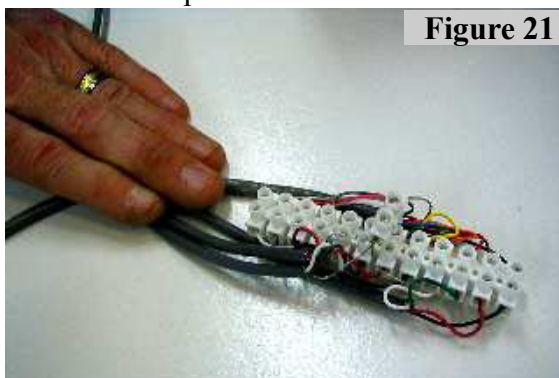

Figure 21



Figure 22



### Attach the Wiring Enclosure to the Boom or Mast

Position the terminal enclosure in a convenient position **on the boom or mast** making sure that the cut out in the cap is facing downward (**Figure 23**). **Do not** seal the enclosure, so that in the event there is water accumulation inside, from condensation, it will be able to escape. Fasten the enclosure to the boom using the screw clamp, taking care to not trap the cables in-between. Secure the cables to the boom every foot or so. The terminal housing mounting location is not critical. It can be mounted on the boom horizontally or vertically on the mast-whatever works the best for your installation. Tape the control cable to the boom approximately 8" from the coax connection (**Figure 24**). Tape the coax and the control cable together, and run them down the tower to the controller and radio.

**Note:** Be careful **NOT** to tape the cables over a sharp edge unless you provide extra protection to prevent cutting through the sheath and shorting the wires.



Mount Horizontal or Vertical

**Warning:** We strongly recommend that you perform the "Test Motor" procedure at this point, to verify the wiring is correct and the elements are in the right location (refer to the *Operators Manual*, page 9). If you are **not** going to connect the control cable and test it on the ground, **make sure** the element control cables are positively identified and well marked. If you get the elements mixed up on the terminal block you will get very confusing results such as high SWR, low performance, etc. Mark them **before** you tape them along the boom; it is very easy to get two parallel wires mixed up. Now, when you are on the tower, it will be easy to positively identify each element control cable.

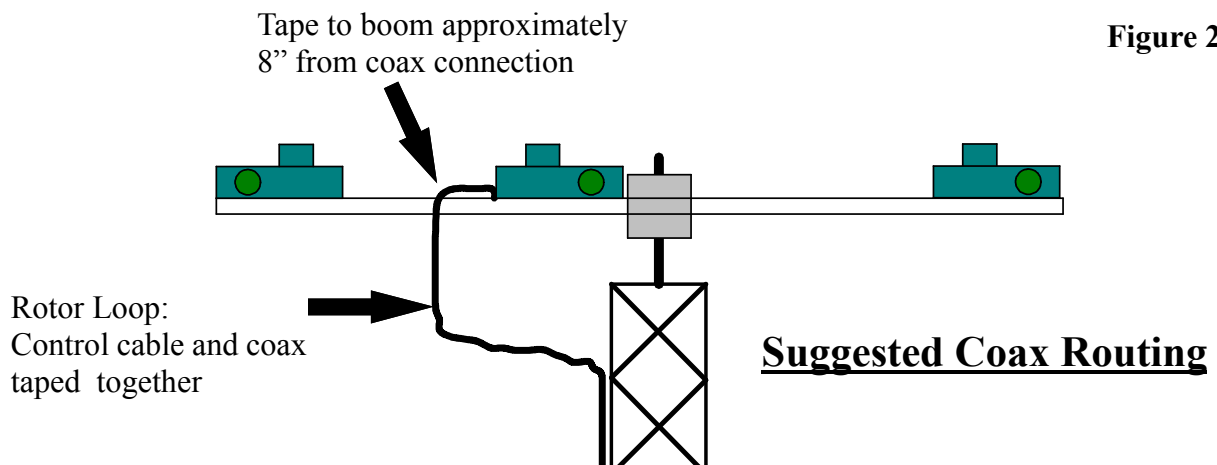

## Preparing the Telescoping Poles

**Note:** If you have ordered the optional 40m - 30m Dipole Kit, refer to the section on preparing the telescoping poles in the 40m-30m manual. The 4 special poles for this option have some differences from the standard poles.

### Locate:

- Six quick disconnect boots (rubber) (Figure 25)
- Roll (s) of black electrical tape (Figure 26)\*
- Roll (s) of black silicone self-curing tape (Figure 27)\*
- Six dark green fiberglass telescoping poles (Figure 28)\*\*
- Your tape measure
- Scissors

\* The quantity of tape provided will depend on the number of elements.

	<u>Normal</u>	<u>W/Optional 40-30 Dipole</u>
**	3 Element - 6 poles	4 Normal & 4 Special (8 total)

**Note:** The reinforcing rings/sections on the first two pole sections provide extra strength in potential high wind conditions (Figure 31, page 16).

The green fiberglass poles are all assembled in the same manner, and when extended keep the copper-beryllium tape safe from the weather. The copper-beryllium tape is shipped retracted inside their respective element housing units (EHU's).



## Repeat the following procedure for each telescoping pole

Telescope a pole to full length by pulling each section out **firmly** in a twisting motion until it is extended as far as possible. **Each segment is tapered and should lock securely in place when fully extended.** Pole lengths may vary, but when they are fully extended each pole must be at least **17 feet 8 inches** in length as measured from the butt end of each pole to the tip (Figure 28). **Verify the length for each pole before installation or wrapping the joints.**

If a pole comes up a little short (1/2" to 1"), try collapsing the pole and starting over. Aggressively "jerk" each section out instead of twisting. The pole cannot be damaged and you may gain a minimum of 1/2" or more. If you have trouble collapsing the pole, try carefully striking one end on a piece of wood or other similar surface placed on the ground.

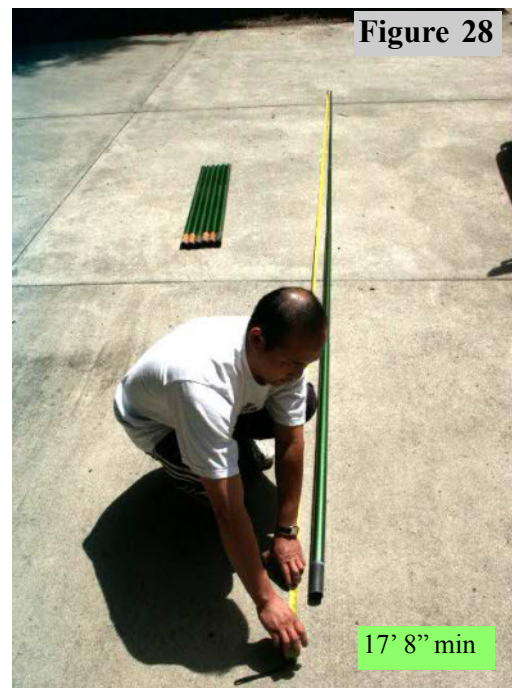

At the factory, we quality check the poles to verify that they meet minimum length by holding the butt (large) end and whipping it, as if casting a fishing pole, but with considerable force. This procedure can produce a significant difference in the extended length of some poles.

**DO BE CAREFUL !!!**

**Warning:** Make sure to remove the black rubber plug from the base section of each of the telescoping poles. This is a shipping plug and will seriously damage the copper-beryllium tape and drive mechanisms if not removed.

Check all six sections of each pole for packing popcorn or any other foreign object that could interfere with the copper tape movement.

There are foam plugs glued in the small end of each of the dark green telescoping poles. These plugs allow the poles to breathe and prevent the buildup of condensation inside. Do NOT remove, block, cover, plug, cap or in any way inhibit air flow through this foam plug filter.



Figure 29



Figure 30

**Note:** The telescoping poles will not all be the same length. This is not a problem as long as they are a minimum of 17' 8". They are interchangeable and can be used in any normal element position.

Next, wrap each joint on the fiberglass poles with the all weather electrical tape (Figure 29.) Each joint should have at least the full width of the tape on both sides of the joint. Use common sense on the amount of tape, or you will not have enough of the silicone tape that is used later to cover the electrical tape.



Figure 31

**Exception:** On joints with metal reinforcing rings (Figure 31,) the tape must go further so it extends a minimum of 3/4" beyond the metal ring and onto the fiberglass pole.

Apply one complete wrap of electrical tape around the fiberglass pole as you begin, and then work your way across the joint and back using half overlap wraps, **so that the entire area is seamlessly covered.** Carefully stretch and smooth the tape with your fingers as you apply it, especially when you change directions - this will help avoid ripples and have the tape lie as smoothly as possible. When you are at the end of the run, cut the tape with a knife or scissors and press the end onto the pole. Then run your hand over the tape a couple of times to firm up the bonding.

Figure 32

### Recommended Lengths for Silicone Tape

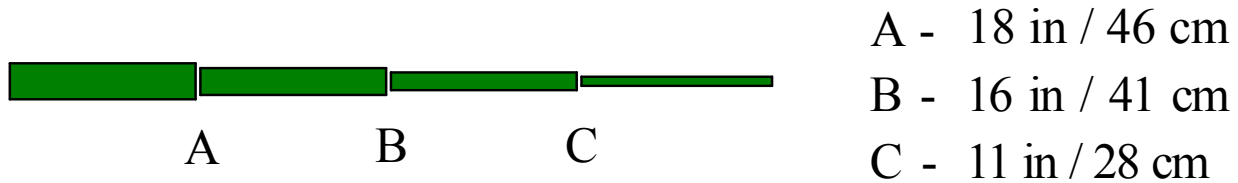

Next, weatherproof and UV protect each joint with the black self-curing silicone tape (**Figure 27, page 15.**) **It is important that you pre-cut the silicone tape to the recommended lengths.** If you do so, you will have more than enough for each joint. Refer to **Figure 32** for proper lengths for each joint. In the event you require more silicone tape, you can order more from SteppIR. Sometimes it can be found at a hardware store or a marine supply store.

**IMPORTANT:** Per the manufacturer's specifications, unused silicone tape has a shelf life of 12 months. Store in a cool, dry environment. Silicone tape will not stick to just any surface. **It only bonds to itself.** Be sure to remove all the connector protector residue from your hands before handling the silicone tape, as that residue will cause the silicone wrap to not to adhere to itself in places. Take care to keep the silicone wrap free of dirt or debris. Also, this tape must be cut. **Do not tear it.** Wash your hands before completing the steps.

Position the black silicone tape about 1/2" to the right of the black electrical tape and wrap one layer, **continually stretching the silicone tape a minimum of 100 % its original length,** completely around the pole so the tape fully overlaps itself. Then slowly wrap the silicone tape to the left using half overlap wraps, extending about 1/2" beyond the black electrical tape. When you reach the end, wrap one layer completely around the pole so the tape fully overlaps itself just as you did at the beginning of the wrap. If you are stretching the tape correctly you will get about two layers of tape at each joint. As before, carefully stretch and lay the tape down as smooth as possible. The final joint should look like **Figure 30.**

**IMPORTANT:** After the silicone tape has been applied, be sure to rub each wrap with your hand several times to ensure that it is flat and has adhered to itself.



## Attach the Fiberglass Telescoping Poles to the Element Housing Units (EHU's)

The butt ends of the telescoping fiberglass poles may vary slightly in outside diameter. Some of them may have been sanded, while others were not. The colors at the ends will be either natural or black. The difference in colors has no affect on performance. Do not be concerned if they vary slightly in tightness when being installed on the EHU's. This is normal. All poles are tested at the factory prior to shipping. In the event the pole won't fit, it is okay to sand it.

The EST's on the EHU's have aluminum reinforcing rings attached to provide extra strength in high wind conditions. The current production of antennas have the narrower aluminum ring as shown in **Figure 33**.

Locate the six quick disconnect boots and repeat the following procedure for each of the six fiberglass telescoping poles.

- Place the narrow end of a quick disconnect boot onto the butt end of a telescoping pole. Slide it in about 6" onto the EST (**Figure 34**.)
- Insert the butt end of that telescoping pole into one of the EST's on an EHU, as shown in **Figure 35**. **It is very important to ensure that the butt end of the telescoping pole firmly bottoms out inside the EST.** Make sure the telescoping pole is seated all the way into the EST. Then **push the rubber boot down onto the fiberglass EST until the hose clamp is past the aluminum ring and will clamp down onto the fiberglass EST.** The correct mounting position of the quick disconnect boot is shown in **Figure 36**. This ensures that the hose clamp can grip onto both the fiberglass and the ring, so that it will prevent the rubber boot from ever coming off.
- Firmly tighten both stainless steel hose clamps, one over the telescoping fiberglass pole, and the other over the EST. Then test the connection by pulling and twisting it. There should be no slippage at the joints.

**NOTE:** You should re-tighten each clamp a second time (at least 30 minutes after the first time you tightened them) before raising the antenna to the tower, to be sure that there has been no cold flowing of the PVC material on the rubber boot.

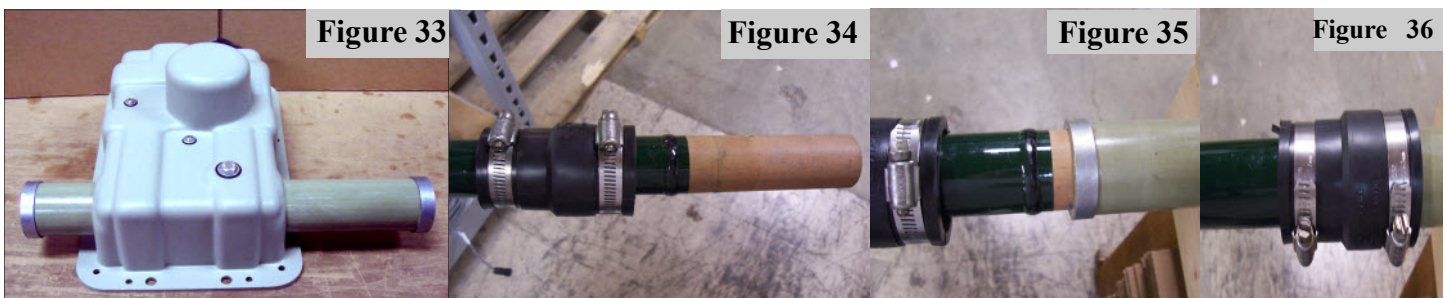



## 6 Meter Passive Element (Optional)

Each 6 meter passive element comes in 3 pieces; the main body with a 1/2" x 58" element section attached to it, and two (2) 3/8" element sections (**Figure 37.**) The overall length of the element is approximately 112" when assembled.

Use a small amount of the included connector protector solution when connecting the two sections of tubing. Slide in the short ends of the 3/8" tubing (the end that has the least amount of distance from the edge of the tubing to the drilled hole) and align the holes. Install the 6-32 x 3/4" machine screws and Nylok nuts and tighten securely.

The 6 meter aluminum element mounts between the driven element and the director (the elements that are approximately 89" apart). The center of the 6m element should be 31" from the center of the driven element (see **Figure 7, page 9**). Fasten securely to the boom using the 1-3/4" SS U-bolt, saddle and hardware. Make certain that you have the 6 meter passive element level with the other elements.

**Warning:** When attaching the 6m passive to the boom be careful not to trap the element control cable under the U-bolts.

**Note:** You will need to enable the 6 meter passive in the controller. Reference the "Operators manual" under "General Frequency Mode" - "Options Menu" - "6 meter Passive Selection".

When you are using the 6 meter band, keep the antenna in the forward direction and rotate accordingly. Optimum performance will be from 50.000 MHz to 50.500 MHz. The 180 degree mode is exactly the same as the forward mode since we have no choice when the aluminum passives are used. However, the Bi-Directional mode works to the same degree by directly reducing the front to back ratio.



**Figure 37**

## SteppIR Options

- 40m - 30m Dipole (loop)

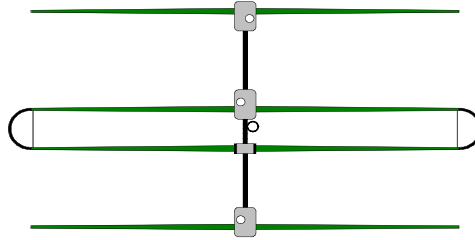

- "Y" Cable



- Transceiver Interface Cable (Rig Specific)



Transceiver Interface

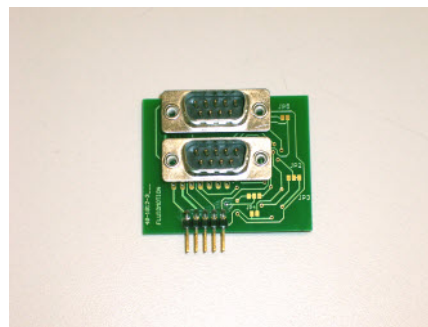

□ **6m Passive Element Kit**



□ **Voltage Suppressor & RF Bypass Unit**  
( 12 Conductor)



□ **Element Expansion Kit**

3 Element to 4 Element



### L i m i t e d   W a r r a n t y

These products have a limited warranty against manufacturer's defects in materials or construction for two (2) years from date of sale. Do not modify this product or change physical construction without the written permission of SteppIR Antennas Inc. This limited warranty is automatically void if the following occurs: improper installation, unauthorized modifications, physical abuse or damage from severe weather, beyond the manufacturer's control.

Manufacturer's responsibility is strictly limited to repair, or replacement of defective components. The shipping instructions will be issued to the buyer for defective components, and shipping charges will be paid for by the buyer to the manufacturer. The manufacturer assumes no further liability.

# SteppIR<sup>TM</sup> Antenna Systems

## Yagi Dipole Vertical

(Patented)

www.steppir.com

Specifications	Dipole 1/2 Wave	MonstIR Dipole	2 Element Yagi	3 Element Yagi	4 Element Yagi	40m - 30m Dipole Adder	BigIR III Vertical <sup>3</sup>	Small IR Vertical <sup>3</sup>	MonstIR Yagi
Weight	→ 11 lb / 5 kg	68 lb / 30.8 kg	30 lb / 13.6 kg	51 lb / 23.1 kg	91 lb / 41.3 kg	7 lb / 3.2 kg <sup>4</sup> <sub>5</sub>	15 lb / 6.8 kg	12 lb / 5.4 kg	260 lb / 112 kg
Max. Wind Surface Area	→ 1.9 ft <sup>2</sup> / 0.17 m <sup>2</sup>	6.5 ft <sup>2</sup> / .61m <sup>2</sup>	4.0 ft <sup>2</sup> / .37m <sup>2</sup>	6.1 ft <sup>2</sup> / 0.57 m <sup>2</sup>	9.7 ft <sup>2</sup> / 0.90 m <sup>2</sup>	2.0 ft <sup>2</sup> / .19 m <sup>2</sup> <sup>4</sup>	1.9 ft <sup>2</sup> / .17 m <sup>2</sup>	1.0 ft <sup>2</sup> / 0.9 m <sup>2</sup>	23.9ft <sup>2</sup> / 2.22m <sup>2</sup>
Wind Rating	→ 100 MPH EIA-222-C	100 MPH EIA-222-C	100 MPH EIA-222-C	100 MPH EIA-222-C	100 MPH EIA-222-C	100 MPH EIA-222-C	75 to 125 MPH With Guys <sup>6</sup>	100 MPH EIA-222-C	100 MPH EIA-222-C
Longest Element	→ 36 ft / 10.97 m	70 ft / 21.5 m	36 ft / 10.97 m	36 ft / 10.97 m	36 ft / 10.97 m	39 ft / 11.9 m	32 ft / 9.75 m	18 ft / 5.49 m	70 ft / 21.5 m
Power Rating	→ 3000 Watts Key Down	3000 Watts Key Down	3000 Watts Key Down	3000 Watts Key Down	3000 Watts Key Down	3000 Watts Key Down	3000 Watts Key Down <sup>8</sup>	3000 Watts Key Down	3000 Watts Key Down
Boom Length	→ —	—	57 in / 1.44 m	16 ft / 4.87 m	32 ft / 9.75 m	—	—	—	34 ft / 10.46 m
Boom Diameter	→ —	—	1.75 in / 4.5 cm	1.75 in / 4.5 cm	2.50 - 1.75 in / 6.35 - 4.5 cm	—	—	—	2.75 - 2.50 in / 7 - 6.35 cm
Mast Diameter	→ 1.75 in / 4.45 cm	2.0 in / 5.08 cm	2.0 in / 5.08 cm	2.0 in / 5.08 cm	2.0 in / 5.08 cm	—	1.5 in / 3.81 cm	1.5 in / 3.81 cm	2.0 in / 5.08 cm
Frequency Coverage	→ 20m - 6m <sup>9</sup> Continuous	40m - 6m <sup>9</sup> Continuous	20m - 6m <sup>9</sup> Continuous	20m - 6m <sup>9</sup> Continuous	20m - 6m <sup>9</sup> Continuous	40m - 6m Continuous	40m - 6m Continuous <sup>3</sup>	20m - 6m Continuo	40m - 6m Continuous
Turning Radius	→ 18 ft / 5.48 m	35 ft / 10.7m	18.15 ft / 5.53 m	19.7 ft / 6 m	24.1 ft / 7.35 m	<sup>7</sup>	—	—	39.7 ft / 12.2m
Cable Requirements (shielded)	→ 4 conductor 22 AWG	4 conductor 22 AWG	12 conductor 22 AWG	12 conductor 22 AWG	16 conductor 22 AWG	—	4 conductor 22 AWG <sup>2</sup>	4 conductor 22 AWG	16 conductor 22 AWG
Tuning Rate	→ 1.33 ft / sec .40 m/sec	1.33 ft / sec .40 m/sec	1.33 ft / sec .40 m/sec	1.33 ft / sec .40 m/sec	1.33 ft / sec .40 m/sec	1.33 ft / sec .40 m/sec	.665 ft / sec .20 m/sec	.665 ft / sec .20 m/sec	1.33 ft / sec .40 m/sec
Balun Included?	→ No (optional)	Yes	Yes	Yes	Yes	Yes	No (optional)	No (optional)	Yes

1

Available as stand alone or optional upgrade to 2, 3 & 4 Element Yagi's. The option allows the driven element only to operate on 40m - 30m using the same feed line

2 12 conductor if optional 80m coil is added

3 An optional 80m coil may be added to the BigIR

4 Values add to the applicable antenna

5 17 lb / 7.7 kg for the 4 element

6 Reference assembly manual for details

7

Stand alone 1/2 Wave Dipole turning radius = 19.5 ft.

Adding 40m - 30m Kit - the 2 E turning radius = 20.0 ft.

Adding 40m - 30m Kit - 3 E & 4 E turning radius unchanged

Adding 40m - 30m Kit - 3 E & 4 E turning radius unchanged

1500 Watts on (3.5 MHz - 6.8 MHz) using loading coil

3000 Watts from 6.8 MHz up

9 20m - 30m coverage can be added at extra cost. Yagi performance on

40m - 6m is unchanged an driven element functions as a dipole on

40m - 30m



# Thank you for choosing SteppIR!!



**SteppIR** <sup>TM</sup>  
**Antenna Systems**

Yagi Dipole Vertical

[www.steppir.com](http://www.steppir.com)