

SteppIR™ **Antenna Systems**

Yagi • Dipole • Vertical (Patent #6,677,914)

40m - 30m Dipole Kit

Instruction Manual for the 2-3-4 Element Yagi

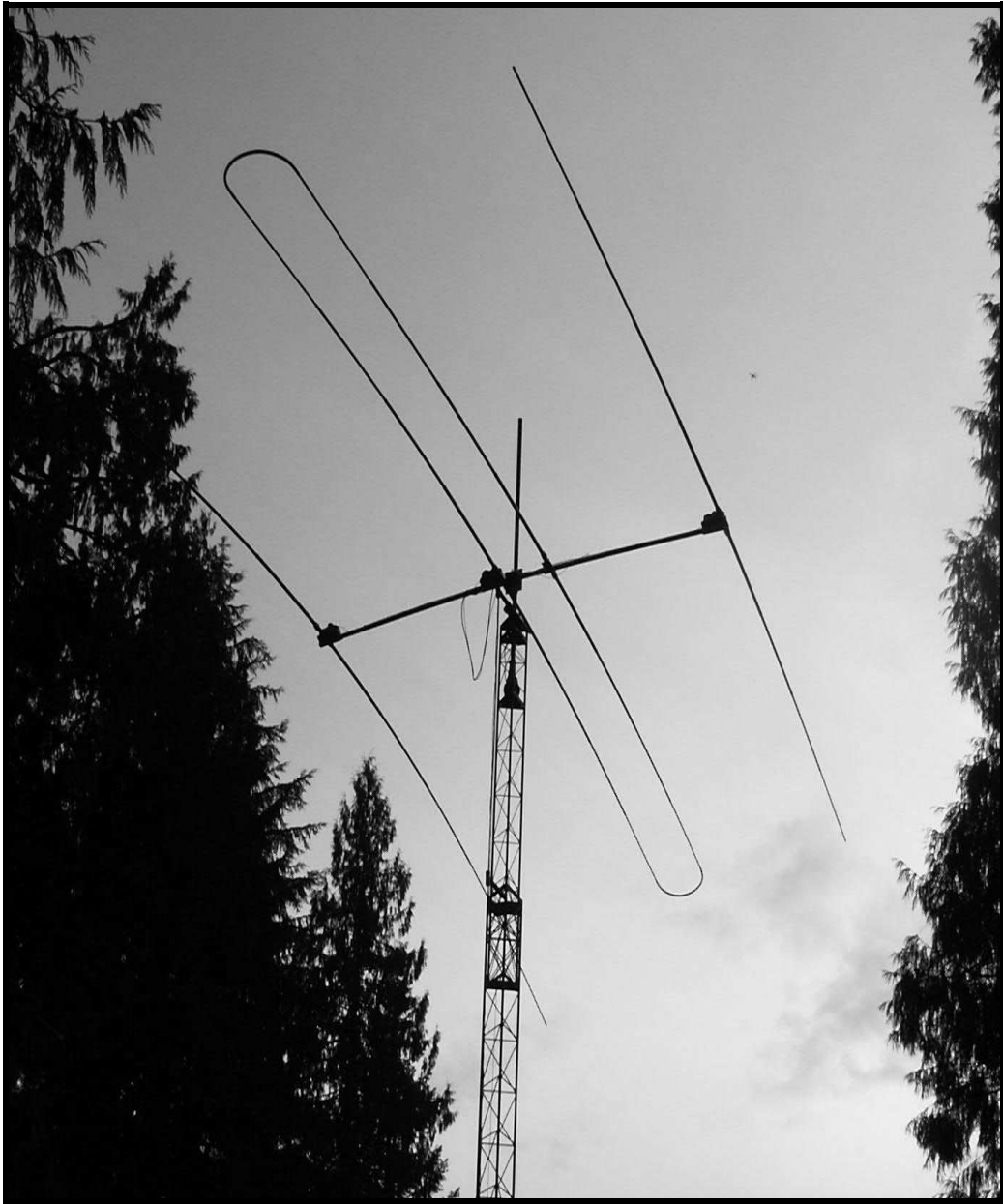

SteppIR Antennas

2112 -116th Ave NE, Suite 2-5 , Bellevue, WA 98004

Tel: 425-453-1910 Fax: 425-462-4415

Tech Support: 425-891-6134

www.steppir.com

Rev: Q 01/16/08

Abbreviations

EST	Element Support Tube
EHU	Element Housing Unit
FTP	Fiberglass Telescoping Pole
QDB	Quick Disconnect Boots (rubber)
ERT	Element Return Tube

EST



EHU

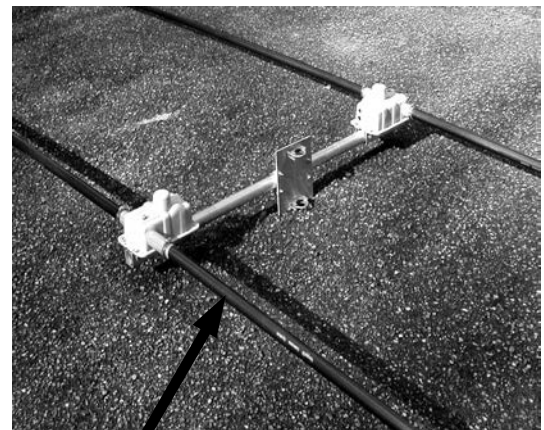

FTP

QDB

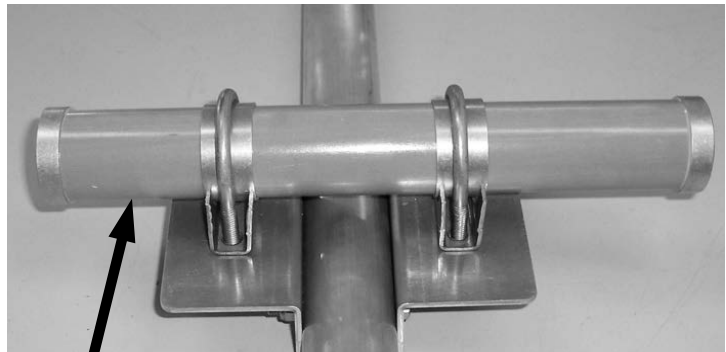
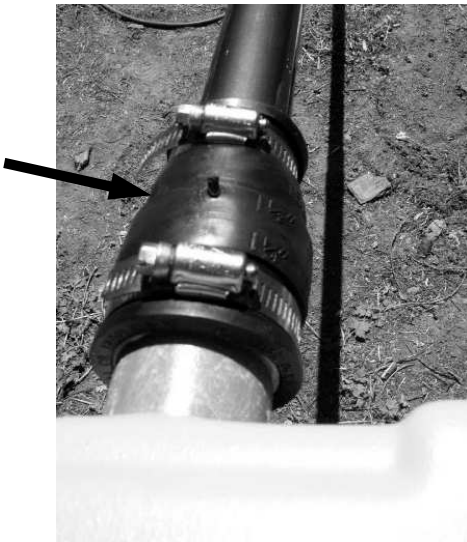

ERT

SteppIR Antenna Information Web Sites (as of 8/03/06)

<http://steppir.com/>

<http://groups.yahoo.com/group/steppir/>

40m - 30m Dipole Overview

The 40m - 30m dipole is simply a driven element that functions as a dipole from 6.8 MHz to 13.8 MHz and as the driven element for the yagi array from 13.8 MHz to 54 MHz. It has no effect on the performance of the yagi. The yagi works the same with or without this option. A dipole for 40m would normally be about 64 feet long but we have shortened it to 39 feet by looping the element tip back towards the boom. This is a form of linear loading and is very efficient, however, nothing comes for free and with this dipole you lose about .37 db on 40m over a full size dipole. This is hardly measurable at the receiving station end so it is a very reasonable trade off. On 30m since the copper tape barely turns the corner back toward the boom it essentially performs like a full sized dipole.

On 40m folding the element back nearly double (the tape comes within about 3.5 feet of the boom on each side) very conveniently makes the impedance 25 ohms, a 1.0:1 match for our yagi Balun/Unun. On the 30m, however, we have a full sized dipole whose impedance is very much dependant on the height above ground so there is a varying degree of mismatch. Below 40 feet or so you will find the SWR as high as 2.6:1 but at greater heights it can drop to as low as 1.6:1 SWR.

This small amount of mismatch can easily be handled by the internal tuners on most transceivers. At 10 MHz SWR values in this range result in insignificant loss, so the antenna will perform very well on 30m. You will find that on 40m even at heights below 40 feet you will get a very good match with this type of shortened dipole. If the SWR seems to be too high try adjusting the driven element length using the "Create Modify" function.

Note: By using the "Create Modify" function to fully extend either the reflector or director 1 on 30m you can create a very short director for the dipole resulting in .5 db gain and lowering the SWR by about .2. You can then save it and it will be permanent. You could also save it in both directions (180° and normal), lengthen the reflector in the 180° and the director 1 in the normal direction and now have it reversible. If SWR is the biggest concern try lengthening both the reflector and director 1 to get the lowest SWR.

Warm Regards,

Mike Mertel

*Michael (Mike) Mertel - K7IR
President*

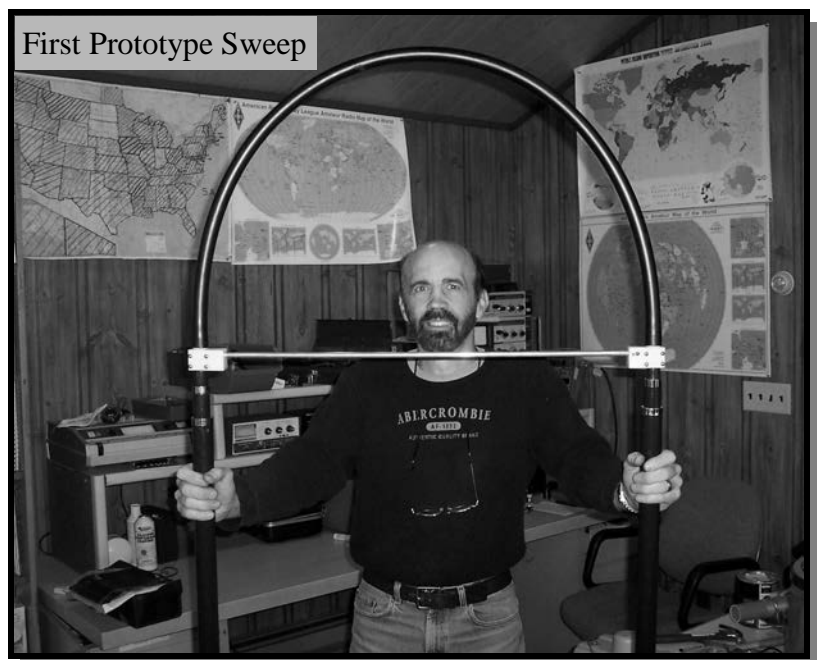

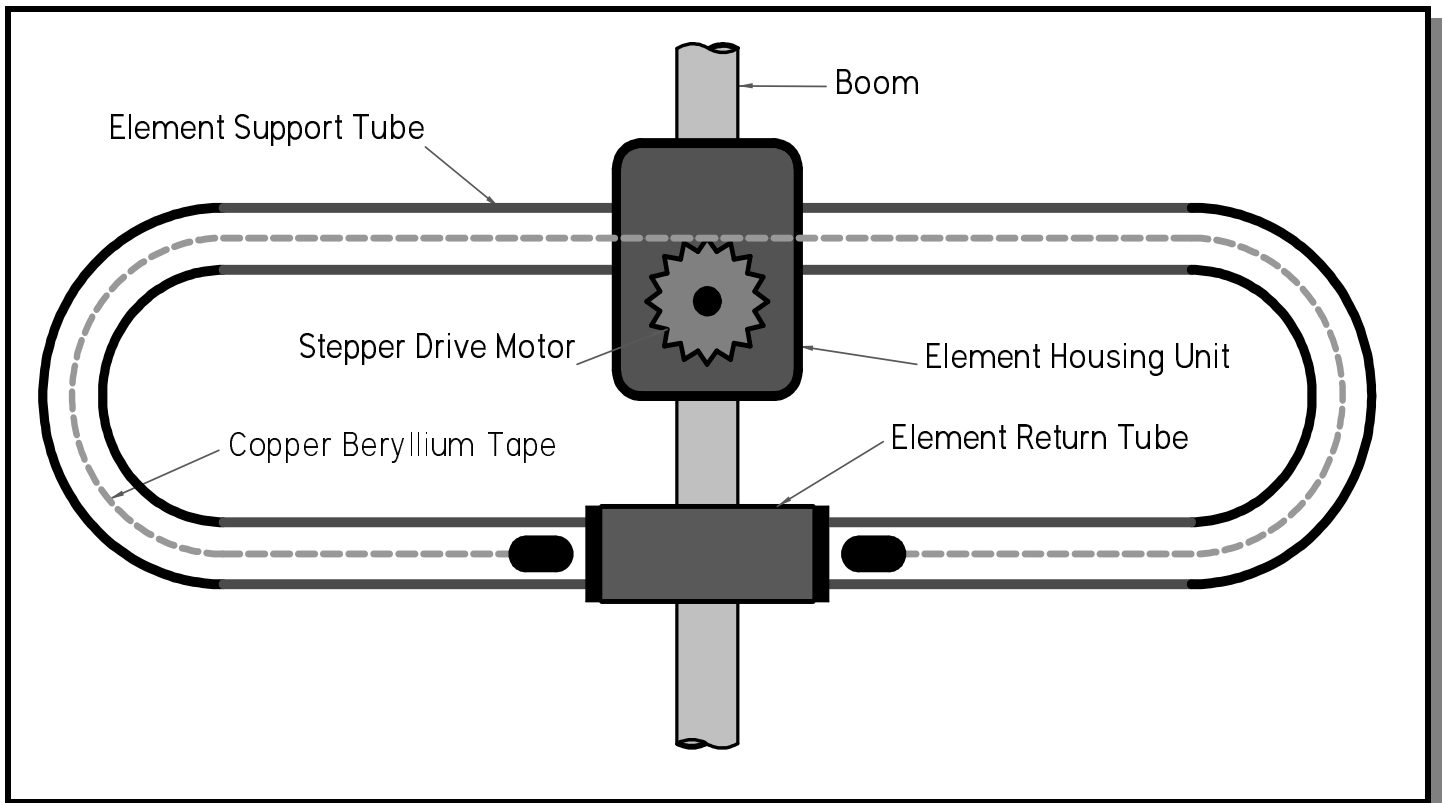

Table of Contents

<i>Topic</i>	<i>Page</i>
Abbreviations	2
40m - 30m Dipole Overview	3
Table of Contents	5
Parts List	6
For Upgrade of Existing Antenna	
Remove Existing Driven Element - 2 Element	7
- 3 Element	8
- 4 Element	9
Install 40m - 30m Return Loop	
Install the Element Return Mounting Bracket	10
Assemble the Return Mounting Kit	11
Install Boom Counter-weights (4 Element Retrofit ONLY)	12
Install the Element Housing Unit	14
Install CPVC Liner Tubes	14
Prepare the Fiberglass Telescoping Poles (FTP)	16
Assemble the Sweeps to the Poles	18
Attach the 40 - 30 EST's to the EST & ERT	21
Antenna Layout Drawing - 2 Element	22
- 3 Element	23
- 4 Element	23
New Antenna Specifications	24
Appendix A - 6m Passive (Early 3 Element Reconfiguration)	25
Appendix B - Controller (Upgrade)	26
Appendix C - CPU (Firmware chip) Replacement Procedures	27
Appendix D - Controller Firmware Version 6.7 or Later	30
Appendix E - Troubleshooting Guide	33
Appendix F - Replacing the Driven Element Bracket	39
SteppIR Warranty	41

40m - 30m Dipole Kit (RETROFIT 3E)			<h2>PARTS LIST</h2>
ITEM	QTY	PART #	DESCRIPTION
	1	72-0009-02	40M - 30M DIPOLE KIT
			DRIVEN ELEMENT KIT
BOX 1	1	72-0027-01	ELEMENT HOUSING UNIT (DRIVEN)
	1	72-0009-03	PVC GLUE PACK
	2	72-0027-02	SWEEP ASSEMBLY (RETURN LOOP)
	2	72-xxxx-01	COUNTER-WEIGHT BAR 2-1/2" x 12" x 1/2" (4 Element Retrofit Only)
			ELEMENT RETURN TUBE KIT
	1	72-0027-03	FIBERGLASS TUBE, 1.75" OD x 12"
	1	10-1505-01	ELEMENT RETURN BRACKET
BOX 2	4	70-2025-02	3/4" CPVC LINER TUBE WITH COUPLING (2-43.5" & 2- 49" LONG)
	4	72-0023-06	FIBERGLASS TELESCOPING POLE (FTP), 18 FOOT
			HARDWARE
BAG 1	16	60-0014-01	6-32 X 7/8 PANHEAD SCREWS
	16	60-0014	6/32 NYLOK NUT
	4	60-0014	4-40 X 3/4 PANHEAD SCREW
	8	60-0021-01	4-40 X 5/8 PANHEAD SCREW
	12	60-0022	4-40 NYLOK NUT
	2	60-0003	1-3/4 U-BOLT W/SADDLES
	2	60-0093	5/16 X 2-3/4 BOLTS
	6	60-0046	5/16 NYLOK NUTS
	7	60-0019	10-32 NYLOK NUTS
	2	60-0091	1/4-20 X 3-3/4 BOLT (4 Element Retrofit Only)
	2	60-0030	1/4 NYLOK NUT (4 Element Retrofit Only)
	8	60-0041	1/4 FLAT WASHER (4 Element Retrofit Only)
BAG 2	4	60-1006-01	QUICK DISCONNECT (RUBBER BOOT) 1.5" TO 1.25" - W/CLAMPS
	1	09-0002	CW 85 ELECTRICAL TAPE (66 ft)
	1	20-4003-01	CPU CHIP W/LATEST FIRMWARE & 40 - 30 BUTTON LABEL

Remove Existing Driven Element: (For Retrofit Installation ONLY)

- Retract all elements:
 - Using the controller:
 - Go to “Setup” mode and press ‘Select’
 - Using the ‘Up’ - ‘Dn’ buttons find “Retract Elements” and press ‘Select’
 - Using the ‘Up’ - ‘Dn’ buttons find “Yes” and press ‘Select’
 - Wait for the “ * ” to stop flashing
 - The elements are now retracted
- Disconnect the coax and control cable for the driven element
- Loosen the clamps holding the two rubber boots securing the fiberglass poles
- Remove the two fiberglass telescoping poles (FTP’s) from the driven element housing (Drawing 1 - 3 or 5)
- Remove the driven element housing (EHU) unit from its mounting plate (Drawing 1 - 3 or 5)

Note: For customers who purchased a 3 element antenna **before March 2003** your element housing brackets may have been of a different design. If you have the original style element housing bracket (approximately 4-1/4” across the top) you will need to install a new style element housing bracket on your boom before you can mount the new 40m - 30m dipole driven element housing unit (see **Appendix F**).

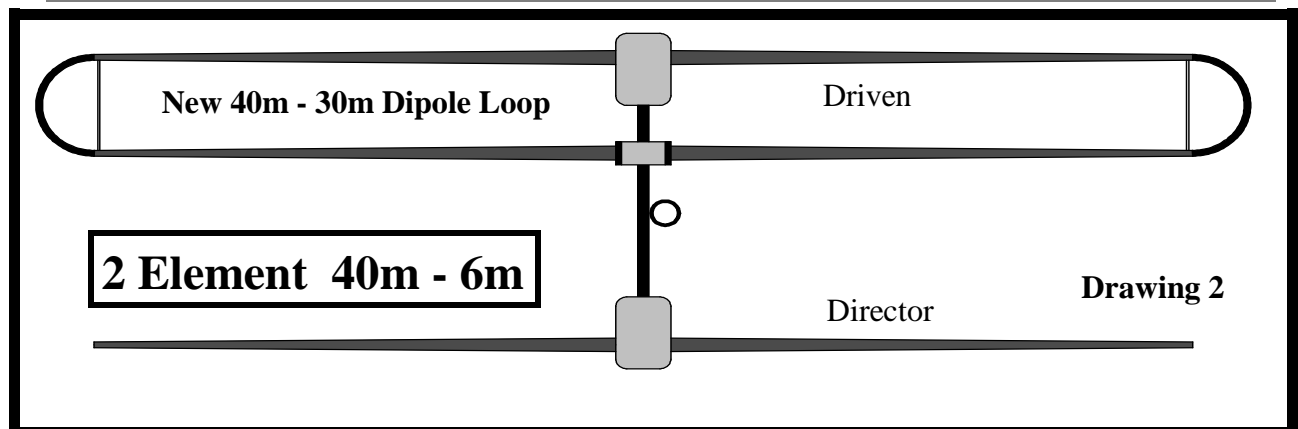
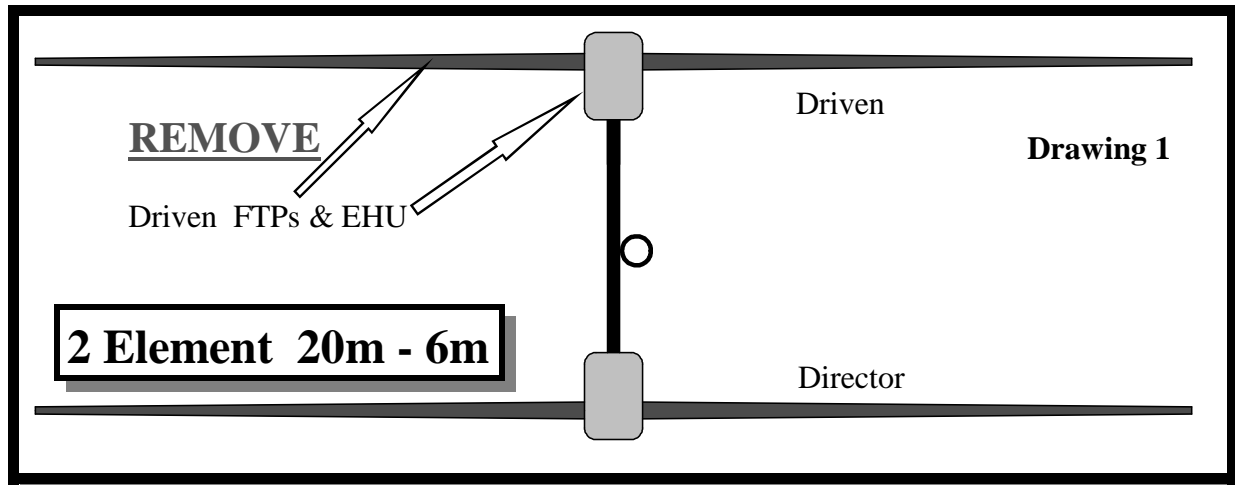

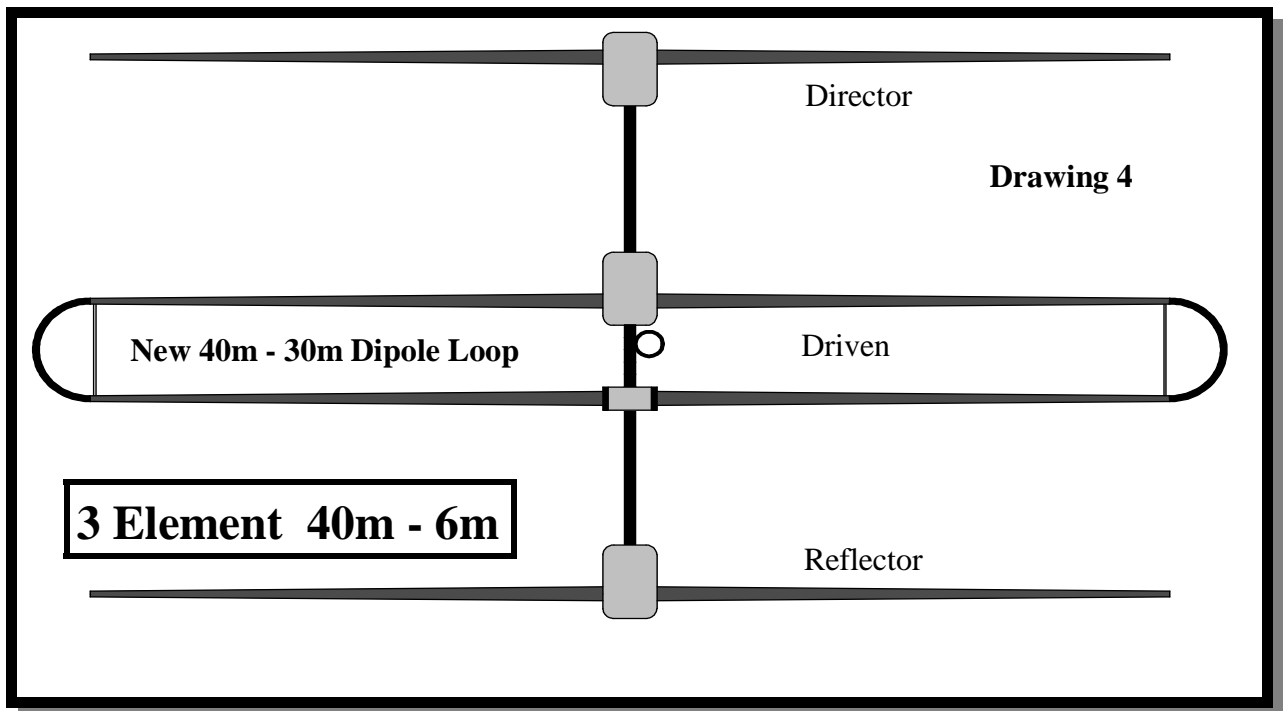
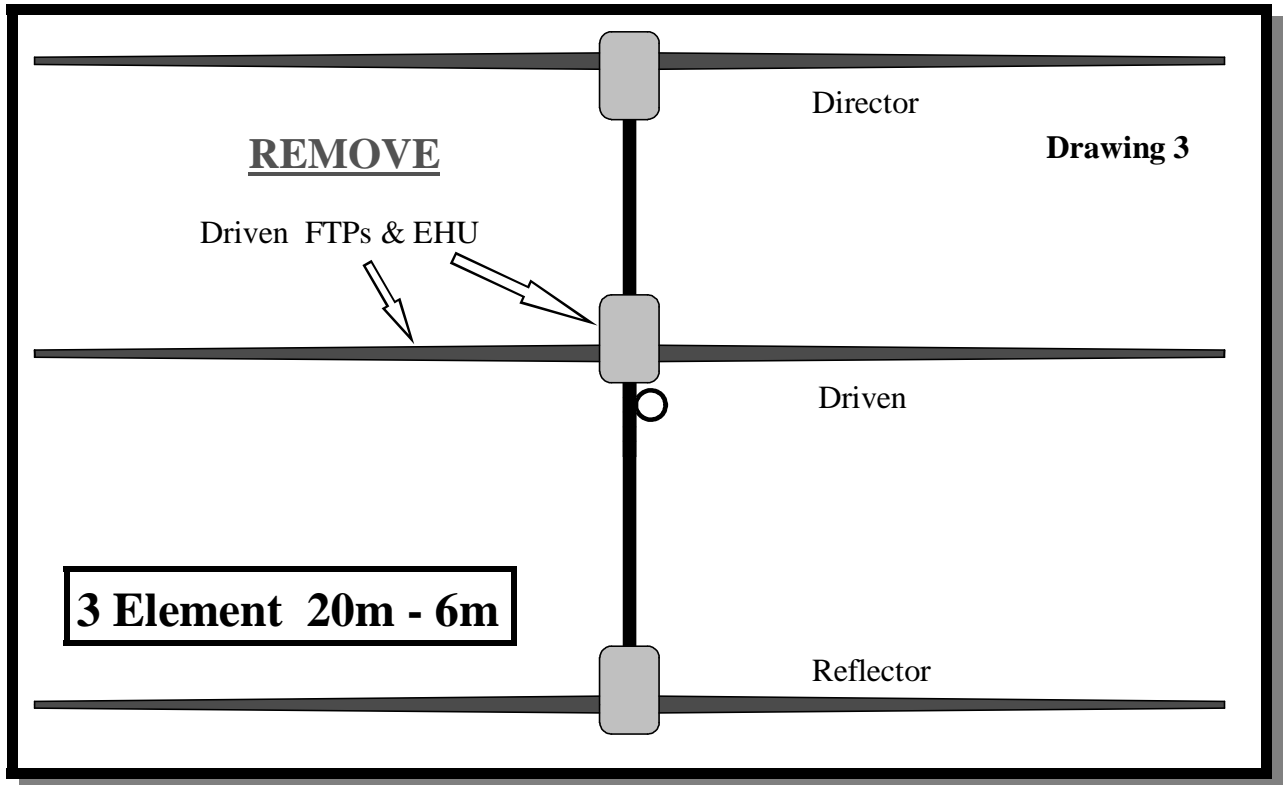

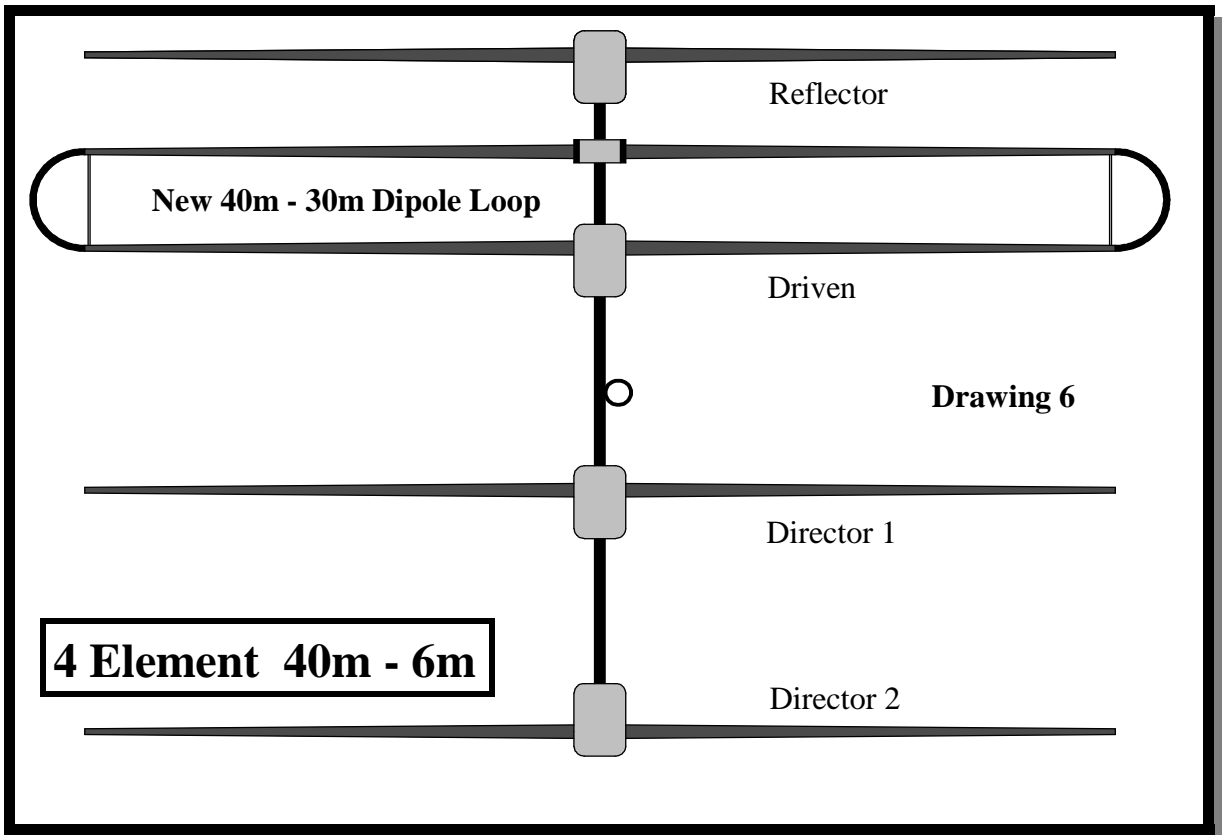
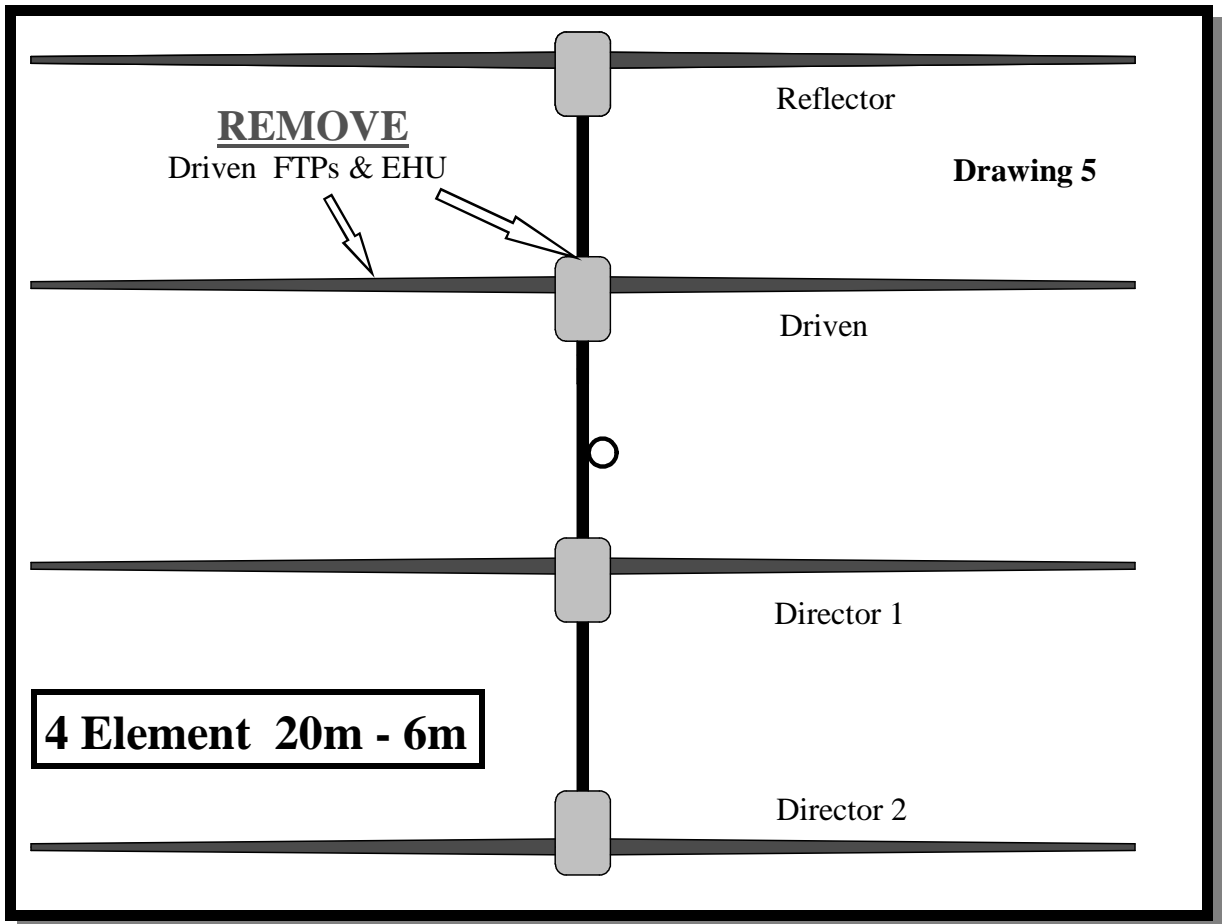

Install 40m - 30m Return Loop:

Install the Element Return Mounting Bracket: (For Retrofit Kit ONLY)

Note: The element return bracket comes installed when ordered with a new antenna.

- **Drilling instructions**

- Measure & mark the boom to install the return bracket per **Drawing 7, 8 or 9.**
- Secure the return bracket firmly in place with some type of clamp (**Picture 1**).
- Make sure to level the bracket with respect to the driven element bracket using either a level or actually mounting the element and eyeballing it.
- Drill four 5/16" holes, two in from each side, through the bracket and the boom using the pre-drilled pilot holes in the bracket as a guide (**Picture 1**).

Warning: Make sure that the bracket does not slip or twist while drilling. Keep the drill straight while drilling to produce a clean round hole. It may be helpful to drill both holes for one bolt and then install that bolt providing more positive alignment for the second hole.

- Install the two 5/16" bolts with Nylok nuts & tighten. These bolts should fit as snug as possible in the holes.

Note: For the **2 element boom only** you will need to move the mast plate from its original position in the center of the boom to make room for the return bracket. It can be located in any of the four (4) positions indicated in **Drawing 7**. It only needs to be moved enough to clear the return bracket. **If you will be installing the optional 6m passive element - only positions #2 or #3 can be used.**

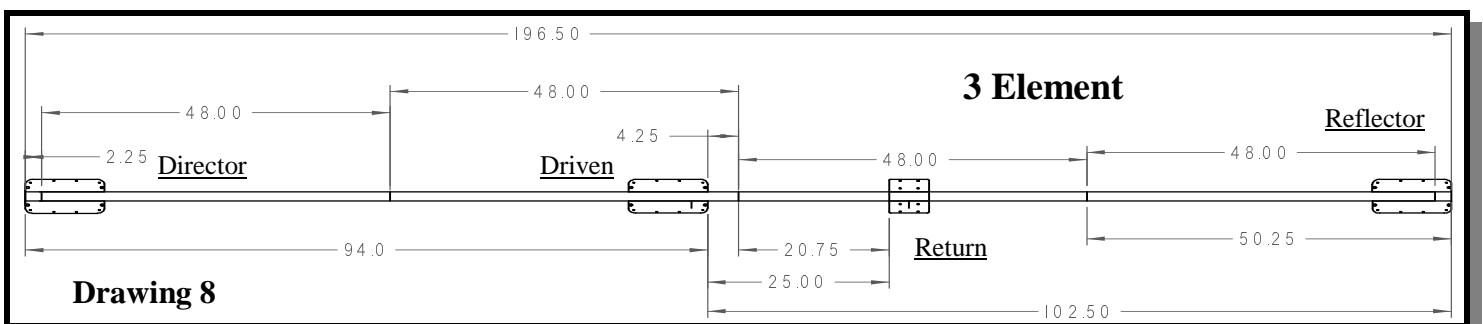
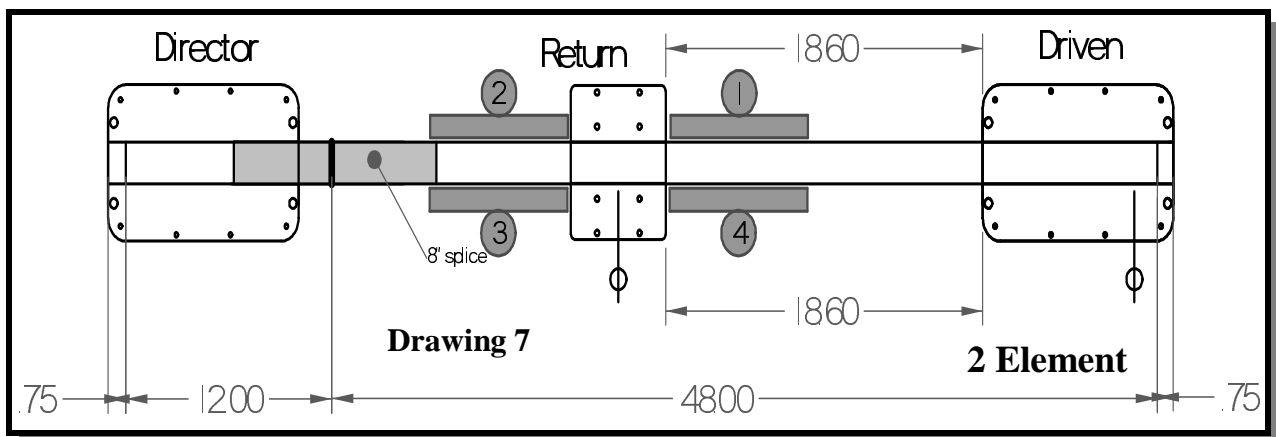

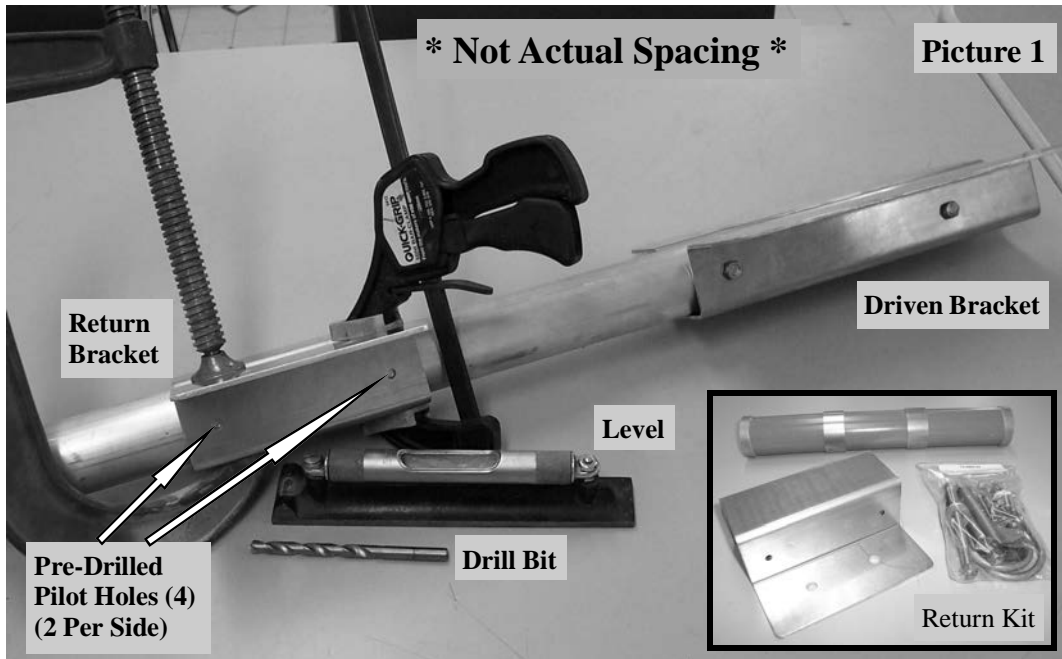
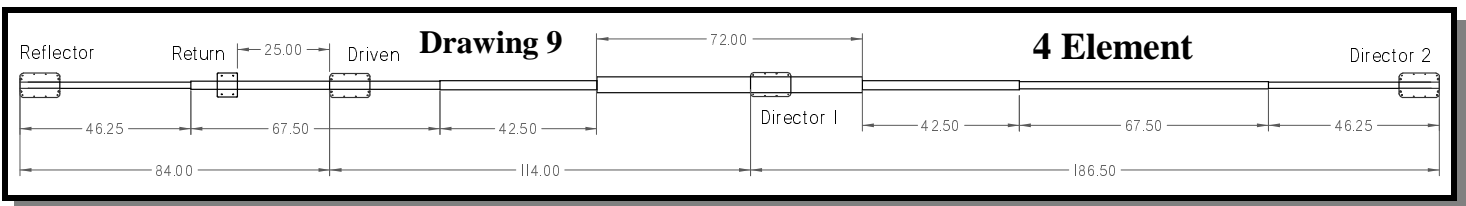

- **Assemble the Return Mounting Kit**

- Install return element cross tube and U-bolts as seen in **Picture 3** (center an aluminum sleeve under each U-bolt but do not tighten yet).

Note: Some of the U-bolt saddles have come from the supplier with the ears bent outward (**Picture 2-A**). It is recommended that you bend them straight so that they center on the reinforcing ring more securely and safer (**Picture 2-B**). The saddles will need to be pressed on securely (or tapped on with a hammer) until they bottom out.

- Measure the return tube offset to match the offset of the driven element housing tube (**Drawing 10**).
 - Tighten the U-bolts securely.

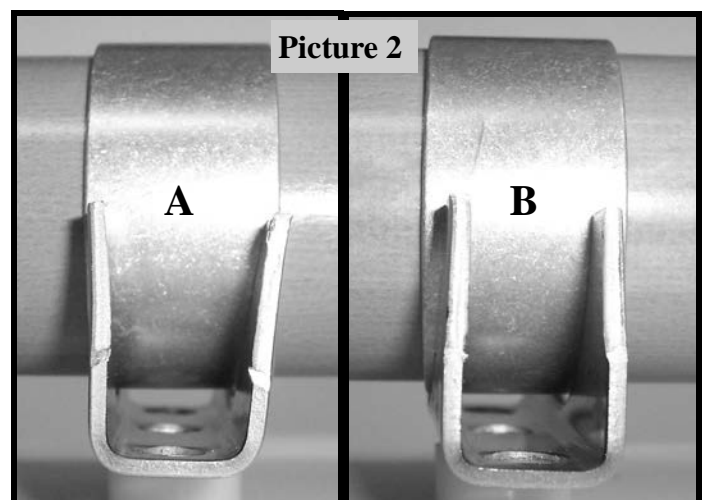

Picture 3

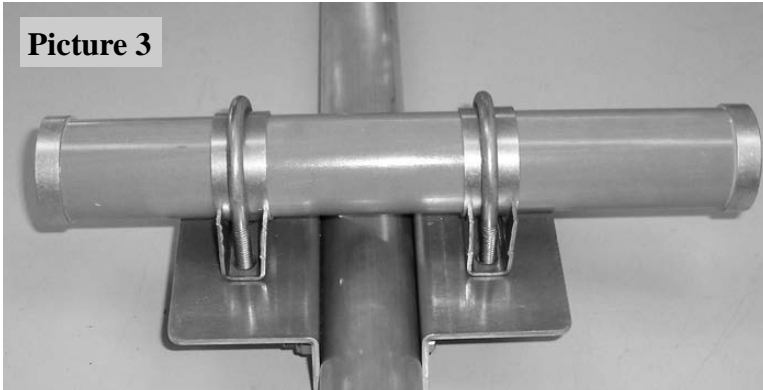

Drawing 10

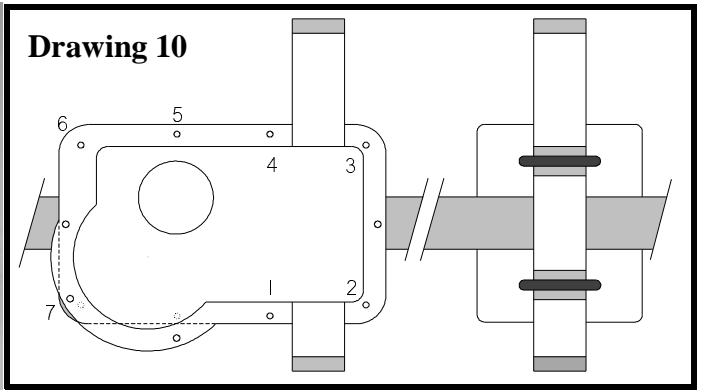

Install Boom Counter-weights (4 Element ONLY):

On the 4 element antenna ONLY you will need to install a pair of counter-weights to the side of the **Director 2** element mounting bracket (**Picture 3B**) to balance the boom after the installation of the 40m - 30m dipole kit. These are powder coated steel bars weighing approximately a total of 8.2 pounds.

Locate: (**Picture 3A**)

- Two steel bars 2-1/2" x 12" x 1/2" (counter-weights)
- Two 1/4-20 x 3-3/4" bolts
- Two 1/4-20 Nylok nuts
- Eight 1/4" flat washers

Suggested Installation Steps (retrofit only):

- On a retrofit installation you should not need to remove the element housing unit (EHU) from the element mounting bracket but do be careful with the weight of the EHU and the FTP's attached when you remove the existing bolts.
- Remove the first 1/4" bolt from the **Director 2** element mounting bracket and install it back into its hole from the other side of the bracket. This will support the bracket while you remove the second bolt.
- Remove the second 1/4" bolts from the **Director 2** element mounting bracket.
- Put two 1/4" flat washers on each of the new 1/4-20 x 3-3/4" bolts.
- Position the first counter-weight by lining up the holes so that the end of the weight is even with the end of the element mounting bracket (**Picture 3B**) and install a new 1/4-20 x 3-3/4" bolts with the two flat washers through the empty hole.
- Now install the second new 1/4-20 x 3-3/4" bolts with the two flat washers through the second hole pushing out the old bolt that you temporarily installed from the other side.
- Put the second counter-weight over the two new bolts sticking out.
- Install two flat washers on each bolt and then the new Nylok nuts and tighten.
- The end results should look like **Picture 3B**.
- This completes the installation of the counter-weights.

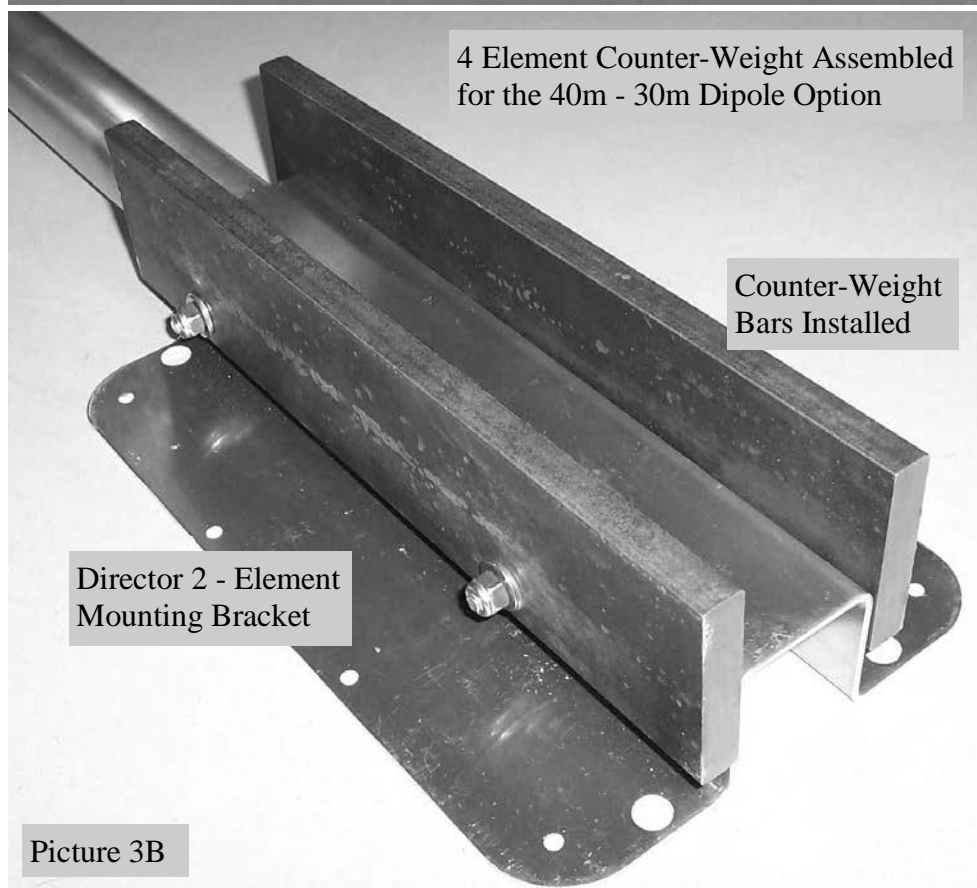
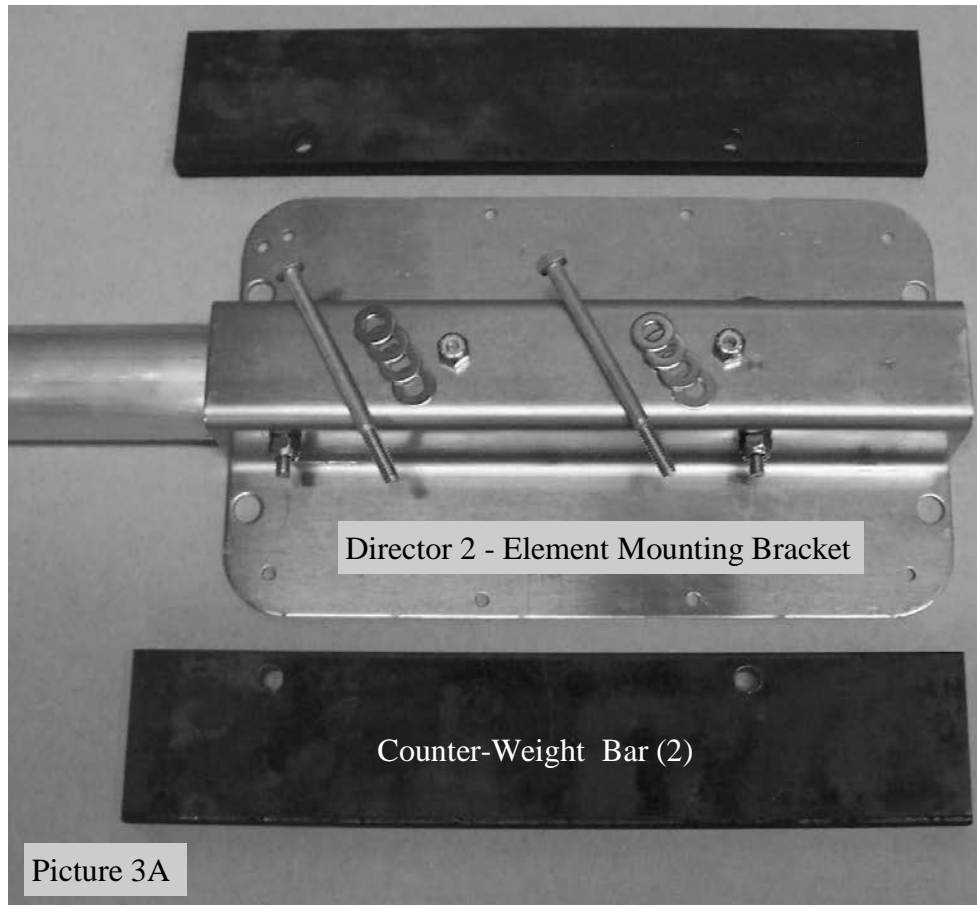

Install the Element Housing Unit (EHU):

Warning: (For a retrofit installation only) Mount the new 40m - 30m driven element housing unit (EHU) in the **SAME** orientation as the old unit that you removed. Also refer to **Drawing 2 - 4 or 6**.

- Install the driven element housing unit onto the element bracket with bolts in holes 1 through 7 (**Drawing 10**) and tighten. Use the seven (7) new 10-32 Nylok nuts and the existing screws. (For a retrofit installation only) hole # 7 will need to be drilled through the aluminum element bracket (with a # 6 or a 13/64" bit) before the bolt can be installed and tightened.
- If the mounting holes in the new EHU do not line up with the holes in the element mounting bracket you may need to loosen the two horizontal bolts [**Picture 1 (Driven Bracket)**] that secure the element mounting bracket to the boom and then insert the screws in the EHU and tighten. Be sure to retighten the two horizontal bolts when you are finished mounting the EHU.
- The remaining three bolts do not pass through the aluminum element plate but be sure they are tight also.

Note: With a retrofit installation this is the point where you want to reconnect the control cable and run the "Test Motors" procedure outlined in the main antenna installation manual to verify the wiring is correct and everything is functioning before final assembly.

Installing CPVC Liner Tubes:

Locate:

- Four pieces of 3/4" CPVC liner extension tubing (**picture 4 & 5** only has 2 shown in picture) with CPVC coupling installed, two poles for each side.
- One CPVC glue kit
- One or more good assistants
- Using the supplied glue and cotton tips, apply the glue onto any area where there is a CPVC connection. Be sure and place the glue onto the outside of the CPVC tubing and **NOT ON THE INSIDE OF THE COUPLER**. Then slide the coupler onto the CPVC so that none of the glue goes onto the inside of the CPVC, this would cause a potential blockage inside the tube.
- Glue the two CPVC sections together so that the 43.5" section can be glued to the element housing and the 49" will slide into the Fiberglass Telescoping Pole first. Let it dry for ten minutes.
- Repeat this process for the other side.

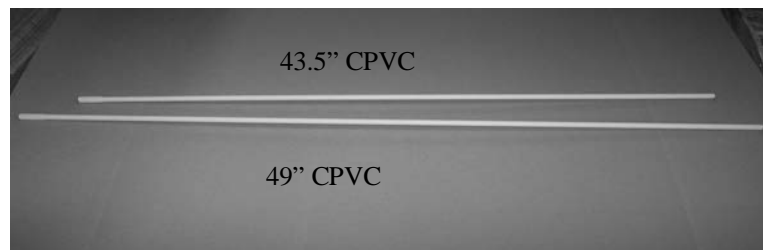

Note: You may need to prop up the CPVC until the glue sets.

Warning: This will leave you with the two liner extensions sticking out. Be very careful not to hit or catch anything on these liners as this could damage the CPVC. These liners will be covered with the installation of the Fiberglass Telescoping Poles in the next operation. Be equally careful when sliding them into place.

- Prepare the special EST's marked 30 - 40 as described in the “**Prepare the Fiberglass Telescoping Poles (FTP)**” section and “**Assemble the Sweeps to the Poles:**” sections.
- Read the “**Attach the 40 - 30 FTP's to the EST & ERT**” section before continuing.
- Slide the entire CPVC extension into the Fiberglass Telescoping Pole, except for 6” to allow for gluing to the CPVC in the element housing, as shown in **Drawing 11**.

Note: It may take a number of attempts to get the CPVC liner tube to go past the second section of the Fiberglass Telescoping Pole, allowing it to go in all the way (**Drawing 11**). Gently shaking the CPVC can be helpful. Take your time and be careful with it.

- Then you will glue the CPVC extension tube to the internal CPVC of the driven housing (**Picture 6**)

Fiberglass Telescoping Pole with Internal CPVC for 40/30m Diagram

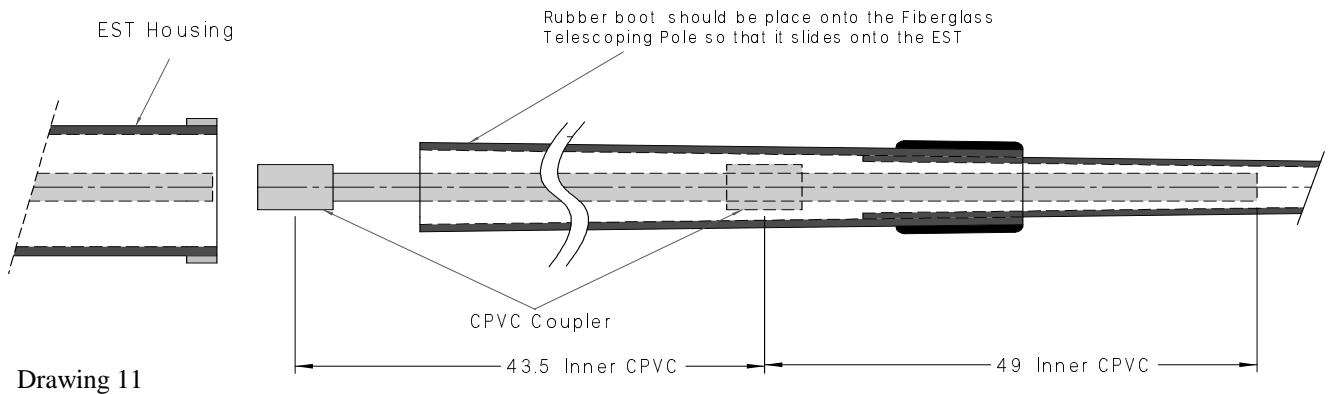

Drawing 11

- After the glue has been dried, then finish the assembly as described in the “**Attach the 40 - 30 FTP's to the EST & ERT**” section.
- Repeat these instructions for the other side to finish the installation of the 40m - 30m loop assembly.

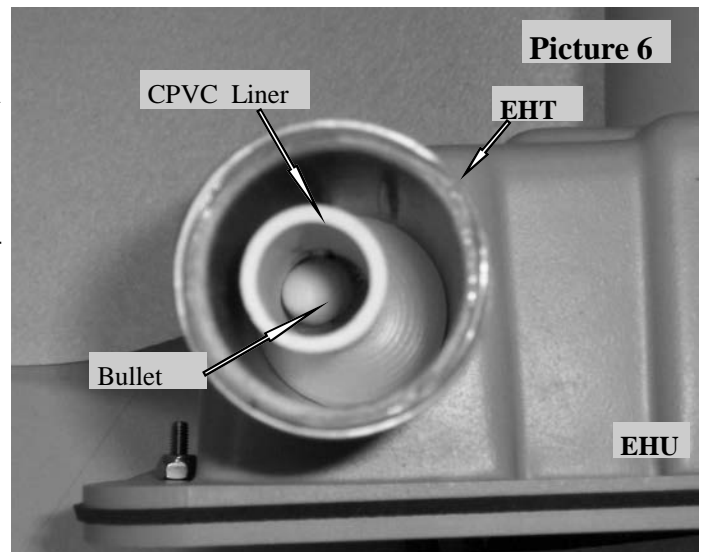

Prepare the Fiberglass Telescoping Poles**Locate:**

- Four dark green fiberglass telescoping poles (**Picture 13**)
- Four quick disconnect boots with clamps (**Picture 5**)
- One roll of black vinyl electrical tape (**Picture 11**)
- Your tape measure

Note: The steel reinforcing rings on the first two pole sections provide extra strength in potential high stress conditions.



Picture 5

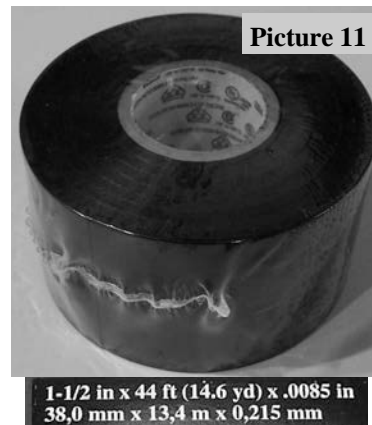

Picture 11

1-1/2 in x 44 ft (14.6 yd) x .0085 in
38,0 mm x 13,4 m x 0,215 mm

The green fiberglass telescoping poles are all assembled in the same manner and, when extended, keep the copper-beryllium tape safe from the weather. The copper-beryllium tape is shipped retracted inside their respective element housing units (EHUs).

Repeat the following procedure for each telescoping pole

Telescope a pole to full length by jerking each section out very **aggressively** with a twisting motion until it is extended as far as possible. **Each segment is tapered and should lock (jam) securely in place when fully extended.** It is especially important on the 40 - 30 driven element that the poles are very firmly telescoped. You don't want them potentially twisting out of level in the wind - that would not look good. Each pole's length, when fully extended, must be 17' 8" +/- 1" in length as measured from the butt (large) end of the pole to the tip. (**Picture 13**)

Caution: Verify the length for each pole before proceeding.

If a pole comes up a little short try collapsing the pole and starting over, this time aggressively "jerk" each section out instead of twisting. The pole cannot be damaged and you may gain a minimum of 1/2" or more.



Picture 13

17'8" +/- 1"

If you have trouble collapsing a pole try carefully striking one end on a piece of wood or other similar surface placed on the ground. If necessary you can use a hard plastic faced mallet to drive the sections in.

At the factory when we quality check the poles to verify that they meet minimum length we hold the butt (large) end and whip it like we were casting a fishing pole with considerable force. This procedure can produce a significant difference in the extended length of some poles as a last resort if nothing else works.

DO BE CAREFUL !!!

Warning: Check all four sections of each pole for packing popcorn or any other foreign object that could interfere with the copper tape movement.

There are **NO** foam plugs glued in the small end of these four special dark green telescoping poles as there are in a regular pole. This is the correct configuration for the four 40 - 30 poles.

Next wrap each joint on the fiberglass poles (**Picture 15**) with the vinyl electrical tape (**Picture 11**). Use approximately: **40 in. On the first (large) joint**
31 in. On the second (middle) joint
22 in. On the third (small) joint.

For each joint, stretch the tape tight (up to 50 %) as you wrap it. This should make at least two passes. **This new tape replaces the old electrical tape and silicone tape process we used before.** Each joint should have at least the full width of the tape on both sides of the joint.

Exception: On joints with reinforcing rings, the tape must continue further so it extends a minimum of one full tape width beyond the metal ring and onto the fiberglass pole.



Start the tape with one complete wrap of electrical tape around the fiberglass telescoping pole. The tape should be applied in half-lapped layers with sufficient tension to produce a uniform wind (for most applications this tension will reduce the tape's width to approximately 5/8 of its original width). In the beginning wrap the tape up-hill, taping from a smaller diameter surface to a larger diameter surface then back down smoothing the tape with your fingers as you go. Apply the tape with no tension on the last full wrap to prevent flagging. At the end of the run, cut the tape with a knife or scissors and press it down flat. Then run your hand over the tape again a couple of times to smooth it and firm up the bond-

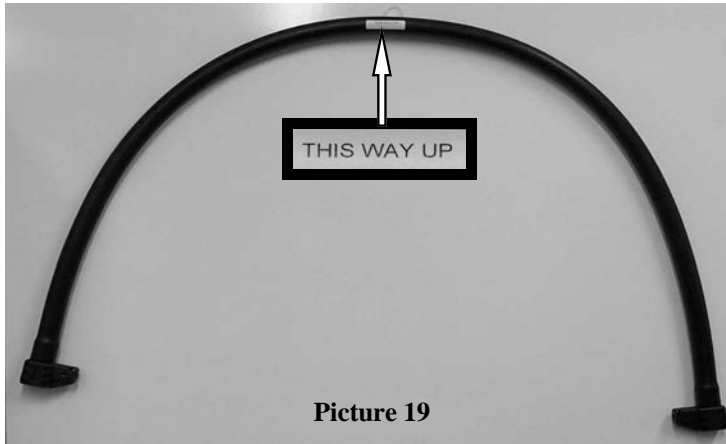

Picture 19



Picture 21

Assemble the Sweeps to the Poles:

- Locate:
- 2 Sweep Assemblies (Picture 19)
 - 2 3/8 x 28" White Fiberglass Rods
 - 4 #4 x 3/4" Screws w/Nylok nuts
 - 8 #4 x 5/8" Screws w/Nylok nuts
 - 16 #6 x 7/8" Screws w/Nylok nuts
 - 4 Telescoping Fiberglass Poles
 - 1 Small container of silicone grease (Picture 25.5)

Layout two poles (fully extended and taped) parallel about 30" apart. The tip of each pole will have an "O" ring seal (glued on) and a piece of adhesive non-skid attached to it (Picture 21). Their will also be one extra strip (spare) of non-skid tape in the hardware kit in case a repair is needed. This material is to provide a very secure grip for the return loop fitting to grab on to.

Get one of the sweep assemblies, making sure the label [THIS WAY UP] is on top (Picture 19) and the drain holes in the tip of the loop are to the bottom. Insert one of the pole tips into each of the sweep fittings (Picture 25) making sure that they go in until they bottom out (approximately 2-3/8"). The non-skid tape should go completely inside the fitting (Picture 27). It may be a good idea to mark the poles so you can see when they are fully seated.

WARNING: Petroleum base lubricants WILL damage the polycarbonate fittings (Picture 25). We recommend that you apply a thin film of the NON PETROLEUM based silicone grease - (provided - Picture 25.5) to the "O" ring as it is inserted in the fitting.

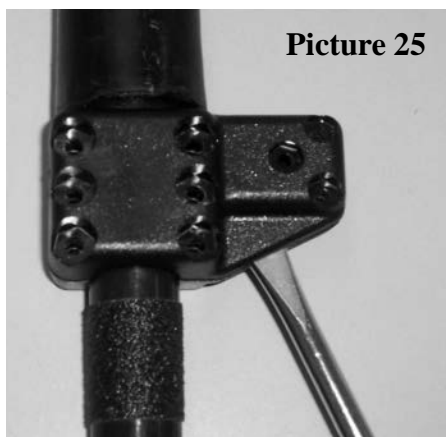

Picture 25



Picture 25.5

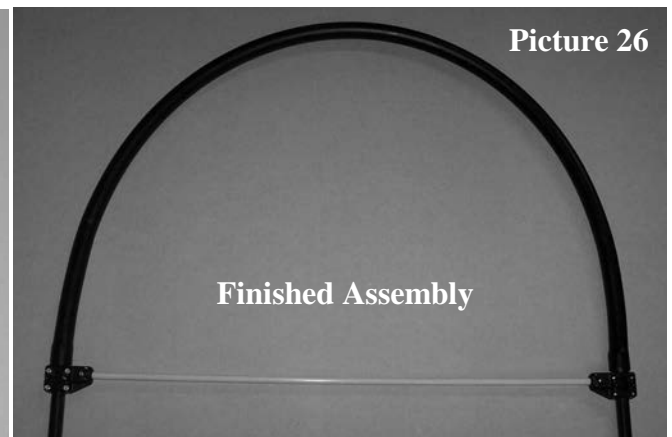

Picture 26

Finished Assembly

Caution: Inserting the pole tip into the sweep fitting may be very tight. You may need to insert a screwdriver into the gap on the edge of the fitting (**Picture 25**) and pry it apart enough to push the pole home. Be careful not to damage the “O” ring seal or the non-skid tape when inserting the poles.

Now insert one of the white fiberglass rods, one end into each fitting (**Picture 26 & 29**), into the assembly and line up the holes.

Repeat this procedure for the other side.

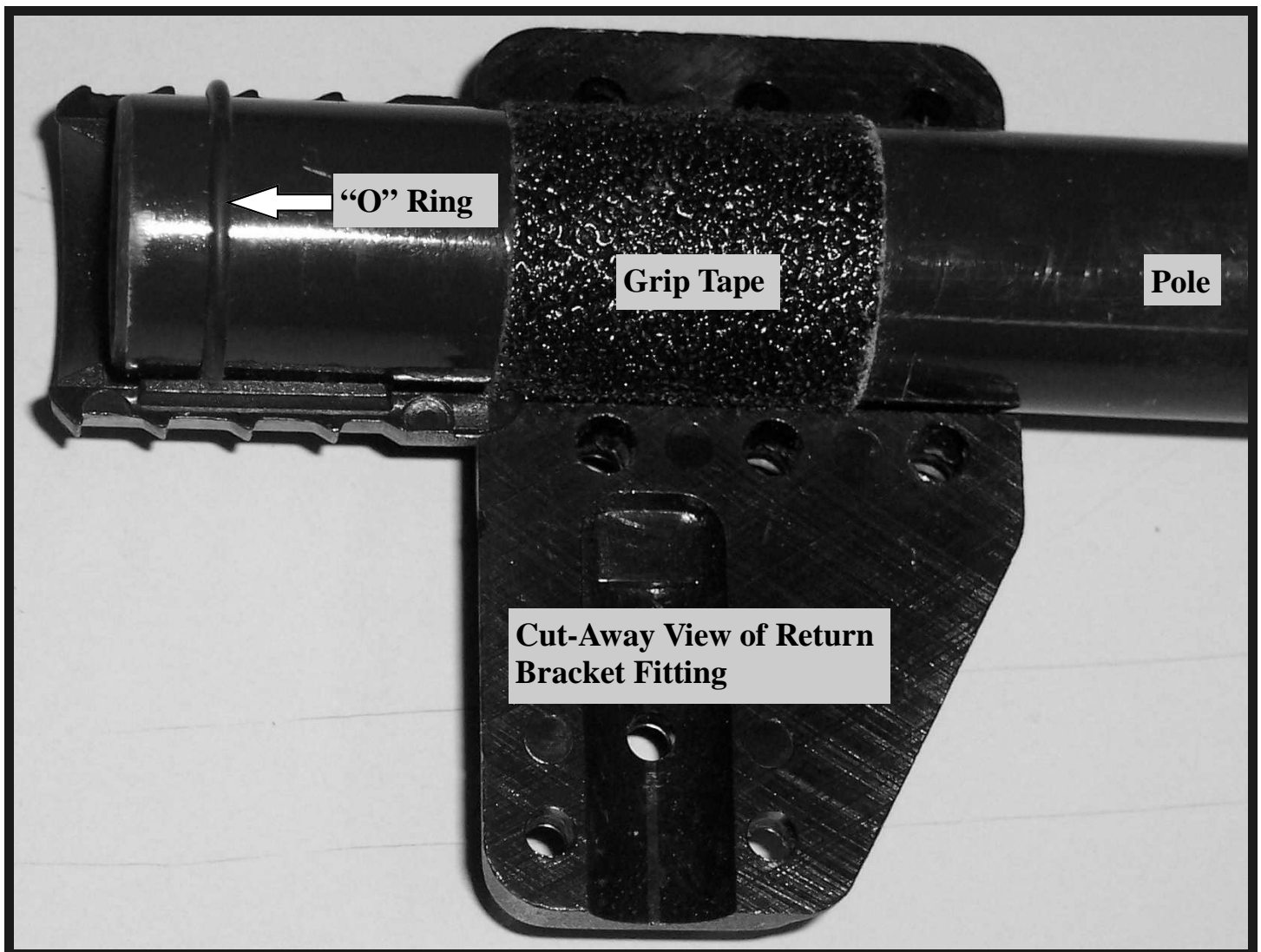

Picture 27 is a cut-away to show the position of the pole tip and its components as they fit together inside the sweep fitting.

Now, as seen in **Picture 29**, insert the four #6 screws and Nylok nuts in each of the fittings and tighten to secure the fitting to the green poles. Be sure to place the nut into the side of the fitting that is molded to capture the nut (**Picture 28**), **Do not tighten yet**.

Next insert the #4 screws and Nylok nuts used to properly secure the 3/8" white fiberglass rod that stiffens the return loop assembly. The center screw is #4 x 3/4 and the other two screws are #4 x 5/8 (**Picture 29**). When inserting the middle screw through the fiberglass rod you may need to screw it in with a screw driver to get it to go through. Again observe the correct side of the fitting to place the nuts. Now tighten all the screws.

Note: You may need to hold the nut down in the pocket with your finger when you first begin tightening each screw.

When both return loop assemblies are properly mounted to the ends of the fiberglass telescoping poles the two resultant assemblies are ready for final preparation and installation to the element housing tube and the return bracket tube (**Drawing 13**).

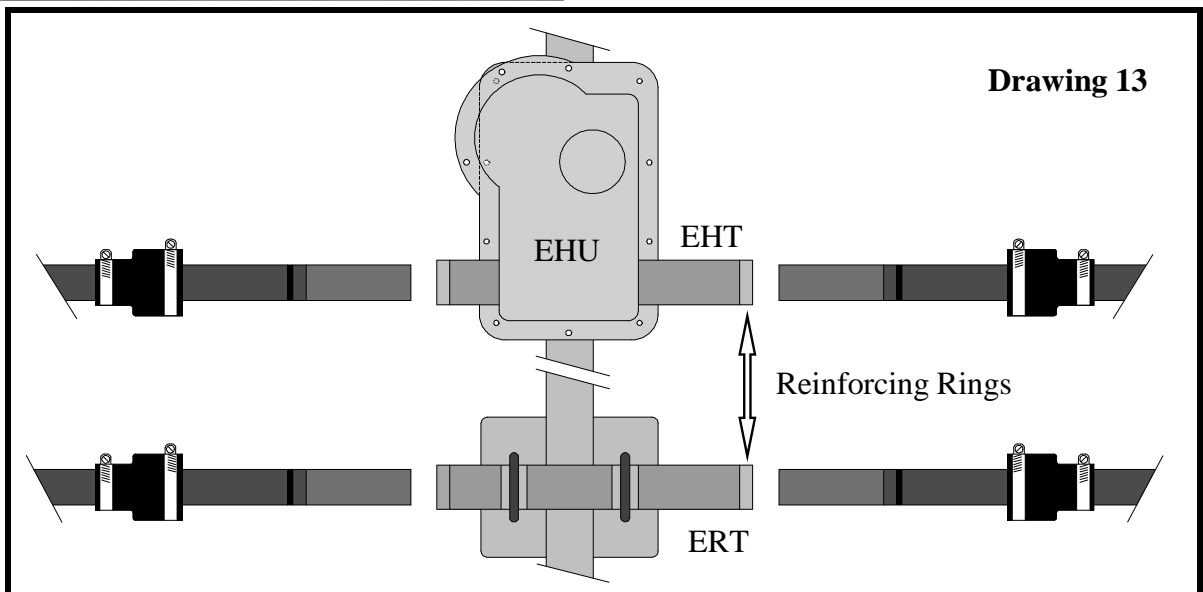
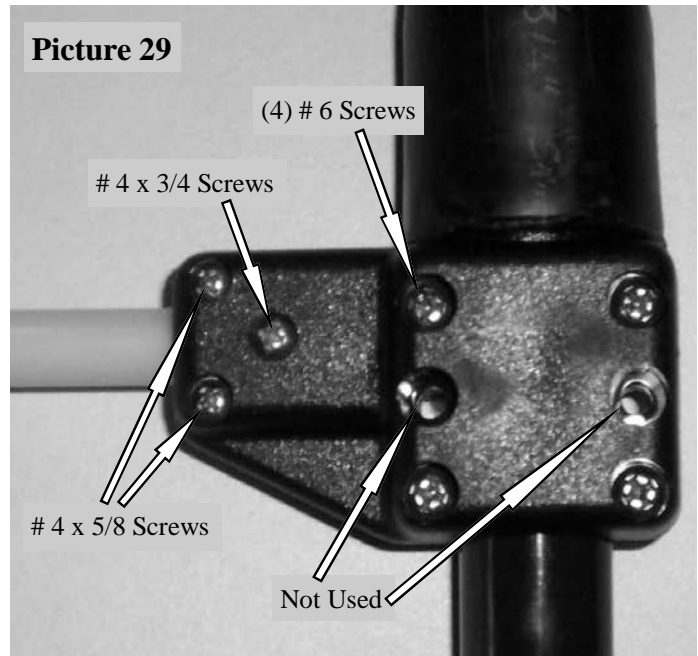
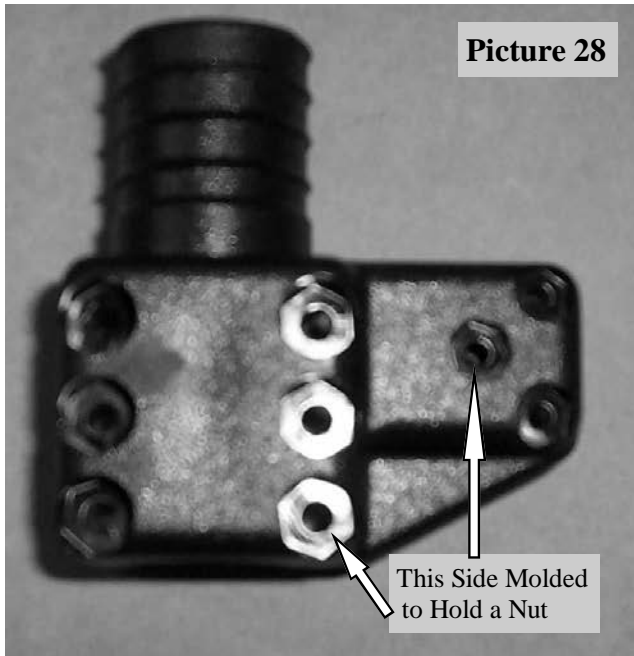

Attach the 40 - 30 FTPs to the EST & ERT:

The butt (large) ends of the green fiberglass telescoping poles (FTP's) may vary slightly in outside diameter. Some of them may have been sanded, while others were not. The colors at the ends will be either natural, or black. The difference in colors has no affect on performance. Do not be concerned if they vary slightly in tightness when being installed in the EST's. This is normal. All poles are tested at the factory prior to shipping, however in the event that a specific pole just won't fit sanding it is okay.

The EST's on the EHU's have aluminum reinforcing rings (**Drawing 13**) attached to provide extra strength in high wind conditions.

Locate the four quick disconnect boots (rubber) and repeat the following procedure for each of the four fiberglass telescoping poles.

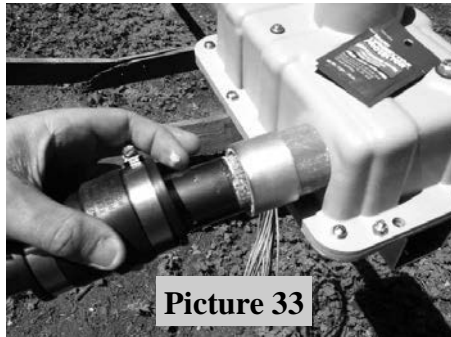
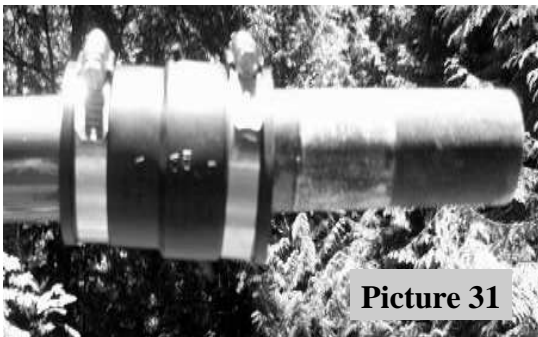

- Place the narrow end of a rubber boot onto the butt (large) end of each of the two poles of the first assembly and slide them about 6" up each pole (**Figure 31**).
- Insert the butt ends of each of the two pole assemblies into one side of the EST and the ERT (**Drawing 9**).

Caution: It is very important to ensure that the butt (large) end of each fiberglass telescoping pole firmly bottoms out (is seated) inside the driven element EST.

On the element return tube (ERT) the pole (FTP) may be adjusted in or out a small amount to get the tips of the two poles even (where the sweep is attached - **Picture 27**), just make sure the black raised ring on the FTP is covered by the rubber boot.

- Push each rubber boot firmly onto its EST until the hose clamp is past the aluminum ring and will clamp down onto the fiberglass telescoping pole (**Picture 35**). It is imperative that the stainless steel hose clamp be located so that the clamp on the outside of the rubber boot on the EHU side of the connection is completely PAST the aluminum reinforcing ring. This ensures that the hose clamp can grip onto the fiberglass and the ring will prevent the rubber boot from ever coming off.

Note: Before tightening the rubber boots ensure the 40m - 30m driven element loop tip is level by rotating the butts of each EST until the element tip is level.

- Firmly tighten both stainless steel hose clamps, one over the EST and the other over the FTP. Then test the connection by pulling and twisting it. There should be no slippage at the joints.

- Finally wrap each of the quick disconnect boots (rubber) between the clamps with two layers of the premium all weather electrical tape the same way as you wrap the joints on the FTP's (**Picture 15**). Remember to stretch the tape tight and smooth it down while wrapping. This tape will help protect the rubber from UV radiation.

After installing both return loop assemblies and double checking that all connections are made and fittings are properly tightened the assembly of the 40m - 30m dipole section is complete.

If this is a retrofit kit it is time to mount the antenna otherwise return to the main assembly manual.

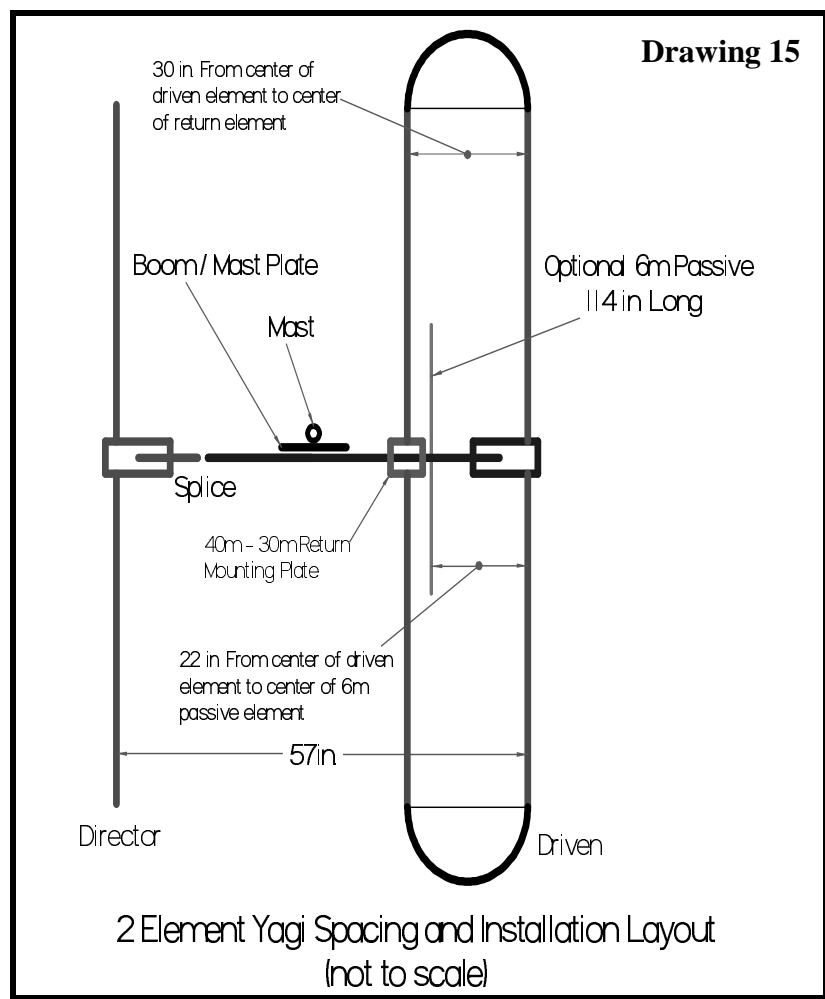
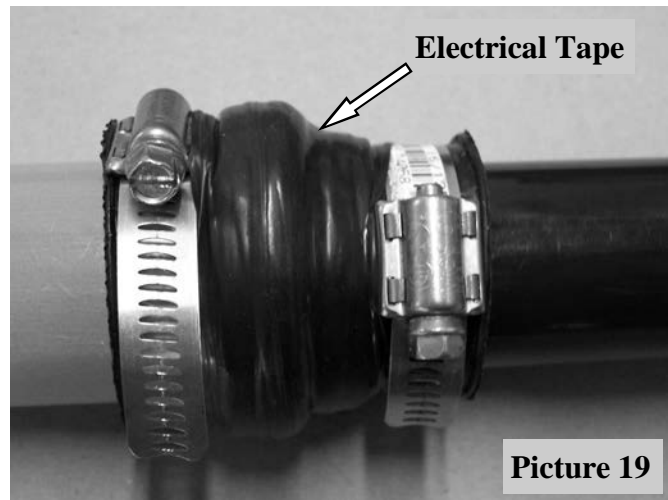

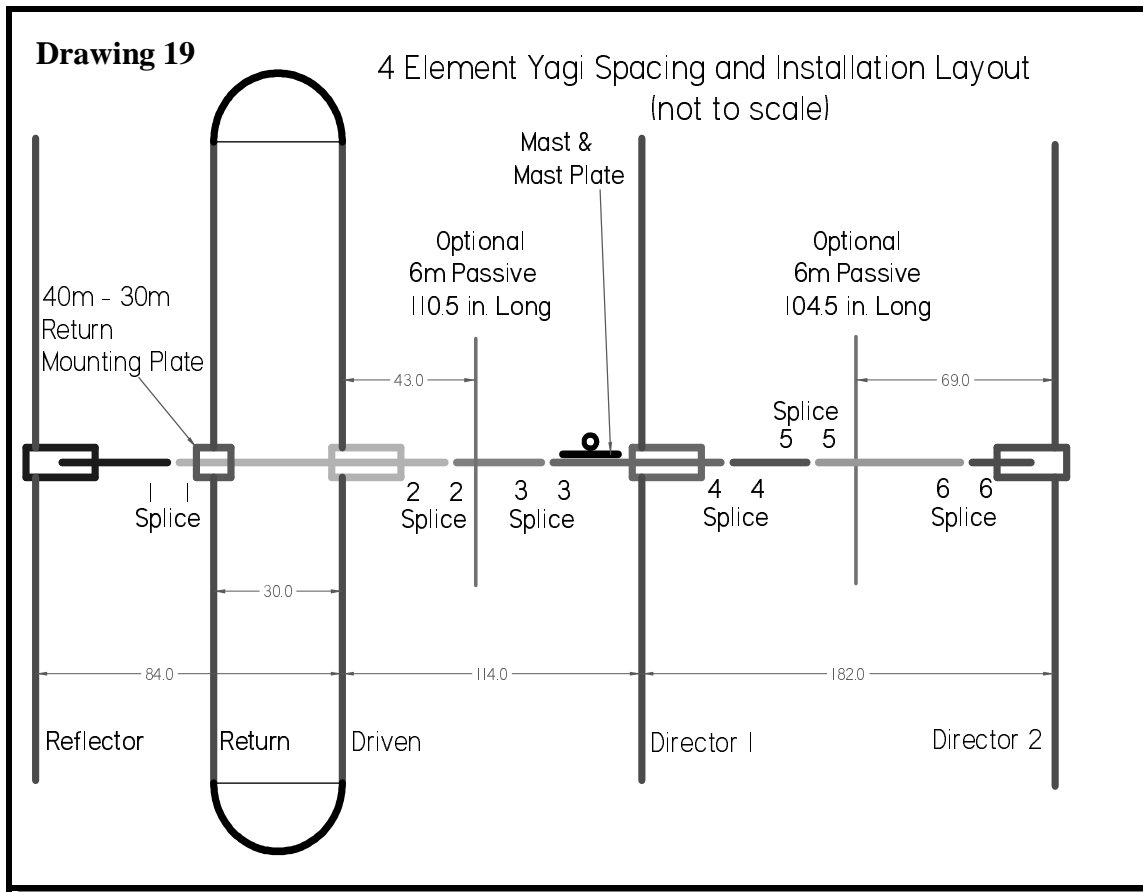
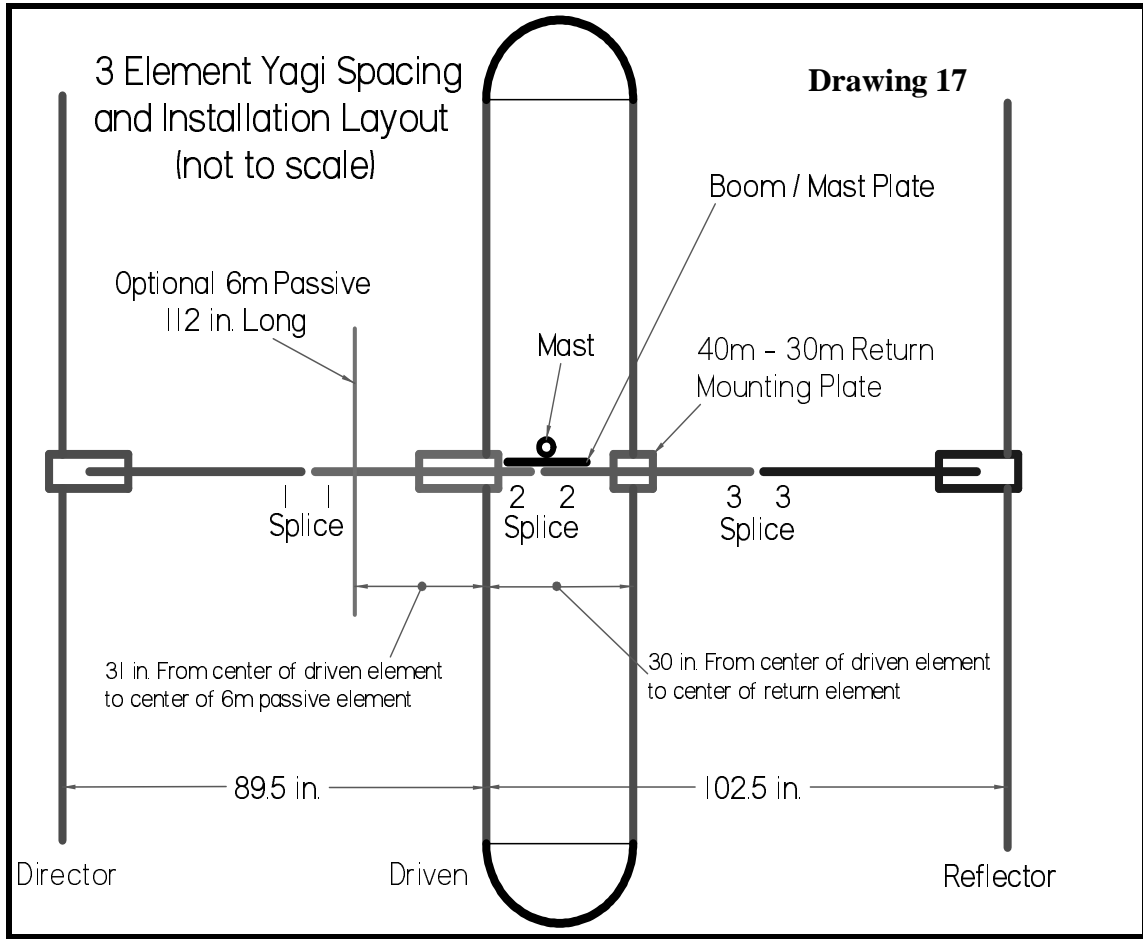

New Antenna Specifications With The 40m - 30m Dipole Installed

Specifications W / 40m - 30m	→	2 Element Yagi	3 Element Yagi	4 Element Yagi
Weight	→	37 lb / 16.8 kg	58 lb / 23.1 kg	108 lb / 49.0 kg
Max. Wind Surface Area	→	6.0 ft ² / .56m ²	8.1 ft ² / 0.75 m ²	11.7 ft ² / 1.09 m ²
Wind Rating	→	100 MPH EIA- 222-C	100 MPH EIA- 222-C	100 MPH EIA- 222-C
Longest Element	→	39 ft / 11.88 m	39 ft / 11.88 m	39 ft / 11.88 m
Power Rating	→	3000 Watts Key Down	3000 Watts Key Down	3000 Watts Key Down
Boom Length	→	57 in / 1.44 m	16 ft / 4.87 m	32 ft / 9.75 m
Boom Diameter	→	1.75 in 4.5 cm	1.75 in 4.5 cm	2.50 - 1.75 in 6.35 - 4.5 cm
Mast Diameter	→	2.0 in / 5.08 cm	2.0 in / 5.08 cm	2.0 in / 5.08 cm
Frequency Coverage	→	40m - 6m Continuous	40m - 6m Continuous	40m - 6m Continuous
Turning Radius	→	18.15 ft / 5.53 m	19.7 ft / 6 m	24.1 ft / 7.35 m
Cable Requirements	→	12 conductor 22 AWG (shielded)	12 conductor 22 AWG (shielded)	16 conductor 22 AWG (shielded)
Tuning Rate	→	1.33 ft/ sec .40 m/sec	1.33 ft/ sec .40 m/sec	1.33 ft/ sec .40 m/sec
Balun Included	→	Yes	Yes	Yes

Appendix A:

6 Meter Passive Installation (3 Element)

The use of the optional 6m passive element on 3 element antennas configured at the end of 2003 and later (**Drawings 17**) or earlier antennas modified to the new configuration do not present any problems working with the new 40m - 30m dipole kit.

Antennas configured earlier (**Drawings 21**) that have not been modified to the new configuration will need to be modified before the new 40m - 30m dipole kit can be installed.

With the early 3 element antennas the direction on 6m was 180 degrees different from the other bands (what were we thinking? - actually, you get very slightly better gain the other way, about .2 dB - not worth the confusion).

The six meter aluminum element now mounts between the driven element and the director (the elements that are approximately 89" apart). The center of the 6m element should be 31" from the center of the driven element. (**Drawings 17**)

This change also necessitated adding 2" to each side of the aluminum element, for a total of 112" from tip to tip. The beam still works very well and without the mental gymnastics of keeping track of your real direction on 6 meters!

The 6m element has enough 3/8 tubing inside to extend it to the new length of 112 inches. All you will have to do is drill new holes.

The controller is all ready to go with the new firmware. All you need to do is enable the option using the "Options" menu.

This should be all you need to swap the 6m element position to the Normal direction.

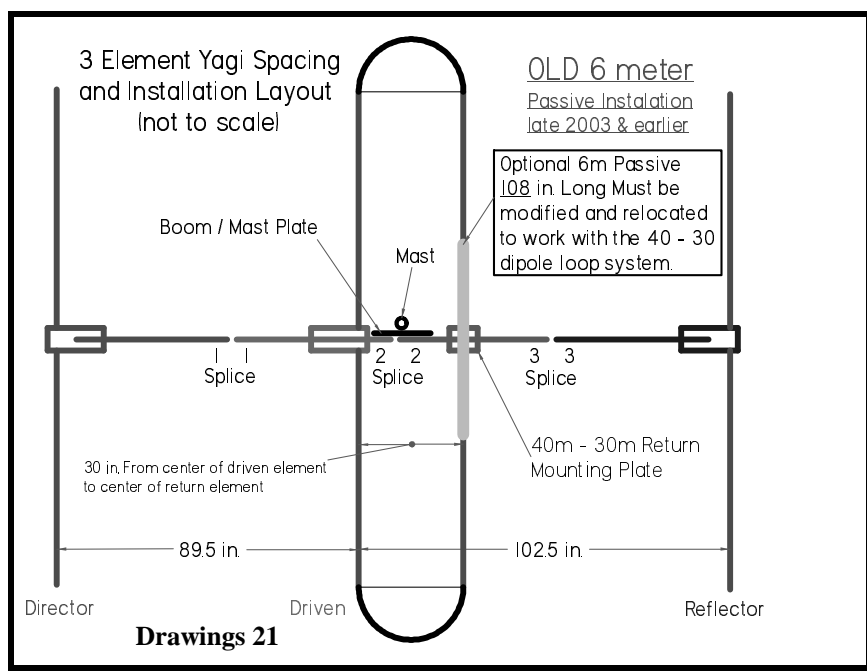

Appendix B:

Controller (Upgrade)

Unless your firmware is version 6.704 or later you will need to update your controller firmware with the provided chip. If you do not know what version of firmware you have on your controller the version number will appear in the upper right hand corner of the controller display (**Picture A**) when you first turn it on. If your controller does not have a 40m band button you will need to install the provided label to properly identify the band buttons for the new firmware. Look over the software options carefully, the frequency offset will need to be adjusted in most cases to center your antenna with the new firmware. Remember to enable the 40/30 option in the menu.

Instructions for controller firmware version 6704 or later will be in with your new chip, in the back of your antenna manual or both.

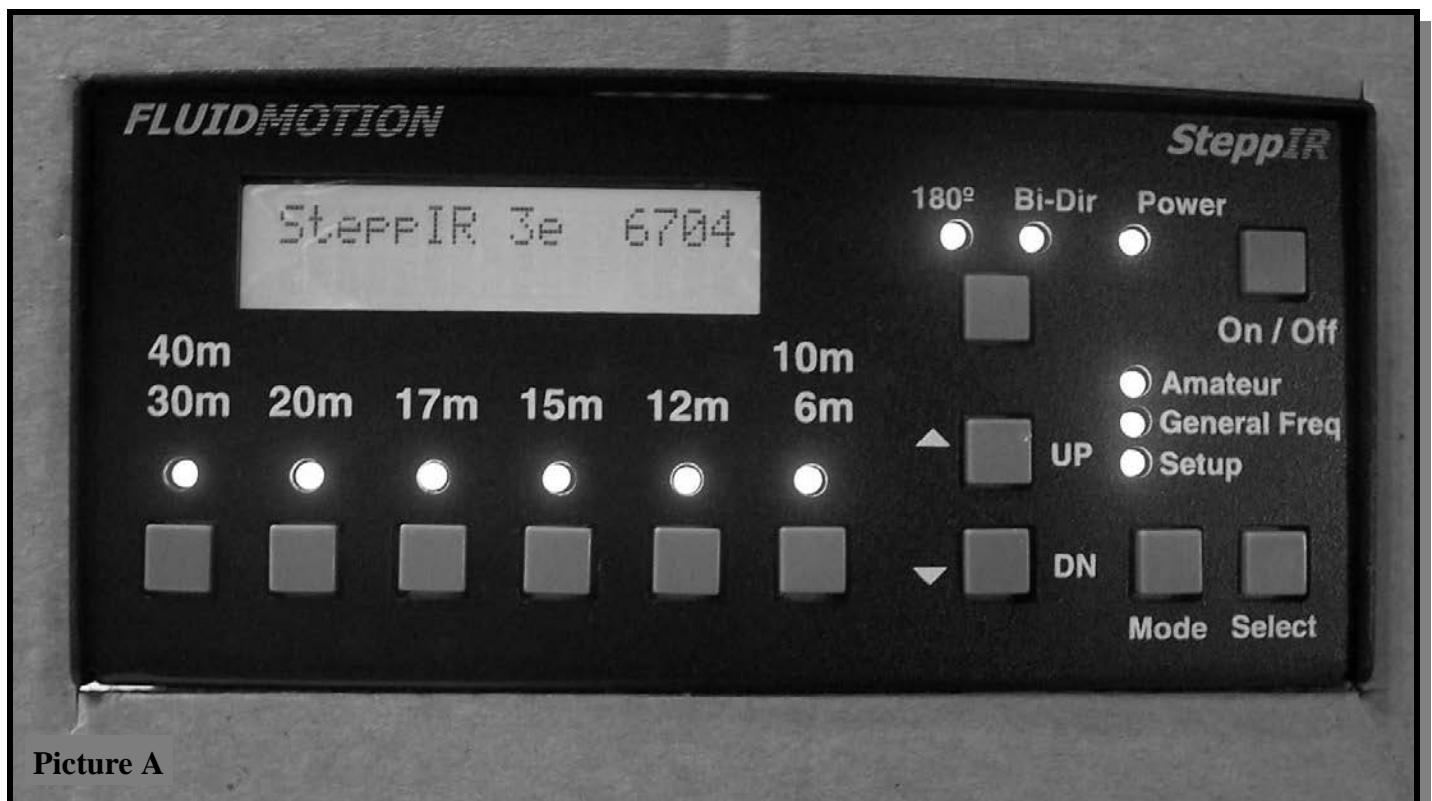

Picture A

Appendix C:

- Retract elements
 - Press 'Mode' button until you see 'Setup Mode' (Setup light will also come on)
 - Press 'Select' button (within 4 seconds)
 - Press 'Up' or 'Dn' button to scroll to 'Retract Elements'
 - Press 'Select' button and 'Home Now ?' will display
 - Press 'Up' or 'Dn' button to select 'Yes' (flashing)
 - Press 'Select' button and the elements will retract (wait until the '*' stops flashing)
- Power off and unplug the controller
- Remove the controller top cover (**Picture 1**)
 - Remove four Phillips head screws (two on each side)
 - Remove the 2 jack screws from the 25 pin D sub connector (and 4 jack screws from the (2) 9 pin D sub connectors if you have the interface option on your controller)
 - Remove the nut and lock washer from the ground stud on the back of the controller
 - Lift the top cover off

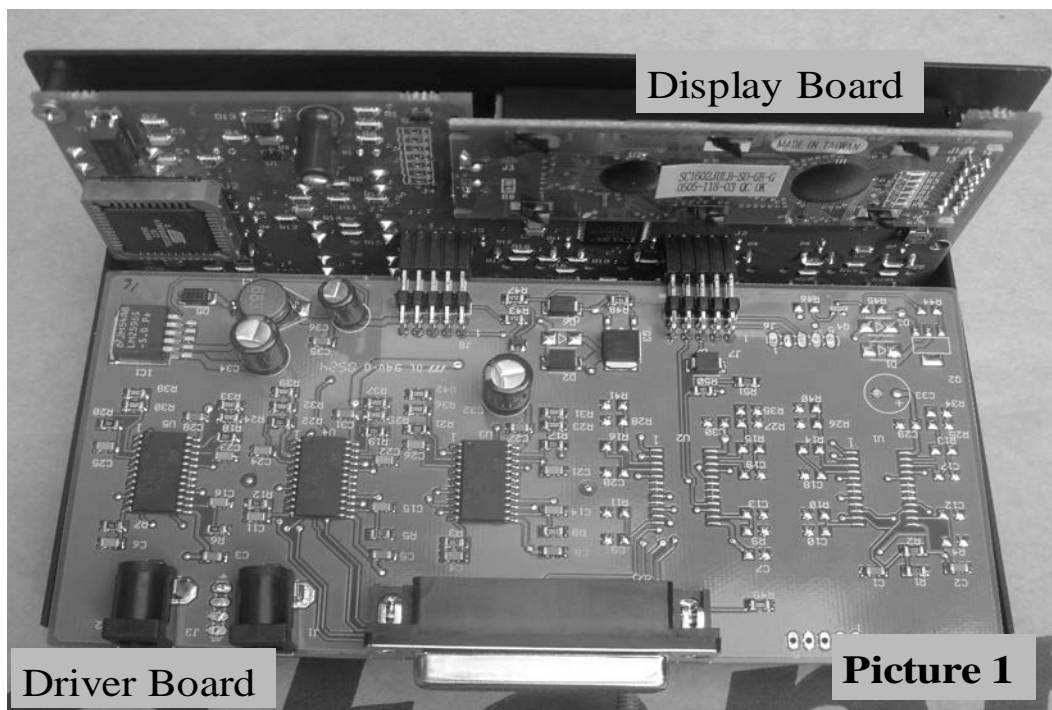

- Unplug the driver board from the display board (**Picture 1**)

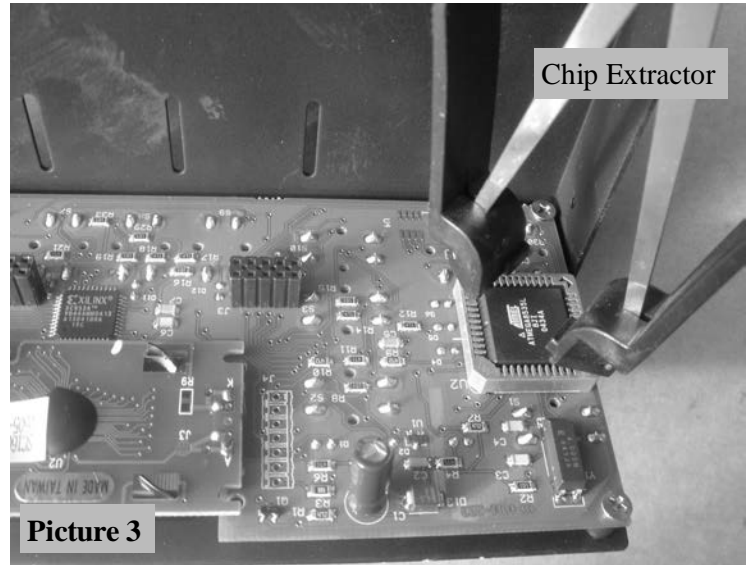
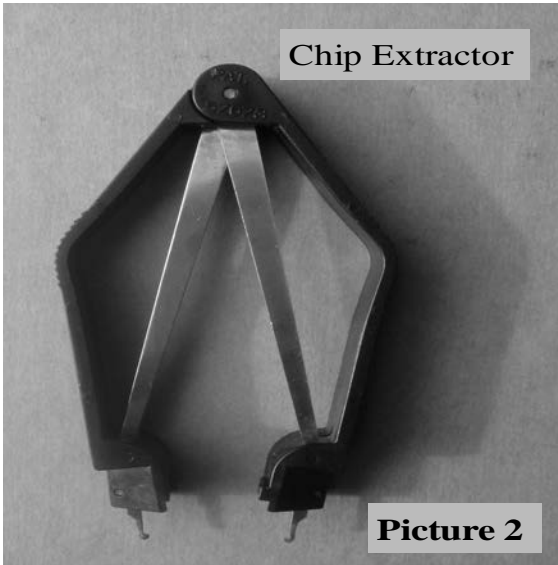

- Use a chip extractor (**Picture 2 & 3**) to carefully pull the chip out of its socket. The tiny “claws” on the extractor fit at the chip corners, and hook under the chip. Gently pull the chip upwards, rocking slightly as necessary until it is free.

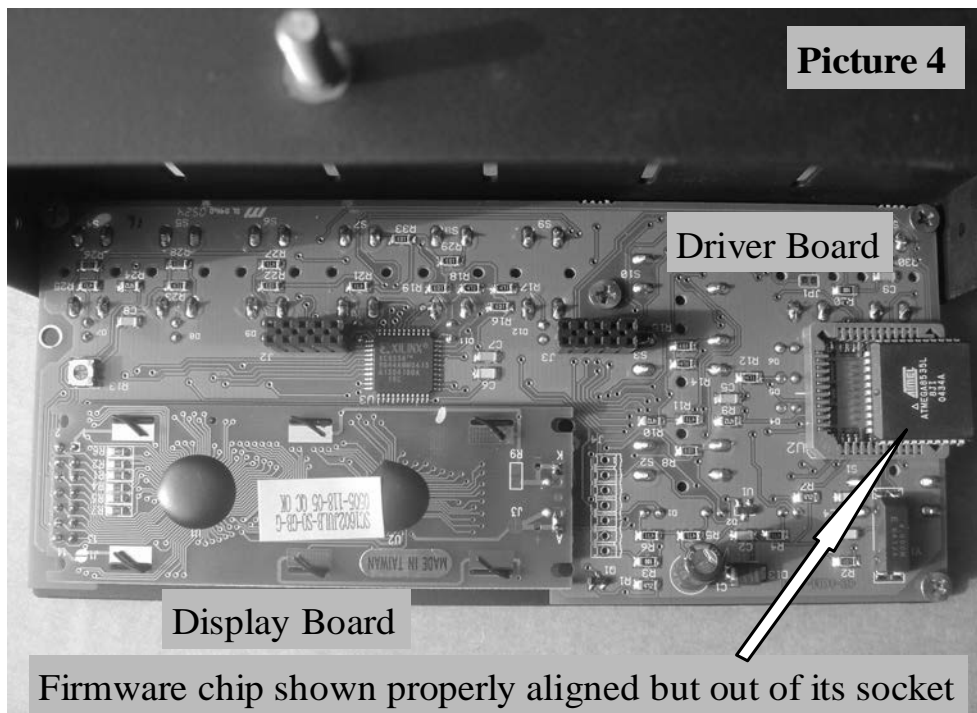

- **Caution:** Using any other tool to remove the chip may damage the pins on the chip
- Align the arrow on the replacement chip to the arrow in the chip socket (**Picture 4**)

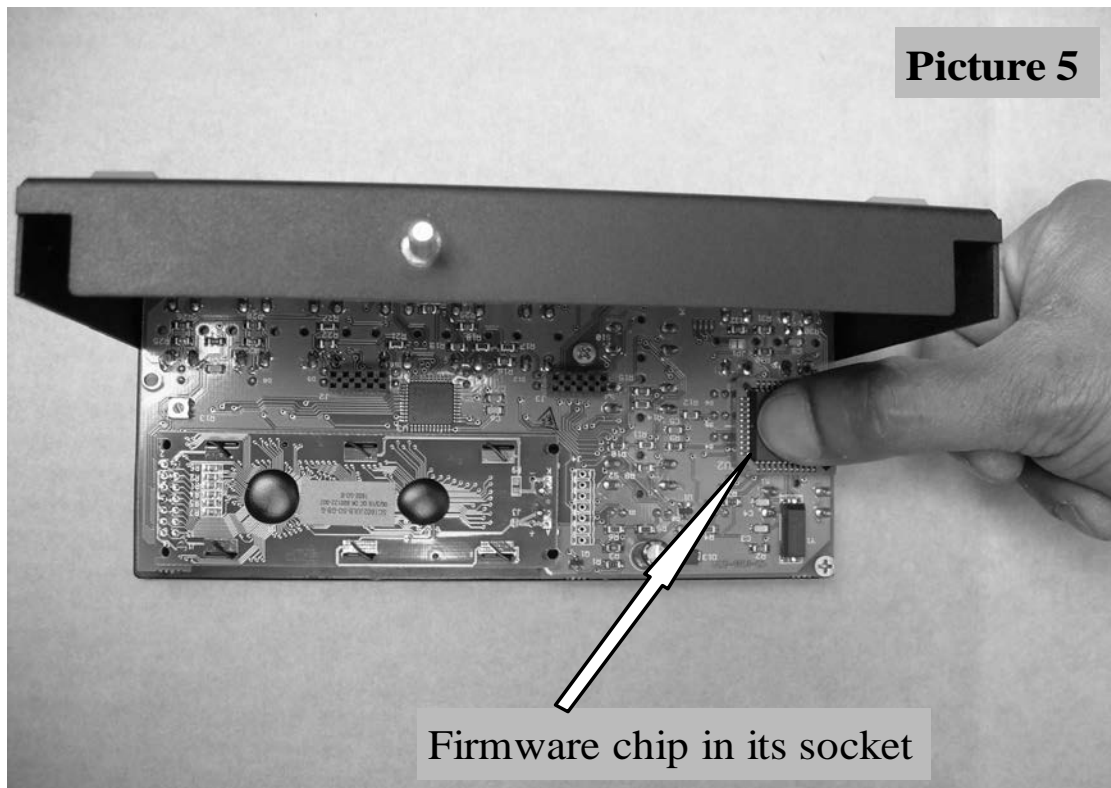

- Center the chip in the socket and press the chip down vertically with your thumb (**Picture 5**). Press evenly until the chip is firmly seated on all sides.
- Reinstall the driver board to the display board (**Picture 1**)
- Reassemble the controller cover

Appendix D: **New SteppIR Controller Firmware** **Version 6.7 or later**

In an effort to improve the operation of the Steppir antenna and to address the problems that can come up in the myriad of installations we have a new version of firmware for all of our Yagis.

Feature list:

- Moved Band defaults to more common frequencies in the HAM mode.
- Moved the center frequency to better center the best SWR.
- Cleaned up messages so they are clearer.
- Frequency is common between Amateur and General Freq Modes.
- Changed Band segments so there is one segment per band.
- Applied changes done in Create Modify to entire band.
- Added New Options menu.
- Added 6M passive selection.
- Added Transceiver Frequency tracking Disable Key.
- Added Global Frequency Offset adjustment.
- Added Global SWR correction.
- Made it possible to program a single button for the Home position.
- Added 40/30 Dipole selection.

Amateur Mode

When the controller is in the Amateur Mode the band buttons 20M-6M (1 through 6) are pre-programmed to get the antenna close to the desired frequency. On the larger bands the buttons have several presets in the band which the controller will cycle through each time the band button is pressed. If the controller is switched between bands using the band buttons it will return to the last preset frequency the button was at.

The Bandwidth will depend on which model antenna you have but it will be at least 100Khz, if you want to fine tune the antenna the UP/DN Keys will shift the antenna frequency in 50Khz steps.

The button below the 180 and Bi-dir LEDs cycles the Steppir through the 3 directions. When both the 180 and Bi-dir LEDs are OUT the antenna is in the Forward or Normal direction. The transceiver interface does not change the frequency in this Mode.

General Freq Mode

When the controller is in this mode there are several options:

- The Transceiver Interface sets the operating frequency.
- The Options menu is selectable in this mode.
- The Band buttons are programmable in this Mode.

If the transceiver interface is disabled or disconnected the band buttons can be used as presets to your favorite frequencies or to Retract (Home) the elements. To save a preset first use the band buttons and UP/DN keys to select the desired frequency. Next Hold the band button in until the LED over it starts to blink. Release the button and press it once more before the LED stops blinking.

In the Case of saving the Home position first use the setup Menu retract elements command. After the elements are Home Press and hold the Band button as before. When you press it the second time the Controller will display 0000Mhz.

The transceiver interface will update the frequency if it is enabled with the radio or computer on overriding the band buttons almost immediately. If using a Band button to home the antenna turn off the Radio first.

Options Menu- This menu is entered by holding the Select Key Down for 3 seconds while the controller is in the General Freq Mode. Due to limited program space the the only sure indication this mode is active will be some of the band LEDs lighting (LED 5 will always light). Also since we have 2 different boxes we will refer to the Band buttons as 1 through 6 with 1 being the 20M or 40/30M button on the far left.

- 1) **Driven Element Offset-** Band button #1 works with the #2 band button Adjust the Driven element to Correct for feed point interactions. Each time the #1 button is pressed the driven element is moved .2" longer. The opposite happens when the #2 button is pressed. The band LED's for these buttons indicate which way the driver has been adjusted (Both Off indicates the default position). This adjustment can correct for higher than normal SWRs when other antennas are interacting and changing the feed point impedance. It will have little to no effect if the antenna is in the clear.
- 2) **6M passive selection-** Button #3 will toggle between having the 6M passive installed or not. The band LED will be lit when the passive element is selected. The lengths for the 6M passive element will be active for the Normal and 180 positions in the frequency range of 50 MHz through 51 MHz. There will be a small "p" in the same location as the saved segment indicator on the LCD display when the 6M passive element lengths are being used. The 6M passive antenna always faces forward even in the 180 mode, Bi-Dir mode will reduce the front to back but the antenna will still have forward gain. This does not effect any other band.

- 3) **40/30 Dipole selection-** Button #4 toggles between having the 40/30 Dipole option installed or not. The band LED needs to be lit when the Dipole option is present to use it. **CAUTION** do not enable this option if the Dipole is not installed, it may be possible to damage your driven element if you do.
- 4) **Frequency Tracking disable-** Band Button #6 is the Transceiver Interface Frequency tracking control toggle. When its band LED is lit the antenna will follow the radio frequency. This only effects frequency tracking, the computer Port (Data Out) can still send commands to the controller.
- 5) **Frequency Offset ADJ-** Using the UP and DN keys the antenna display frequency can be offset from the antenna frequency. There will be a number in the range of +/- 15 displayed in the upper right of the LCD display indicating the offset value. This is a global adjustment to all bands and is based on a percent of frequency. The number is for reference only and does not scale directly. When making this adjustment it is possible to move off the best performance point so some experimentation may be necessary to find the best value.

The changes made in this menu will be saved when the controller power is switched off or after about 3 minutes.

Some notes about adjusting the antenna:

- The firmware frequency is set to what we have determined to be proper for each band, the lowest SWR point may still be at a higher frequency.
- The SWR should be less than 1.5:1 if the antenna is working correctly.
- If the antenna is working properly the SWR in the Normal Mode (Direction) and the 180 Mode should be very close to being the same. Bi-dir Mode SWR varies a lot, do not expect it to be the same or close to the SWRs in the other modes, as it is difficult to create this type of antenna.
- If you are upgrading from older firmware (3x04) you will need to adjust the frequency offset to get the proper frequency display

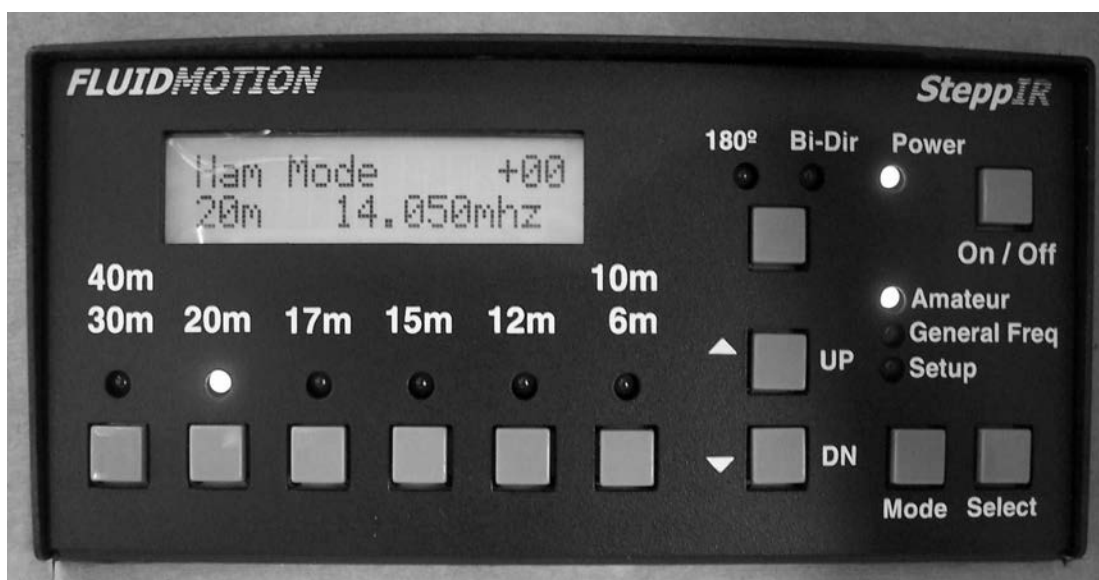

Appendix E: The Most Common Problems (Read this First!)

- The antenna is out of calibration, perform the calibration as described in the manual.
- The factory defaults have been inadvertently changed, reset factory defaults “all”. There are two default modes, “all” and “current”. “Current” only resets the band segment you are currently on.
- The control cable is miss-wired.
- Interaction between power lines, other antennas, metal roofs, house wiring, gutters, etc, and the antenna.
- The automatic tuner is enabled on your rig, your linear or your external tuner that is in-line.
- Your antenna selector is on the wrong antenna, check the coax cable at the shack end with an ohm meter, it should read very close to a dead short.
- Your rig is in the split mode and worse case, to a different band!
- A low pass filter is in-line and 6 meters has very high SWR.
- Your in-line linear has a transmit / receive switch some of which may be poorly designed or faulty. This can make the SWR give incorrect higher readings. Remove as many things in-line on the coax as possible so you get a more accurate SWR reading.
- Low cost SWR meters, especially those built into transceivers, can give incorrect readings, both higher and lower than reality. They also can be drastically affected by the length of the coax line. Removing a few feet of line can cause drastic differences in the reading ranging from 10% to as much as 100%! Directional couplers such as the Bird watt meter or antenna analyzers are much more reliable. Make sure you really have a problem before you hit the panic button.
- Blown driver board from shorting any of the wires in the control cable with power plugged into the controller. Even with the power button pushed “off” the cable is energized.
- Broken or damaged control cable or connector. See Cable Problems section.
- Bad coax or coax connector. We have seen bad coax that an analyzer said was good. Substitution is the sure way.
- Damaged driver board is pulling power supply voltage down causing the microprocessor to malfunction. Check to see if the green LED is lit on power supply
- **Ground the controller**, this prevents crashes of the microprocessor and provides a path for static discharge.
- The rubber plugs that were installed in the telescoping poles for shipping and handling purposes were not removed.
- PL-259 was not tightened with PLIERS – Do NOT trust your fingers – This is a common problem
- Miss-wire causing the stepper motor on one or more elements to run backwards

GENERAL:

Be aware that just because the controller display says an element is a certain length there is no guarantee that it is, the motor could be running backwards due to a miss-wire, the element could have mechanical problems, or a broken wire in the control cable (the motor will run with only one winding driven in some cases) or a faulty driver board. The controller runs open loop and has no way of knowing if the element is really moving. The motors in the elements make three distinct noises:

1. A ratcheting sound lasting 1 – 2 seconds at the start and finish of the motor running. This is the rpm ramp-up the stepper motors require and is normal.
2. A smooth whirring sound indicating normal operation.
3. A loud rattling sound that sounds like gears slipping indicates the stepper is stalling. This occurs during the middle portion of a “calibrate” with the smooth running sound before and after it and is normal. Any other time (even for brief durations) this noise indicates unwanted stalling of the motor and should be investigated.

Check the resistance with an ohmmeter between the center conductor and ground of the coax connected to the antenna, it should read zero ohms.

HIGH SWR:

Whenever the antenna has a problem you will most likely observe higher than expected SWR. However, this is not always the case, as there are many situations where the SWR looks good but one element on the antenna may not be working at all. This is what makes it so difficult to diagnose problems and why we emphasize **building and wiring the antenna carefully**. In our experience an SWR of 1.4:1 or less is normal. In most cases the lowest SWR will not be at the same frequency as the best performance. This is because we have optimized the antenna for performance first, SWR second.

If the problem is with the driven element the SWR can be very high (over 3:1 and as high as 10:1). If the problem is with a passive element the SWR will not be over about 3:1 no matter how far off the passive element is.

INTERACTION PROBLEMS:

The most common reason for higher than expected or shifted SWR is unexpected interactions. Usually only one or two bands are affected but not always and the antenna will probably have reasonable gain and front to back. It is important to take good notes so if you need to call us we can do a better job of helping you. Record the SWR on each band and each direction mode at least one place in the band, this is a good idea anyway so you can assess the health of your antenna over time. Rotate the antenna and look for changes in SWR greater than .2 or so, this indicates interaction if it changes very much. The usual culprits are wire antennas, other nearby antennas, gutters, power lines, house wiring, metallic guy wires, etc. If the SWR is not too high you can “tune” it out by using the “Create, Modify” mode to adjust **only the driven element** for best SWR and save it as described in the manual. Don’t adjust the passive elements to improve SWR it will degrade the performance. Adjusting the driven element won’t. Otherwise you will need to change your installation to reduce the interaction to an acceptable level.

CABLE PROBLEMS:

The control cable uses 4 wires per motor (one motor in each element housing). Each motor has two wires for each of its two motor windings. This test assumes the antenna is connected to one end of the control cable and the measurements are taken at the 25-pin connector that mates to the controller. You need a ohmmeter capable of measuring 15 – 35 ohms with reasonable resolution or at least one that you can tell the difference between a dead short and 15 ohms. Remove the 25-pin D sub control cable connector from the controller. Hold it so you are looking at the pins with them pointing at you. Orient the connector so the row with 13 pins is on top, now the upper left-hand pin is pin 1. You should read between about 18 ohms to 30 ohms depending on cable length between the pins listed below. (100' is about 23 ohms)

The Dipole: (has a driven only)

Pin Numbers

Driven	1 – 2	20 ohms (approximately)
	3 – 4	20 ohms

The 2 Element: (has a driven & director)

Pin Numbers

Driven	1 – 2	20 ohms (approximately)
	3 – 4	20 ohms
Director	5 – 6	20 ohms
	7 – 8	20 ohms

The 3 Element: (has a driven, director & reflector)

Pin Numbers

Driven	1 – 2	20 ohms (approximately)
	3 – 4	20 ohms
Director	5 – 6	20 ohms
	7 – 8	20 ohms
Reflector	9 – 10	20 ohms
	11 – 12	20 ohms

The 4 Element & MonstIR: (each have a driven, director 1, director 2 & reflector)

	<u>Pin Numbers</u>	
Driven	1 – 2	20 ohms (approximately)
	3 – 4	20 ohms
Director 1	5 – 6	20 ohms
	7 – 8	20 ohms
Reflector	9 – 10	20 ohms
	11 – 12	20 ohms
Director 2	14 – 15	20 ohms
	16 – 17	20 ohms

Next make sure there is an open circuit between the following pins. (Any reading less than 100 K ohms is bad)

- Connector case to any pin
- pin 1 to any pin except pin 2
- pin 3 to any pin except pin 4
- pin 5 to any pin except pin 6
- pin 7 to any pin except pin 8
- pin 9 to any pin except pin 10
- pin 11 to any pin except pin 12
- pin 14 to any pin except pin 15
- pin 16 to any pin except pin 17
- pin 13 is NOT used

If your antenna passes this test it **does not** mean it is wired correctly. You could still have swapped two elements or even wired the whole thing backwards (started at the wrong end of the terminal strip) and it will still measure correctly because each connector pair has a motor winding connected to it but it is the wrong one. This test just takes you to the next step of trying to determine if the antenna is wired correctly and then finally determining if the elements are physically moving. This is an open loop system and the controller has no way of knowing if the elements are really moving when commanded to.

MISS-WIRED CABLE:

It can be a difficult to figure out what exactly has been miss-wired. Once you have determined it is likely you have a miss-wire, it is advisable to go up on the tower and check the terminal wiring. Since there are many combinations of incorrect wiring we will give just a few examples of common miss-wires and the symptoms they cause.

- **Two or More Elements are Swapped:**

This is easy to do if you don't mark the 4 conductor cables before you tape them along the boom. The SWR will usually be high on every band. Often by changing the controller frequency, while keeping the transmit frequency fixed, the SWR may go quite low at a higher or lower controller frequency. In any case of SWR problems don't be surprised if the SWR is okay when you switch to the 180 degree mode. If it isn't good in the forward mode you have a problem.

- **If you Suspect Elements are Swapped:**

First try to identify which one is the driven element. You can identify the driven element easily because it has a much greater effect on SWR than the passives do. The driven element is also very easy to identify by retracting all of the elements and then use "Create, Modify" to extend each element individually until signals are heard in the receiver. Obviously you will only hear signals when the driven element is extended. The best way to determine if the passives are switched is to point the antenna in the normal mode at a station you know the location of and then switch the antenna to 180-degree mode, if he gets stronger you probably have switched the passives. If it seems like they are switched you can use "Create, Modify" mode to "swap" the elements back by first recording what the controller says each one should be and then go put the reflector length into the director and vice-versa for the director. If the antenna now works normally you have swapped the cables of the two passives and will need to correct the wiring.

- **One or More Elements are not Moving:**

If the driven is not moving you will have very high SWR at all frequencies. However, it may have stopped at some length and you might have good SWR only at one particular frequency. Set the controller to 14.200 Mhz and monitor the SWR at that frequency. Next go into the "Create, Modify" mode and vary each element length and monitor the SWR while you do it (100 watts or less is okay) and watch for dramatic changes (.5 SWR change, minimum). When you adjust the driven element driven you should be able to get an SWR of 5:1 or greater. Always return the element you have just tested to its original length before testing the next one. The passive elements can only cause an SWR of 3.5:1 maximum no matter what length you make them. Adjust the passive elements from minimum length to maximum length and you should see at least a .5 change at some point. When the passive element is near the length of the driven element interaction is the greatest and you should see very noticeable change in SWR. You will find that Director 2 (on 4 element models) has much less of an affect on the SWR because it is so far away from the driven element, but you should still see at least a .4 change in the SWR reading. A classic symptom of one passive element not moving is a high SWR in the normal direction and a markedly better SWR in the 180 direction.

If any element does not affect the SWR the cause is one of the following:

- Bad or intermittent cable, check it again.
- Damaged driver board in the controller
- Mechanical problem with the element

Be aware that lightning or shorting the cable can partially disable a driver chip and it will still limp along moving the tape but you will see inconsistent SWR when changing from band to band.

Mechanical problems can range from an obstruction in the element, usually in the tip, such as packing material or in rare cases fiberglass bumps or imperfections. We check this by running a gauge in the tip but once in a great while that doesn't catch it. **DO NOT ever tape or block the end of the element tip, water can collect and freezing can cause a blockage or trap the element.** The foam plug must be left in the tip so wind driven rain and bugs are kept out but the element can breathe.

- **Stepper Motor Running Backwards:**

A simple miss-wire can cause one or more element stepper motors to run backwards. Simply swapping the Black and Red wires or the Green and White in the 4 conductor cable will cause the motor to run backwards. If both pairs get swapped the motor will run normally.

Motor Runs:

o----- Black

o----- Red

o----- Green

o----- White

Normal

Motor Doesn't Run:

o----- Black

o----- Green

o----- Red

o----- White

Driver Board Damaged

o----- Red

o----- Black

o----- Green

o----- White

Backwards

o----- White

o----- Green

o----- Red

o----- Black

Backwards

o----- Red

o----- Black

o----- White

o----- Green

Normal

If the driven is wired backwards when you first command the antenna to go to a specific band the driven tries to go in (retract) and it can't so you hear no signal (unless it is an S9 + ++ signal) and the SWR will be very high. If you retract or go to a higher band the driven will start going out and you will hear signals and band noise. The SWR will probably be terrible but with a little imagination you can see that you might hit some combination where the SWR looks good, so this type of miss-wire can be very confusing.

The driven is the easiest to diagnose in this case. Passives are a little tougher. Run the element you want to test all the way out then all the way in using the "Create Modify" function and carefully look for a good SWR. If a director starts working at 4.5" or at very short lengths you can be sure that motor is running backwards

Appendix F:

Replacing the Driven Element Bracket (Original 3 element only)

For customers who purchased a 3 element antenna **before March 2003** your element housing brackets may have been of a different design (**Figure 3-C**). If you have the original style element housing bracket you will need to install a new style element housing bracket on your boom (**Figure 3**) before you can mount the new 40m - 30m driven element housing unit.

A 3 element boom layout drawing (Figure 1) is provided to give you the necessary dimensions to install the new element housing bracket as well as the new element return bracket.

Remove Existing Driven Element & its Bracket:

- **Retract all elements:**
 - Using the controller:
 - Go to “Setup” mode and press ‘Select’
 - Using the ‘UP’ - ‘DN’ buttons find “Retract Elements” and press ‘Select’
 - Using the ‘UP’ - ‘DN’ buttons find “Yes” and press ‘Select’
 - Wait for the “ * ” to stop flashing
 - The elements are now retracted
 - Disconnect the coax and control cable for the driven element
 - Loosen the clamps holding the two quick disconnect rubber boots securing the fiberglass telescoping poles
 - Remove the two fiberglass telescoping poles (FTPs) from the driven element housing
 - Remove the driven element housing unit from its mounting bracket
 - Remove the driven element housing mounting bracket from the boom

Install the New Element Mounting Bracket:

- **Drilling instructions**
 - Measure & mark the boom to install the new bracket per **Figure 1**.
 - Secure the return bracket firmly in place with some type of clamp
 - Make sure to level the bracket with respect to the other element brackets using either a level or actually mounting the element and eyeballing it.
 - Drill four 5/16” holes, two in from each side, through the bracket and the boom. You will **NOT** be using the original holes in the boom.

Warning:

Make sure that the bracket does not slip or twist while drilling.

Keep the drill straight while drilling to produce a clean round hole. It may be helpful to drill both holes for one bolt and then install that bolt providing more positive alignment for the second pair of holes.

- Install the two 5/16” bolts with Nylok nuts & tighten. These bolts should fit as snug as possible in the holes.

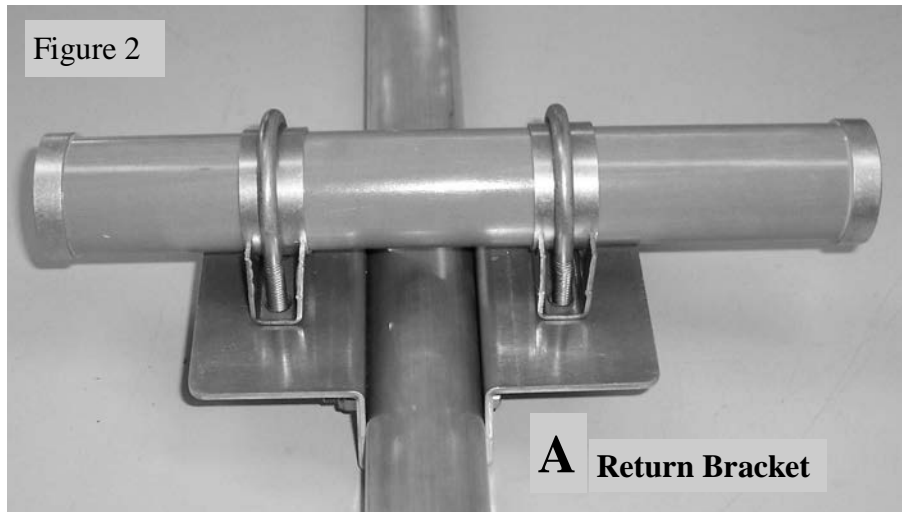
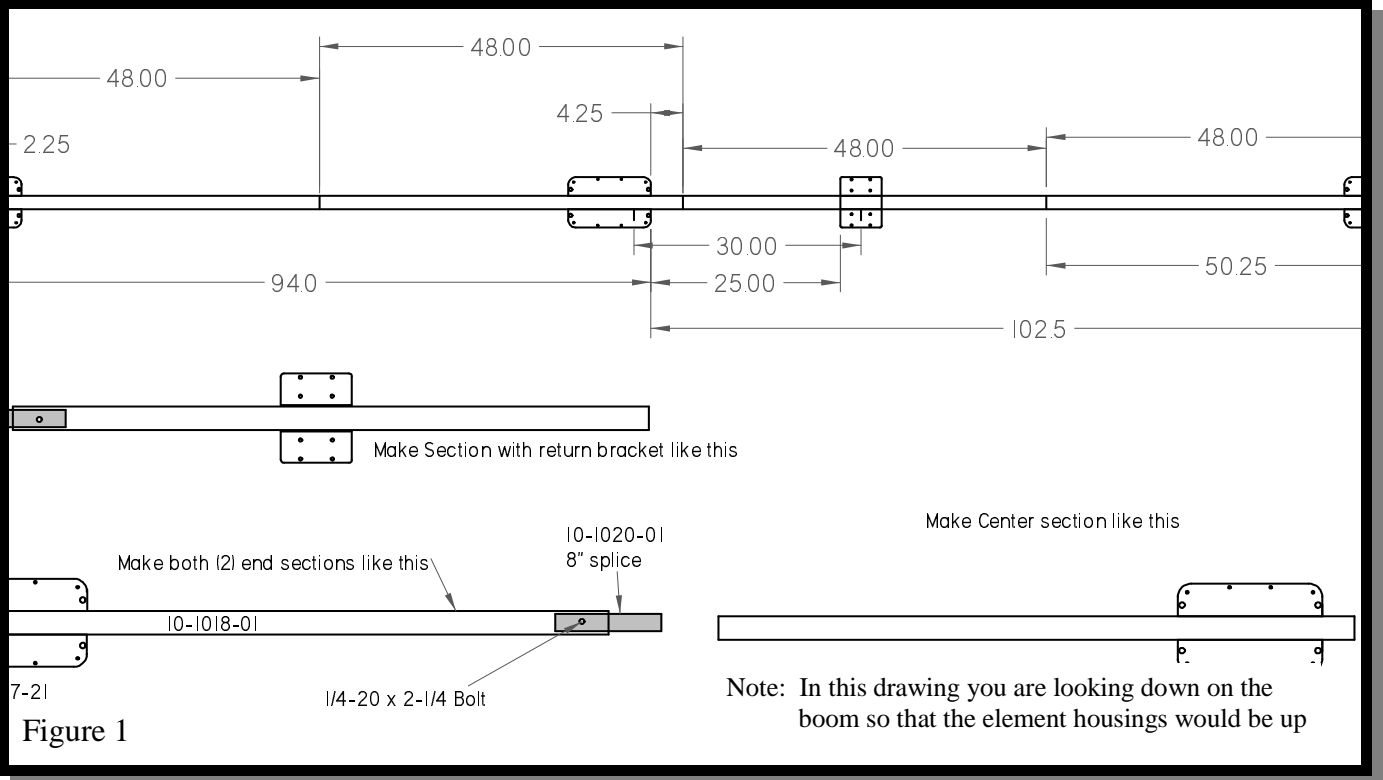

- A - Return bracket for the 40/30 loop
- B - Current element housing bracket
- C - Original element housing bracket

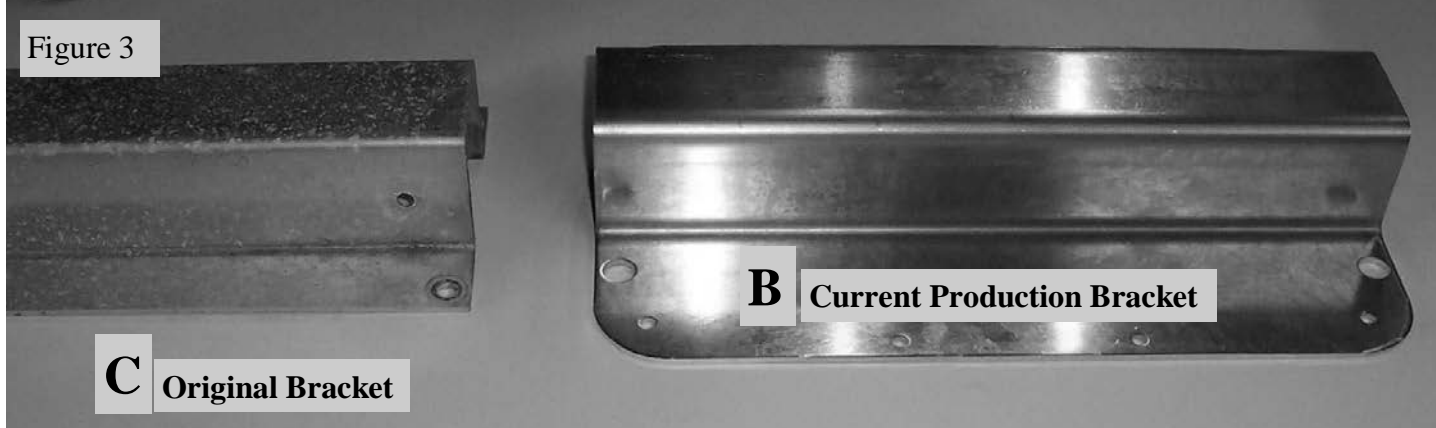



Limited Warranty

These products have a limited warranty against manufacturer's defects in materials or construction for two (2) years from date of sale. Do not modify this product or change physical construction without the written permission of SteppIR Antennas Inc. This limited warranty is automatically void if the following occurs: improper installation, unauthorized modifications, physical abuse or damage from severe weather, beyond the manufacturer's control. Manufacturer's responsibility is strictly limited to repair, or replacement of defective components. The shipping instructions will be issued to the buyer for defective components, and shipping charges will be paid for by the buyer to the manufacturer. The manufacturer assumes no further liability.

Thank you for choosing SteppIR!!



SteppIR TM
Antenna Systems

Yagi • Dipole • Vertical

www.steppir.com