



HM218-L 3-piece mast mount collinear Marine HF 2-30 MHz



The HM218-L is suitable for all HF marine communications within the 2-30MHz range. These antennas offer top performance together with a 3-piece construction enabling easy dismantling and reduced storage area required.

This antenna is designed to couple with transmitters via an Antenna Tuning Unit (A.T.U.). Please check whether A.T.U. specification will load the given length of radiator for this antenna at your lowest frequency required.

Mounting hardware, water-proofing, bird proofing and other installation accessories are all available separately.

Construction	2-section white radome, chrome joining ferrules, 2-piece 316 stainless steel mount section and external cable
Frequency range	2-30 MHz - Marine HF, when combined with <u>suitable A.T.U.</u>
Tuning	Field tuning using A.T.U.
Gain	2.1 dBi
Maximum power	500 Watts PEP
Impedance - nominal	An A.T.U. is required to match to 50 Ohms
Polarisation	Vertical
Cable	6 metres 20kV single core cable
Termination	Stainless steel termination lug 25mm x 25mm
Height assembled: Height packed:	7.5 metres 3.4 metres
Weight	5.9kg
Projected area	0.161m ²
Wind load at 160kph	19.559kg, 0.192kN
Mount section	2-piece 316 stainless steel 2.0m x 38.1mm ϕ
Mast mounting order separate	2 x UAM180L-316 heavy-duty parallel clamps or 2 x UAM90L-316 heavy-duty right-angle clamps
Side/wall mounting order separate	2 x NSM-218
Mounting position recommended	Mount as high on your vessel or structure as possible using appropriate mounting hardware. Ensure no obstructions around antenna.
Installation tools required	16mm spanners for sectional securing 32mm spanner for mount section securing

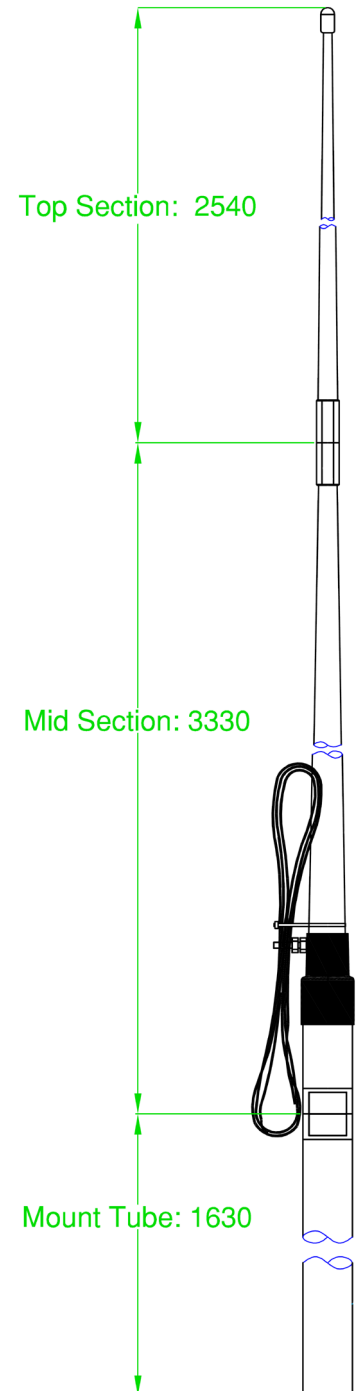



HM218-L

3-piece mast mount collinear
Marine HF 2-30 MHz

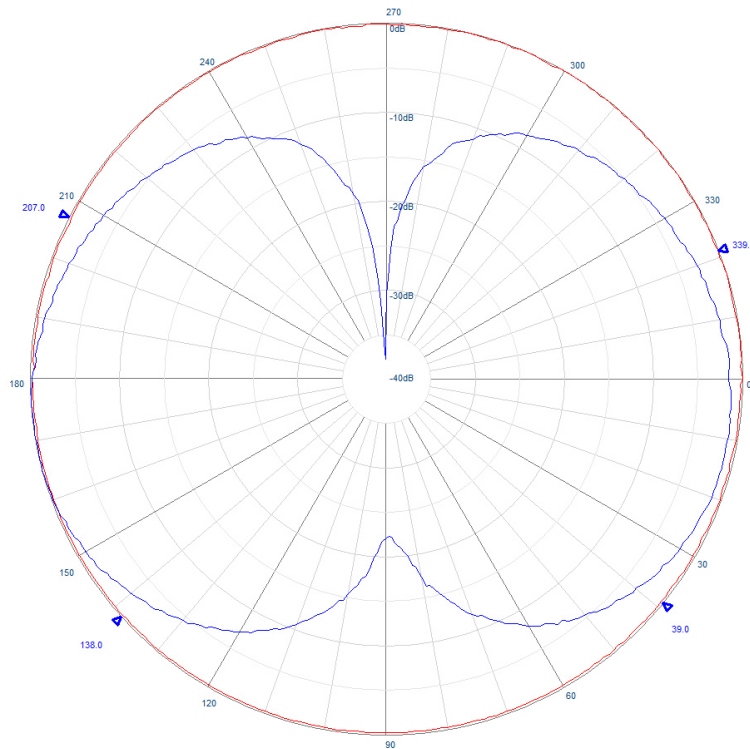





Example radiation pattern

HM218-L

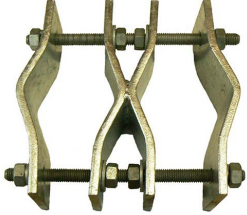
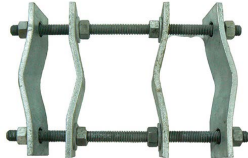
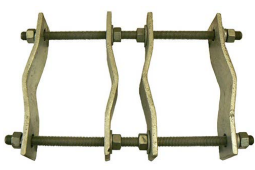
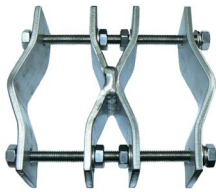
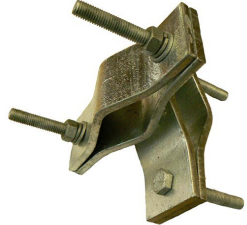
3-piece mast mount collinear Marine HF 2-30 MHz

Suitable mounting hardware

 <p>UAM180L Galvanised steel heavy-duty parallel clamp Boom: 40-75mm capability Mount pole: 40-75mm capability</p>	 <p>UAM180UNI Galvanised steel large heavy-duty parallel clamp Boom: 40-70mm capability Mount pole: 40-90mm capability</p>
 <p>UAM180UNIL Galvanised steel extra large heavy-duty parallel clamp Boom: 40-90mm capability Mount pole: 60-115mm capability</p>	 <p>UAM180L-SS316 316 grade stainless steel large heavy-duty parallel clamp Boom: 40-75mm capability Mount pole: 40-75mm capability</p>
 <p>UAM90L Galvanised steel heavy-duty right-angle clamp Boom: 40-75mm capability Mount pole: 40-75mm capability</p>	 <p>UAM90UNI Galvanised steel large heavy-duty right-angle clamp Boom: 40-70mm capability Mount pole: 40-90mm capability</p>
 <p>UAM90LL Galvanised steel extra large heavy-duty right-angle clamp Boom: 60-115mm capability Mount pole: 60-115mm capability</p>	 <p>NSM-218 Toughended nylon wall/side mount Boom: 38mm Mount hole: 16mm</p>