

bhi Ltd

User Guide for the bhi ParaPro EQ20 Range of Audio DSP Products



ParaPro EQ20-DSP/EQ20B-DSP



ParaPro EQ20/EQ20B

Introduction

Thanks for purchasing a bhi **ParaPro EQ20** product with parametric equalisation. The **ParaPro EQ20** range of audio DSP units will improve the quality of your receive audio. They feature a 20W modular audio power amplifier with a parametric equaliser, plus the option of the latest bhi dual Channel DSP noise cancelling technology and Bluetooth connectivity on the input. The parametric equaliser allows any specific part of the frequency range to be selected and adjusted in strength to suit your conditions. You can adjust the controls to determine exactly how the equalization is applied, allowing you to select which frequency to adjust. This gives you greater flexibility and accuracy to set the audio to suit your own hearing. The **EQ20** range can accept standard mono inputs and outputs as well as stereo signals. The basic **EQ20** unit without DSP noise cancelling can be used enhance your current audio, or use it with your existing bhi DSP unit. If you suffer with noise and interference then the **EQ20-DSP** noise cancelling

version would be a good option, greatly improving your audio communication so that you can listen stress free without all the annoying background noise and interference.

The bhi DSP noise cancelling versions provide mono and stereo DSP noise cancellation to improve the speech quality in all types of radio and voice communications. The Bluetooth versions allow you to transmit audio from your Bluetooth enabled device through to the **EQ20**, effectively turning your wired speakers that are connected to the **EQ20** unit into Bluetooth speakers.

Each new **ParaPro EQ20** unit is supplied with a selection of cables and connectors to enable you to connect to your radio and speakers or headphones and start enjoying the superb audio quality of your bhi **ParaPro EQ20** audio DSP unit with parametric equalisation.

Accessories and options

Order code: EQ20 – Basic ParaPro EQ20 without Bluetooth installed

Order code: EQ20B – Basic ParaPro EQ20 with Bluetooth installed

Order code: EQ20-DSP – DSP version of ParaPro EQ20-DSP without Bluetooth installed

Order code: EQ20B-DSP – DSP version of ParaPro EQ20-DSP with Bluetooth installed

Your bhi ParaPro EQ20 product is supplied with the following:

1 x ALD-007 - 3.5mm stereo jack plug to 3.5mm jack plug lead 1.2M long.

2 x ALD-001 - 3.5mm mono jack plug to 3.5mm mono jack plug lead 1.2m long.

2 x 4mm red banana plugs – 2 x red banana plugs with screw terminals for speaker connection

2 x 4mm black banana plugs - 2 x black banana plugs with screw terminals for speaker connection

1 x 1030-FPL – Fused DC power lead

2 x ADP-P004 - Phono Plug to 3.5mm Mono Socket

Quick start user guide

Feedback card

Optional extras:

1 x PSU12-2A-WW – 12v 2A 12V 2A 24W International Power Supply, 2.1mm plug Centre +VE Level 6.

Before you Begin

Using the rear panel diagram and descriptions of each connection on pages 3 & 4, connect your equipment to the sockets on the rear of the unit, using the cables supplied to suit your own setup. Connect the power. **Note:** For a standard mono speaker level signal connection, connect the ALD-001 3.5mm mono plug lead to the extension speaker socket of your radio and the other end to CH1 input on the rear of the EQ20. Connect your mono speaker lead to either speaker output on the rear of the unit (right or left). Use the ADP-004 adapter if your speaker lead is terminated with a 3.5mm mono plug. For stereo connections or two channel use, use a combinations of the ALD-001 and ALD-007 audio leads.

Using the unit

Once you are ready to use the unit turn the power supply on and switch the EQ20 unit on using the green on/off button. Switch on your radio, receiver or audio source and set the various controls to tailor the audio to your own individual taste. Press the “Sel” button to select your audio.

Try adjusting the Bass and treble controls along with the boost or cut function for each control to give you the best audio for your ears. For the EQ only units without DSP this will just be a case of adjusting the audio. For EQ-DSP users there is the added feature of adjusting the DSP noise filter to remove noise and interference to give you improved speech quality. Increasing the “**DSP Noise Filter**” (12) control will further reduce the background noises and enhance any voice signals. Adjust the unit until you find a suitable filter level for the current signal you are listening to.

You may find that you have to increase the appropriate Volume Level after increasing the filter level as the effect of the noise reduction reduces the mean audio level so that everything sounds quieter (this is because you have reduced the noise level significantly). You can get a feel for how much clearer the Noise Reduction is making the signal by turning the “**DSP Noise Filter**” (12) control fully anticlockwise to DSP off, and then clockwise back to the selected filter level. Note that the DSP algorithm may take a short while to take full effect, approximately 500 ms, dependent on the noise content of the signal.

Bluetooth

The Bluetooth function is enabled by pressing the “Sel” (6) until the Bluetooth LED illuminates. Once you have done this make sure that you enable the Bluetooth scan function on your Bluetooth input source device so that you can pair with your EQ20 unit. You should see a Bluetooth device named “bhi ParaPro-xxxx” identified in your Bluetooth device list. Connect to this device and you will then be connected via Bluetooth to your Bluetooth enabled bhi ParaPro EQ20 unit. Select the audio on your device and this should now play out of the speakers that you have connected to your device or through headphones if connected to the front of the unit (9). This in effect turns your speakers into Bluetooth speakers. Adjust the volume control on your device as well as the Volume control on the EQ20 unit to get the desired audio output. Adjusting the Bass and treble controls along with the boost or cut function for each control to give you the best audio for your ears. For the EQ only units without DSP this will just be a case of adjusting the audio response to suit your ears. **Note:** See the section “Notes for EQ User Guide” for a more in depth explanation of the input signal levels and parametric equaliser settings.

Front Panel Controls and display indications

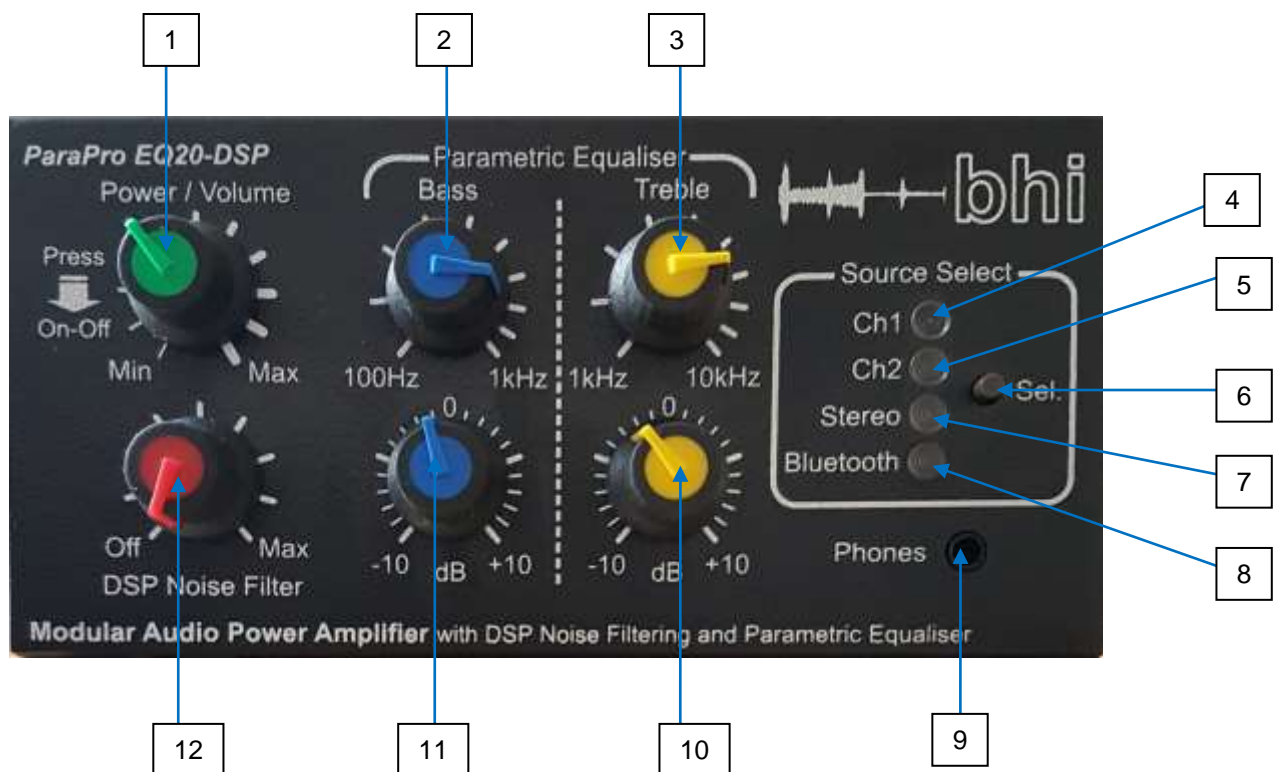

Rear Panel connections

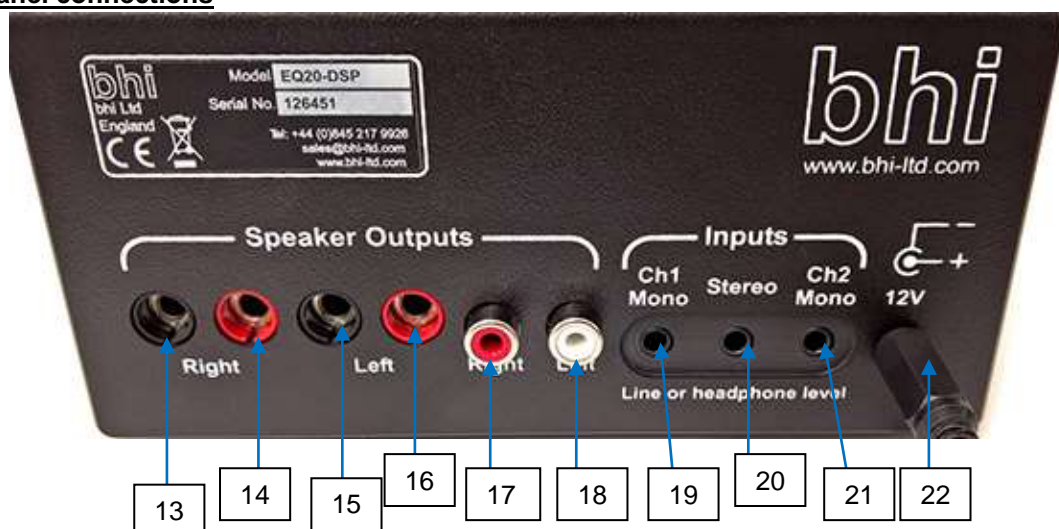

Input connections

- 19 – Ch1 3.5mm mono socket
- 20 – Stereo input, 3.5mm stereo socket (Main connection for stereo line level inputs)
- 21 – Ch2 3.5mm mono socket
- 22 – 12V DC input socket, 2.1mm centre positive (2A)

Audio output connections

- 13 – Speaker output Right channel gnd, 4mm socket (Black)
- 14 – Speaker output Right channel signal, 4mm socket (Red)
- 15 – Speaker output Left channel gnd, 4mm socket (Black)
- 16 – Speaker output Left channel signal, 4mm socket (Red)
- 17 – Speaker output Right channel RCA phono socket (Red)
- 18 – Speaker output Left channel RCA phono socket (White)

Front Panel Controls and connections

- 1 - Power on/off volume control. Push to switch the unit on and off (source select LED's will light in sequence). Rotate clockwise to increase volume.
- 2 – Bass tone control 100Hz to 1 kHz. Rotate clockwise to increase Bass frequency (use in conjunction with Bass boost or cut control. See Notes for EQ20.
- 3 – Treble tone control - 1 kHz TO 10 kHz. Rotate to treble increase frequency (use in conjunction with treble boost and cut function). See Notes for EQ20.
- 4 – Ch1 select LED. Lights orange when Channel 1 is selected.
- 5 – Ch2 select LED. Lights red when Channel 2 is selected.
- 6 – Audio input select button. Press to select input source.
- 7 - Stereo audio select LED. Lights green when stereo audio is selected.
- 8 – Bluetooth select LED. Lights blue when Bluetooth is selected. Pair with input device Bluetooth and play audio through EQ20 via Bluetooth.
- 9 – 3.5mm stereo socket. Stereo headphone socket. Listen with stereo headphones. Speaker output muted once headphones are plugged-in.
- 10 – Treble boost or cut control. Boost or cut your selected frequency by + or – 10dB.
- 11 - Bass boost or cut control. Boost or cut your selected frequency by + or – 10dB.
- 12 – DSP noise filter control. Fully anticlockwise audio bypassed DSP not selected. Rotate clockwise to increase filter level from 9 to 40dB of noise reduction.

Notes for EQ20 User Guide

Input signal level

The input signal(s) must be as high as possible that does not cause clipping. This will ensure the best possible performance of the DSP noise filtering function.

The currently selected input channel is shown with an illuminated LED. That LED will flash rapidly for 1.5 seconds if it detects a peak in the signal that is likely to cause clipping.

The input signal level is controlled from the signal source equipment (not the EQ20 unit). Adjust the source level so that it is marginally below the level that causes the LED on the EQ20 unit to start flashing (overload detection).

Very occasional flashing of the LED is ok, there is some margin before the onset of clipping occurs.

Clipping distortion can be very severe if the input signal is much too high, so ensure your source signal is not too high.

Signal-to-noise-ratio and also the performance of the DSP noise filtering will not be optimum if your input signal is much too low. An input signal “just” lower than the clipping limit is ideal.

Remember, the input signal level is controlled from your source equipment, not the EQ20 unit!
--

Top Tips

1. Adjust your source signal to the maximum possible that does not cause the clipping warning to occur. Nominal input should be around 0.9Vpk-pk.
2. When the input signal level is set (on your source equipment), adjust the listening volume on the ParaPro only.
3. The speaker outputs are Class-D type to maximise power efficiency and eliminate the need for bulky heat sinking. **For this reason, do not ground any of the speaker outputs or connect any of the speaker outputs together.**
4. To minimise RF emissions from the ParaPro EQ20, keep speaker connections as short as possible.
5. The headphone outputs are Class-AB with a common ground to the input supply and input signals.
6. To minimise interference from external high power RF sources, do not join the external ground connections of the ParaPro EQ20 unit together, doing so will bypass the internal RF filtering.
7. Use only a good quality power supply of nominally 12V (or 13.8V) at 3A. Linear power supplies are best for audio and RF applications.
8. We recommend that you use a separate 12V DC power supply like the **PSU12-2A-WW** with your EQ20 unit. This helps minimize potential ground loops and RFI issues.

Parametric Equaliser

The EQ20 Parametric Equaliser allows you to shape the frequency response of the audio path. Unlike a graphic equaliser, the EQ20 Parametric Equaliser allows you to adjust the frequency of any cut/boost function. With a graphic equaliser, the frequency bands are fixed and can yield a very discontinuous response.

The key to understanding the behaviour of the EQ20 Parametric Equaliser is to consider it as 2 very flexible “shelving filters”. Consider the Bass filter first:

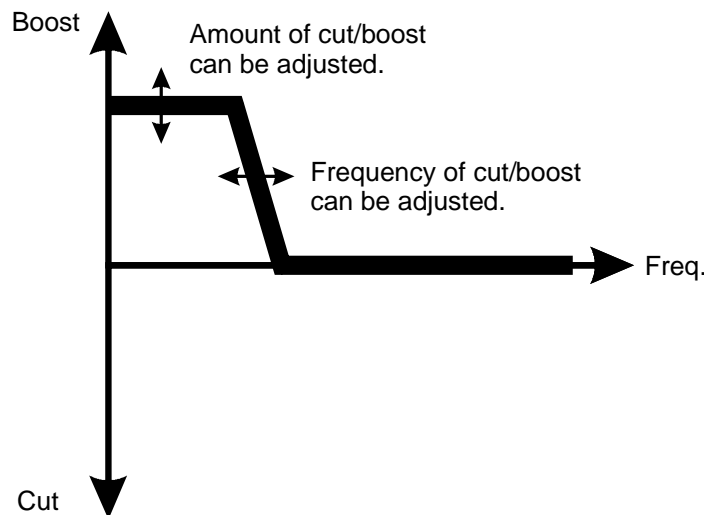

The Bass controls allow you to adjust the amount of cut or boost that occurs below your selected frequency adjustment.

Now consider the Treble filter:

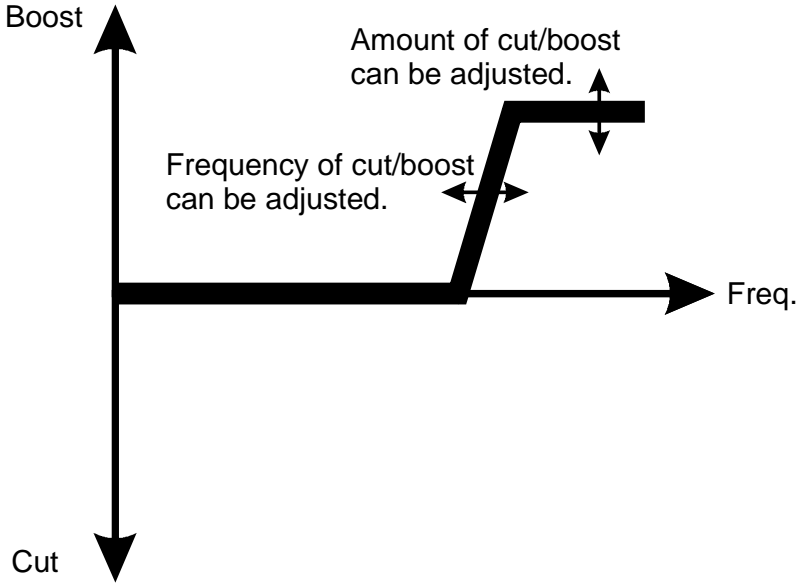

By combining the two filters, a variety of response shapes can be created, suiting your listening tastes, source characteristics, speaker characteristics and room acoustics.

Here are some examples which illustrate that the amount of cut or boost and the frequencies at which they occur are all continuously variable:

Flat response

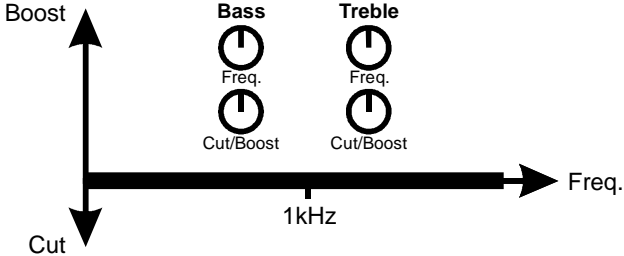

Bass boost and no treble cut or boost

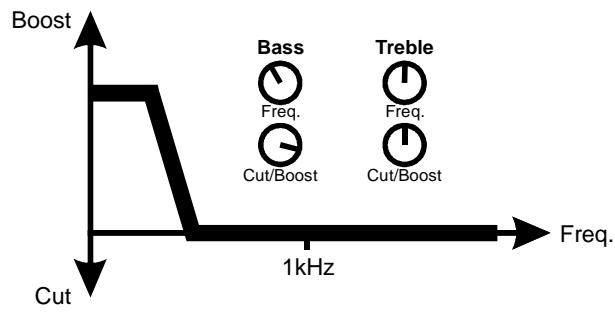

Bass boost and some treble cut

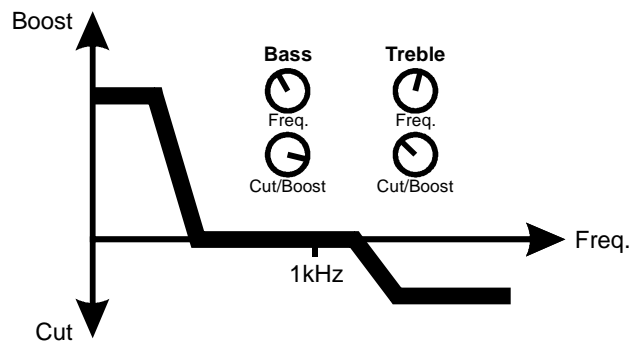

Bass boost and treble cut with crossover close to 1 kHz

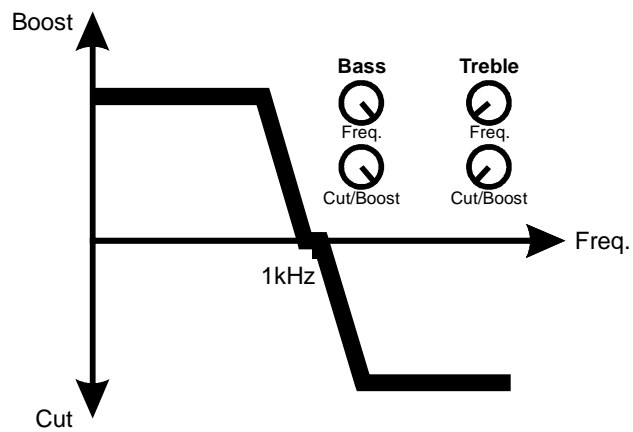

Bass cut and treble boost

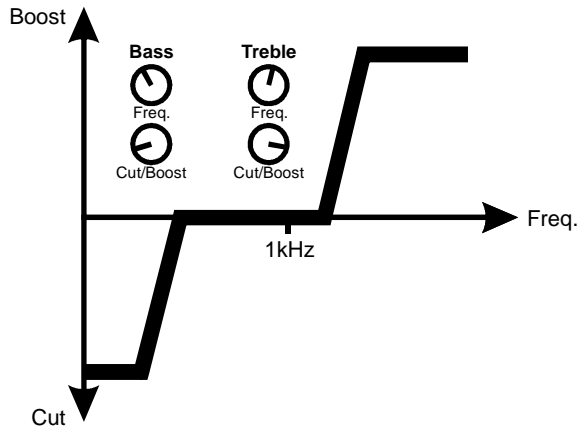

Bass boost and some treble boost

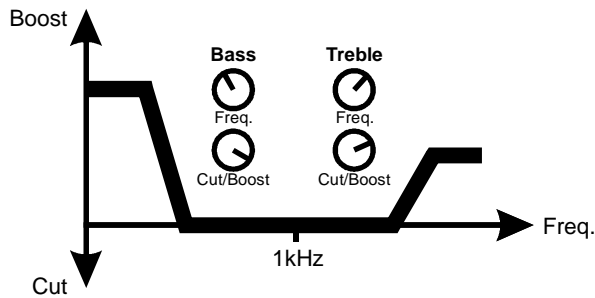

DSP Noise Filter

If your ParaPro unit is fitted with a DSP Noise Filter, you will see a control (bottom left) that allows you to adjust the level of noise filtering.

At the minimum setting, the DSP noise filtering is completely disabled and audio is passed with full bandwidth. Equalisation is still adjustable with the Parametric Equaliser controls. If the DSP Noise Filter control is turned up, the DSP filtering will be enabled and the audio bandwidth optimised for CW and Voice communications. The level of DSP noise filtering is adjustable in 8 steps throughout the control's rotation. Even with the DSP noise filtering enabled, the Parametric Equaliser controls can be adjusted to further improve the listening intelligibility or listening preference.

Increasing level of DSP noise reduction
(with Voice/CW optimised audio bandwidth)

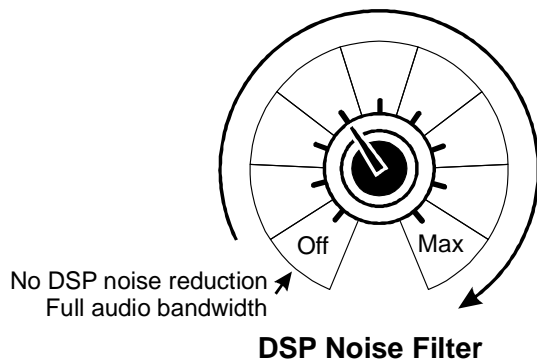

bhi Amplifier Module (Model ParaPro EQ20)

Key Specifications

Power Supply

Voltage range (Vs): 11V to 15V (usually 12V or 13.8V)
Current consumption: <0.2A with no signal.
~1.2A at 13.8V for 10W output (5W per channel into 8 Ohms)
Reverse polarity protected.

Audio Inputs

Line level inputs:

Input impedance: 20k Ohms
Nominal input level: 0.9 Vpk-pk
Overload warning*: 1.2 Vpk-pk
Max input level: 1.6 Vpk-pk

Stereo 3.5mm socket (channel 1 and channel 2)
Mono 3.5mm socket (channel 1)
Mono 3.5mm socket (channel 2)

Bluetooth input:

Bluetooth version: 3.0, Class 2
Nominal range: 10 meters (33 feet)
Frequency band: 2.40-2.48 GHz
RF output power: 4 dBm
RF input sensitivity: -85 dBm (at 0.1% BER)
Broadcast name: "bhi ParaPro xxxx"

*Overload indication: Source selection LED flashes at 4Hz for at least 1.5 seconds

Audio Outputs

Phones out:

Stereo or Mono compatible.
Headphone impedance: 8-32 Ohms.
Headphone output power: 25mW per channel into 32 Ohms.

Speaker out:

Channel 1 and Channel 2
Impedance: > 4 Ohms
Max output: 10 Watts per channel (Vs=15.0V, R=8Ω)
8 Watts per channel (Vs=13.8V, R=8Ω)
6 Watts per channel (Vs=12.0V, R=8Ω)
Outputs via phono (RCA) sockets and 4mm sockets.

Audio controls

Volume: Analogue (digitally read), 64dB adjustment range.
DSP Noise Filter (Optional): 9 levels (including off).
Parametric Filter Type: Two channel, dual cascaded 2nd order Bi-Quad IIR.
Bass Parametric Frequency: 100Hz to 1 kHz
Bass Cut/Boost: -10dB to +10dB
Treble Parametric Frequency: 1 kHz to 10 kHz
Treble Cut/Boost: -10dB to +10dB

Channel select:

Switchable between the following 4 options using a push button:

- A.** Channel 1 to both left and right outputs.
- B.** Channel 2 to both left and right outputs.
- C.** Channel 1 to left output and channel 2 to right output.
- D.** Bluetooth stereo.

Audio Performance

General

Audio resolution: 24 bits Linear PCM per channel
Audio sample rate: 48 kHz (DSP noise cancelling OFF)
16 kHz (DSP noise cancelling ON)

Speaker outputs

Mode: Class-D BTL
PWM rate: 384 kHz \pm 2%
Maximum rated power: 10W per channel sine wave power into 8 Ohms
Total harmonic distortion: 0.13% ($V_s=15.0V$, $P_o=1W$, $f=1$ kHz)
10% ($V_s=15.0V$, $P_o=10W$, $f=1$ kHz)
Signal-to-noise ratio: 90dB
Crosstalk (Ch1/Ch2): -60dB ($V_s=13.8V$, $V_{in}=0.9V_{pk-pk}$, $P_o=1W$, $f=1$ kHz)
Frequency range (to -3dB): 18Hz to 22 kHz (DSP noise cancelling OFF)
300Hz to 5 kHz (DSP noise cancelling ON)

Headphone output

Maximum power: 25mW sine wave power into 32 Ohms
Total harmonic distortion: 0.2% ($P_o=10mW$, $f=1$ kHz)
1% ($P_o=25mW$, $f=1$ kHz)
Signal-to-noise ratio: 90dB
Crosstalk (Ch1/Ch2): -60dB ($V_{in}=0.9V_{pk-pk}$, $P_o=10mW$, $f=1$ kHz)
Frequency range (to -3dB): 18Hz to 22 kHz (DSP noise cancelling OFF)
300Hz to 5 kHz (DSP noise cancelling ON)

bhi support:

Every bhi product comes with a 12 month guarantee against defective materials and workmanship. Please contact us and we will try to resolve any issues as quickly as possible. Please have the following information to hand: 1. The serial number (found on the bottom or rear of the unit). 2. Details of when and where you purchased the unit. See our website www.bhi-ltd.com for FAQs and answers to common questions; otherwise most queries can be resolved over the telephone or via email. **Note:** Opening the case will void any warranty unless agreed beforehand by bhi Ltd. No user serviceable parts inside.

I can hear speech in the speaker when I transmit:

The ParaPro EQ20 has been specifically designed to minimise against the effects of stray RF. If you do hear speech in the speaker on transmit this is probably due to increased levels of RF in your station or an earth loop. Follow best practice and carry out the standard checks necessary to minimise this. 1. Make sure that the audio leads and the fused DC power lead are routed away from sources of electronic interference or RF cables. 2. Try using a separate DC power supply for the EQ20. 3. Reduce the volume on your radio in steps and then increase the volume on the EQ20 to compensate. 4. Fit ferrites to the power cables and audio leads at outlined on the bhi website FAQ page (<http://www.bhi-ltd.com/index.php/support/faq.html>). 5. Check for earth problems and ground loops. Using a separate 12V DC power supply usually solves most issues of RFI breakthrough on transmit. 5. Purchase one of our GroundBreaker audio isolation units. <https://www.bhi-ltd.com/noise-cancelling/accessories/groundbreaker.html>. These small passive units connect to the extension speaker unit of your radio or receiver and the EQ20 plugs into the Ground Breaker unit. It will isolate the audio and remove any ground loops and should reduce the chance of RFI getting in to the audio path.

Important Information:

Copyright

This publication, including all photographs and illustrations is protected under international copyright laws, with all rights reserved. Neither this manual, nor any of the material within, may be copied or reproduced without the written consent of bhi Ltd.

Disclaimer - The information in this document is subject to change without notice. bhi Ltd makes no representations or warranties with respect to the contents hereof and specifically disclaims any implied warranties of merchantability or fitness for any particular purpose. Furthermore, bhi Ltd reserves the right to revise this publication and to make changes from time to time in the content hereof without obligation of bhi Ltd to notify any person of such revision or changes.

Other bhi Products DSP Noise Cancelling Products

Dual In-Line



The bhi **Dual In-Line** module provides two channel, stereo and mono noise cancellation, and is suitable for use on all radios and receivers including SDR. This unit caters for both high and medium level audio input signals, and has stereo line out, stereo headphone and a separate 7 watt amplified mono audio output for use with a mono speaker, making it very flexible for the user. You can listen with headphones and a mono speaker at the same time, and you could also connect a pair of amplified stereo speakers or another pair of headphones to the line output socket, allowing you to monitor two separate channels at the same time, an ideal feature for use in clubs stations, training, DXing, special event stations and field day events.

Compact In-Line



The bhi **Compact In-Line** module is a small handheld battery operated unit ideal for portable use and is designed to be used with a pair of stereo headphones, but will also drive a mono loudspeaker or a pair of powered stereo speakers. It can be powered by two AA alkaline or NiMH batteries, or from a separate DC supply. The module functions are microprocessor controlled and the unit can accept mono or stereo signals. It has separate speaker level and line level inputs controls with pushbutton action for filter level select, power on/off, volume control and stereo/mono signal selection. This compact DSP noise cancelling unit is very easy to use and you can easily adjust the controls to suit the current listening conditions. It is suitable for use on all radios and receivers including software defined radios (SDR).

DESKTOP

The bhi **DESKTOP** DSP noise cancelling base station speaker cleans up noisy radio signals and will work with most radios, transceivers and receivers, including SDR radios and other receivers with stereo line out, giving a new listening experience. The new rotary controls make it easy to use and set up to your own operating conditions. The bhi **DESKTOP** noise cancelling speaker has a 4" bass driver and 1" tweeter, with bhi DSP noise cancelling technology built into a 10 Watt audio amplifier. The speaker functions are microprocessor controlled with features that include: Separate rotary volume and filter level controls via digital rotary encoders, stereo line-in and speaker level audio input sockets, 3.5mm headphone socket, LED and audio indication of filter level and function, audio level overload feature, sleep mode, noise reduction 9 to 35dB, tone reduction 4 to 65 dB, 12 to 18V DC (2.5A peak), weight 1.90Kg, dimensions 200(H) x 150(D) x 160(W)mm.



Weee Statement for correct disposal of this product



(Applicable in the European Union and other European countries with separate collection systems). This marking shown on the product or its literature, indicates that it should not be disposed of with other household wastes at the end of its working life. To prevent possible harm to the environment or human health from uncontrolled waste disposal, please separate this from other types of wastes and recycle it responsibly to promote the sustainable reuse of material resources. Household users should contact either the retailer where they purchased this product, or their local government office, for details of where and how they can take this item for environmentally safe recycling. Business users should contact their supplier and check the terms and conditions of the purchase contract. This product should not be mixed with other commercial wastes for disposal.

bhi Ltd
22 Woolven Close, Burgess Hill
West Sussex, RH15 9RR
England

Telephone: + 44 (0)1444 870333
Email: sales@bhi-ltd.com
Web: www.bhi-ltd.com

Remove the noise and hear the speech!
www.bhi-ltd.com