

Quick assembly guide

Most amateur radios do not have an internal voice memory for transmitting. If you want to use such a convenient feature you can build this simple but effective solution. Its great for contest, QRP, SOTA and holiday operations.

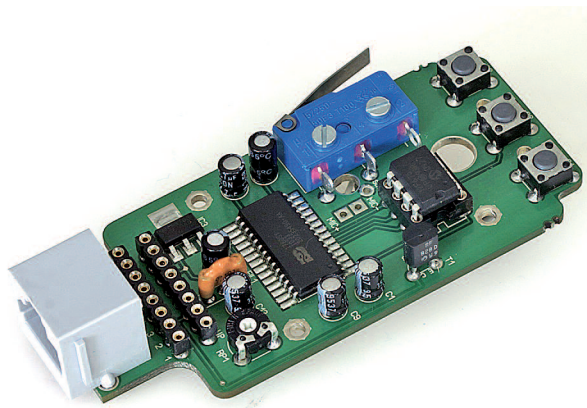

Main features

- Pre-assembled replacement-board for the original PCB of the Yaesu-Microphones MH-31A8j or B8.
- Works with Yaesu-Transceivers (450, 817, 857, 897, 900, 950, 2000), Icom (706xx, 7000), Kenwood and some more.
- Record and playback of a voice message of max. 60 sec. length
- Single playback or repeated playbacks with interrupts (3, 6 or 10 sec. selectable) for monitoring your operating frequency.
- Simple playback cancel by pushing the mics PTT key.

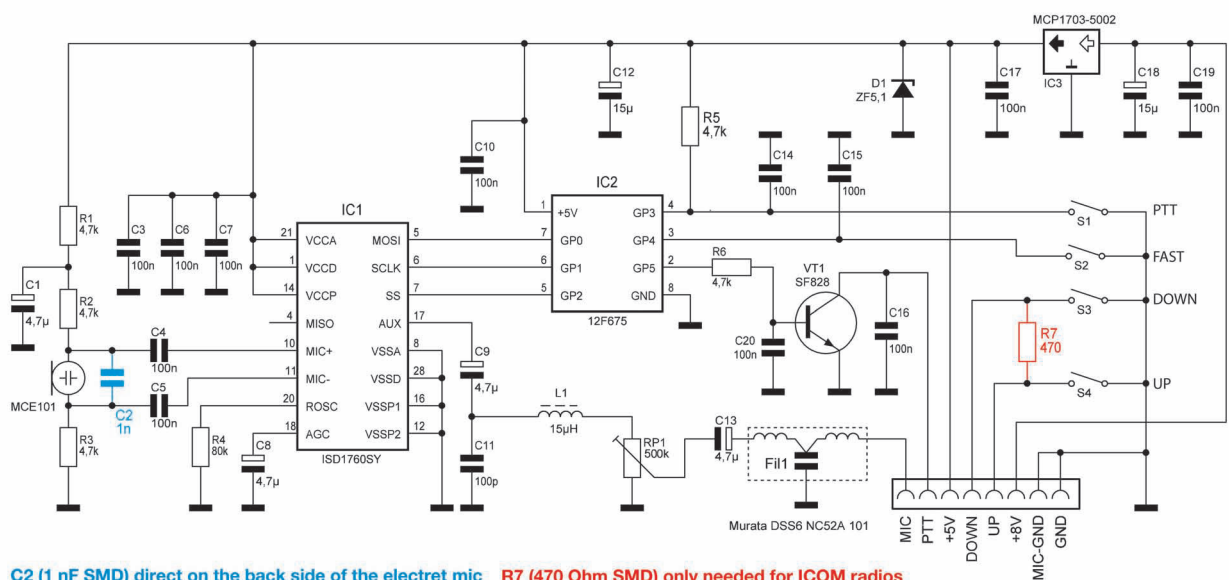

C2 (1 nF SMD) direct on the back side of the electret mic R7 (470 Ohm SMD) only needed for ICOM radios

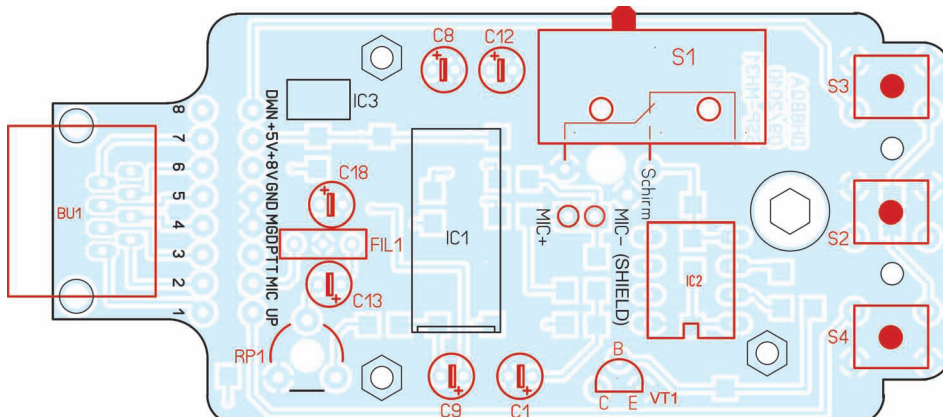

Finalizing the PCB

First you have to solder some thru hole components on upper side of the SMD pre-assembled PCB. See pictures.

3 push switches (S2, S3 and S4):

Install and solder the switches so that they are flat against the board.



2 of 4 directions possible

6 polarized capacitors (4 x 4.7 μ F: C1, C8, C9 and C13, 2 x 15 μ F: C12 and C18)

Install and solder these parts. Be sure to insert the parts in the correct position/orientation. See the small +-symbol on the PCBs silkscreen and figure right. The negative lead is usually marked on the capacitor.

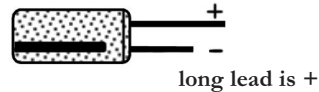

Trimmer RP1:

Install and solder the trimmer. Cut all 3 pins after they are soldered.

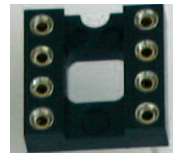

IC socket for IC2 (controller), 8 pin

Pay attention to notch and make sure to have the correct orientation.



Transistor VT1 (SF828, npn):

See silkscreen

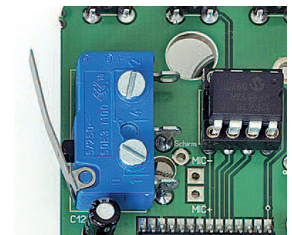
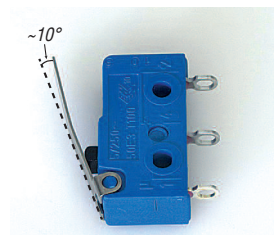

PTT switch (S1):

First bend the metal plate slightly (approx. 10 degrees) as shown at the right figure. Use 2 screws (M2 x 10 mm) and nuts with plastic washers to fix the switch. Solder the 2 contacts with short bare wires with the appropriate pads on the PCB.

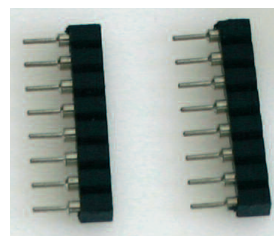

2 sockets (1 x 8 pin, female)

For configuration with wires:
Install and solder these parts.

Note: If you plan to operate the voice keyer with only a single transceiver type you can

solder wires between the pads.

EMI-filter (FIL1):

Either orientation is correct. Install and solder the filter.

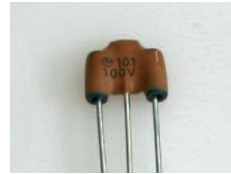

RJ45 jack (BU1):

Install and solder



Optional test

If you have the necessary regulated DC power source you can apply +8 V to the corresponding pins of the mics side 8-pin SIL socket (not the socket near to the RJ45 jack). Pin 1 of the controller socket must have +5V and the total current (without controller) should be near 2,5 mA.

Power option: If your radio has can supply +5 volts and the total current is near 2.5 mA then you can use the +5 volt input pad. (Such as supplied from the FT-817.) Otherwise you can supply +8 to +16 volts to the pad marked +8.

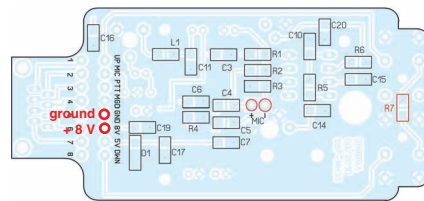

Controller (PIC)

Finally insert the programmed 8-pin PIC in its socket and make sure to have the correct alignment. See the notch!



Configuration according the type of the transceiver

For the proper operation there are some connections needed between the pins of the 2 SIL sockets. It is recommended to use the blank wire (ø 0,5 mm) and short pices of the red flexible insulating tube.

Yaesu transceivers

For the use with FT-817, 857, 897 or 950 there are 7 wire connections needed as shown in left figure.

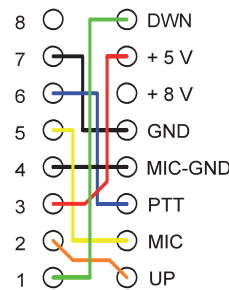

FT-817 857, 897

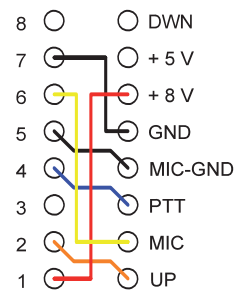

IC-7000, IC-706MKIIG

Icom transceivers

For the use with Icom radios IC-7000 and IC-706xx make connections as shown in the right figure. In addition an extra resistor on the PCB is necessary for Icom transceivers!



SMD resistor in cutted reel

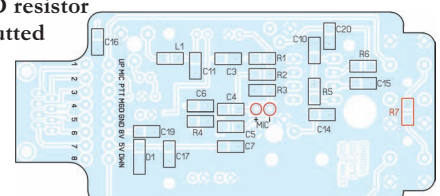

For Icom only resistor, 470 Ohm (R7)

Install and solder this SMD resistor at the bot-

tom side of the PCB.

Installing the new PCB into the original microphone

Remove 3 screws from the rear side of the microphone.



Unscrew 3 screws inside to loosen the original PCB and remove it with the original dynamic microphone.

Pick up the plastic PTT key.

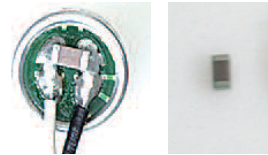

Solder the SMD capacitor C2 (1 nF) direct on the back side of the electret mic. See figure right.

SMD capacitor C2 with no marking



To prevent any electrical shortcut use a 15 mm long red flexible tube (figure right) or trim the both leads of the mic cable to approx. 6 mm.

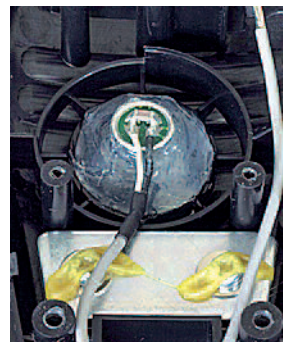

Use a hot glue gun to fix the electret microphone in the centre of the microphone place. Fill the hole completely for the best sound.



Solder both microphone leads with the pads at the upper PCB side. The shield must be connected with „MIC-“ and the inner line with „MIC+“.

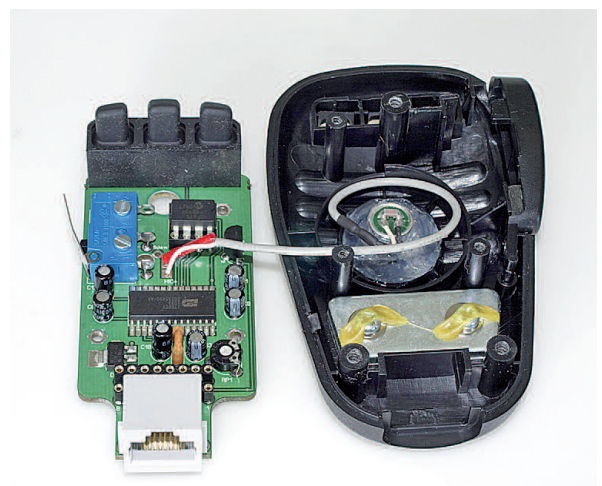
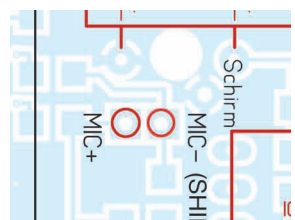
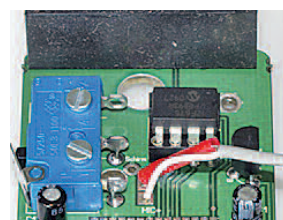

Now insert the new PCB and fix it with the 3 screws and attach the PTT key.

Check the switching operation of the new PTT switch. If needed, correct the angle of the metal plate slightly.

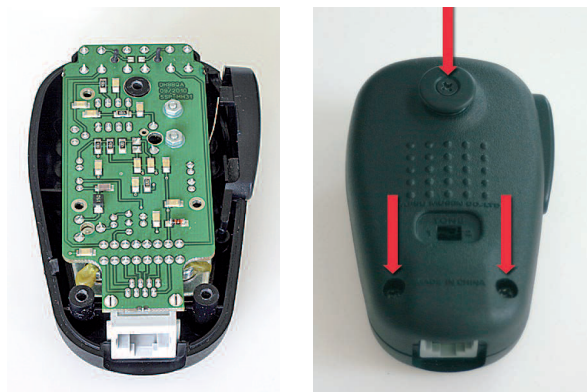

Parts list

Designators	Quantity	Values	Description and notes
PCB	1		pre-assembled
C2	1	1 nF	SMD 1206 (direct on the rear mic pads)*
R7	1	470 ohm	SMD 1206 (only for Icom radios)*
C1, C8, C9, C13	4	4.7 μ F	radial
C12, C18	2	15 μ F	radial
RP1	1	trimmer 500 k	
FIL1	1	EMI filter	
VT1	1	transistor SF828	TO-92, npn
IC2	1	PIC	controller, programmed
IC2	1	IC socket, 8 pin	
Mic	1	electret mic MCE101	with shielded cable
S1	1	PTT switch	
S2-S4	3	switch push button	
Bu1	1	RJ45 jack, 8 pole	
Bu2, Bu3	2	socket, 1 x 8, (female)	
	2	screw M2 x 10	for attaching S1
	2	nut M2	for attaching S1
	2	washer M2 (nylon)	for attaching S1*
		wire, blank, \varnothing 0,5 mm	approx. 15 cm
		flexible tube	approx. 10 cm

* in separate envelope

Return the back cover of the microphone and fix it with the 3 original screws.

Operating the Voice Keyer

All 3 operating modes (record, single playback and loop playback) are controlled by the FST key. In addition there is a simple set mode for selecting the duration of monitoring interrupt.

Record

Push and hold the FST key for 3 seconds (minimum) to enter the record mode. Push and hold the PTT key and speak into the microphone with normal voice level. At the end of your call release the PTT. Your message is now stored .

Single playback

Push the FST key briefly (less than 0.5 sec.). The transceiver transmits your call one time

and switches back to receive.

If desired, press PTT key to cancel the transmission.

Loop playback

Hold down the FST key for 1 second (0.5 to 1 sec.) to start the playback.

Setting the monitoring time for loop playback operation

Pause time for monitoring is set to 3 seconds initially. While holding the PTT key down press FST for 0.5 seconds. This changes pause to 6 seconds. Pressing PTT and FST together again will change from 6 to 10 seconds. Doing it all again will change from 10 back to 3 seconds. Selection works circularly.