

Operating Manual

140-525 Analyst

SWR & Return Loss Meter



135-525 MHz Analyzer



Proprietary Information

© 2000-2010 by AEA Technology, Inc. All rights reserved. This document and all software or firmware designed by AEA Technology, Inc. is copyrighted and may not be copied or altered in any way nor may it be marketed, sold or distributed without the expressed written consent of AEA Technology, Inc. Reproduction, dissemination, or use of information contained herein for purposes other than operation and/or maintenance is prohibited without expressed written authorization from AEA Technology, Inc.

Note: AEA Wireless, Inc. changed its name to AEA Technology, Inc. in 2004. Any reference in this manual, accessories, or other materials belonging to this instrument and stating AEA Wireless now refers to AEA Technology, Inc.

140-525 Analyst is a trademark of AEA Technology, Inc. 2000-2010

SECTION 1	INTRODUCTION	1
	WHAT IT DOES	1
	FEATURES	1
	SPECIFICATIONS	2
SECTION 2	QUICK START	3
SECTION 3	OPERATION	5
	SET-UP	5
	DISPLAY	5
	ICONS	7
	RESETTING THE INSTRUMENT	7
	DEDICATED KEYPAD	8
	MENUS	9
	FREQUENCY SWEEP RANGE	19
	EXAMINING A PLOT	20
	PLOT SCALING	22
SECTION 4	INTERNAL ACCESS	25
	DISPLAY CONTRAST	25
	FUSE REPLACEMENT	25
	BATTERY REPLACEMENT	26
	USING NICAD BATTERIES	26
SECTION 5	OPERATION FROM A TERMINAL	27
SECTION 6	LIMITED WARRANTY	29
SECTION 7	IN CASE OF TROUBLE	31
APPENDIX A:	PARTS PICTORIAL	33
APPENDIX B:	INTERFACE CABLES	35

WARNING: DO NOT leave this highly sensitive instrument connected to an antenna for long periods of time, as nearby lightning strikes can damage it without your knowledge.

SECTION 1 INTRODUCTION

What It Does

The 140-525 Antenna Analyst combines a microprocessor controlled 135-525 MHz frequency synthesizer with an accurate low-power directional coupler to present a graphical display of Return Loss or VSWR versus frequency. To create these graphical displays, the Analyst continuously sweeps and plots the user-selectable frequency range. You can define this frequency “sweep” range as well as take measurements within a plot, using the Analyst’s dedicated keys. More specialized functions are embedded within a system of menus that you can access using the top row of “softkeys”, labeled F1-F-5.

Once installed on your PC, Analyst Director software allows you to remotely control the Analyst, as well as save and print. Director users enjoy increased efficiency and real time data flow.

NOTE: It is possible to remotely control the Analyst from an ASCII terminal, however, data flow is slightly delayed.

Features

- Graphical display of Return Loss or VSWR versus frequency
- Digital readouts of Return Loss and VSWR versus frequency
- Tactile Feedback Keypad
- Auditory cues
- Relative field strength measurements
- Self-tests
- Automatic plot scaling
- Automatic hold and Automatic off
- Non-volatile memory
- Storage for up to 15 plots

Specifications

- Frequency Range 135MHz to 525 MHz
- Default Frequency
Step Size 10KHz
- Frequency Resolution 10KHz increments
- Display Width 0 to 500MHz
- Impedance 50 Ohms
- Antenna Connector .. N Type
- Output Power Appx. +5dBm into 50 Ohms
- VSWR Plotting Range 1:1 to 10:1
- VSWR Accuracy $\pm 10\%$ below 2:1
- Return Loss Range .. -1.73 to -35dB
- Return Loss Accuracy $\pm 0.5\text{dB}$ typical -2 to -10 dB
- Maximum Input +20dBm
- Plot Speed Appx. 2 seconds/sweep
- Memory Non-volatile memory for 15 plots
- PC Interface Serial, 9600 or 19200 baud, XON/XOFF
- Internal Power..... 8 AA Alkaline, NiMH or NiCd cells
(NiMH or NiCd require external charging)
- External Power 12 to 16VDC @ 300mA
- Battery Saver Mode ... Shut down after 5 minute idle period
- Size 4.3" x 2.25" x 8.5" (109 x 57 x 216mm)
- Weight 1 lb. 10 oz. (725g) with batteries

SECTION 2 QUICK START

To help you get started, we have included this brief tutorial which outlines the general functions of the 140-525 Antenna Analyst.

While the Analyst is off, hold down both the F1 and F5 softkeys and press the ON key. Continue holding down the keys until the unit beeps. The Analyst will now operate according to its default settings.

A simple plot will appear on the display. Notice that the center frequency is 250.00 MHz, and the display width is 0.00, indicating that the unit will analyze VSWR and Return Loss at a single frequency (250 MHz). The plot has been given the default name "NEW". The RETL value (0.00) is highlighted, indicating that the unit is plotting Return Loss. The top of the vertical axis is labeled -1.73 dB, and the bottom is labeled -35.00 dB. Since there is no antenna connected to the Analyst, the plot is given an out-of-range value represented by a straight line at the top of the display.

To switch from RETL mode to VSWR mode, press F1 (*Menu*) key. The Main menu will appear onscreen. Press F1 again to access the DSPLY menu, which lists the display modes. Press F2 to select the VSWR display mode. Plotting will immediately resume. Notice that the VSWR value (65.53) is now highlighted, and the vertical axis values have changed to 10:1 at the top and 1:1 at the bottom. Tick marks have also been added at intermediate integer values along the vertical axis.

Now, assume you want to measure VSWR over a 5 MHz frequency sweep range that is centered at 195 MHz. Press 1 9 5 0 0 ENTER to set the center frequency, and then press WIDTH▲ three times to increase the display width to 5 MHz. Touch a small metal object (i.e. paper clip) to the center pin of the antenna connector and let your finger touch the connector's shell. The plot line will immediately drop. You can move the plot up and down by changing your grip on the metal object. Once you have created an "interesting" plot, press the EXAM/PLOT key to freeze the display. A cursor will appear at the center frequency. Use the FREQ keys to move the cursor back-and-forth across the plot. Notice that as you move the cursor, the cursor frequency, VSWR, and Return Loss readings will update.

Before you can save this plot, you must first assign it a recognizable name. In this case, use "BOGUS" as the plot name. Press F1 (*Menu*), F2 (NAME), F1 (ABCDE), F2 (B), F3 (KLMNO), F5 (O), F2 (FGHIJ), F2 (G), F5 (UVWX>), F1 (U), F4 (PQRST), F4 (S), ENTER. Now save the "BOGUS" plot by pressing F1 (*Menu*), F3 (MEM), F2 (STORE), F1 (#1).

For more detailed information on each of these functions, please refer to later sections in the manual.

SECTION 3 OPERATION**Set-Up**

Attach the antenna under test to the antenna connector on the top of the Analyst. Press and hold the ON key until the Analyst beeps.

CAUTION: Do not connect any transmitting equipment directly to the antenna connector. Excessive RF at the antenna connector will damage the Analyst. Use only enough coupling to obtain a reading.

Display

Figure 1 - 140-525 Display

The display's plotting area is 100 pixels per side. It is bordered on the left by a vertical axis representing Return Loss or VSWR values, and on the bottom by a horizontal axis containing tick marks every ten pixels. The center frequency is identified by a missing pixel above the center tick mark (Figure 1). During active plotting, tick marks are added to the vertical axis at integer values of VSWR or 5 dB intervals of Return Loss, depending on the display mode selected (refer to DISPLAY MENU section).

For optimal display resolution, activate the SCALE function (refer to FUNCTION MENU section). With this function enabled, the Analyst quickly scans the current frequency sweep range before plotting any values. It then sets the top of the vertical scale to the highest Return Loss (between -9.5 dB and -1.73 dB) or VSWR value (between 2:1 and 10:1) identified within the range. In Return Loss mode, the Analyst also scans the range for a minimum scale value. Values that exceed the scale's maximum value are plotted along the top line of the display.



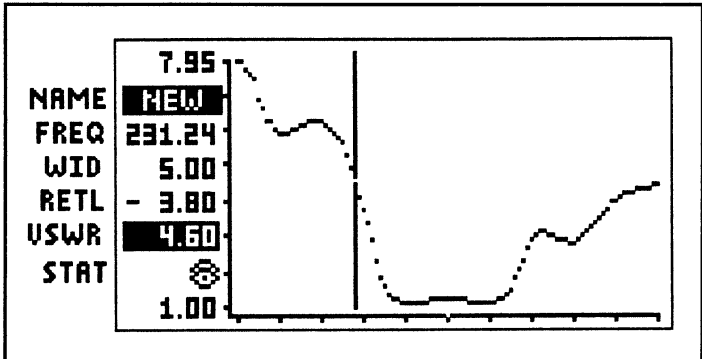





To the left of the vertical axis are eight lines of information. The top line indicates the plot's maximum VSWR or Return Loss value, while the bottom line indicates the minimum VSWR or Return Loss value. The six intermediate lines are identified by the following captions:

NAME	Name of the current plot. If the plot has not yet been assigned a name, the word "NEW" will be displayed on this line.
FREQ	Cursor frequency in MHz. During plotting, the cursor invisibly relocates to the center frequency.
WID	Width of the plot in MHz.
RETL	Return Loss, measured in decibels, at the cursor frequency.
VSWR	Voltage Standing Wave Ratio (VSWR) at the cursor frequency.

STAT Displays up to three icons indicating the current operational status of the Analyst (refer to **ICONS** section); also displays numbers entered on the keypad.

ICONS

The following key lists the eight icons that may appear on the **STAT** line at various times of operation.

-  Appears when external RF energy may be sufficiently high to cause inaccurate readings.
-  Indicates that the batteries are getting low and should be replaced (or recharged) soon. *NOTE: For a more exact battery reading, refer to the MISCELLANEOUS MENU section.*
-  Indicates that the limit alarm value was exceeded somewhere in the current plot. If the **ALARM** function is enabled, a low-pitched beep will also sound at the plot's completion.
-  Appears while the Analyst is scanning the frequency sweep range for scale value(s).
-  Indicates that a plot memory download from a PC is in progress.
-  Indicates that a plot memory upload, or a display dump, to a PC is in progress.
-  Indicates that the Analyst is in the **EXAM** mode.
-  Indicates that the synthesizer has lost phase-lock. *NOTE: This icon may flash briefly during operation, however, if it stays on longer, service*

may be required.

RESETTING THE INSTRUMENT

The current display settings (i.e. display mode, center frequency, display width, frequency step size, and limit alarm value) are saved when the Analyst is turned off. To reset the Analyst to its default settings, hold down the F1 and F5 softkeys while turning the Analyst on. Continue holding down the keys until the Analyst beeps. Note that resetting the Analyst to its default settings clears all 15 plot memories!

DEDICATED KEYPAD

As mentioned in the Introduction, the Analyst's keypad contains two types of keys. The dedicated keys, which include all but the top row of the keypad, control the most frequently used functions.

The ON and OFF keys activate and deactivate, respectively, the Analyst.

The number keypad is primarily used to enter a new center frequency, display width, and frequency step size values. As you enter each number, it will appear on the STAT line, which can accommodate up to five numbers. If you make a mistake while entering a number, simply start over. Newly entered numbers will shift left and replace older entries.

The center frequency value, which determines the midpoint of the frequency sweep range, can be adjusted in two ways. You can either enter a new value on the number keypad followed by the ENTER key, or you can use the FREQ keys to increase or decrease the center frequency by a given step size.

The default step size value is 10 kHz, however, you can change this default to any value between 0 and 250 MHz. Simply enter a value on the number keypad, followed by the appropriate FREQ key.

The display width value, which determines the length of the frequency sweep range, can be adjusted between 0 and 500 MHz. Use the WIDTH keys to step through these values in a 1-2-5 sequence, or enter a specific integer value on the keypad, followed by either WIDTH key. Note that you do not need to enter trailing zeros to identify a display width value as an integer. For example, to select a display width of 75 MHz, simply enter 7 5 WIDTH▲. Although this value will appear as “.75” on the STAT line, the Analyst will recognize it as an integer since the two least-significant digits are not zeros.

The EXAM/PLOT key allows you to toggle between the EXAM mode and the active plotting mode. In the EXAM mode, the current plot is frozen so that you can take measurements within a plot without the plot values constantly fluctuating (refer to EXAMINING A PLOT section).

To clear a plot before it has been completed, press the ENTER key. The Analyst will clear the display and begin a new plot. If the SCALE function is enabled, the Analyst will also rescale the plot at this time.

MENUS

Unlike the dedicated keys, the F1-F5 softkeys do not perform just one function, but allow you to access many features through the use of menus. These menus appear at the bottom of the display whenever

you press one of the softkeys. Each menu contains five subdivisions that correspond to the five softkeys. Simply press the softkey located directly below a subdivision to select that function. Often, you may have to make selections from two or three different menus to activate a desired function. In most cases, after you have made your final selection, the menu will disappear and the bottom section of the current plot will reappear. In a few cases, you must press ENTER to exit a menu.

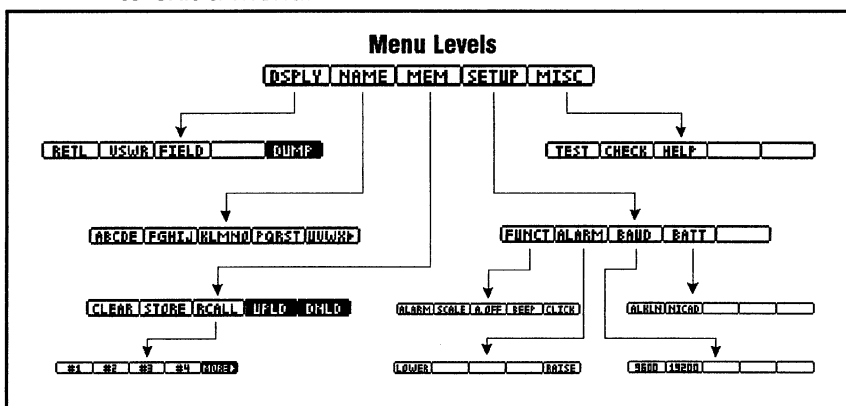

Figure 2 - Menu Levels

MAIN MENU

DSPLY NAME MEM SETUP MISC

The F1 softkey is labeled *Menu* to remind you that pressing it (or any of the softkeys) will display the Main menu.

DISPLAY MENU

RETL USWR FIELD DUMP

Select DSPLY (F1) from the Main menu to select either Return Loss (RETL) mode or VSWR mode. Although both VSWR and Return Loss values are

displayed digitally during plotting, the plot itself represents only one mode at a time. Notice that only the selected mode's corresponding value is highlighted. The current display mode is saved when the Analyst is powered off.

Default: Return Loss

The DSPLY menu also contains the FIELD function, which allows you to activate the relative field strength mode. This function allows you to check a transmitter for output, etc. If the BEEP function is enabled, a beeping tone, which increases in pitch as field strength increases, will sound until full scale is reached. To exit the field strength mode, press ENTER.

*NOTE: **Do not** connect any transmitting equipment directly to the antenna connector. Excessive RF at the antenna connector will damage the Analyst. Use only enough coupling to obtain a reading. As a reminder, the word "CAUTION!" will flash on the display while you are in this mode.*

The DSPLY menu also contains a DUMP function which transfers the current plot (through the serial port) to your PC screen. (The included Analyst Director software accesses this function automatically.)

NAME MENU

ABCDEF GHIJKL MNOPQRST UVWXYZ

Before you can save a plot, you should assign it a name. To do this, select NAME (F2) from the Main

menu. A new menu containing groups of letters will appear onscreen. To access one of the groups, simply press its corresponding softkey. Each letter will then appear individually.

For example, if you press F1 to access the first group of letters, the following menu will appear:

A **B** **C** **D** **E**

To access the last few letters of the alphabet not visible in any of the groups, press F5 (UVWX>).

U **V** **W** **X** **MORE>**

Press the F5 softkey (MORE>) to display the letters Y and Z, a hyphen, a period, and <DEL. Use <DEL to delete the last character entered.

Y **Z** **-** **.** **DEL**

Any letters and/or punctuation marks you select will appear on the NAME line. Plot names can contain up to five characters. After you have selected an individual letter or punctuation mark, the groups of letters will reappear and the process begins again. Once you have finished entering a name, press ENTER.

NOTE: Names may contain numbers as well as letters. To enter a number, simply press a number key when the groups of letters are displayed.

NOTE: Using more than one of the wider letters (G, M, N, Q, W) may cause the name to be truncated to fit on the NAME line.

MEMORY MENU

CLEAR STORE RCALL UP/DN D/LD

Choose MEM (F3) from the Main menu to save new plots, recall old plots, or clear any of the 15 plot memories. Plot memories are initially assigned numerical default names (“#1” through “#15”). However, once you save a plot to one of the memories, the name you have assigned the plot will replace the numerical default name.

When you choose CLEAR, STORE, or RCALL, the name of the selected operation will appear on the STAT line, and the first four plot memories will be displayed:

#1 #2 #3 #4 MORE>

Use the MORE> softkey to scroll through the plot memories. If you decide you do not want to perform the selected operation, press ENTER to exit the menu.

After selecting the CLEAR function, press the softkey that corresponds to the plot memory you wish to clear. The plot memory's numerical default name will be

immediately reinstated and you can save a new plot in that location.

Two built-in safety features prevent accidental plot clearing or overwriting. The first safety feature is a prompt box that appears after you have designated the plot memory you wish to clear. This box displays the name of the selected plot and prompts you to press the F5 softkey if you are certain you want to clear the plot from memory. The second safety feature makes it impossible to save a new plot in an occupied plot memory without clearing it first.

Before you can save a plot using the STORE function, you must assign it a recognizable name (refer to the NAME MENU section). After doing so, return to this menu and select an available plot memory in which to store the plot.

NOTE: To rename a saved plot, recall it to the display, clear plot memory you recalled it from, enter new name, resave.

After selecting the RCALL function, press the softkey that corresponds to the plot you wish to recall to the display. The Analyst will automatically enter the EXAM mode. The plot, its name, display mode, center frequency, display width, and scale factor (vertical axis values) are then recalled to the display. (In effect, plot memories double as “settings” memories.) Press the EXAM/PLOT key to resume plotting according to the recalled settings. If you

attempt to recall a vacant plot memory, the Analyst will sound an error beep and then wait for you to make a new selection.

The MEM menu also contains UPLD (upload) and DNLD (download) functions. The UPLD function allows you to save the entire plot memory (all 15 plots and their settings) to a PC file, while the DNLD function allows you to transfer a plot memory from a PC file to the Analyst. (These functions are accessed automatically by the included Analyst Director software.)

NOTE: When you download a plot memory to the Analyst, all plots that previously resided in the analyst's memory will be overwritten. To save these plots, use the UPLD function to archive them on you PC before downloading a new plot memory.

SETUP MENU

FUNCT ALARM BAUD BATT

Choose SETUP (F4) from the Main menu to access FUNCT, ALARM, BAUD, and BATT functions. Selections made in this menu are universally applied to each plot and are saved when the Analyst is turned off.

Function Menu

ALARM SCALE A.OFF BEEP CLICK

Select **FUNCT** to activate or deactivate the following functions: **ALARM**, **SCALE**, **A. OFF**, **BEEP**, and **CLICK**. When you select one of these functions, its current operational state will appear in parenthesis on the **STAT** line and a new menu containing **ON** and **OFF** options will appear. To switch a function on or off, press the appropriate softkey, or exit the menu by pressing **ENTER**. Either selection will return you to the **FUNCT** menu where you can make a new selection, or exit the menu by pressing **ENTER**.

When a **VSWR** or **Return Loss** value (depending the mode selected) exceeds the limit alarm value anywhere in an active plot, the Bell icon will appear on the **STAT** line at the plot's completion. If the **ALARM** function is on, a low-pitched beep will sound as well.

Default: Off

When the **SCALE** function is activated, the Analyst quickly scans the current frequency sweep range before plotting any values. It then sets the top of the vertical axis to the highest **VSWR** or **Return Loss** value identified within the range (refer to **Plot Scaling** section). In **Return Loss** mode, the Analyst will also scan the range for a minimum scale value. While the Analyst is scanning the frequency range, the Hourglass icon is displayed on the **STAT** line to indicate that you should wait before making further selections. This pre-scanning process allows the Analyst to scale the plot for maximum resolution.

When the SCALE function is off, the vertical axis is fixed at -1.73 (maximum) and -35 dB (minimum) in Return Loss mode and 10:1 (maximum) in VSWR mode.

Default: On

If the A. OFF (Automatic Off) function is activated, the Analyst will turn itself off after a five minute idle period in which no keys have been pressed. If this function is off, the Analyst will enter the EXAM mode after a five minute idle period. This mode reduces battery drain since it causes much of the circuitry to power down.

Default: On

NOTE: If you are using the Analyst Director software to control the Analyst, the A. OFF function will be temporarily disabled to ensure that communication (data flow) between the PC and the Analyst is continuous.

If the BEEP function is activated, the Analyst will beep at a frequency that is proportional to the VSWR when the display width is set to 0 and the Return Loss is lower than -1.73 dB (or the VSWR is lower than 10:1). This auditory cue allows you to make antenna adjustments without having to visually consult the display. This function also enables the beep in field

strength mode.

Default: On

When the CLICK function is activated, an audible click sounds each time you press a key, move the cursor, or adjust the limit alarm value.

Default: On

Alarm Menu

LOWER **RAISE**

The ALARM menu allows you to adjust the limit alarm value, which determines the Return Loss or VSWR value at which the ALARM function will activate. This function is primarily used to determine if a specific value has been exceeded anywhere in a plot. When you select this function, the current limit alarm value, which varies depending on the display mode selected, will appear on the STAT line. To change the limit alarm value, use the LOWER and RAISE softkeys to step through the 128 values ranging between (approximately) -20 dB and -4.4 dB in Return Loss mode (1.22:1 and 4:1 in VSWR mode). When you change the display mode, the limit alarm value automatically converts to the new mode.

Default: -9.54 dB Return Loss/2:1 VSWR

Baud Rate Menu

9600	19200			
------	-------	--	--	--

The BAUD menu allows you to select either 9600 or 19200 baud for serial I/O. If you have a slow PC or loaded TSR's, or you are running software from a DOS window, it may necessary to use the slower baud rate.

Default: 19200

Battery Menu

ALKLN	NI CAD			
-------	--------	--	--	--

The BATT menu allows you to specify the type of batteries – Alkaline or NiCd – powering the Analyst. If you choose to use NiMH cells select NICAD. If the selection made here does not reflect the type of batteries actually in use, the Analyst will not report battery status accurately. If NiCd or NiMH cells are used they must be removed and recharged in an external battery charger.

Default: Alkaline

MISCELLANEOUS MENU

TEST	CHECK	HELP		
------	-------	------	--	--

Choose MISC (F5) from the Main menu to access functions that determine if you Analyst is operating at an optimal level.

Select the TEST function to run self-diagnostics on the

Analyst's display, program ROM, synthesizer, serial port, and non-volatile memory. The results of these self-diagnostics, along with the firmware version number, are displayed onscreen. After viewing the test results, press ENTER.

NOTE: In order for the serial port to pass the self-diagnostic test, you must first insert a 3.5 mm plug into the serial connector, with Tip shorted to Ring. If you do not insert the plug, simply ignore the "BAD" test result.

The CHECK function displays three bargraphs labeled POWER, VCO, and BRIDGE. The POWER bargraph indicates general battery status. For a more exact battery reading, refer to the upper left corner of the display. The VCO bargraph indicates the tune voltage at the low (L) and high (H) ends of the frequency range. The BRIDGE bargraph indicates the forward and reflected voltages from the directional coupler. Note that the thicker sections of the bars represent normal operating areas. Press ENTER to exit this display.

The HELP function accesses an index of onscreen help pages covering virtually every aspect of operation. The page that appears when you first press the HELP softkey explains how to use this function efficiently. To exit HELP, press ENTER one to three times depending on how far you are advanced in the system.

FREQUENCY SWEEP RANGE

During normal operation, the Analyzer continuously sweeps and plots a user-selected frequency range. This range, termed the frequency sweep range, is defined by the center frequency and display width values.

Each tick mark on the horizontal axis represents an interval equal to the display width value. When the display width is set to 100 kHz, for example, each tick mark represents an interval of 100 kHz. Thus, the total frequency sweep range represented within the plot is 1000 kHz, or the sum of all ten intervals. This can be simplified as: Frequency Sweep Range = 10 x Display Width.

Now assume that the center frequency value, which determines the midpoint of this 1000 kHz frequency sweep range, is set to 200 MHz. Divide the total frequency sweep range (1000 kHz) by two (500 kHz) to determine the minimum and maximum sweep values. Subtract 0.500 from 200 MHz to determine the minimum value, and add 0.500 to 200 MHz to determine the maximum value. The frequency sweep range in this example is 199.5 MHz to 200.5 MHz.

When the Analyst is first activated, the center frequency defaults to 250 MHz and the display width defaults to 0 kHz. Maintain the default display width value to analyze VSWR and Return Loss at a single frequency (center frequency value).

EXAMINING A PLOT

During active plotting, the cursor frequency, Return Loss, and VSWR values displayed to the left of the vertical axis, correspond to the center frequency.

To take measurements at other points in the plot, press EXAM/PLOT to enter the EXAM mode (refer to DEDICATED KEYS section). A cursor will appear, superimposed on the plot at the center frequency. Use the **FREQ▲** and **FREQ▼** keys to move the cursor right and left, respectively. (Hold down the desired FREQ key to move the cursor at an accelerated rate.) The cursor frequency, Return Loss, and VSWR values will update as you move the cursor across the plot. Press EXAM/PLOT a second time to resume plotting with the current cursor frequency as the plot's new center frequency. To revert to the original center frequency value, simply press ENTER before pressing EXAM/PLOT the second time.

If the plot you are examining was somehow cut off before it was completed, the Analyst will not display Return Loss and VSWR values beyond the cut off point.

NOTE: Since much of the Analyst's circuitry is powered down in the EXAM mode, it is advisable to enter this mode whenever possible to extend battery life. Or, simply turn the Analyst off when you are not plotting

REGARDING SAVED PLOTS

If you attempt to examine any Return Loss or VSWR values that exceed a saved plot's maximum value, the Analyst will display the message "!OVER!". This is due to the fact that the Analyst does not save the actual values at each point, but rather the positions of each point on the display. For the same reason, VSWR and Return Loss values displayed in the EXAM mode may differ slightly from those displayed during active plotting.

NOTE: For best results, save plots with the SCALE function enabled. This ensures accurate readings of Return Loss and VSWR values when you recall the plot for examination.

PLOT SCALING

For optimal display resolution, activate the SCALE function (refer to FUNCTION MENU section). With this function enabled, the Analyst will scan the current frequency range before plotting any values. Then, depending on the display mode selected, the Analyst will set the vertical scale's maximum value to the highest VSWR (between 2:1 and 10:1) or Return Loss value (between -9.5 dB and -1.73 dB*) identified within the range. Values that exceed the scale's maximum value are plotted on the top line of the display. Plots containing a series of out-of-range values will exhibit a solid line across the top of the display.

SECTION 4 **INTERNAL ACCESS**

When the Analyst's rear cover is removed, a number of trimmer resistors and capacitors are exposed. Since your Analyst was carefully aligned at the factory for optimal performance, it is recommended that you make no adjustments other than to the display contrast, described below.

There are six screws on the rear cover. Remove the two screws behind the rubber foot to access the battery compartment. When replacing the battery cover, make sure the foot's pegs are securely positioned in the slots in the top of the battery cover before reinstalling the screws.

Remove the four screws in the corners of the rear cover to access the circuit board, which contains the controls referred to in the following section. (You do not need to remove the battery cover screws when accessing the circuit board.) After removing the four corner screws, hold the front cover in one hand and carefully flip the rear cover to the other hand to avoid stressing the battery connection wires. When you remove the rear cover, make sure the connector panel remains positioned in the front cover.

DISPLAY CONTRAST

Use the R11 potentiometer, located at the bottom of the circuit board, to adjust the display contrast.

FUSE REPLACEMENT

To protect the Analyst from potential damage, the fuse

Section 4 – Internal Access

will blow if an external power supply is connected with the wrong polarity. If the happens, replace the fuse with a 250mA, slow-blow type.

BATTERY REPLACEMENT

Confirm that the Analyst is off before replacing the batteries. To avoid damaging the Analyst, be sure to insert the batteries according to the markings located on the inside wall of the battery compartment. If alkaline batteries are replaced with NiCd batteries, or vise-versa, be sure to select the proper battery type in the BATT menu (refer to BATTERY MENU section).

USING NICD, NIMH, or ALKALINE BATTERIES

NiCd or NiMH batteries can be used to power the 140-525 Analyzer. However, they must be removed for recharging in an external recharger designed for those type cells. The chart below shows the approximate operating time for each type of battery used. Also refer to AEA Technology’s application note “AN150 Using Batteries in AEA Technology Instruments” for more information on each battery type.

Typical Operating Times by Battery Type:

Alkaline 3500 maHr	NiCd 2000 maHr	NiMH 2000 maHr
11 Hrs	6 Hrs	6 Hrs

SECTION 5 **OPERATION FROM A TERMINAL**

You can control all of the Analyst's functions (except power on) from a terminal or a computer running a terminal emulator program. The terminal's baud rate must be set to the Analyst's baud rate (either 9600 or 19200). It should also be set for no parity, eight data bits, and one stop bit. The keyboard functions are listed below:

- 0-9 Function is same as number keys on Analyst
- A-E Access softkeys F1 through F5
- R Raises the center frequency (same as **FREQ▲**)
- L Lowers the center frequency (same as **FREQ▼**)
- W Widens the plot (same as **WIDTH▲**)
- N Narrows the plot (same as **WIDTH▼**)
- Enter Functions is same as ENTER key on Analyst
- Spacebar . Toggles EXAM/PLOT modes
- ! Turns the Analyst off

Section 6 Limited Warranty

AEA Technology, Inc., warrants to the original purchaser that the 140-525 Analyst shall be free from defects in material or workmanship for a period of one year from the date of shipment. All units returned to the factory, delivery charges prepaid, and deemed defective under this warranty, will be replaced or repaired at this company's option. No other warranties are implied, nor will responsibility for operation of this instrument be assumed by AEA Technology, Inc.

There are no warranties that extend beyond express warranties stated herein. No other warranties are express or implied. AEA TECHNOLOGY SPECIFICALLY DISCLAIMS ALL IMPLIED WARRANTIES, INCLUDING THE IMPLIED WARRANTIES OF MERCHANTABILITY AND FITNESS FOR A PARTICULAR PURPOSE. THE REMEDIES PROVIDED HEREIN ARE BUYER'S SOLE AND EXCLUSIVE REMEDIES. AEA TECHNOLOGY SHALL NOT BE LIABLE FOR ANY DIRECT, INDIRECT, SPECIAL, INCIDENTAL, OR CONSEQUENTIAL DAMAGES, WHETHER BASED ON CONTRACT, TORT, OR ANY OTHER LEGAL THEORY.

Remedies for any breach of warranty, either express or implied, are limited to repair, replacement, or return of the instrument, at the option of AEA Technology, Inc. Any warranty is valid for the original purchaser only.

All warranties of performance are disclaimed.

AEA Technology assumes no liability for applications assistance or customer product design.

SECTION 7 Troubleshooting Guide

Symptom	Possible Causes	Solutions
Dim or no display	<ol style="list-style-type: none">1. Low batteries2. Corroded battery contacts3. Contrast loss	<ol style="list-style-type: none">1. Replace/recharge the batteries or use external AC adapter.2. Clean battery contacts.3. Adjust R11 on PCB to recover normal contrast.
Does not operate with AC Adapter	<ol style="list-style-type: none">1. Incorrect adapter2. AC wall power is off3. Blown fuse	<ol style="list-style-type: none">1. Check that adapter is AEA Technology P/N 5001-0202, or a 12-16 VDC center positive type.2. Check if wall outlet is powered – GFI or wall switch off are common causes.3. Check and/or replace F1 on the PCB.

140-525 Analyst Troubleshooting Guide (continued)

Symptom	Possible Causes	Solutions
Readings remain flat with antenna connected	<ol style="list-style-type: none">1. Loose or broken N connector on antenna cable.2. Damaged N connector center pin3. Detector failure due to overpowering input.	<ol style="list-style-type: none">1. Tighten the N connector to the Analyst's N connector or check for broken cable connection.2. Check instrument's N connector center pin for damage.3. Contact AEA Technology for RMA.
Keypad will not enter data	<ol style="list-style-type: none">1. Loose keypad connector.2. Keypad failure.	<ol style="list-style-type: none">1. Remove and re-insert flex cable into PCB connector.2. Contact AEA Technology for replacement or RMA.
PC communications failure	<ol style="list-style-type: none">1. Serial cable not seated.2. Baud rate mismatch	<ol style="list-style-type: none">1. Check serial cable connections.2. Ensure Baud rate in PC and instrument match.

140-525 Analyst Troubleshooting Guide (continued)

Opening the 140-525 Analyst

1. Turn the instrument off and remove external AC power.
2. Place the instrument face down on a clean padded surface.
3. To check or replace the batteries remove the two screws located under the bail at the base of the battery compartment.
4. To adjust R11 or the keypad flex cable remove the four screws at the corners of the instrument's back case.
5. Hold the top connector plate in place with case front and gently rock the back case side to side to loosen and remove.
6. Place the back case down beside the front case, but do not remove the power cable connected to the PCB.
7. If required, and with power off, remove and fully re-insert the keypad flex cable.
8. If required, re-power the instrument and turn it on to adjust R11 for improved contrast.
9. To close the case align the back case top with the connector panel and lower the back carefully over the front case ensuring not to pinch an cables.
10. Re-insert the four case screws firmly, but do NOT OVERTIGHTEN.

If you need troubleshooting assistance or an RMA number to return the instrument for repair or calibration, please contact us:

Tel: 1-800-258-7805 or +1-760-931-8979, Fax: +1-760-931-8969

Email: techsupport@aeatechnology.com,

Web: www.aeatechnology.com

Address: AEA Technology, Inc.
5933 Sea Lion Pl, Ste 112
Carlsbad, CA 92010

APPENDIX A PARTS PICTORIAL

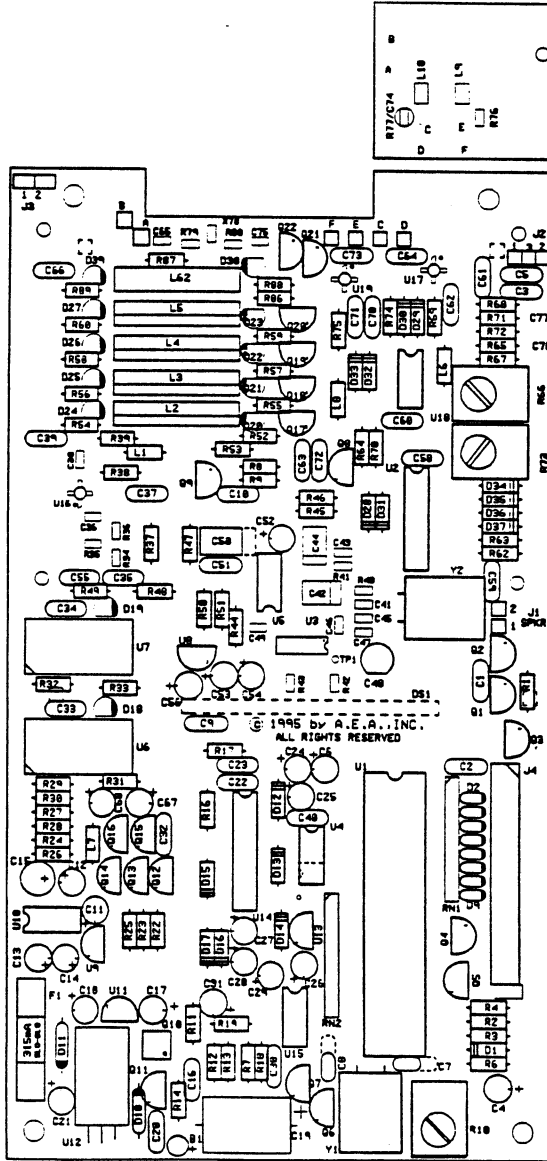

APPENDIX B INTERFACE CABLES

Female 9-Pin Sub-D

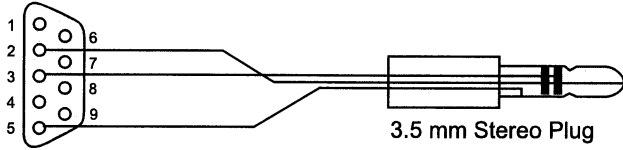

Female 25-Pin Sub-D

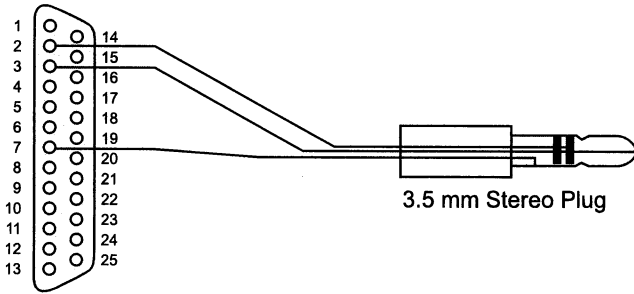



AEA Technology, Inc.

5933 Sea Lion Pl, Ste 112, Carlsbad, CA 92010
Tel: 1-800-258-7805 or +1-760-931-8979, Fax +1-760-931-8969

www.aeatechnology.com