

TRANSISTOR - DIODE TESTER KIT

MODEL DT-100K



Assembly and Instruction Manual

ELENCO®

DT-100 PARTS LIST

If you are a student, and any parts are missing or damaged, please see instructor or bookstore.

If you purchased this transistor–diode tester kit from a distributor, catalog, etc., please contact ELENCO® (address/phone/e-mail is at the back of this manual) for additional assistance, if needed. **DO NOT** contact your place of purchase as they will not be able to help you.

RESISTORS

| Qty. | Symbol | Value | Color Code | Part # |
|----------------------------|---------|---------------|---------------------------|--------|
| <input type="checkbox"/> 1 | R14 | 100Ω 5% 1/4W | brown-black-brown-gold | 131000 |
| <input type="checkbox"/> 2 | R5, R6 | 220Ω 5% 1/4W | red-red-brown-gold | 132200 |
| <input type="checkbox"/> 2 | R1, R10 | 330Ω 5% 1/4W | orange-orange-brown-gold | 133300 |
| <input type="checkbox"/> 1 | R13 | 1kΩ 5% 1/4W | brown-black-red-gold | 141000 |
| <input type="checkbox"/> 1 | R7 | 5.6kΩ 5% 1/4W | green-blue-red-gold | 145600 |
| <input type="checkbox"/> 1 | R12 | 10kΩ 5% 1/4W | brown-black-orange-gold | 151000 |
| <input type="checkbox"/> 1 | R8 | 18kΩ 5% 1/4W | brown-gray-orange-gold | 151800 |
| <input type="checkbox"/> 2 | R2, R3 | 33kΩ 5% 1/4W | orange-orange-orange-gold | 153300 |
| <input type="checkbox"/> 1 | R9 | 47kΩ 5% 1/4W | yellow-violet-orange-gold | 154700 |
| <input type="checkbox"/> 1 | R11 | 100kΩ 5% 1/4W | brown-black-yellow-gold | 161000 |
| <input type="checkbox"/> 1 | R4 | 330kΩ 5% 1/4W | orange-orange-yellow-gold | 163300 |
| <input type="checkbox"/> 1 | R15 | 100kΩ 5% 1/4W | Potentiometer | 192611 |

CAPACITORS

| Qty. | Symbol | Value | Description | Part # |
|----------------------------|------------|--------------|--------------|--------|
| <input type="checkbox"/> 1 | C6 | .001μF (102) | Discap | 231036 |
| <input type="checkbox"/> 3 | C2, C3, C5 | .01μF (103) | Discap | 241031 |
| <input type="checkbox"/> 2 | C1, C4 | 10μF | Electrolytic | 271045 |

SEMICONDUCTORS

| Qty. | Symbol | Value | Description | Part # |
|----------------------------|--------|---------|----------------------------|--------|
| <input type="checkbox"/> 1 | D1 | 1N4001 | Diode | 314001 |
| <input type="checkbox"/> 1 | Q5 | MPS A70 | Transistor | 320070 |
| <input type="checkbox"/> 4 | Q1-Q4 | 2N3904 | Transistor | 323904 |
| <input type="checkbox"/> 1 | IC1 | 555 | Integrated circuit (IC) | 330555 |
| <input type="checkbox"/> 5 | L1-L5 | | Light emitting diode (LED) | 350002 |

MISCELLANEOUS



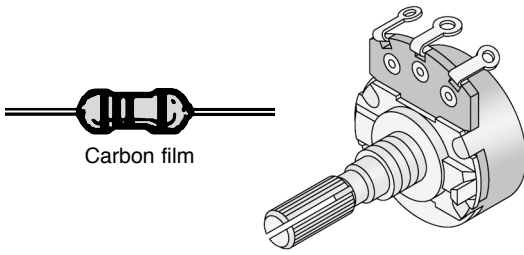
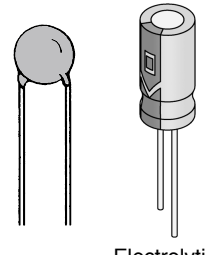
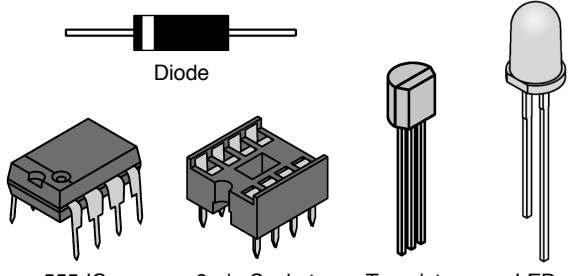

| Qty. | Description | Part # | Qty. | Description | Part # |
|----------------------------|--|--------|-----------------------------|-----------------------|--------|
| <input type="checkbox"/> 1 | PC board | 511100 | <input type="checkbox"/> 4 | Rubber feet | 662015 |
| <input type="checkbox"/> 1 | Switch push button with 1/4" nut and washer | 540001 | <input type="checkbox"/> 1 | Socket 8-Pin IC | 664008 |
| <input type="checkbox"/> 2 | Switch DPDT | 541111 | <input type="checkbox"/> 1 | Transistor socket | 664500 |
| <input type="checkbox"/> 1 | Battery snap | 590098 | <input type="checkbox"/> 1 | Alligator clip black | 680001 |
| <input type="checkbox"/> 1 | Battery clip | 590099 | <input type="checkbox"/> 1 | Alligator clip red | 680002 |
| <input type="checkbox"/> 1 | Knob | 622009 | <input type="checkbox"/> 1 | Alligator clip green | 680003 |
| <input type="checkbox"/> 1 | Case top | 623061 | <input type="checkbox"/> 1 | Alligator clip yellow | 680004 |
| <input type="checkbox"/> 1 | Case bottom | 623062 | <input type="checkbox"/> 1 | Label top panel | 723070 |
| <input type="checkbox"/> 5 | Spacer LED | 624111 | <input type="checkbox"/> 4" | Double-sided tape | 740020 |
| <input type="checkbox"/> 4 | Screw M3 x 0.5 x 5mm | 640300 | <input type="checkbox"/> 1 | Wire black 15" | 813110 |
| <input type="checkbox"/> 4 | Screw 2.8 x 8mm | 641102 | <input type="checkbox"/> 1 | Wire red 15" | 813210 |
| <input type="checkbox"/> 1 | 7mm Hex pot nut | 644101 | <input type="checkbox"/> 1 | Wire yellow 15" | 813410 |
| <input type="checkbox"/> 1 | 8mm x 14mm Washer | 645101 | <input type="checkbox"/> 1 | Wire green 15" | 813510 |
| <input type="checkbox"/> 1 | Lockwasher 5/16" | 646101 | <input type="checkbox"/> 1 | Wire blue 3" | 814620 |
| | | | <input type="checkbox"/> 1 | Solder tube lead-free | 9LF99 |

PARTS VERIFICATION

Before beginning the assembly process, familiarize yourself with the components and this instruction book. Verify that all of the parts are present. This is best done by checking off the parts in the parts list.

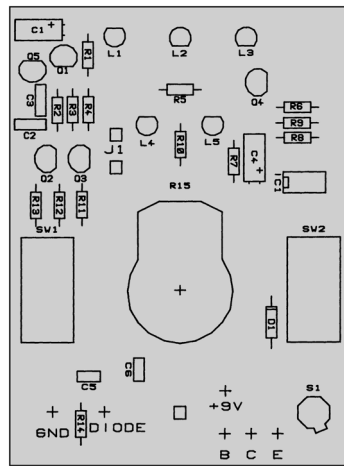
| RESISTORS | CAPACITOR | SEMICONDUCTORS |
|---|--|--|
|  <p>Carbon film</p> <p>100kΩ Potentiometer</p> |  <p>Discap</p> <p>Electrolytic (radial)</p> |  <p>Diode</p> <p>555 IC</p> <p>8-pin Socket</p> <p>Transistor</p> <p>LED</p> |

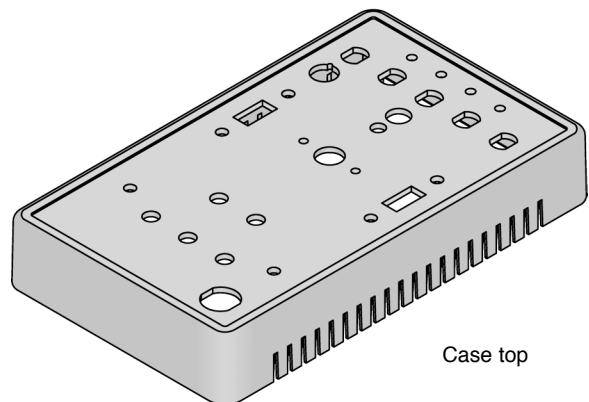
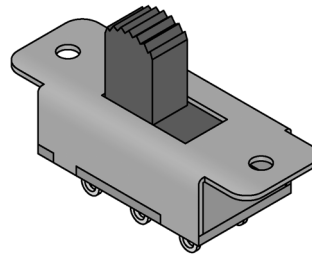
MISCELLANEOUS

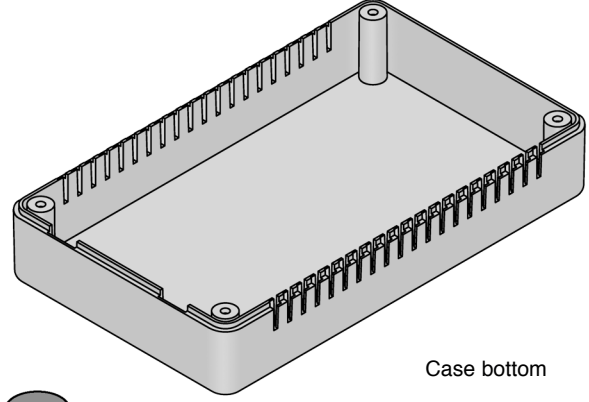
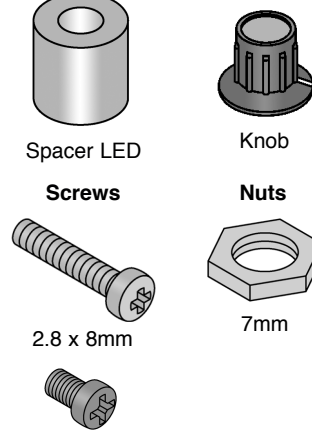
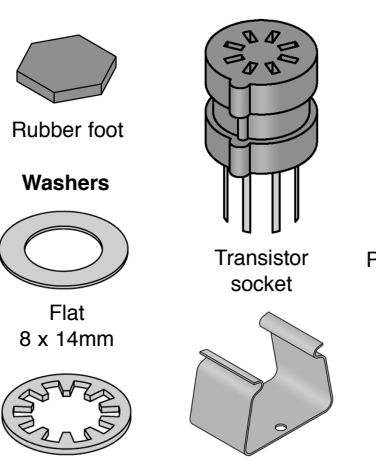
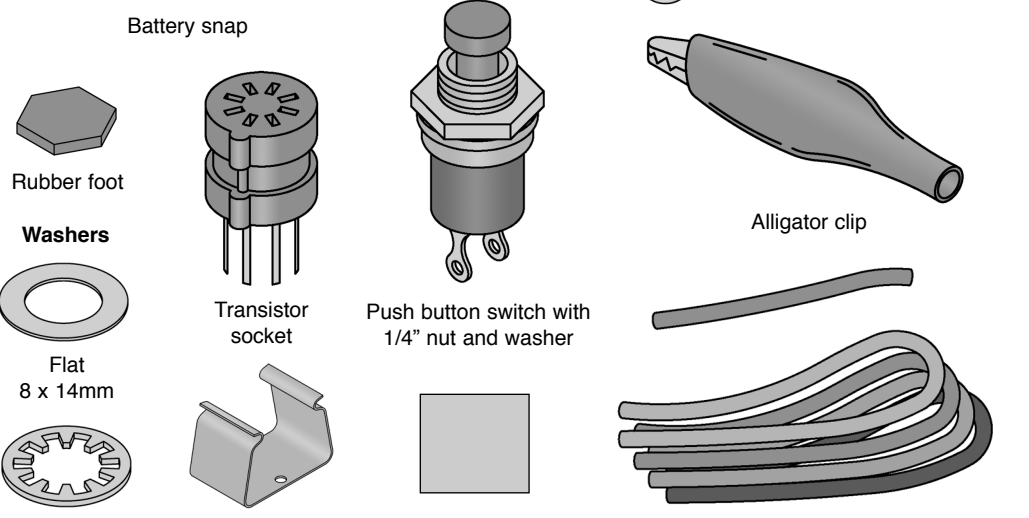
| | | |
|--|---|---|
|  <p>PC Board</p> |  <p>Label</p> |  <p>Case top</p> |
|  <p>Switch DPDT</p> |  <p>Lead-free solder</p> |  <p>Case bottom</p> |
|  <p>Spacer LED</p> <p>Screws</p> <p>2.8 x 8mm</p> <p>M3 x 0.5 x 5mm</p> |  <p>Knob</p> <p>Washers</p> <p>Flat 8 x 14mm</p> <p>Lockwasher 5/16"</p> |  <p>Battery snap</p> <p>Transistor socket</p> <p>Push button switch with 1/4" nut and washer</p> <p>Alligator clip</p> <p>Battery clip</p> <p>Double-sided tape</p> <p>Wires</p> |

CONSTRUCTION

Introduction

The most important factor in assembling your DT-100K Transistor - Diode Kit is good soldering techniques. Using the proper soldering iron is of prime importance. A small pencil type soldering iron of 25 watts is recommended. **The tip of the iron must be kept clean at all times and well-tinned.**

Solder

For many years leaded solder was the most common type of solder used by the electronics industry, but it is now being replaced by lead-free solder for health reasons. This kit contains lead-free solder, which contains 99.3% tin, 0.7% copper, and has a rosin-flux core.

Lead-free solder is different from lead solder: It has a higher melting point than lead solder, so you need higher temperature for the solder to flow properly. Recommended tip temperature is approximately 700°F; higher temperatures improve solder flow but accelerate tip decay. An increase in soldering time may be required to achieve good results. Soldering iron tips wear out faster since lead-free solders are more corrosive and the higher soldering temperatures accelerate corrosion, so proper tip care is important. The solder joint finish will look slightly duller with lead-free solders.

Use these procedures to increase the life of your soldering iron tip when using lead-free solder:

- Keep the iron tinned at all times.
- Use the correct tip size for best heat transfer. The conical tip is the most commonly used.

- Turn off iron when not in use or reduce temperature setting when using a soldering station.
- Tips should be cleaned frequently to remove oxidation before it becomes impossible to remove. Use Dry Tip Cleaner (Elenco® #SH-1025) or Tip Cleaner (Elenco® #TTC1). If you use a sponge to clean your tip, then use distilled water (tap water has impurities that accelerate corrosion).

Safety Procedures

- **Always wear safety glasses or safety goggles to protect your eyes when working with tools or soldering iron, and during all phases of testing.** 
- Be sure there is **adequate ventilation** when soldering.
- Locate soldering iron in an area where you do not have to go around it or reach over it. Keep it in a safe area away from the reach of children.
- **Do not hold solder in your mouth.** Solder is a toxic substance. Wash hands thoroughly after handling solder.

Assemble Components

In all of the following assembly steps, the components must be installed on the top side of the PC board unless otherwise indicated. The top legend shows where each component goes. The leads pass through the corresponding holes in the board and are soldered on the foil side.

Use only rosin core solder.

DO NOT USE ACID CORE SOLDER!

What Good Soldering Looks Like

A good solder connection should be bright, shiny, smooth, and uniformly flowed over all surfaces.

1. Solder all components from the copper foil side only. Push the soldering iron tip against both the lead and the circuit board foil.

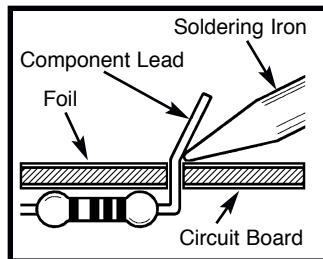

2. Apply a small amount of solder to the iron tip. This allows the heat to leave the iron and onto the foil. Immediately apply solder to the opposite side of the connection, away from the iron. Allow the heated component and the circuit foil to melt the solder.

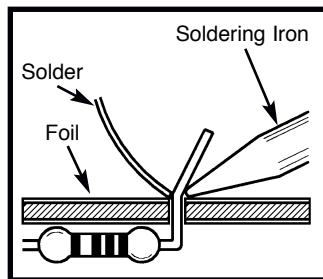

3. Allow the solder to flow around the connection. Then, remove the solder and the iron and let the connection cool. The solder should have flowed smoothly and not lump around the wire lead.

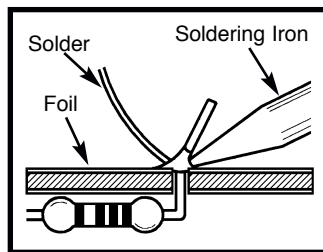

4. Here is what a good solder connection looks like.

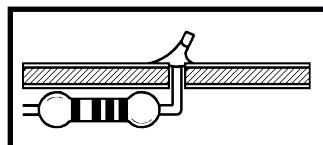

Types of Poor Soldering Connections

1. **Insufficient heat** - the solder will not flow onto the lead as shown.

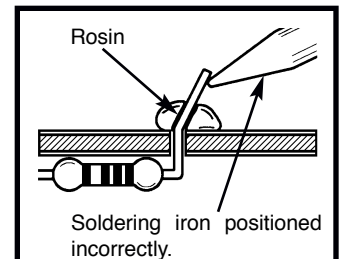

2. **Insufficient solder** - let the solder flow over the connection until it is covered. Use just enough solder to cover the connection.

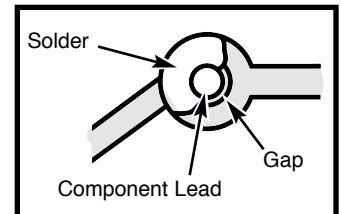

3. **Excessive solder** - could make connections that you did not intend to between adjacent foil areas or terminals.

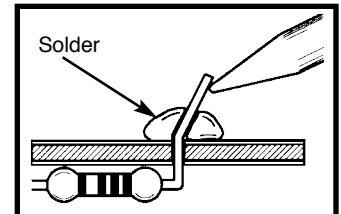

4. **Solder bridges** - occur when solder runs between circuit paths and creates a short circuit. This is usually caused by using too much solder. To correct this, simply drag your soldering iron across the solder bridge as shown.

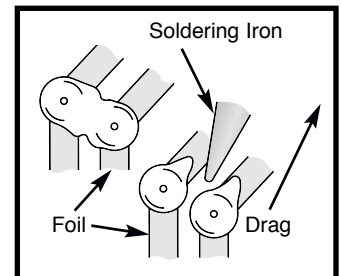

ASSEMBLE THE FOLLOWING COMPONENTS TO THE PC BOARD

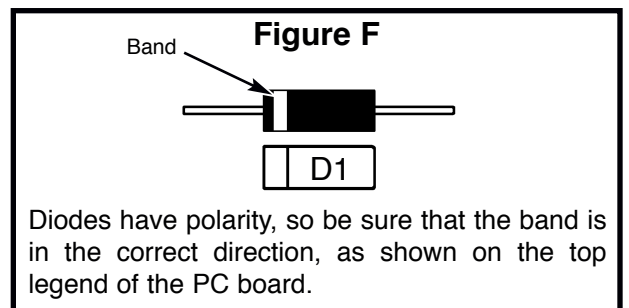
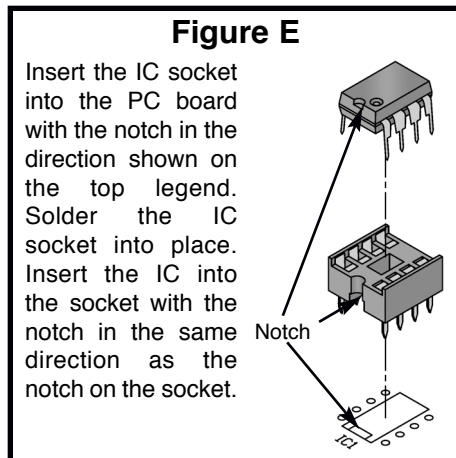
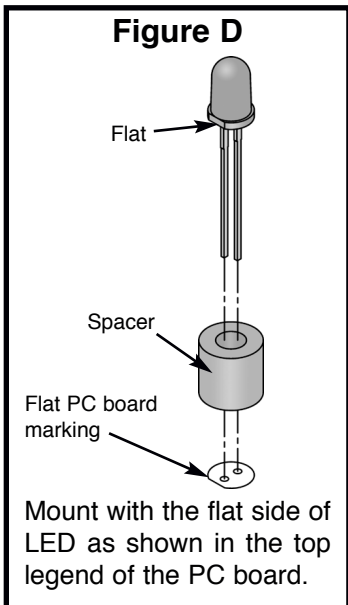
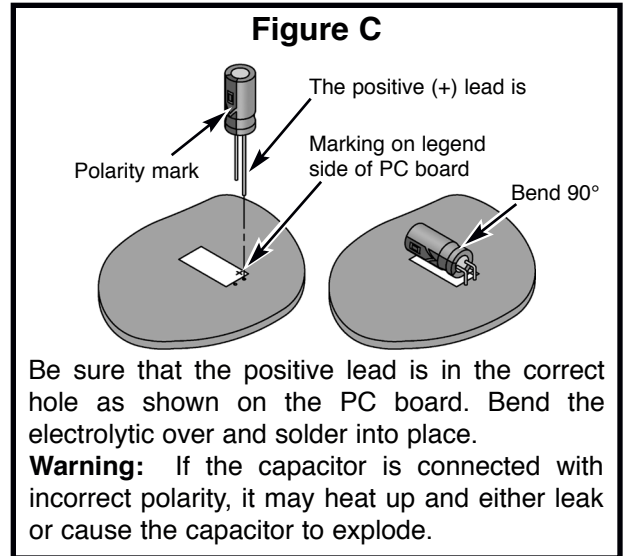
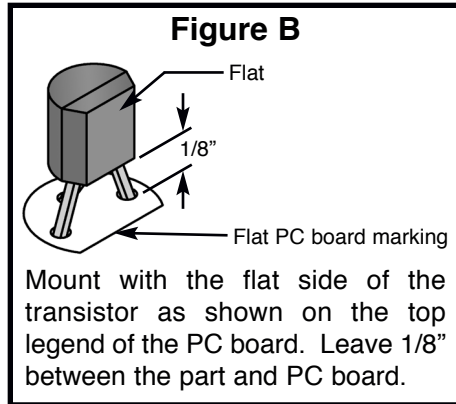
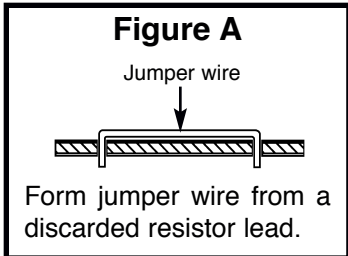
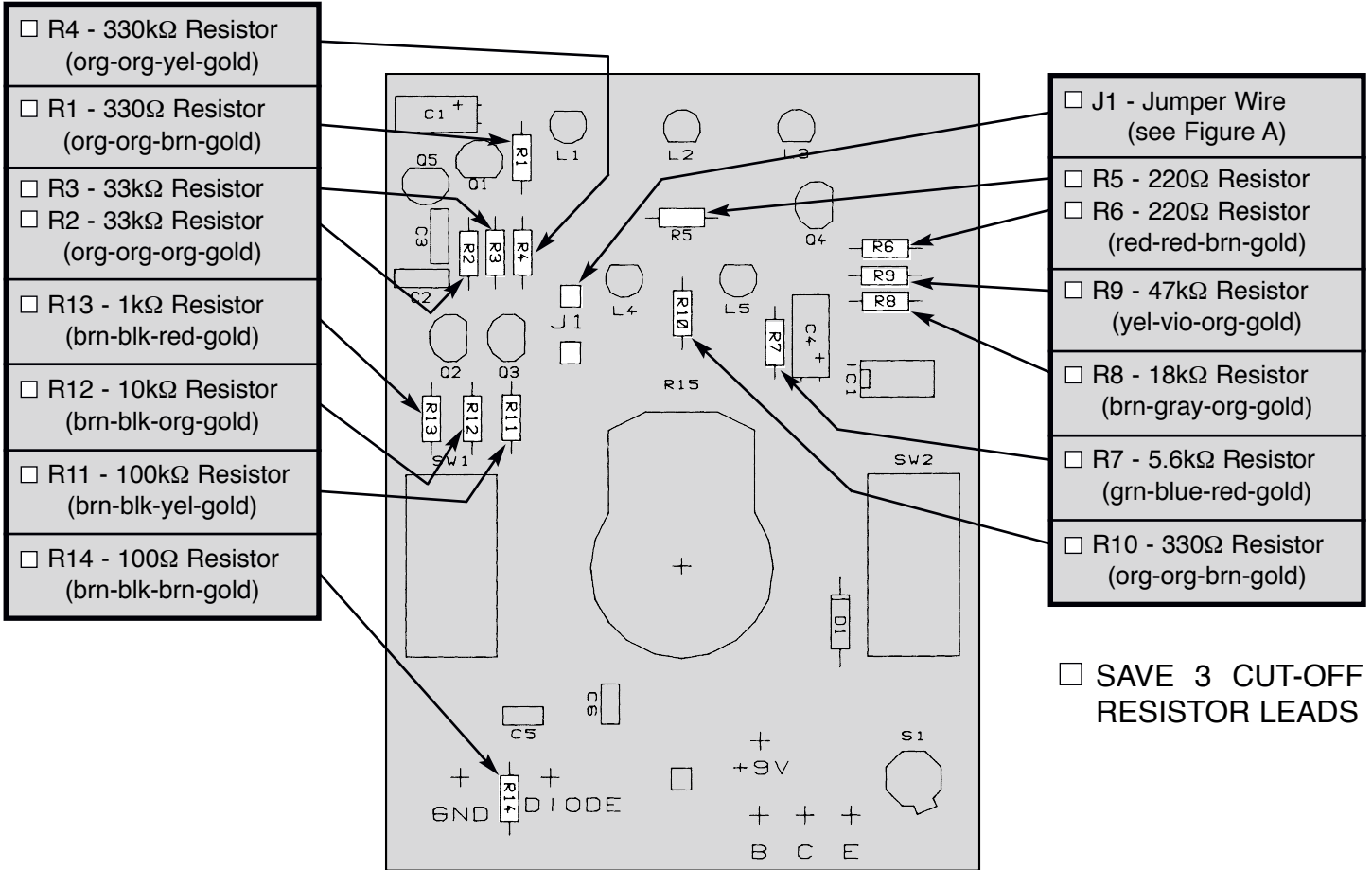

ASSEMBLE THE FOLLOWING COMPONENTS TO THE PC BOARD

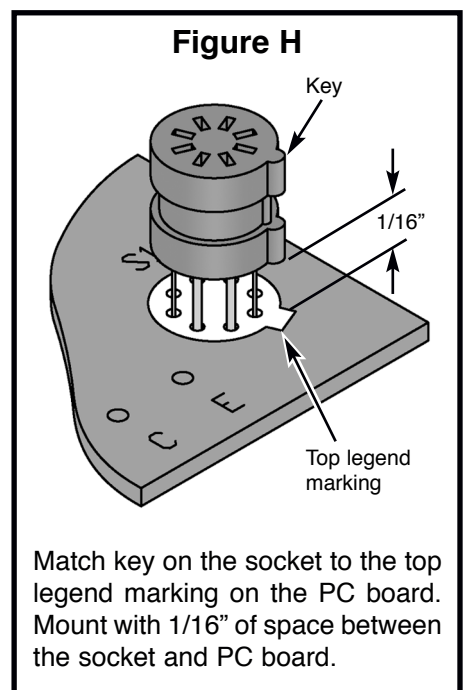
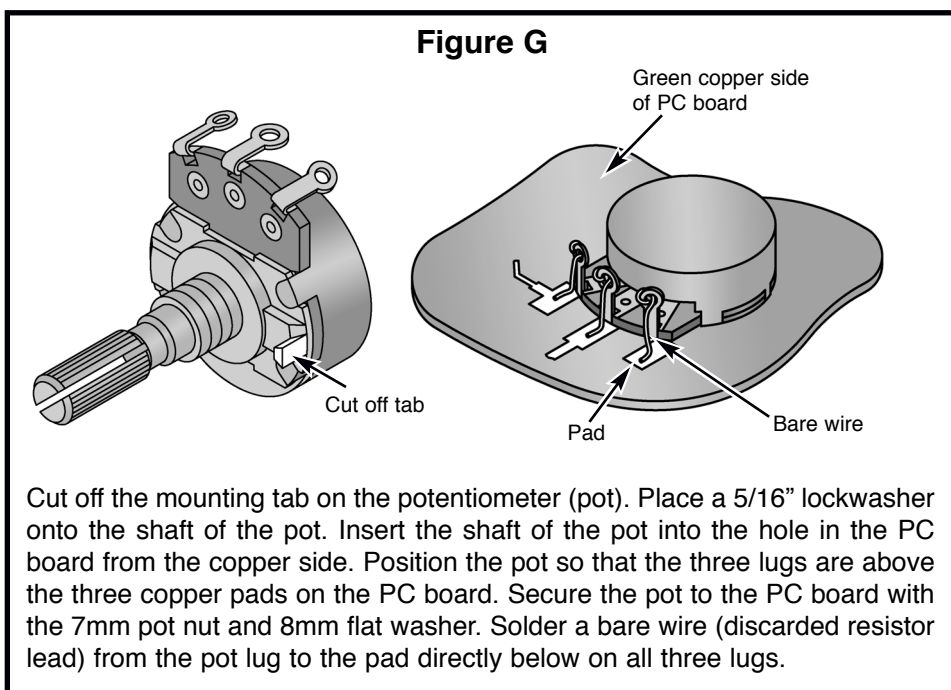
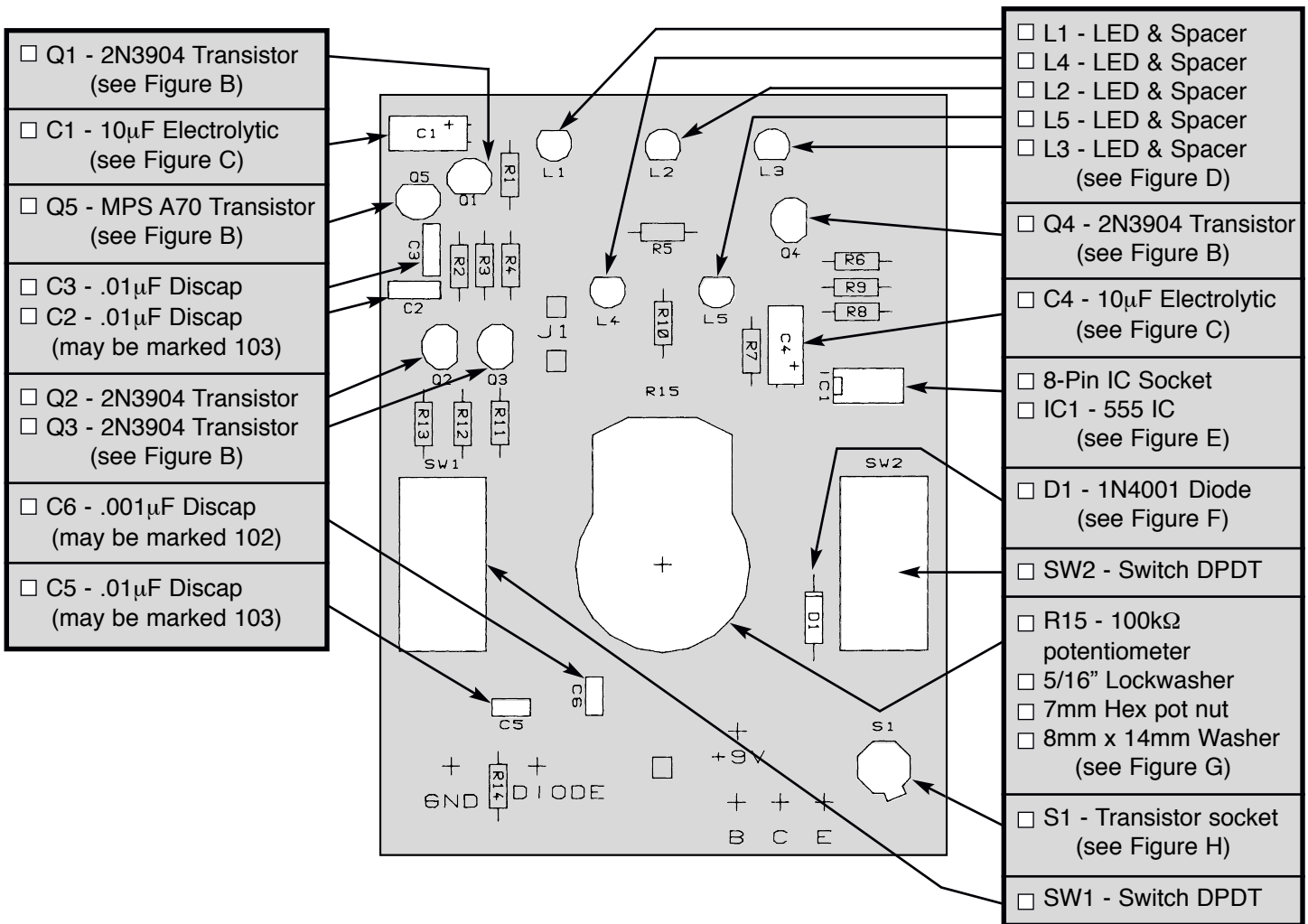

FINAL ASSEMBLY

- ❑ Peel the backing off of the front label and carefully adhere it to the top case, aligning the holes while doing so, as shown in Figure I.
- ❑ Install the push button switch to the top case in the hole marked "TEST" as shown Figure J. Fasten switch in place with the 1/4" nut and washer. Tighten the nut with pliers.
- ❑ Strip 1/4" insulation off both ends of the red wire. Insert one end into the hole marked "DIODE" on the blue legend side of the PC board and solder the wire into place. Tie a knot 2 1/2" from the soldered end of wire. Pull the free end through the hole of the top case marked "DIODE", see Figure K.
- ❑ Strip 1/4" insulation off both ends of the black wire and insert one end into hole "E" on the blue legend side of the PC board and solder the wire into place. Tie a knot 2 1/2" from the soldered end of the wire. Pull the free end through the hole of the top case marked "E", see Figure K.

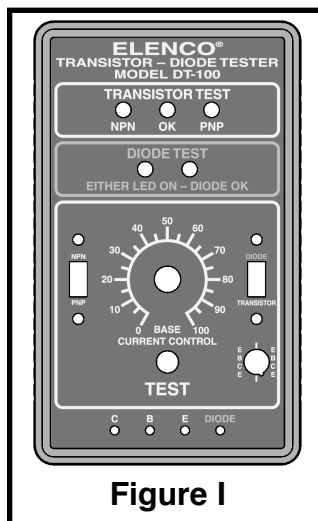

Figure I

- ❑ Strip 1/4" insulation off both ends of the yellow wire and insert one end into hole "B" on the blue legend side of the PC board and solder the wire into place. Tie a knot 2 1/2" from the soldered end of the wire. Pull the free end through the hole of the top case marked "B", see Figure K.
- ❑ Strip 1/4" insulation off both ends of the green wire and insert one end into hole "C" on the blue legend side of the PC board and solder wire into place. Tie a knot 2 1/2" from the soldered end of wire. Pull the free end through the hole of the top case marked "C", see Figure K.

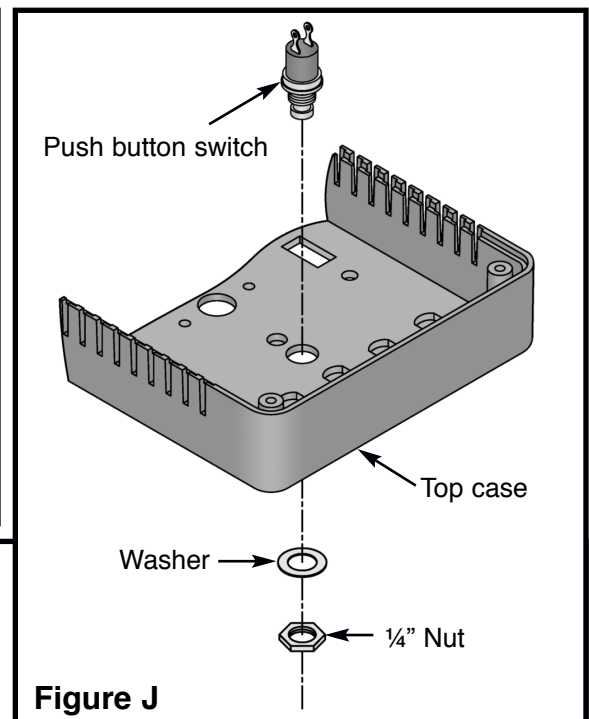

Figure J

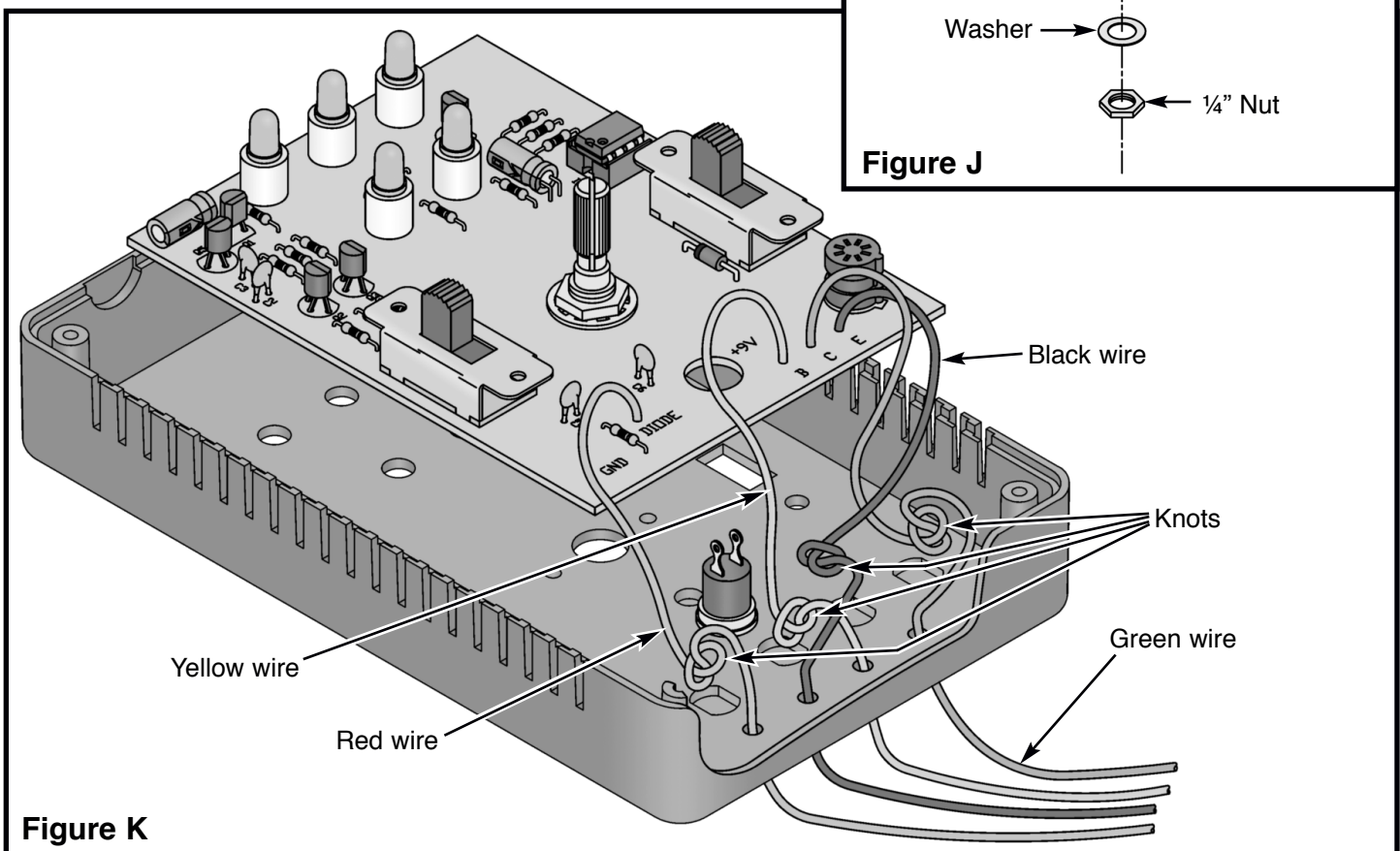

Figure K

- ❑ Strip the insulation off both ends of the blue wire to expose 1/4" of bare wire. Solder one end to the hole on the copper side of the PC board, as shown in Figure L. Solder the other end of the wire to a lug on the push button switch.

- ❑ Solder the red wire from the battery snap to the other lug on the push button switch, as shown in Figure L.
- ❑ Insert the black wire from the battery snap into the pad on the PC board from the copper side. Solder the wire in place, as shown in Figure L.

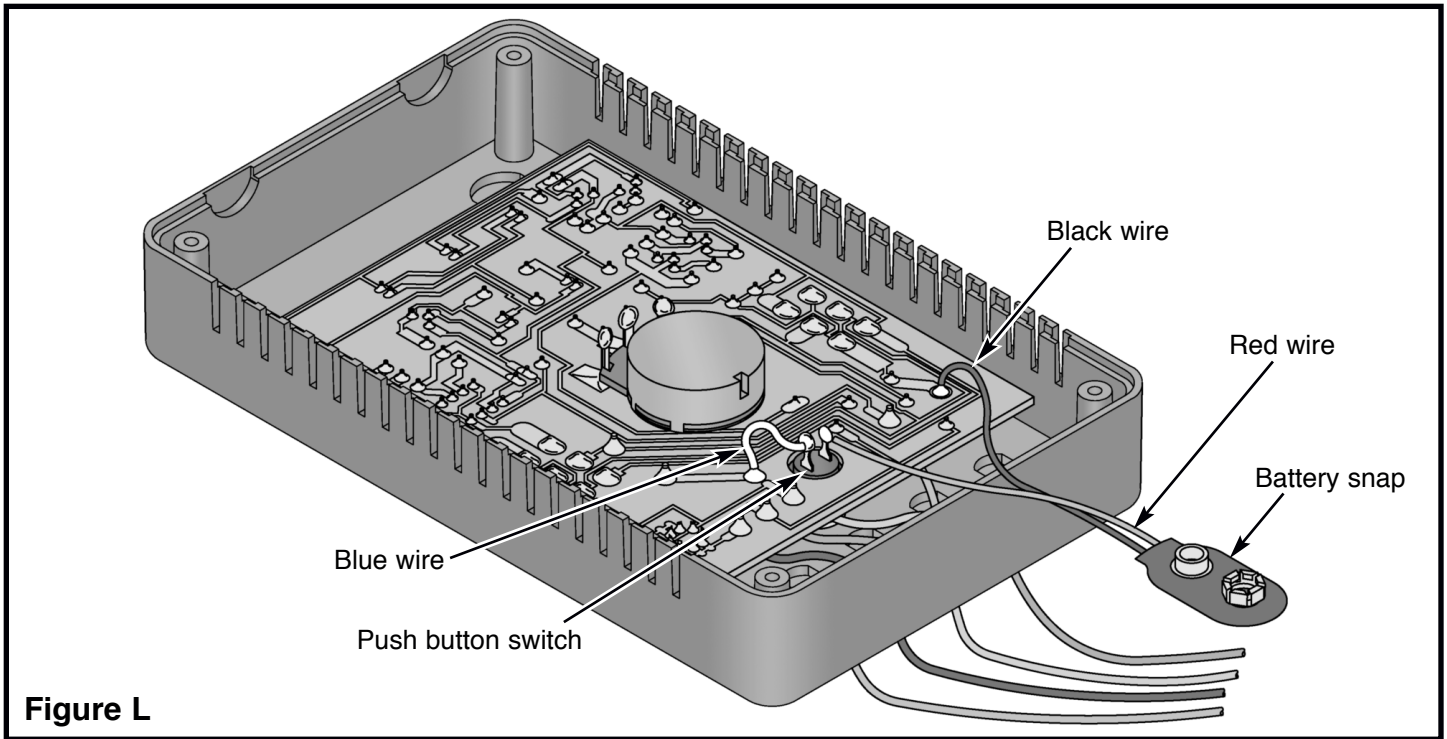

Figure L

- ❑ Mount the front panel to the switches on the PC board using four M3 x 0.5 x 5mm screws (see Figure M).

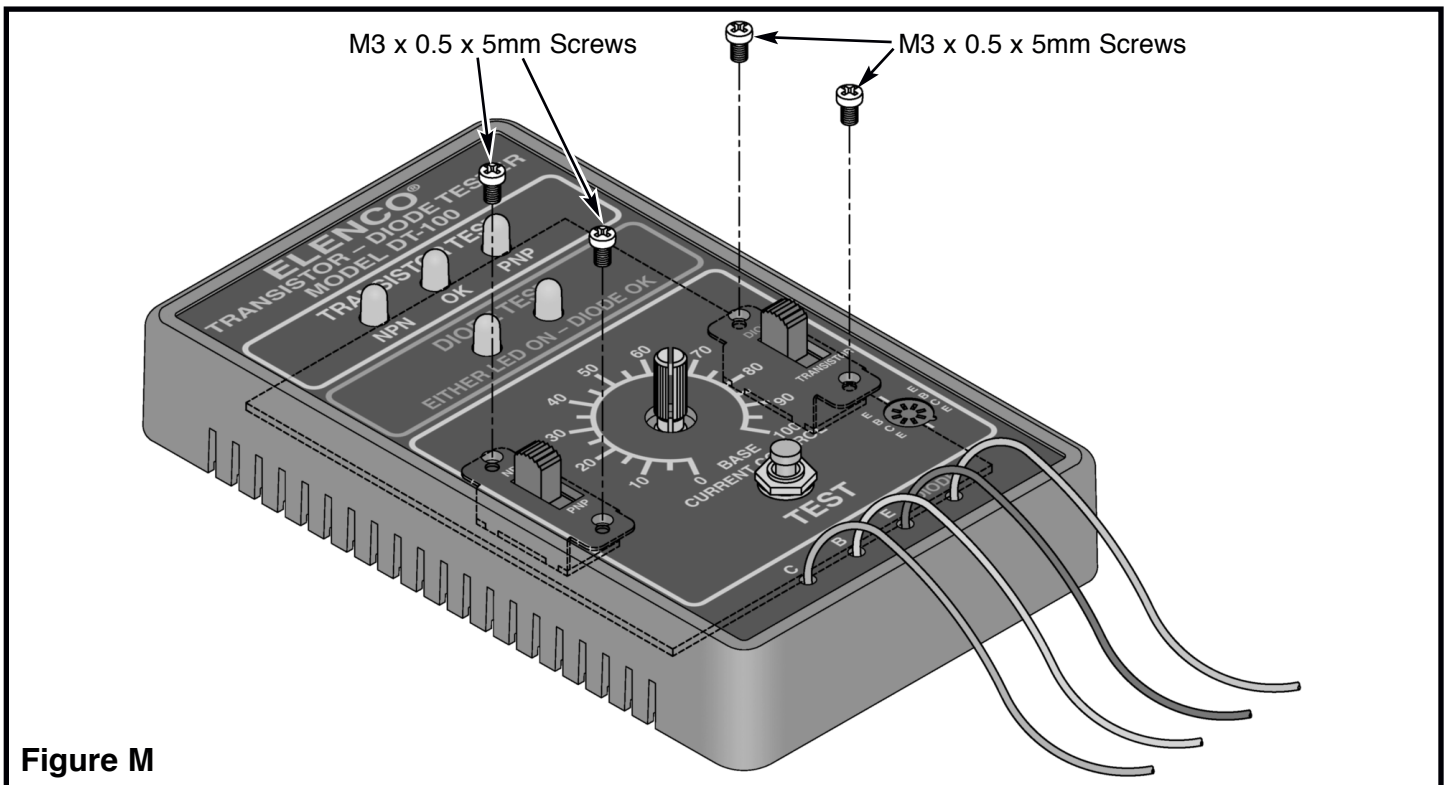
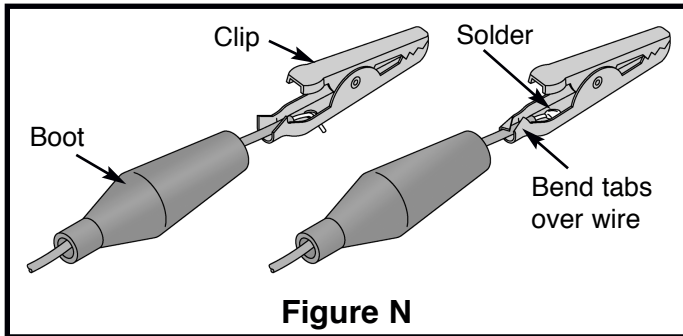
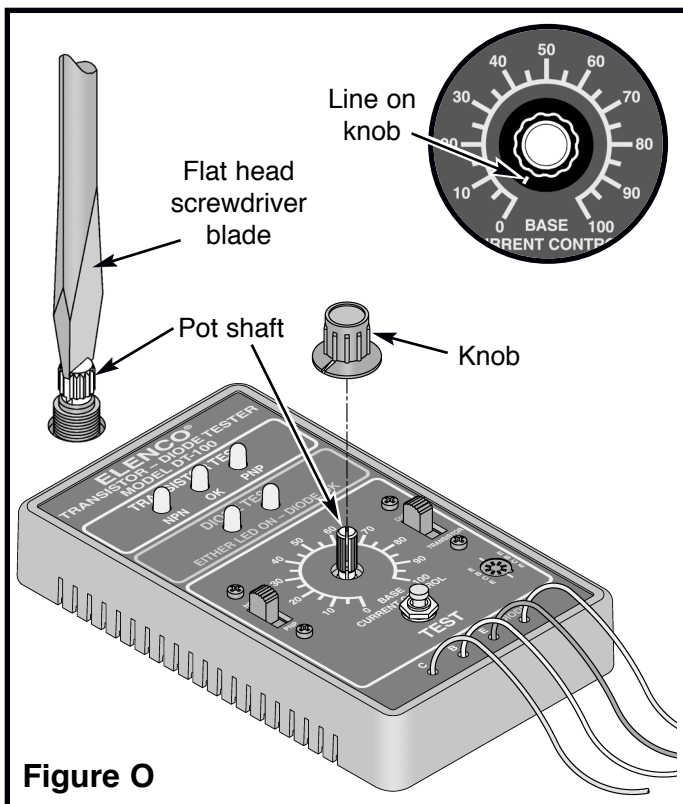

Figure M

- ❑ Remove the colored boots from the four alligator clips (to remove the boots, clip the alligator clip onto a pencil and slide the boot off). Slide each boot onto the four corresponding colored wires (black boot onto black wire, etc.).
- ❑ Solder an alligator clip to each wire as shown in Figure N. Slide the boots back onto the clips.



- ❑ Turn the shaft of the base current control fully counter-clockwise. Align the marker line on the knob with "0" on the front panel, see Figure O. Push the knob onto the shaft.
- ❑ Peel off one side of the protective backing on the double-sided tape and attach it to the battery clip. Now, peel off the other side and attach the clip to the case as shown in Figure P.
- ❑ Obtain a 9 volt battery (alkaline preferred) and press the battery snap onto the battery terminals.
- ❑ Insert the battery into the battery clip.



- ❑ Remove the backing from each rubber foot and place them in the locations shown in Figure Q.
- ❑ Assemble the top and bottom case sections and fasten with four 2.8 x 8mm self-tapping screws as shown in Figure Q. Make sure the slots on the side line up with one another.

Your transistor/diode tester is now completed and ready for testing.

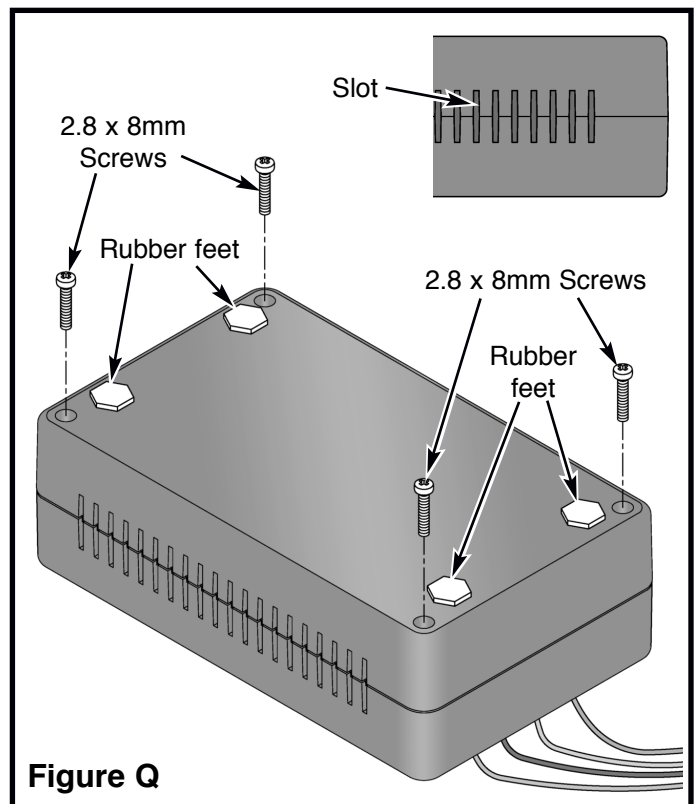
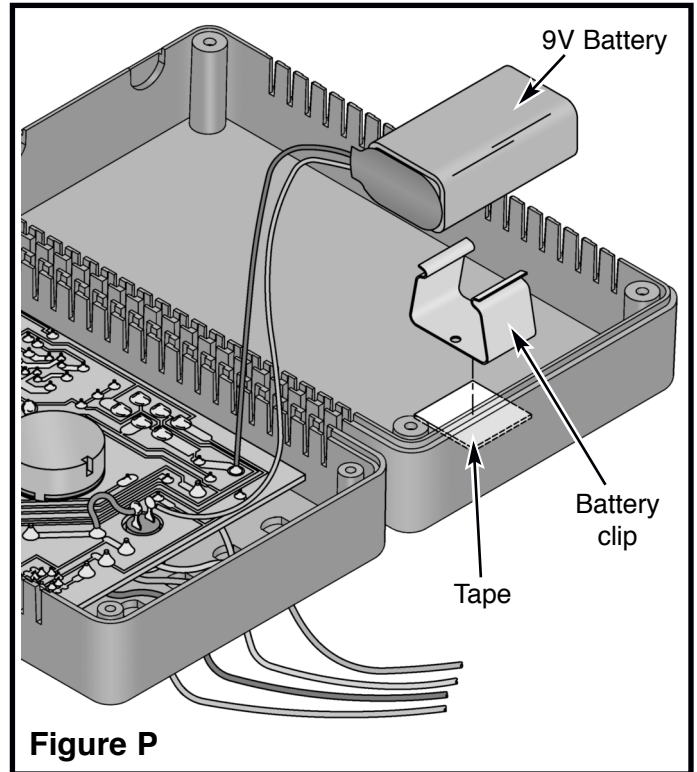

CHECKING OUT YOUR TRANSISTOR/DIODE TESTER

The following is a simple procedure for testing your DT-100. If the tests fail, refer to the troubleshooting guide for help.

Diode Operation:

1. Place the switch in the diode position. Short the black and red leads together and push in the test button. The diode test LEDs should alternately go on at about a 1Hz rate.
2. Connect the red and black leads to any good diode. Only one LED should flash identifying the red lead connection (anode or cathode). Reversing the leads should cause the other LED to flash.



Transistor Operation: (using leads)

1. Place the switch in transistor position. Short the yellow (B) and black (E) leads together. Press the test button. Vary the base current control. The NPN lamp should light with the switch in NPN and the PNP when in PNP position.

(using socket)

2. Place a known good transistor in the test socket with the Emitter in E, Base in B and Collector in C pins. Be sure none of the leads are shorting. Vary the base current control. The OK LED should light. Note that on NPN transistor, the NPN lamp also will glow very slightly. This indicates the base current. The higher the beta of the transistor, the lower the base current, and thus, lower intensity. The base current control should be adjusted for the lowest setting with the OK lamp glowing.

OPERATING INSTRUCTIONS

The DT-100 is a dynamic transistor and diode tester. It features in-circuit testing and polarity indicators for both transistors and diodes.

Diode Testing

1. Place switch in diode position.
2. Connect diode to red and black leads.
3. Push in test switch. One diode LED should blink and identify whether the cathode or anode is connected to the diode (red) lead.
4. If both LED lamps blink, then the diode is shorted.
5. If neither lights, then the diode is open.

Transistor Testing

The DT-100 can measure transistors in or out of circuit. It will identify NPN or PNP by a simple adjustment.

Transistor testing - Out of Circuit

1. Place switch in transistor position.
2. Place transistor in socket or attach to C, B, E leads. If collector C, base B and emitter E are not known, assume B is the center lead on small plastic transistors and C the metal case or tab on power transistors.
3. Push in test button. Adjust the base current control so that OK LED lights. This indicates a good transistor.

4. If OK lamp does not light, then adjust the base current control that either NPN or PNP LED lights. This happens at minimum or maximum position of the control setting. This will indicate transistor type. Place switch to NPN if the NPN lamp lights, to PNP if PNP lamp is lit.
5. If no lamps light, the transistor is open or we have not identified the base lead. Repeat assuming another lead as base.
6. When the transistor is shown to be OK, the base current control gives an indication of transistor beta. The lower the setting relative to another transistor, the higher the beta. Lamps NPN and PNP measure base current. Higher base current results in a brighter LED. It also indicates if current is entering or leaving the base, thus NPN or PNP respectively will light.

Transistor Testing - In Circuit

The DT-100 will test transistors in circuit provided the base biasing resistance is greater than 100 ohms. Simply follow the previous procedure for testing out of circuit transistors. Do not apply power to circuit of transistor or diode under test. The DT-100 will supply the necessary power.

THEORY OF OPERATION

Note the schematic diagram on the back cover of this manual. The test transistor in this circuit is a NPN. Adjusting the variable resistor will cause the NPN LED to light, indicating that base current is flowing. The output of the test transistor is fed to amplifier Q2 and Q3. The output of Q2 is fed back in phase to the base of the test transistor causing the circuit to oscillate. Part of the oscillations are fed to a power rectifier Q5 which switches on the OK LED indicator.

The design configuration is such that in-circuit transistors can be measured provided that the base and collector resistors are greater than 100 ohms.

When measuring PNP transistors, the power supplied to the test transistor is reversed via the NPN/PNP switch, therefore the PNP LED will light.

Varying the base current control will reduce the base current. The lower the base current, the higher the gain of the transistor under test. Comparative tests of two transistors gain (beta) can be made by observing the dial setting or the intensity of the base LED diode. The lower the setting with the PNP LED lit, the higher the beta of that transistor.

On diode operation, power is applied to IC1. This causes the circuit to oscillate at about a 1Hz rate. Placing a diode in series with the LED indicators will cause a current to flow depending on the direction of the diode. Thus, the red test lead will identify the cathode or anode of the diode via the LED readout. Transistor Q4 reverses the current flow in this circuit.

All types of diodes may be tested: Silicon, germanium, LEDs or zeners over 6 volts. Zener diodes under 6V causes the second LED to glow at lower intensity, indicating that zener breakdown has occurred.

TROUBLESHOOTING GUIDE

If any problems occur, first check your wiring and soldering. Keep in mind that most problems are due to poor soldering or wiring errors. Be sure that there are no solder shorts, poor connections or wiring errors. Check that the battery is connected. Be sure that the transistors are in correctly. Check the LEDs. The LED leads are hard to identify and can easily be wired backwards. The following is a guide to help solve most problems.

Diode Position: Red and black leads shorted together. LEDs should alternately blink at 1Hz rate.

- A. LEDs do not blink.** Check that IC1 is in correctly. Check wiring around IC1.
- B. Only one LED blinks.** Check for open LED. Check transistor Q4.
- C. Both LEDs blink together.** One LED is in backwards.

Transistor Position Using Leads: B&E test leads shorted together. Rotate base current from minimum to maximum. NPN LED should light up when switched to NPN and PNP LED should light when in PNP position. OK LED should not light.

- A. No LEDs light.** Check that the battery is connected properly. Check for open circuit at R15, B or E leads.
- B. Only one LED lights.** Check wiring and soldering. Check for open LED.
- C. Both LEDs light at the same time.** LED is in backwards.

Transistor Position Using Socket: Put the good NPN transistor into the test socket. Switch SW1 to NPN position. Rotate base current control. The OK lamp should light. If not, check the following:

- A.** No test leads are shorting together.
- B.** The NPN LED should be lit. If not, then refer to I.
- C.** Components around transistors Q1 to Q5 are in properly. Be sure no soldering errors exist.
- D.** Transistors are not in backwards.
- E.** Touch the collector of Q1 with the black (E) test leads. The OK LED should light. If not, then the LED is either open or in backwards.
- F.** Look for a possible defective transistor or other component.

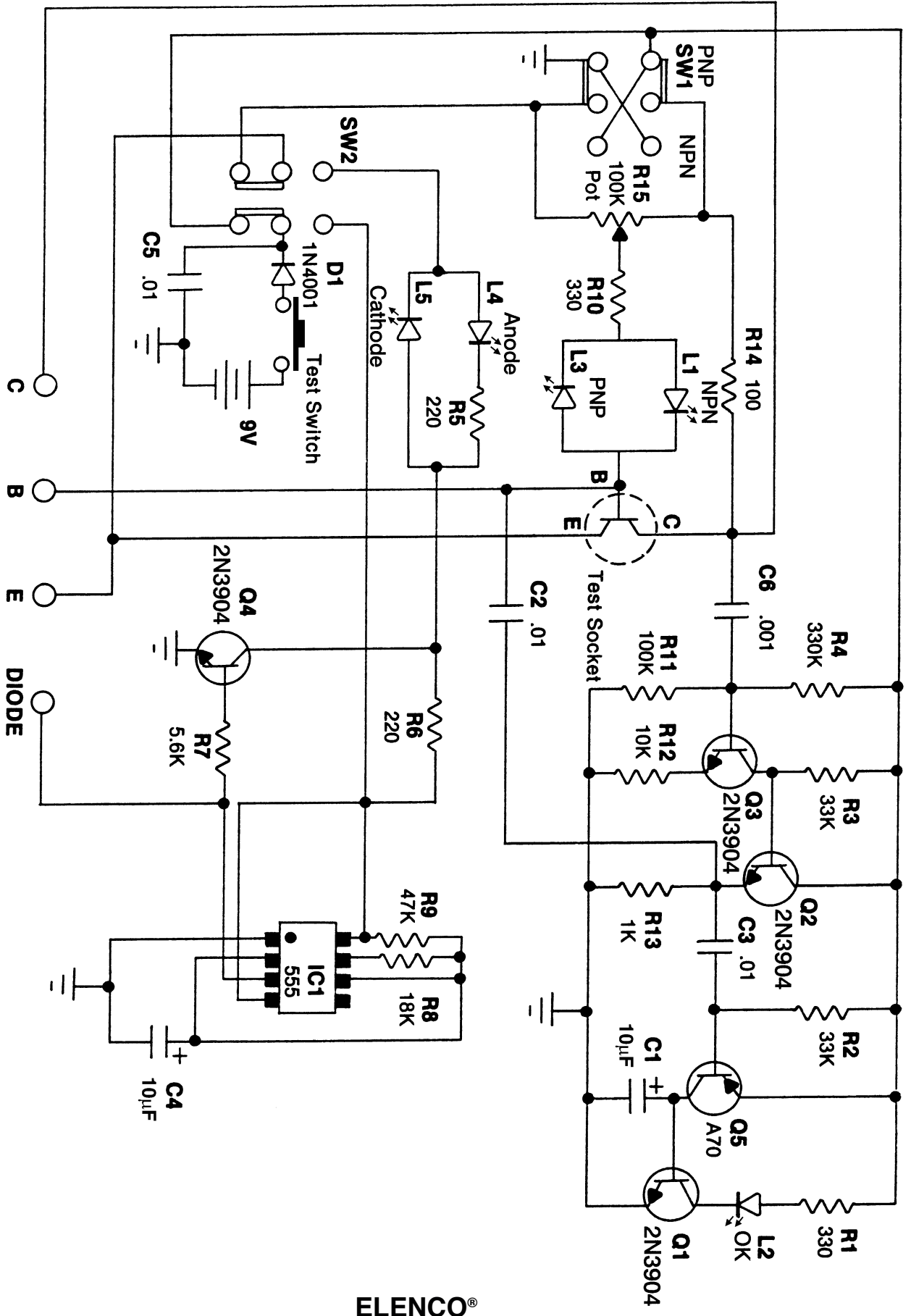

**SCHEMATIC DIAGRAM - DT-100
REV-D**

ELENCO®

150 Carpenter Avenue • Wheeling, IL 60090
(847) 541-3800 • www.elenco.com • e-mail: elenco@elenco.com