

PRICE \$1.00

HEATH COMPANY BENTON HARBOR, MICHIGAN

# HEATHKIT<sup>®</sup> ASSEMBLY MANUAL

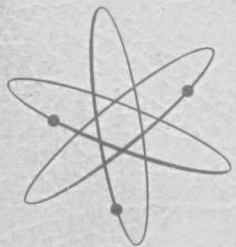

**AUDIO GENERATOR**

**MODEL IG-72**

# RESISTOR AND CAPACITOR COLOR CODES

## RESISTORS

The colored bands around the body of a color coded resistor represent its value in ohms. These colored bands are grouped toward one end of the resistor body. Starting with this end of the resistor, the first band represents the first digit of the resistance value; the second band represents the second digit; the third band represents the number by which the first two digits are multiplied. A fourth band of gold or silver represents a tolerance of  $\pm 5\%$  or  $\pm 10\%$  respectively. The absence of a fourth band indicates a tolerance of  $\pm 20\%$ .

The physical size of a composition resistor is related to its wattage rating. Size increases progressively as the wattage rating is increased. The diameters of 1/2 watt, 1 watt and 2 watt resistors are approximately 1/8", 1/4" and 5/16", respectively.

The color code chart and examples which follow provide the information required to identify color coded resistors.

COLOR	CODE		MULTIPLIER
	1ST DIGIT	2ND DIGIT	
BLACK	0	0	1
BROWN	1	1	10
RED	2	2	100
ORANGE	3	3	1,000
YELLOW	4	4	10,000
GREEN	5	5	100,000
BLUE	6	6	1,000,000
VIOLET	7	7	10,000,000
GRAY	8	8	100,000,000
WHITE	9	9	1,000,000,000
GOLD	-	-	.1
SILVER	-	-	.01

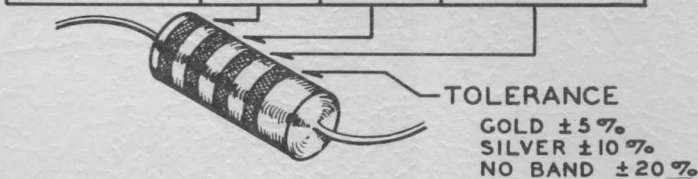

### EXAMPLES

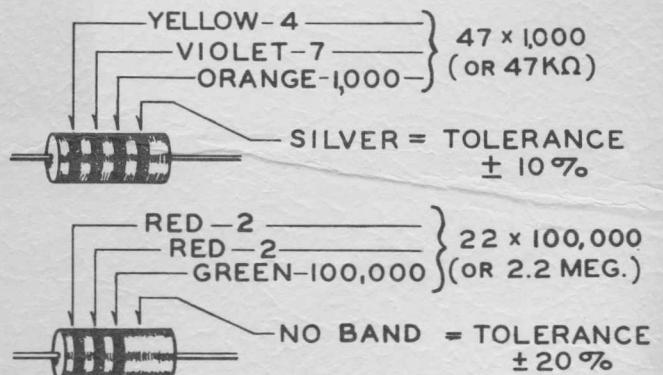

## CAPACITORS

Generally, only mica and tubular ceramic capacitors, used in modern equipment, are color coded. The color codes differ somewhat among capacitor manufacturers, however the codes

shown below apply to practically all of the mica and tubular ceramic capacitors that are in common use. These codes comply with EIA (Electronics Industries Association) Standards.

### MICA

COLOR	CODE		MULTIPLIER	TOLER. %
	1ST DIGIT	2ND DIGIT		
BLACK	0	0	1	$\pm 20$
BROWN	1	1	10	$\pm 1$
RED	2	2	100	$\pm 2$
ORANGE	3	3	1,000	$\pm 3$
YELLOW	4	4	10,000	—
GREEN	5	5	—	$\pm 5$
BLUE	6	6	—	—
VIOLET	7	7	—	—
GRAY	8	8	—	—
WHITE	9	9	—	—
GOLD	-	-	.1	$\pm 10$
SILVER	-	-	.01	$\pm 10$

### EXAMPLE

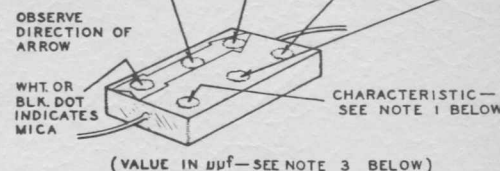
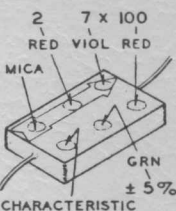

### TUBULAR CERAMIC

Place the group of rings or dots to the left and read from left to right.

COLOR	CODE		MULTIPLIER	TOLER. %
	1ST DIGIT	2ND DIGIT		
BLACK	0	0	1	$\pm 20$ OR LESS OVER 10
BROWN	1	1	10	$\pm 1$
RED	2	2	100	$\pm 2$
ORANGE	3	3	1,000	$\pm 2.5$
YELLOW	4	4	10,000	—
GREEN	5	5	—	$\pm 0.5$
BLUE	6	6	—	$\pm 5$
VIOLET	7	7	—	—
GRAY	8	8	—	$\pm 0.25$
WHITE	9	9	—	$\pm 1.0$

### EXAMPLE

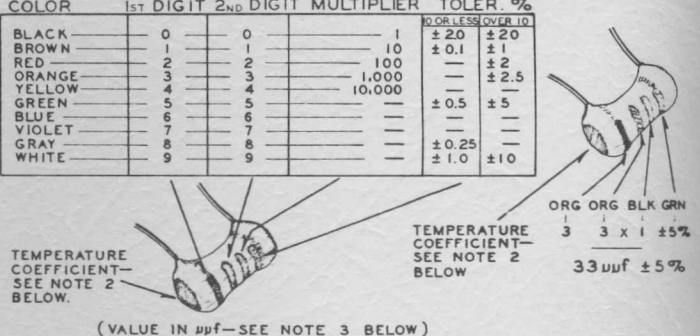

### NOTES:

1. The characteristic of a mica capacitor is the temperature coefficient, drift capacitance and insulation resistance. This information is not usually needed to identify a capacitor but, if desired, it can be obtained by referring to EIA Standard, RS-153 (a Standard of Electronic Industries Association.)

2. The temperature coefficient of a capacitor is the predictable change in capacitance with temperature change and is

expressed in parts per million per degree centigrade. Refer to EIA Standard, RS-198 (a Standard of Electronic Industries Association.)

3. The farad is the basic unit of capacitance, however capacitor values are generally expressed in terms of µfd (microfarad, .000001 farad) and µµf (micro-micro-farad, .000001 µfd); therefore, 1,000 µµf = .001 µfd, 1,000,000 µµf = 1µfd.

### USING A PLASTIC NUT STARTER

A plastic nut starter offers a convenient method of starting the most used sizes: 3/16" and 1/4" (3-48 and 6-32). When the correct end is pushed down over a nut, the pliable tool conforms to the shape of the nut and the nut is gently held while it is being picked up and started on the screw. The tool should only be used to start the nut.

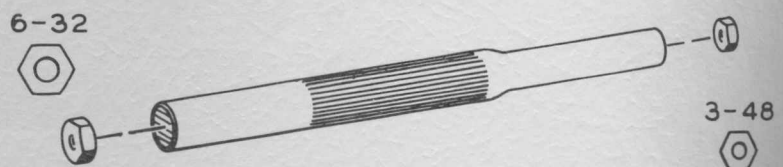

Assembly  
and  
Operation  
of the



AUDIO  
GENERATOR

MODEL IG-72



HEATH COMPANY,  
BENTON HARBOR,  
MICHIGAN

TABLE OF CONTENTS

Introduction. . . . .	2
Construction Notes. . . . .	2
Parts List. . . . .	3
Proper Soldering Techniques. . . . .	5
Step-By-Step Procedure. . . . .	7
Step-By-Step Assembly -	
Parts Mounting - Chassis. . . . .	8
Parts Mounting - Front Panel. . . . .	10
Switch Wiring. . . . .	12
Wiring-Chassis Bottom. . . . .	16
Wiring-Chassis Top. . . . .	20
Initial Test And Adjustment. . . . .	22
Final Assembly. . . . .	24
Operation. . . . .	25
In Case Of Difficulty. . . . .	26
Service Information -	
Service. . . . .	27
Replacements. . . . .	28
Shipping Instructions. . . . .	28
Specifications. . . . .	29
Circuit Description. . . . .	30
Schematic. . . . (fold-out from page). . . . .	31
Warranty. . . . .	32

## INTRODUCTION

The Heathkit Model IG-72 Audio Generator, which is designed for laboratory use, provides nearly perfect sine wave signals with metered output level. This Audio Generator can be used as a signal source for bridge and harmonic distortion measurements, as an external modulator for an RF signal generator, and in testing audio amplifiers for gain and frequency response.

Accurate, repeatable frequency selection is accomplished by the use of three switches. These switches select the first two significant figures and multiplier of frequencies between 10 cps and 100 kc.

The Generator can provide output signals into a high impedance load (10,000  $\Omega$  and higher) with full scale (F.S.) ranges of .003 to 10 volts. Many uses require a signal source with 600  $\Omega$  (industry standard) impedance. Such signals are available from the Generator with full scale ranges of .003 to 1 volt.

Simplicity in design results in economy without loss of performance, and it also provides a satisfying assembly experience. Careful assembly will result in stable performance and a long useful life of the Generator.

## CONSTRUCTION NOTES

This manual is supplied to assist you in every way to complete your kit with the least possible chance for error. The arrangement shown is the result of extensive experimentation and trial. If followed carefully, the result will be highly stable and dependable performance. We suggest that you retain the manual in your files for future reference, both in the use of the equipment and for its maintenance.

**UNPACK THE KIT CAREFULLY AND CHECK EACH PART AGAINST THE PARTS LIST.** In so doing, you will become acquainted with the parts. Refer to the information on the inside covers of the manual to help you identify the components. If some shortage or parts damage is found in checking the Parts List, please read the Replacements section and supply the information called for therein.

Resistors generally have a tolerance rating of 10% unless otherwise stated in the Parts List. Tolerances on capacitors are generally even greater. Limits of +100% and -20% are common for electrolytic capacitors.

We suggest that you do the following before work is started:

1. Lay out all parts so that they are readily available.
2. Provide yourself with good quality tools. Basic tool requirements consist of a screwdriver with a 1/4" blade; a small screwdriver with a 1/8" blade; long-nose pliers; wire cutters, preferably separate diagonal cutters; a penknife or a tool for stripping insulation from wires; and a soldering iron (or gun). A set of nut drivers, while not necessary, will aid extensively in construction of the kit.

Most kit builders find it helpful to separate the various parts into convenient categories. Muffin tins or molded egg cartons make convenient trays for small parts. Resistors and capacitors may be placed with their lead ends inserted in the edge of a piece of corrugated cardboard until they are needed. Values can be written on the cardboard next to each component. The illustration shows one method that may be used.

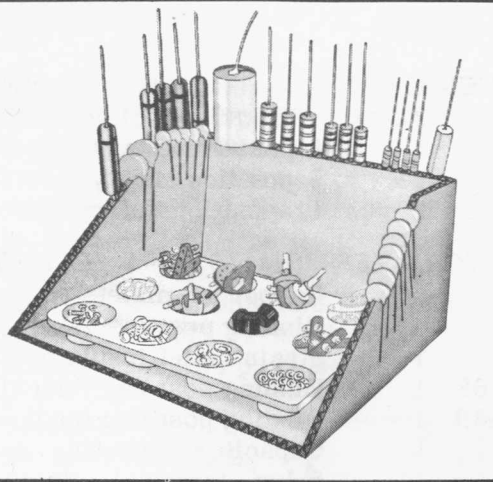

### PARTS LIST

The numbers in parentheses in the Parts List are keyed to the numbers on the Parts Pictorial (fold-out from Page 5) to aid in parts identification.

PART No.	PARTS Per Kit	DESCRIPTION	PART No.	PARTS Per Kit	DESCRIPTION
<b>RESISTORS</b>			<b>2 Watt and 20 Watt</b>		
<b>1/2 Watt</b>			(3)1B-10	1	47 K $\Omega$ 2 watt (yellow-violet-orange)
(1)1-1	1	47 $\Omega$ (yellow-violet-black)	(4)3T-2	1	5000 $\Omega$ 20 watt
1-4	1	330 $\Omega$ (orange-orange-brown)	<b>CAPACITORS</b>		
1-94	1	390 $\Omega$ (orange-white-brown)	(5)20-1	1	47 $\mu\mu\text{f}$ mica (yellow-violet-black)
1-95	1	560 $\Omega$ (green-blue-brown)	20-55	1	500 $\mu\mu\text{f}$ mica (green-black-brown)
1-96	1	750 $\Omega$ (violet-green-brown)	(6)23-67	1	.005 $\mu\text{fd}$ tubular
1-97	5	1100 $\Omega$ (brown-brown-red)	23-68	1	.05 $\mu\text{fd}$ tubular
1-98	5	1600 $\Omega$ (brown-blue-red)	23-69	1	.5 $\mu\text{fd}$ tubular
1-90	1	2000 $\Omega$ (red-black-red)	(7)25-5	1	16 $\mu\text{fd}$ 150 V electrolytic
1-89	1	2400 $\Omega$ (red-yellow-red)	25-16	1	20 $\mu\text{fd}$ 350 V electrolytic
1-16	1	4700 $\Omega$ (yellow-violet-red)	(8)25-37	1	40-40 $\mu\text{fd}$ 450 V electrolytic
1-20	2	10 K $\Omega$ (brown-black-orange)	<b>CONTROLS</b>		
1-121	1	120 K $\Omega$ (brown-red-yellow)	(9)10-34	1	600 $\Omega$
1-99	2	240 K $\Omega$ (red-yellow-yellow)	10-7	1	5000 $\Omega$
1-87	2	330 K $\Omega$ (orange-orange-yellow)	10-8	1	10 K $\Omega$
1-100	2	510 K $\Omega$ (green-brown-yellow)			
1-101	2	1 megohm (brown-black-green)			
(2)2-97	2	25 K $\Omega$ 1%			
2-98	2	33.3 K $\Omega$ 1%			
2-99	2	50 K $\Omega$ 1%			
2-11	2	100 K $\Omega$ 1%			

<u>PART No.</u>	<u>PARTS Per Kit</u>	<u>DESCRIPTION</u>	<u>PART No.</u>	<u>PARTS Per Kit</u>	<u>DESCRIPTION</u>
<b>SWITCHES</b>			<b>TUBES-LAMPS</b>		
(10) 60-1	2	SPST slide	411-11	1	6AU6 tube
(11) 63-8	1	4-position rotary	411-63	1	6CL6 tube
63-107	1	8-position rotary	411-64	1	6X4 tube
63-108	2	11-position rotary	412-4	1	#50 pilot lamp
<b>INSULATORS-TERMINAL STRIPS-SOCKETS</b>			412-2	1	3 watt candelabra lamp
(12) 73-1	3	Rubber grommet	<b>WIRE-SLEEVEING</b>		
(13) 75-17	4	Binding post insulator	89-1	1	Line cord
(14) 75-71	1	Strain relief insulator	340-2	1	Bare wire
(15) 100-M16B	1	Binding post cap (black)	344-51	1	Brown hookup wire
100-M16R	1	Binding post cap (red)	344-52	1	Red hookup wire
(16) 481-3	1	Capacitor mounting wafer	344-59	1	White hookup wire
(17) 431-11	1	5-lug terminal strip, one mounting foot	346-1	1	Small sleeving
431-19	1	5-lug terminal strip, two mounting feet	346-6	1	Large sleeving
(18) 431-23	1	Terminal board	<b>METAL PARTS</b>		
(19) 434-15	2	7-pin tube socket	90-235	1	Cabinet
434-16	1	9-pin tube socket	200-M445	1	Chassis
(20) 434-47	1	Pilot lamp socket	203-80F755-756-757		
(21) 434-23	1	Candelabra lamp socket		1	Front panel
<b>HARDWARE</b>			<b>MISCELLANEOUS</b>		
(22) 250-2	6	3-48 x 5/16" screw	46-3	1	Filter choke
(23) 250-8	2	#6 x 3/8" sheet metal screw	54-57	1	Power transformer
(24) 250-9	12	6-32 x 3/8" screw	(36) 56-26	3	Crystal diode
250-48	4	6-32 x 1/2" screw	211-15	1	Plastic handle
(25) 250-83	2	#10 x 1/2" sheet metal screw	261-9	4	Rubber feet
(26) 252-1	6	3-48 nut	407-85	1	Meter
(27) 252-3	14	6-32 nut	462-187	5	Knob
(28) 252-7	7	Control nut	490-5	1	Nut starter*
(29) 253-9	4	#8 flat steel washer	331-6		Solder
(30) 253-10	5	Control flat washer	595-562	1	Manual
(31) 254-1	13	#6 lockwasher			
(32) 254-4	7	Control lockwasher			
(33) 259-1	2	#6 solder lug			
(34) 259-10	1	Control solder lug			
(35) 427-3	2	Binding post base			

\*See inside of front cover.

## PROPER SOLDERING TECHNIQUES

Only a small percentage of customers find it necessary to return equipment for factory service. By far the largest portion of malfunctions in this equipment is due to poor or improper soldering.

If terminals are bright and clean and free of wax, frayed insulation and other foreign substances, no difficulty will be experienced in soldering. Correctly soldered connections are essential if the performance engineered into a kit is to be fully realized. If you are a beginner with no experience in soldering, a half hour's practice with some odd lengths of wire may be a worthwhile investment.

For most wiring, a 25 to 100 watt iron or its equivalent in a soldering gun is very satisfactory. A lower wattage iron than this may not heat the connection enough to flow the solder smoothly. Keep the iron tip clean by wiping it from time to time with a cloth.

### CHASSIS WIRING AND SOLDERING

1. Unless otherwise indicated, all wire used is the type with colored insulation (hookup wire). In preparing a length of hookup wire, 1/4" of insulation should be removed from each end unless directed otherwise in the assembly step.
2. To avoid breaking internal connections when stripping insulation from the leads of transformers or similar components, care should be taken not to pull directly on the lead. Instead, hold the lead with pliers while it is being stripped.
3. Leads on resistors, capacitors, and similar components are generally much longer than need be to make the required connections. In these cases, the leads should be cut to proper length before the part is installed. In general, the leads should be just long enough to reach their terminating points.

4. Wherever there is a possibility of bare leads shorting to other parts or to the chassis, the leads should be covered with insulating sleeving. Where the use of sleeving is specifically intended, the phrase "use sleeving" is included in the associated assembly step. In any case where there is the possibility of an unintentional short circuit, sleeving should be used. Extra sleeving is provided for this purpose.

5. Crimp or bend the lead (or leads) around the terminal to form a good joint without relying on solder for physical strength. If the lead is too large to allow bending or if the step states that it is not to be crimped, position it so that a good solder connection can still be made.

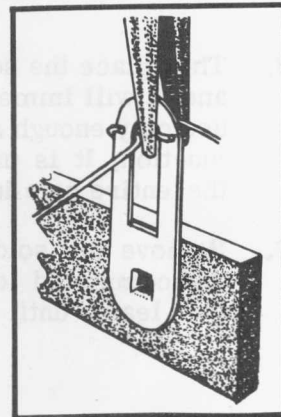

6. Position the work, if possible, so that gravity will help to keep the solder where you want it.

7. Place a flat side of the soldering iron tip against the joint to be soldered until it is heated sufficiently to melt the solder.

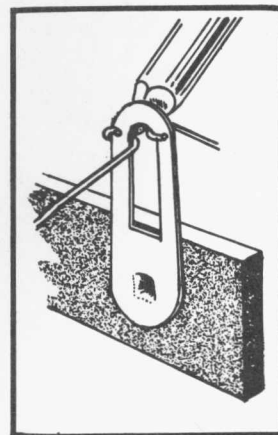

# PARTS PICTORIAL

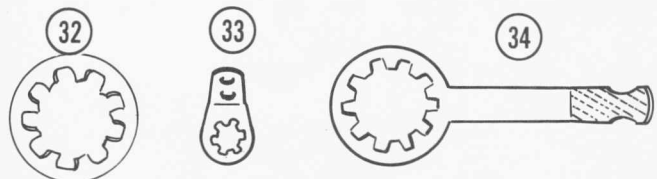
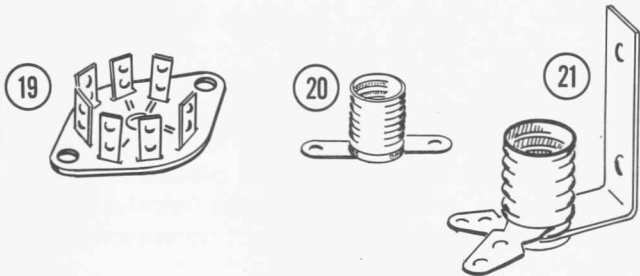
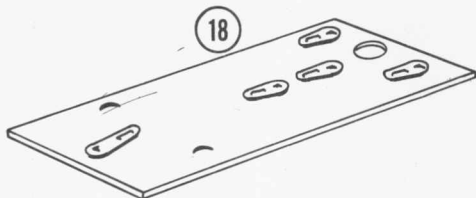
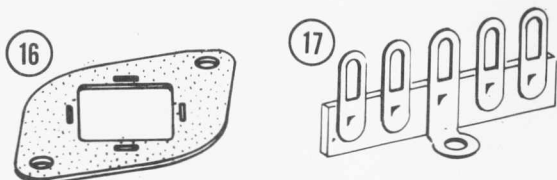
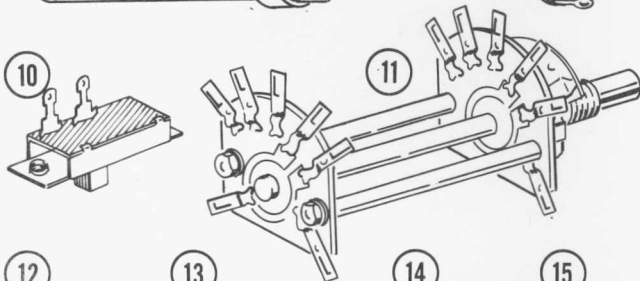
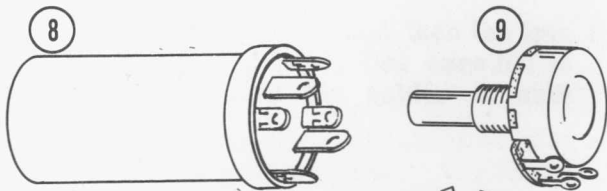
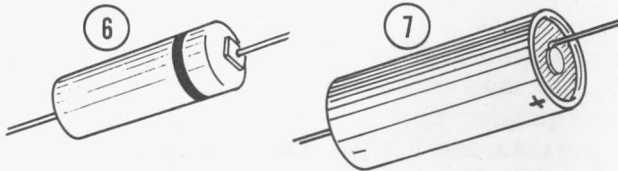
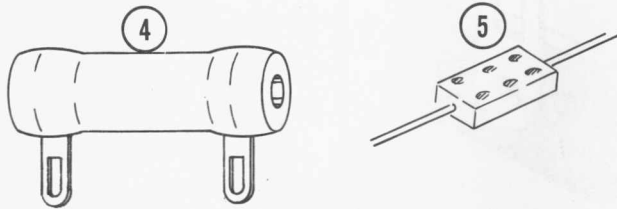
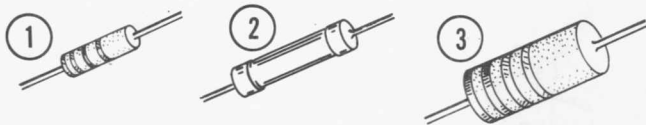



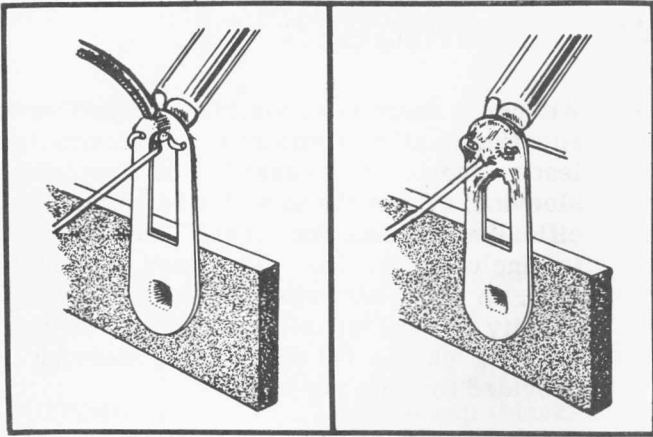

8. Then place the solder against the connection and it will immediately flow over the joint; use only enough solder to thoroughly wet the junction. It is usually not necessary to fill the entire hole in the terminal with solder.
9. Remove the solder and then the iron from the completed joint. Use care not to move the leads until the solder is solidified.

A poor or cold solder joint will usually look crystalline and have a grainy texture, or the solder will stand up in a blob and will not have adhered to the joint. Such joints should be reheated until the solder flows smoothly. In some cases, it may be necessary to add a little more solder to achieve a smooth, bright appearance.

ROSIN CORE SOLDER HAS BEEN SUPPLIED WITH THIS KIT. THIS TYPE OF SOLDER MUST BE USED FOR ALL SOLDERING IN THIS KIT. ALL GUARANTEES ARE VOIDED AND WE WILL NOT REPAIR OR SERVICE EQUIPMENT IN WHICH ACID CORE SOLDER OR PASTE FLUXES HAVE BEEN USED. IF ADDITIONAL SOLDER IS NEEDED, BE SURE TO PURCHASE ROSIN CORE (60:40 or 50:50 TIN-LEAD CONTENT) RADIO TYPE SOLDER.

## STEP-BY-STEP PROCEDURE

The following instructions are presented in a logical step-by-step sequence to enable you to complete your kit with the least possible confusion. Be sure to read each step all the way through before beginning the specified operation. Also read several steps ahead of the actual step being performed. This will familiarize you with the relationship of the subsequent operations. When the step is completed, check it off in the space provided. This is particularly important as it may prevent errors or omissions, especially if your work is interrupted. Some kit builders have also found it helpful to mark each wire and part in colored pencil on the Pictorial as it is added.

### ILLUSTRATIONS

The fold-out diagrams in this manual may be removed and attached to the wall above your working area; but because they are an integral part of the instructions, they should be returned to the manual after the kit is completed.

In general, the illustrations in this manual correspond to the actual configuration of the kit; however, in some instances the illustrations may be slightly distorted to facilitate clearly showing all of the parts.

### SOLDERING

The abbreviation "NS" indicates that a connection should not be soldered yet as other wires will be added. When the last wire is installed, the terminal should be soldered and the abbreviation "S" is used to indicate this. Note that a number will appear after each solder instruction. This number indicates the number of leads that are supposed to be connected to the terminal in point before it is soldered. For example, if the instruction reads, "Connect a wire to lug 1 (S-2)," it will be understood that there will be two wires connected to the terminal at the time it is soldered. (In cases where a wire passes through a terminal or lug and then connects to another point, it will count as two wires, one entering and one leaving the terminal.)

## STEP-BY-STEP ASSEMBLY

## PARTS MOUNTING-CHASSIS

Refer to Pictorial 1 (fold-out from Page 11) for the following steps.

- ( ) Position the chassis on your work area as shown in the Pictorial.
- ( ) Install rubber grommets at HD, HE, and HF.
- ( ) Referring to Detail 1A, install a 9-pin tube socket at V2, using 3-48 x 5/16" screws and nuts. The socket must be mounted from the bottom of the chassis. Position the blank space of the socket as indicated by the arrow on the Pictorial.
- ( ) In a like manner, install 7-pin tube sockets at V1 and V3, using 3-48 x 5/16" screws and 3-48 nuts. Position the blank space of each socket as indicated by the arrows on the Pictorial.

NOTE: When mounting the following parts, lock-washers and nuts will be used with all screws, unless stated otherwise in the assembly steps. Consequently, the following steps will call out only the size and type of hardware to be used. For example, the phrase "Use 6-32 x 3/8" hardware" means to use 6-32 x 3/8" screws, #6 lockwashers, and 6-32 nuts.

- ( ) Referring to Detail 1B, install a 5-lug terminal strip (two mounting feet) at L. Use 6-32 x 3/8" hardware.
- ( ) Referring to Detail 1C, install a 600  $\Omega$  control (#10-34) at N, using a control lock-washer and a control nut. If there is a locating tab on this control, bend it inward (toward the control shaft) so it does not hit the chassis. Do not tighten the nut at this time.
- ( ) Referring to Detail 1C, install a 10 K $\Omega$  control (#10-8) at P, using a control lock-washer and a control nut. Position controls N and P as shown and tighten their control nuts.

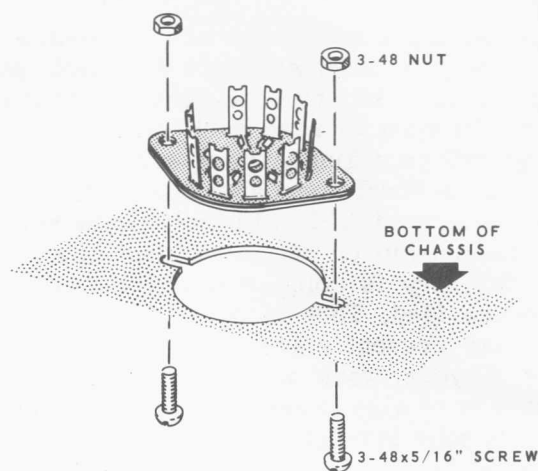

Detail 1A

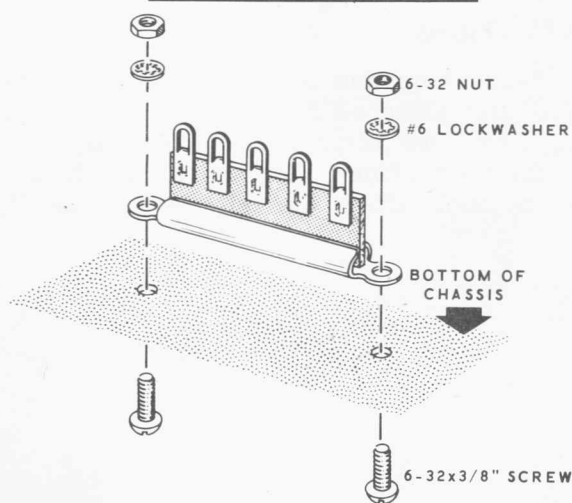

Detail 1B

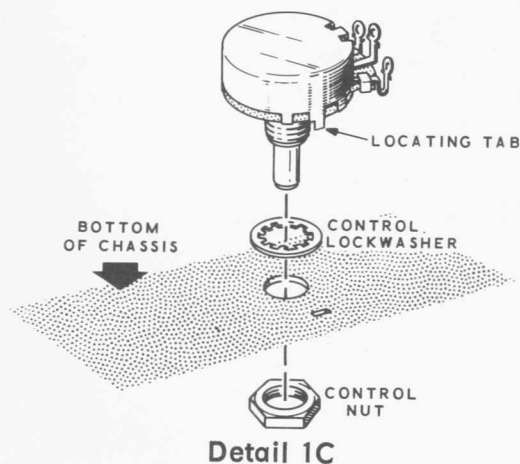

Detail 1C

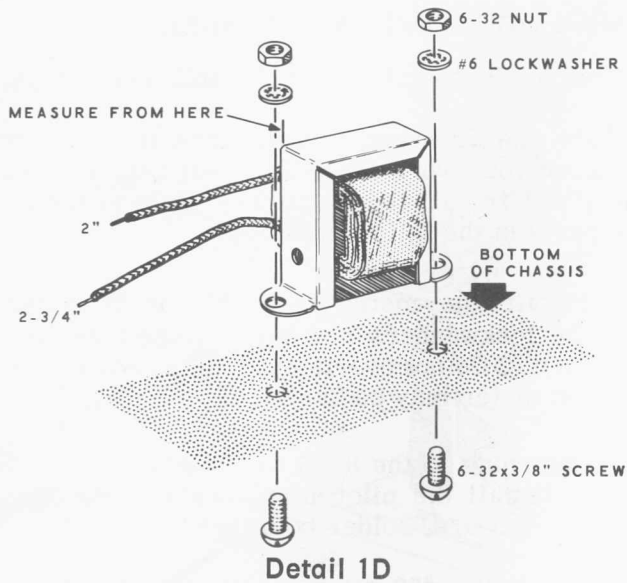

Detail 1D

( ) Referring to Detail 1E, locate the power transformer (#54-57) and cut the leads to the indicated lengths. Measure the leads from where they come out of the transformer. After cutting the leads to length, strip 1/4" insulation from the end of each lead and melt a small amount of solder on the exposed lead ends.

( ) Referring to Detail 1F, install the power transformer with a 5-lug terminal strip (one mounting foot) at S, using 6-32 x 3/8" hardware. The two black leads go through grommet HF and the remaining leads go through grommet HE. Position the terminal strip as shown.

( ) Referring to Detail 1D, locate the filter choke (#46-3) and cut the leads to the indicated lengths. Measure the leads from where they come out of the choke. Strip 1/4" insulation from the end of each lead and melt a small amount of solder on the exposed lead ends.

( ) Referring to Detail 1D, install the filter choke, using 6-32 x 3/8" hardware. Position the choke as shown.

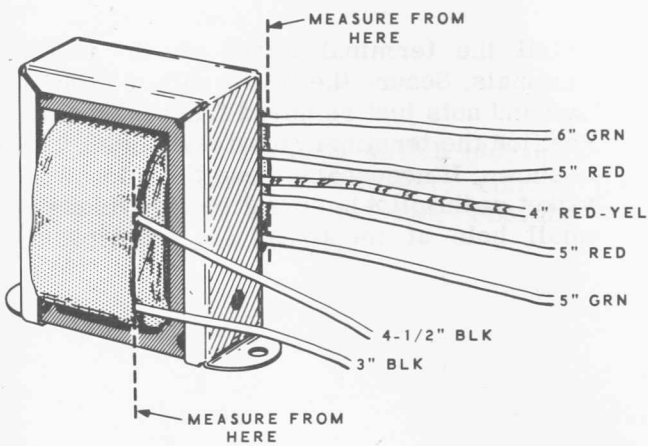

Detail 1E

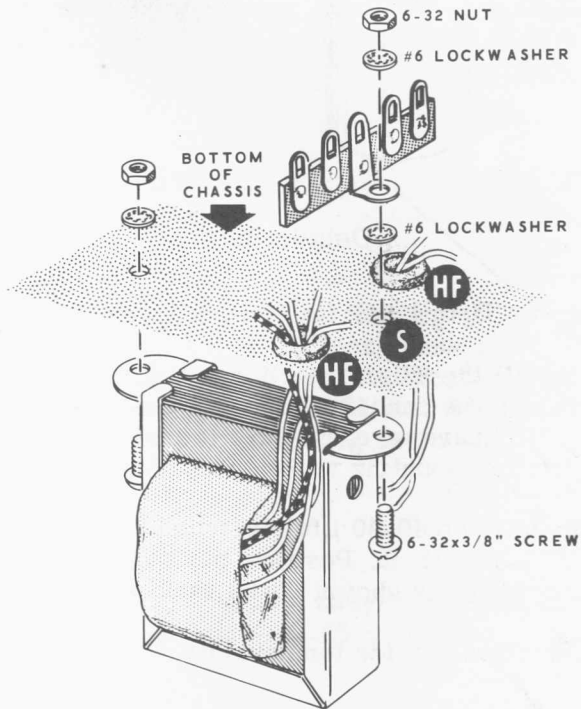

Detail 1F

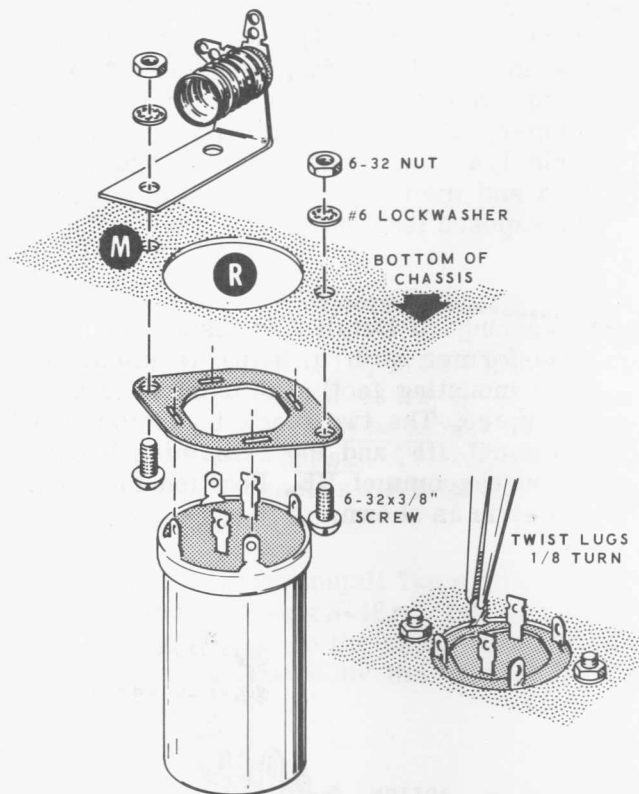

Detail 1G

Refer to Detail 1G for the following steps.

- ( ) Install the filter capacitor mounting wafer at R with the candelabra socket at M. Use 6-32 x 3/8" hardware. Be sure to install the capacitor mounting wafer on top of the chassis.
- ( ) Install the 40-40  $\mu$ fd electrolytic capacitor (#25-37) at R. Position the capacitor lug markings as shown. Twist the lugs 1/8 turn.

Set the chassis aside temporarily.

## PARTS MOUNTING-FRONT PANEL

Refer to Pictorial 2 for the following steps.

Locate the front panel and place it on a soft cloth on your work area. This will help prevent the panel from being scratched while mounting the parts in the following steps.

- ( ) Install the meter (#407-85) at B, using the lockwashers and nuts supplied with the meter. Do not overtighten this hardware as the meter may be damaged.
- ( ) Referring to the inset drawing on Pictorial 2, install the pilot lamp socket on the terminal board. Solder both lugs.
- ( ) Install the #50 pilot lamp in the pilot lamp socket.
- ( ) Place the large sleeving over the pilot lamp and the socket.
- ( ) Remove the shorting wire from between the meter terminals.
- ( ) Very carefully remove one nut and a solder lug from each meter terminal. It may be necessary to hold the bottom (front) nut with pliers to prevent loosening the meter terminals.
- ( ) Install the terminal board on the meter terminals. Secure the board with the solder lugs and nuts just removed from the meter. Position the terminal board and solder lugs as shown. If necessary, bend the pilot lamp socket so the pilot lamp is directly behind the small hole at the top of the front panel.

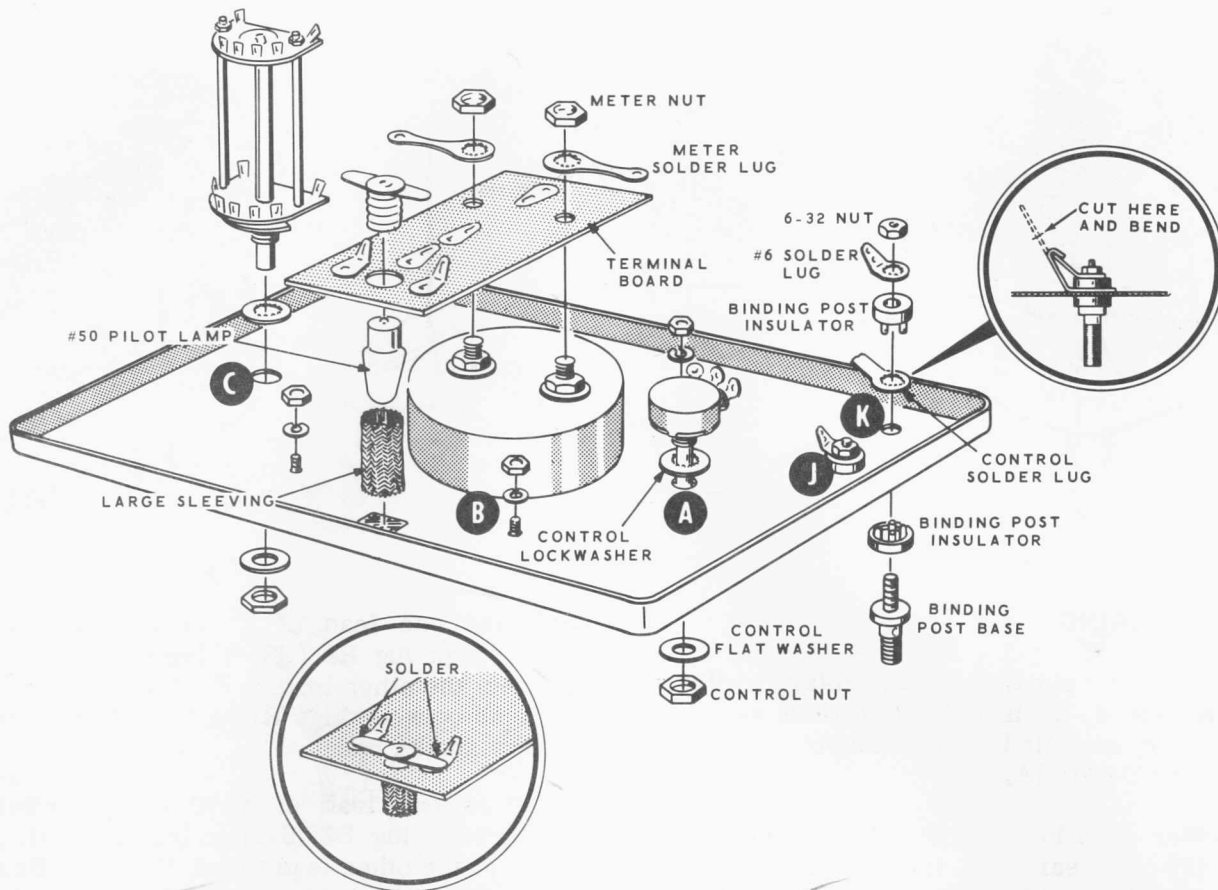

PICTORIAL 2

- (✓) Install a 5000  $\Omega$  control (#10-7) at A, using a control lockwasher, control flat washer, and a control nut. Position the control lugs as shown.
- (✓) Referring to the inset drawing of Pictorial 2, install a binding post base at K. Use binding post insulators, a control solder lug, #6 solder lug, and a 6-32 nut. Bend and cut off the control solder lug as shown.
- (✓) Install the 4-position switch (#63-8) at C. Use a control lockwasher, control flat washer, and a control nut. Position the switch lugs as shown.
- (✓) Install a binding post base at J, using binding post insulators, #6 solder lug, and a 6-32 nut.

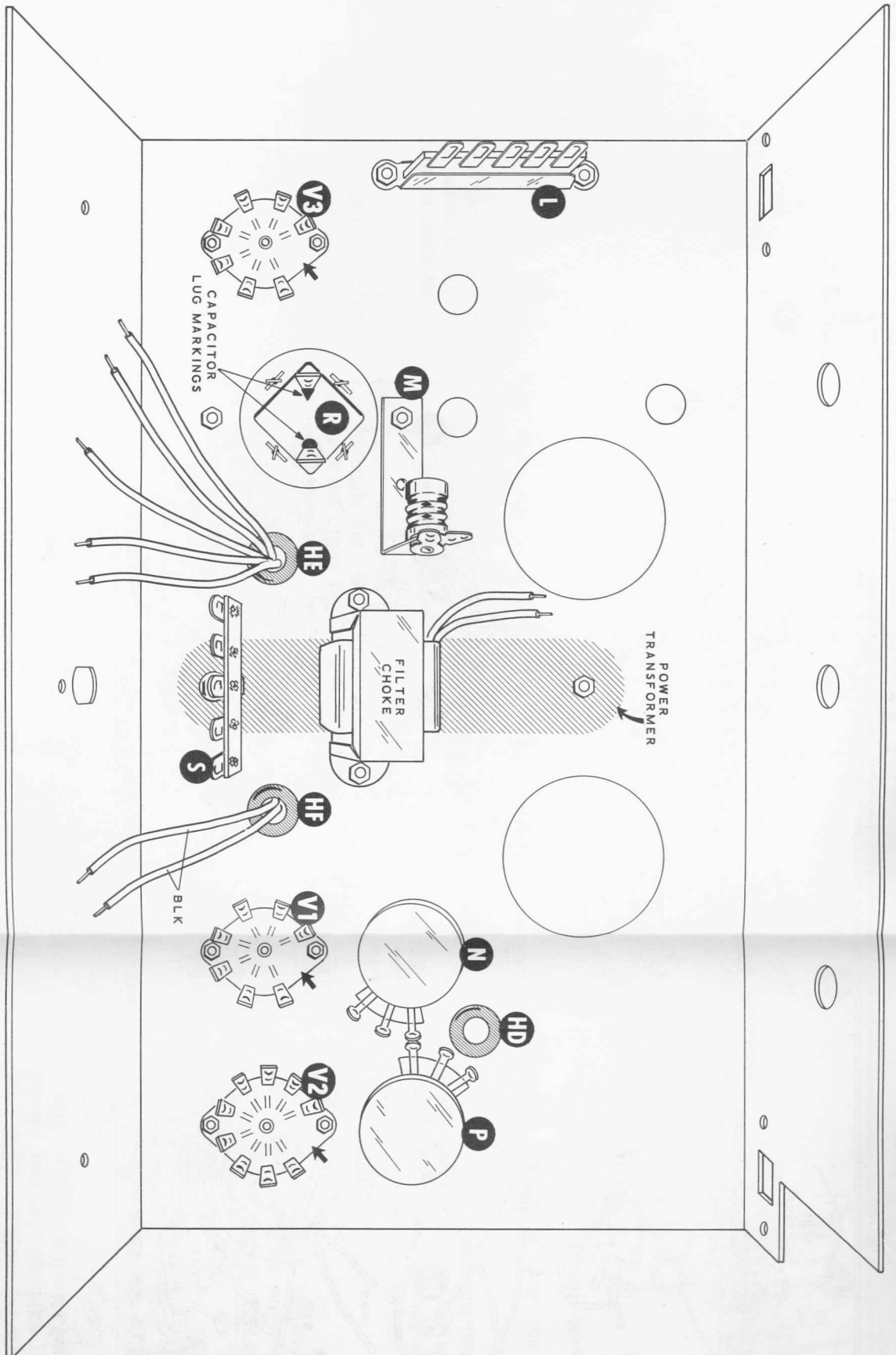

PICTORIAL 1

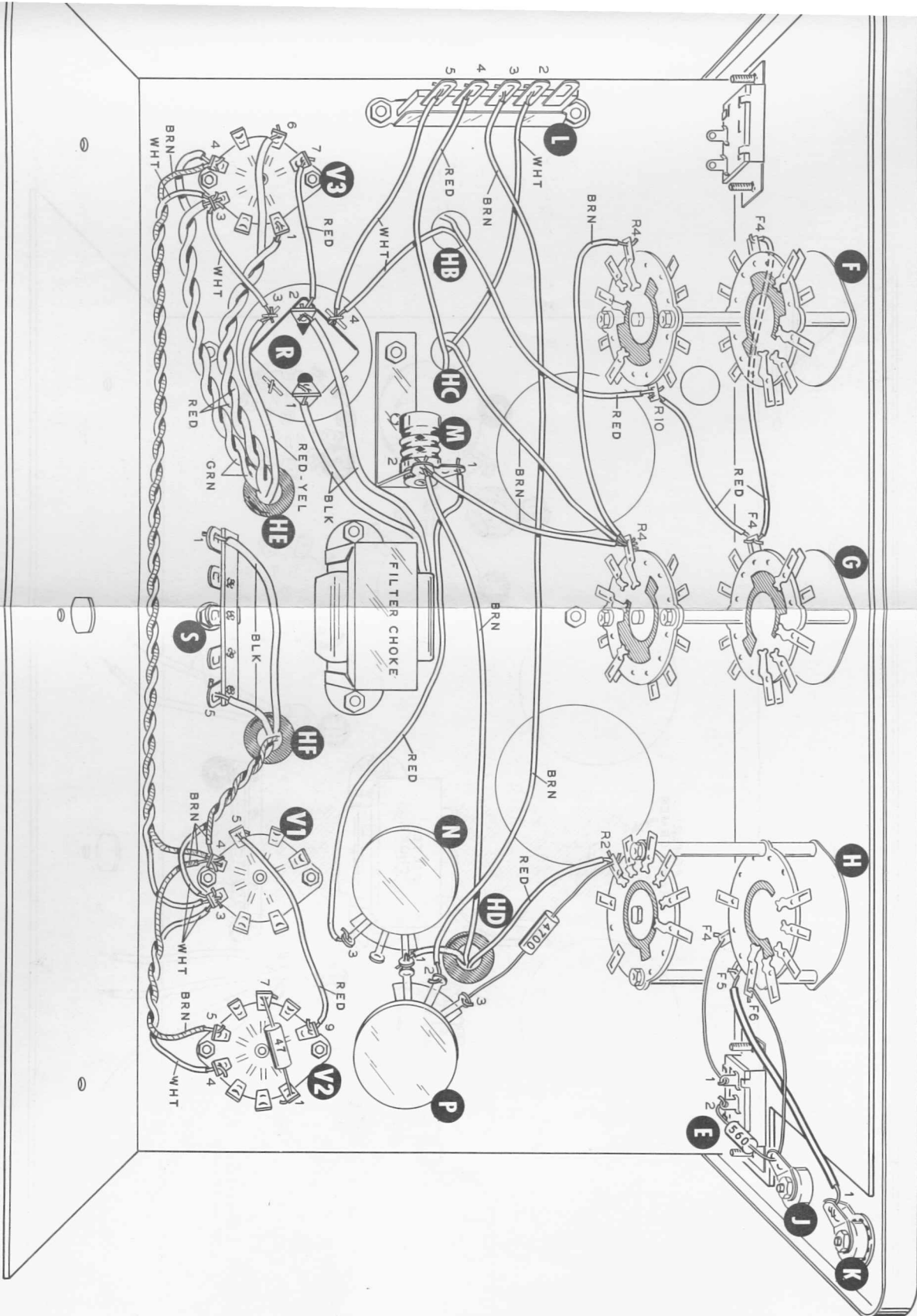

PICTORIAL 4

1 1A1907DM



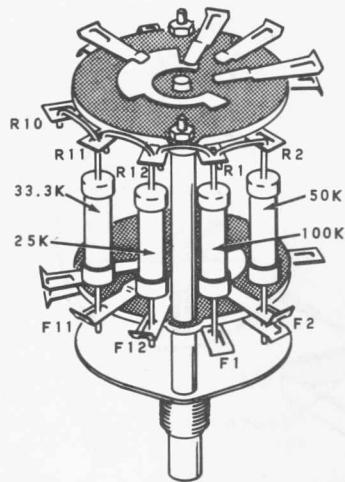

Detail 3A

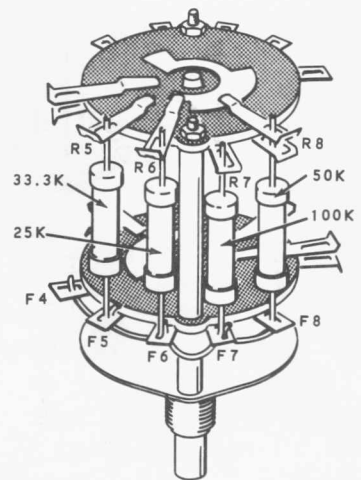
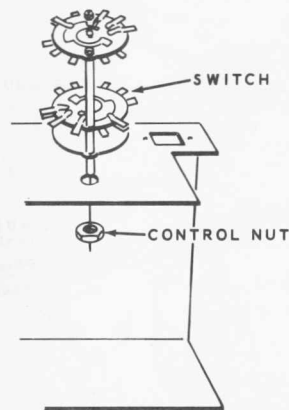

Detail 3B

### SWITCH WIRING

In the following six Details, the rotary switches will be wired. It is helpful if each switch is temporarily installed on the chassis while being wired. See Detail 3A.

The letter on a lug identifies the switch wafer, front (F) or rear (R), the number identifies the lug on that wafer. Where there is a lug on both sides of a wafer at one location, the connection should be made to both lugs. All switch positions (holes) do not have lugs, but are numbered to keep lug numbering consistent.

Refer to Detail 3A for the following steps.

- (✓) Locate an 11-position switch (#63-108) and be sure the shaft is rotated full counter-clockwise when looking at the shaft (front) end. Position the switch as shown.

NOTE: All resistors are 1/2 watt unless otherwise specified.

- (✓) Pass one lead of a 33.3 K $\Omega$  1% resistor through lug R11 (NS) to lug R10 (NS). Connect the other lead to lug F11 (S-1).
- (✓) Pass one lead of a 25 K $\Omega$  1% resistor through lug R12 (NS) to lug R11 (S-3). Connect the other lead to lug F12 (S-1).

- (✓) Pass one lead of a 100 K $\Omega$  1% resistor through lug R1 (NS) to lug R12 (S-3). Connect the other lead to F1 (S-1). Be sure the lead between lugs R1 and R12 does not touch the switch bolt.

- (✓) Pass one lead of a 50 K $\Omega$  1% resistor through lug R2 (S-2) to lug R1 (S-3). Connect the other lead to lug F2 (S-1). Be sure to solder both lugs at F2.

Refer to Detail 3B for the following steps.

- (✓) Position the switch as shown in the Detail.
- (✓) Pass one lead of a 33.3 K $\Omega$  1% resistor through lug F5 (NS) to lug F4 (NS). Connect the other lead to lug R5 (S-1).
- (✓) Pass one lead of a 25 K $\Omega$  1% resistor through lug F6 (NS) to lug F5 (S-3). Connect the other lead to lug R6 (S-1).
- (✓) Pass one lead of a 100 K $\Omega$  1% resistor through lug F7 (NS) to lug F6 (S-3). Connect the other lead to lug R7 (S-1). Be sure the lead between lugs F6 and F7 does not touch the switch bolt.
- (✓) Pass one lead of a 50 K $\Omega$  1% resistor through lug F8 (S-2) to lug F7 (S-3). Connect the other lead to lug R8 (S-1). Be sure both lugs at R8 are soldered.

Set this switch aside temporarily.

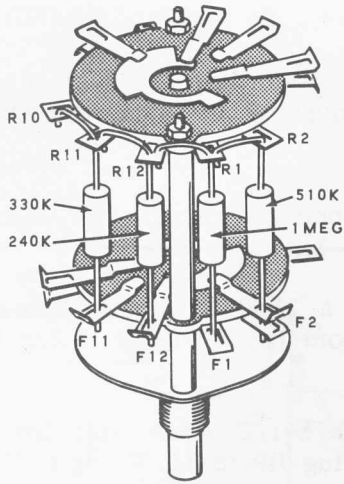

Detail 3C

Refer to Detail 3C for the following steps.

- ( ) Locate the remaining 11-position switch (#63-108) and rotate the shaft fully counter-clockwise when looking at the shaft (front) end. Position the switch as shown by the position of the rotor.
- ( ) Pass one lead of a 330 KΩ (orange-orange-yellow) resistor through lug R11 (NS) to lug R10 (NS). Connect the other lead to lug F11 (S-1).
- ( ) Pass one lead of a 240 KΩ (red-yellow-yellow) resistor through lug R12 (NS) to lug R11 (S-3). Connect the other lead to lug F12 (S-1).
- ( ) Pass one lead of a 1 megohm (brown-black-green) resistor through lug R1 (NS) to lug R12 (S-3). Connect the other lead to lug F1 (S-1). Be sure the lead between lugs R1 and R12 does not touch the switch bolt.
- ( ) Pass one lead of a 510 KΩ (green-brown-yellow) resistor through lug R2 (S-2) to lug R1 (S-3). Connect the other lead to lug F2 (S-1). Be sure both lugs at F2 are soldered.

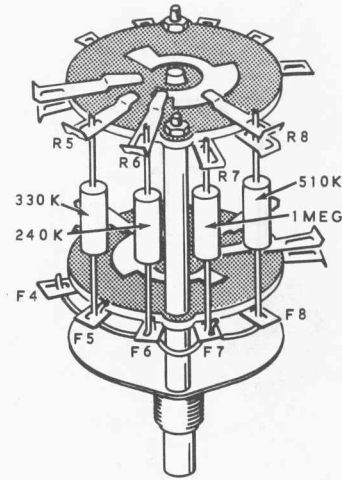

Detail 3D

Refer to Detail 3D for the following steps.

- ( ) Position the switch as shown in the Detail.
- ( ) Pass one lead of a 330 KΩ (orange-orange-yellow) resistor through lug F5 (NS) to lug F4 (NS). Connect the other end to lug R5 (S-1).
- ( ) Pass one lead of a 240 KΩ (red-yellow-yellow) resistor through lug F6 (NS) to lug F5 (S-3). Connect the other lead to lug R6 (S-1).
- ( ) Pass one lead of a 1 megohm (brown-black-green) resistor through lug F7 (NS) to lug F6 (S-3). Connect the other lead to lug R7 (S-1). Be sure the lead between lugs F6 and F7 does not touch the switch bolt.
- ( ) Pass one lead of a 510 KΩ (green-brown-yellow) resistor through lug F8 (S-2) to lug F7 (S-3). Connect the other lead to lug R8 (S-1). Be sure both lugs at R8 are soldered.

Set this switch aside temporarily.

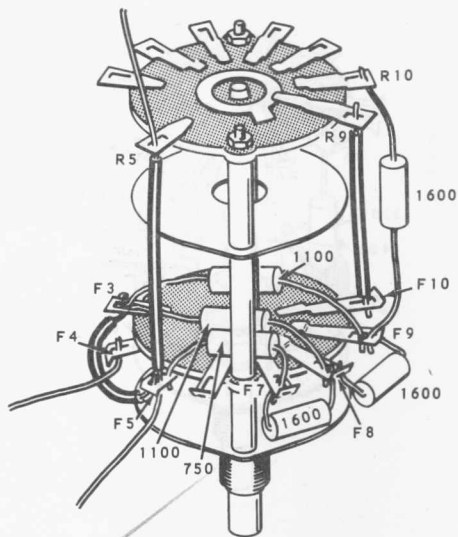

Detail 3E

Refer to Detail 3E for the following steps.

- ( ) Locate the 8-position switch (#63-107) and rotate the shaft fully counterclockwise when looking at the shaft (front) end. Position the switch as shown.

NOTE: When both leads of a resistor are connected to the same wafer, position the body of the resistor so it does not touch the switch.

- ( ) Connect a 750  $\Omega$  (violet-green-brown) resistor between lugs F5 (NS) and F7 (NS). Position the resistor as shown.
- ( ) Pass one lead of an 1100  $\Omega$  (brown-brown-red) resistor through lug F3 (NS) to lug F5 (NS). Place a 5/8" length of sleeving on the lead between lugs F3 and F5. Connect the other lead to lug F8 (NS).
- ( ) Connect an 1100  $\Omega$  (brown-brown-red) resistor between lugs F3 (S-3) and F9 (NS).
- ( ) Connect a 1600  $\Omega$  (brown-blue-red) resistor between lugs F7 (S-2) and F8 (NS).

- ( ) Connect a 1600  $\Omega$  (brown-blue-red) resistor between lugs F8 (S-3) and F9 (NS).

NOTE: In steps calling for only one end of a wire to be connected, the other end will be connected later.

- ( ) Connect one end of a 1-1/4" bare wire to lug F4 (S-1).
- ( ) Connect a 1600  $\Omega$  (brown-blue-red) resistor from lug F9 (S-3) to lug R10 (NS).
- ( ) Connect a 1-1/2" bare wire from lug F10 (S-1) to lug R9 (S-1). Place a 1" length of sleeving on this wire.
- ( ) Pass a 4-1/2" bare wire through lug R5 (NS) and through lug F5 (S-4). This wire should extend 1-1/2" from lug F5 and 1-5/8" from lug R5. Use a 1" length of sleeving between lugs F5 and R5.

Refer to Detail 3F for the following steps.

- ( ) Pass one lead of an 1100  $\Omega$  (brown-brown-red) resistor through lug R5 (S-4) to lug R3 (NS). Connect the other lead to lug R10 (NS).

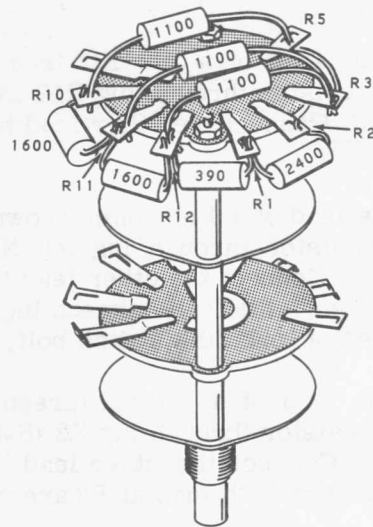

Detail 3F

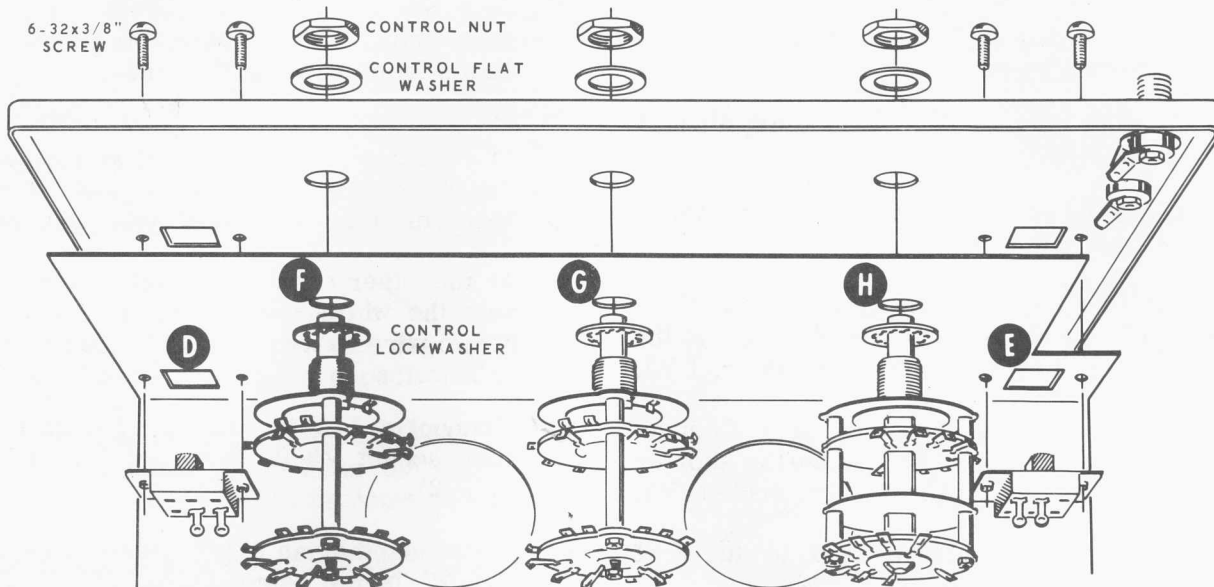

PICTORIAL 3

- ( ) Connect an 1100  $\Omega$  (brown-brown-red) resistor between lugs R3 (NS) and R12 (NS). Keep the resistor clear of the rotor and the lead clear of the switch bolt.
- ( ) Connect an 1100  $\Omega$  (brown-brown-red) resistor between lugs R3 (S-3) and R11 (NS). Keep the resistor clear of the rotor.
- ( ) Connect a 2400  $\Omega$  (red-yellow-red) resistor between lugs R1 (NS) and R2 (NS).
- ( ) Connect a 390  $\Omega$  (orange-white-brown) resistor between lugs R1 (S-2) and R12 (NS).
- ( ) Connect a 1600  $\Omega$  (brown-blue-red) resistor between lugs R11 (NS) and R12 (S-3).
- ( ) Connect a 1600  $\Omega$  (brown-blue-red) resistor between lugs R10 (S-3) and R11 (S-3).

Set this switch aside temporarily.

Refer to Pictorial 3 and to Pictorial 4 (fold-out from Page 12) for the following steps.

- ( ) Install the front panel on the chassis with SPST slide switches at D and E. Use 6-32 x 3/8" screws. Position the switch lugs as shown. Be sure the three remaining front panel and chassis holes line up properly before tightening the switch screws.
- ( ) Install switch F (11-position switch with 1% resistors) on the chassis. Use a control lockwasher, control flat washer, and a control nut. Position the switch with the lugs as shown in Pictorial 4.
- ( ) In a like manner, install switch G (remaining 11-position switch) on the chassis. Use a control lockwasher, control flat washer, and a control nut. Position the switch as shown in Pictorial 4.
- ( ) Install switch H (8-position switch) on the chassis. Use a control lockwasher, control flat washer, and a control nut. Position the switch as shown in Pictorial 4.

## WIRING-CHASSIS BOTTOM

Refer to Pictorial 4 (fold-out from Page 12) for the following steps.

- (✓) Bend the lugs of the three tube sockets outward slightly as shown.

Connect the power transformer leads coming from grommet HE as follows:

- (✓) Twist together the two green leads. Connect the longer lead to lug 4 (NS) and the shorter lead to lug 3 (NS) of tube socket V3.
- (✓) Twist together the two red leads. Connect the longer lead to lug 6 (S-1) and the shorter lead to lug 1 (S-1) of tube socket V3.
- (✓) Connect the red-yellow lead to lug 3 of capacitor R (NS).

Connect the power transformer leads coming from grommet HF to terminal strip S, as follows:

- (✓) Shorter black to lug 5 (NS).
- (✓) Longer black to lug 1 (NS).

Connect the filter choke leads to capacitor R as follows:

- (✓) Shorter black to lug 1 (NS).
- (✓) Longer black to lug 2 (NS).
- (✓) Referring to Detail 4A, twist together a 7" brown and a 7" white wire to obtain about two turns per inch. Strip 1/4" insulation from all four wire ends.

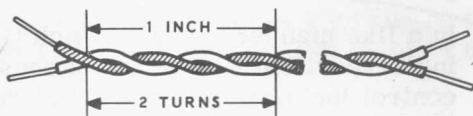

Detail 4A

- (✓) At either end of the twisted wires, connect the white wire to lug 3 (NS) and the brown wire to lug 4 (S-2) of tube socket V3.
- (✓) At the other end of the twisted wires, connect the white wire to lug 3 (NS) and the brown wire to lug 4 (NS) of tube socket V1.

- (✓) In a like manner, twist together a 3" white wire and 3" brown wire. Strip 1/4" insulation from all four wire ends.

- (✓) At either end of the twisted wires, connect the white wire to lug 3 (NS) and the brown wire to lug 4 (NS) of tube socket V1.

- (✓) At the other end of the twisted wires, connect the white wire to lug 4 (S-1) and the brown wire to lug 5 (S-1) of tube socket V2.

- (✓) Connect a 1-3/4" white wire from lug 3 of tube socket V3 (S-3) to lug 3 of capacitor R (S-2).

- (✓) Twist together an 8-1/2" white wire and an 8-1/2" brown wire. Strip 1/4" insulation from all four wire ends.

- (✓) At either end of the twisted wires, connect the white wire to lug 3 (S-3) and the brown wire to lug 4 (S-3) of tube socket V1. Pass the other end of the twisted wires through grommet HF to be connected later.

To facilitate wiring in the following steps, pre-cut the wires to the lengths listed at the beginning of each section. Remove 1/4" of insulation from each end of the wires and lay them in the sequence listed for quick identification.

- (✓) Prepare the following lengths of hookup wire:

2-3/4" white	2" red
4" white	3-1/2" white
5" red	5" red
7" white	7-1/2" brown

- (✓) Connect a 2-3/4" white wire from lug 5 of terminal strip L (NS) to lug 4 of capacitor R (NS).

- (✓) Connect one end of a 4" white wire to lug 4 of capacitor R (S-2). Pass the other end of the wire through hole HB to be connected later.

- ( ) Connect one end of a 5" red wire to lug 4 of terminal strip L (NS). Pass the other end of the wire through hole HC to be connected later.
- ( ) Connect one end of a 7" white wire to lug 2 of terminal strip L (NS). Pass the other end of the wire through hole HC to be connected later.
- ( ) Connect a 2" red wire from lug 7 of tube socket V3 (S-1) to lug 2 of capacitor R (S-2).
- ( ) Connect one end of a 3-1/2" white wire to lug 1 of control N (NS). Pass the other end through grommet HD to be connected later.
- ( ) Connect a 5" red wire from lug 1 of candelabra socket M (S-1) to lug 3 of control N (NS).
- ( ) Connect one end of a 7-1/2" brown wire to lug 2 of candelabra socket M (NS). Pass the other end through grommet HD to be connected later.
- ( ) Prepare the following lengths of hookup wire:
- |            |              |
|------------|--------------|
| 8" brown   | 4" brown     |
| 2-1/2" red | 1-1/2" brown |
| 3" red     | 5" red       |
| 2" red     | 4-1/4" red   |
| 3" brown   |              |
- ( ) Connect an 8" brown wire from lug 3 of terminal strip L (NS) to lug 2 of control P (S-1).
- ( ) Connect a 2-1/2" red wire from lug 5 of tube socket V1 (S-1) to lug 9 of tube socket V2 (S-1).
- ( ) Connect a 3" red wire from lug F4 of switch F (S-2) to lug F4 of switch G (NS). Position the wire as shown, keeping it clear of the rotor and shaft of the switch.
- ( ) Connect a 2" red wire from lug R10 of switch F (NS) to lug F4 of switch G (S-3).
- ( ) Connect a 3" brown wire from lug R4 of switch F (S-1) to lug R4 of switch G (NS). Be sure both lugs at R4 on switch F are soldered.
- ( ) Connect one end of a 4" brown wire to lug R4 of switch G (NS). Pass the other end through hole HC to be connected later.
- ( ) Connect a 1-1/2" brown wire from lug R4 of switch G (S-3) to lug 2 of candelabra socket M (NS). Be sure that both lugs at R4 on the switch are soldered.
- ( ) Connect one end of a 5" red wire to lug R10 (NS). Pass the other end through hole HB to be connected later.
- ( ) Place a 1" length of sleeving on the bare wire coming from lug F5 of switch H. Then connect this wire to solder lug K (S-1). Be sure the control solder lug is soldered to solder lug K.
- ( ) Connect the bare wire coming from lug F4 of switch H, to lug 1 of switch E (S-1).
- ( ) Pass one lead of a 560  $\Omega$  (green-blue-brown) resistor through solder lug J (S-2) to lug F6 of switch H (S-1). Connect the other lead to lug 2 of switch E (S-1).
- ( ) Connect a 4700  $\Omega$  (yellow-violet-red) resistor from lug R2 of switch H (NS) to lug 3 of control P (S-1).
- ( ) Connect one end of a 4-1/4" red wire to lug R2 of switch H (S-3). Pass the other end through grommet HD to be connected later.
- ( ) Connect a 47  $\Omega$  (yellow-violet-black) resistor between lugs 1 (S-1) and 7 (NS) of tube socket V2.

Refer to Pictorial 5 (fold-out from Page 19) for the following steps.

- ( ) Cut and twist together an 11" red wire and an 11" brown wire. Strip 1/4" insulation from all four wire ends.
- ( ) At either end of the twisted wires, connect the red wire to lug 1 (S-1) and the brown wire to lug 2 (S-1) of switch D.
- ( ) Position the twisted wires as shown and at the other end, connect the red wire to lug 2 (NS) and the brown wire to lug 5 (S-2) of terminal strip S.
- ( ) Prepare the following lengths of hookup wire.
 

5-1/2" white	3-3/4" white
7-1/4" red	3" white
3" red	4-1/2" white
- ( ) Strip 5/8" insulation from one end of a 5-1/2" white wire. Pass the end of this wire with the 5/8" insulation removed, through lug 2 (NS) to lug 1 (S-3) of control N. Connect the other end of the wire to lug 5 of capacitor R (S-1). Be sure lug 1 of controls N and P are soldered together.
- ( ) Place a 1-1/4" length of sleeving on the bare wire coming from lug R5 of switch H. Then pass the end of this wire through lug 1 of control P (NS) to lug 1 of control N (NS).
- ( ) Pass one lead of a 330  $\Omega$  (orange-orange-brown) resistor through lug 7 (S-2) to lug 2 (NS) of tube socket V1. Connect the other lead to lug 3 of control N (S-2). Position the lead between lugs 2 and 7 so it will not touch the tube pins when the tube is installed.
- ( ) Connect a 7-1/4" red wire from lug 1 of capacitor R (S-2) to lug 3 of tube socket V2 (NS).
- ( ) Connect a 3" red wire from lug R10 of switch F (S-4) to lug R10 of switch G (S-2).
- ( ) Connect one end of a 3-3/4" white wire to lug F10 of switch F (NS). Position the other end of the wire through hole HA to be connected later.
- ( ) Connect a 3" white wire from lug F10 of switch F (S-2) to lug F10 of switch G (NS). Keep the wire clear of the rotor and shaft of the switch. Be sure both lugs on switch F are soldered.
- ( ) Connect a 4-1/2" white wire from lug F10 of switch G (S-2) to lug 1 of tube socket V1 (S-1). Be sure that both lugs on the switch are soldered.
- ( ) Pass one lead of a 120 K $\Omega$  (brown-red-yellow) resistor through lug 8 (S-2) to lug 3 (NS) of tube socket V2. Place a 1" length of sleeving on the other lead and connect it to lug 6 of tube socket V1 (NS).
- ( ) Place a 1" length of sleeving on the positive (+) lead of a 16  $\mu$ fd 150 V electrolytic capacitor and connect this lead to lug 6 of tube socket V1 (S-2).
- ( ) Place a 1-1/2" length of sleeving on the other lead of this capacitor and connect it to lug 2 of tube socket V1 (S-2). Position the capacitor as shown.
- ( ) Pass one lead of a 47 K $\Omega$  (yellow-violet-orange) 2 watt resistor through lug 6 (S-2) to lug 3 (S-3) and the other lead to lug 2 (S-1) of tube socket V2.

- ( ) Cut both leads of a 5000  $\Omega$  20 watt resistor to 1". Place a 3/4" length of sleeving on each lead.
- ( ) Connect this resistor from lug 2 of control N (S-3) to lug 7 of tube socket V2 (NS). Position this resistor as shown in inset drawing #1 on Pictorial 5.
- ( ) Connect a 2000  $\Omega$  (red-black-red) resistor between lugs 1 (NS) and 4 (NS) of terminal strip L.
- ( ) Connect a 10 K $\Omega$  (brown-black-orange) resistor between lugs 4 (NS) and 5 (NS) of terminal strip L.
- ( ) Connect a 10 K $\Omega$  (brown-black-orange) resistor between lugs 2 (NS) and 5 (S-3) of terminal strip L.

Refer to inset drawing #2 on Pictorial 5 for the following steps.

NOTE: Crystal diodes will be connected in the following steps. Do not shorten the diode leads.

- ( ) Connect the lead at the banded end of a crystal diode to lug 1 (S-2) and the other lead to lug 2 (NS) of terminal strip L.
- ( ) Connect the lead at the banded end of a crystal diode to lug 2 (S-4) and the other lead to lug 3 (NS) of terminal strip L.

- ( ) Connect the lead at the banded end of a crystal diode, to lug 3 (S-3) and the other lead to lug 4 (S-4) of terminal strip L.

Position all three diodes as shown so they will not touch the cabinet when it is installed later.

- ( ) Locate the line cord. Twist the end strands of each lead together and melt a small amount of solder on the exposed lead ends.
- ( ) Pass the end of the line cord through hole HG. Connect either wire to lug 1 (S-2) and the other wire to lug 2 (S-2) of terminal strip S.
- ( ) Referring to Detail 5A, install the line cord strain relief in hole HG.

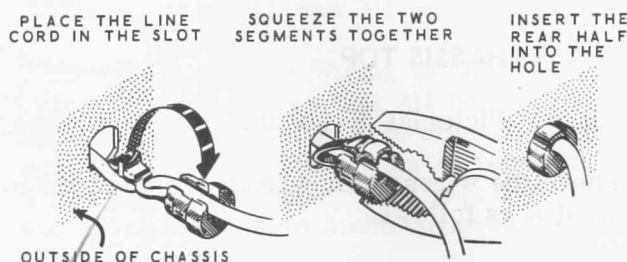

Detail 5A

- ( ) Place a 2" length of sleeving on each lead of a 20  $\mu$ fd 350 V electrolytic capacitor. Connect the positive (+) lead to lug 7 of tube socket V2 (S-3) and the other lead to lug 2 of candelabra socket M (S-3). Position the capacitor as shown.
- ( ) Install the 3 watt candelabra lamp in socket M.





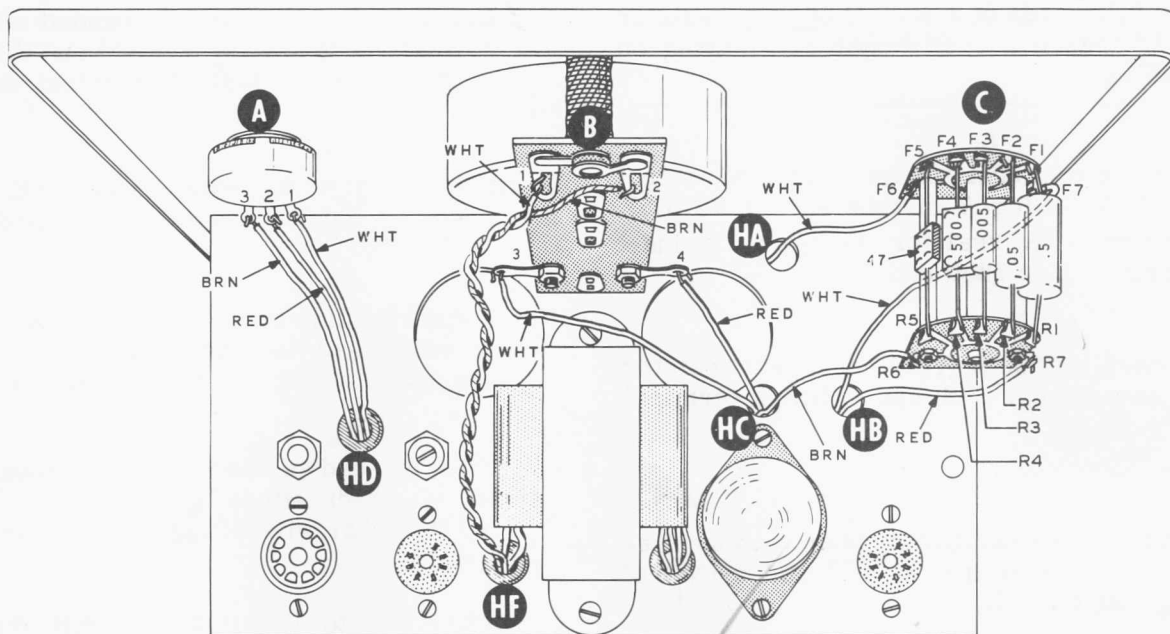

PICTORIAL 6

**WIRING-CHASSIS TOP**

Refer to Pictorial 6 for the following steps.

Connect the wires coming from grommet HD to control A as follows:

- ( ) Brown, coming from lug 2 of candelabra socket M, to lug 3 (S-1).
- ( ) Red, coming from lug R2 of switch H, to lug 2 (S-1).
- ( ) White, coming from lug 1 of control N, to lug 1 (S-1).

Connect the wires coming from hole HC as follows:

- ( ) White, coming from lug 2 of terminal strip L, to lug 3 of terminal board B (S-1).

- ( ) Red, coming from lug 4 of terminal strip L, to lug 4 of terminal board B (S-1).

- ( ) Brown, coming from lug R4 of switch G, to lug R6 of switch C (S-1).

Connect the white and brown twisted wires coming from grommet HF, to terminal board B as follows:

- ( ) White to lug 1 (S-1).
- ( ) Brown to lug 2 (S-1).
- ( ) Connect the white wire extending from hole HA, coming from lug F10 of switch F, to lug F6 of switch C (S-1).

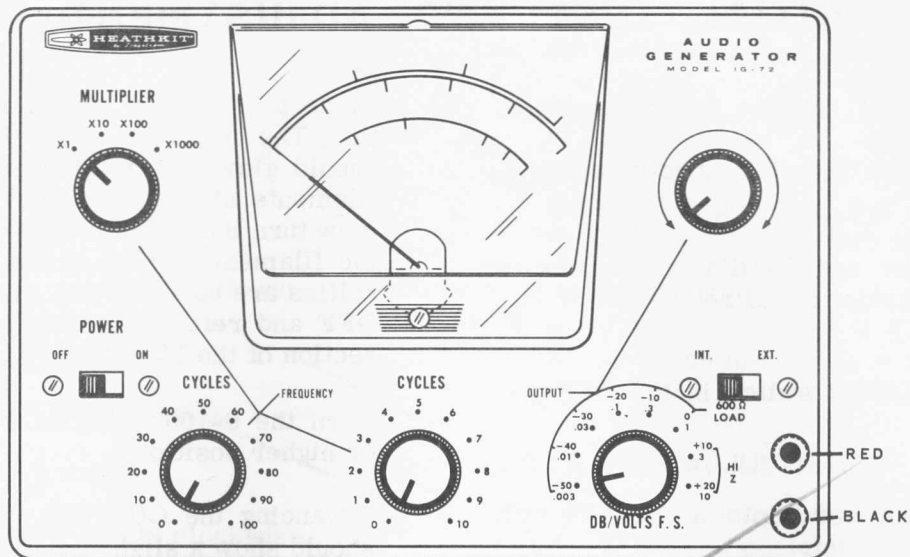

Detail 6A

Connect the wires coming from hole HB to switch C as follows:

- ( ) White, coming from lug 4 of capacitor R, to lug F7 (S-1).
- ( ) Red, coming from lug R10 of switch F, to lug R7 (S-1).
- ( ) Connect a 47  $\mu\text{mf}$  (yellow-violet-black) mica capacitor between lugs F5 (S-1) and R5 (S-1) of switch C.
- ( ) Connect a 500  $\mu\text{mf}$  (green-black-brown) mica capacitor between lugs F4 (S-1) and R4 (S-1) of switch C.
- ( ) Connect a .005  $\mu\text{fd}$  tubular capacitor between lugs F3 (S-1) and R3 (S-1) of switch C.
- ( ) Connect a .05  $\mu\text{fd}$  tubular capacitor between lugs F2 (S-1) and R2 (S-1) of switch C.
- ( ) Connect a .5  $\mu\text{fd}$  tubular capacitor between lugs F1 (S-1) and R1 (S-1) of switch C.

This completes the wiring of the Audio Generator. Check to see that all connections are soldered. Shake out any wire clippings or solder splashes. Note that two lugs on terminal strip S are not used. These extra lugs are provided for special wiring in Audio Generators shipped abroad.

- ( ) Referring to Detail 6A, install a knob on each of the front panel control and switch shafts. Turn each shaft to its fully counterclockwise position. Place the pointer of each knob to the most counterclockwise marking on the front panel. The knob setscrew on the Multiplier switch should be tightened against the flat of the shaft. If the pointer on the knob does not line-up properly with the panel markings, loosen the switch nut and reposition the switch. Retighten the nut.
- ( ) Install the red binding post cap on the upper binding post base.
- ( ) Install the black binding post cap on the lower binding post base.

## INITIAL TEST AND ADJUSTMENT

Refer to Figure 1 for the following steps.

- ( ) Install the tubes in their respective sockets.
- ( ) Set the Meter and Oscillator controls on top of the chassis to half rotation.
- ( ) Place the POWER switch in the OFF position.
- ( ) Plug the line cord into a 105-125 volt AC 50/60 cps outlet.
- ( ) Place the POWER switch in the ON position. The pilot lamp (at the top of the meter) should glow. After a few seconds, the tube filaments should also glow. If they do not glow turn the POWER switch OFF and check the filament circuit wiring. If other difficulties are encountered, turn the Generator OFF and refer to the In Case Of Difficulty section of the Manual.
- ( ) Turn the 0-100 CYCLES switch to the 10 or higher position.
- ( ) Advancing the OUTPUT control clockwise should show a slight indication on the meter.

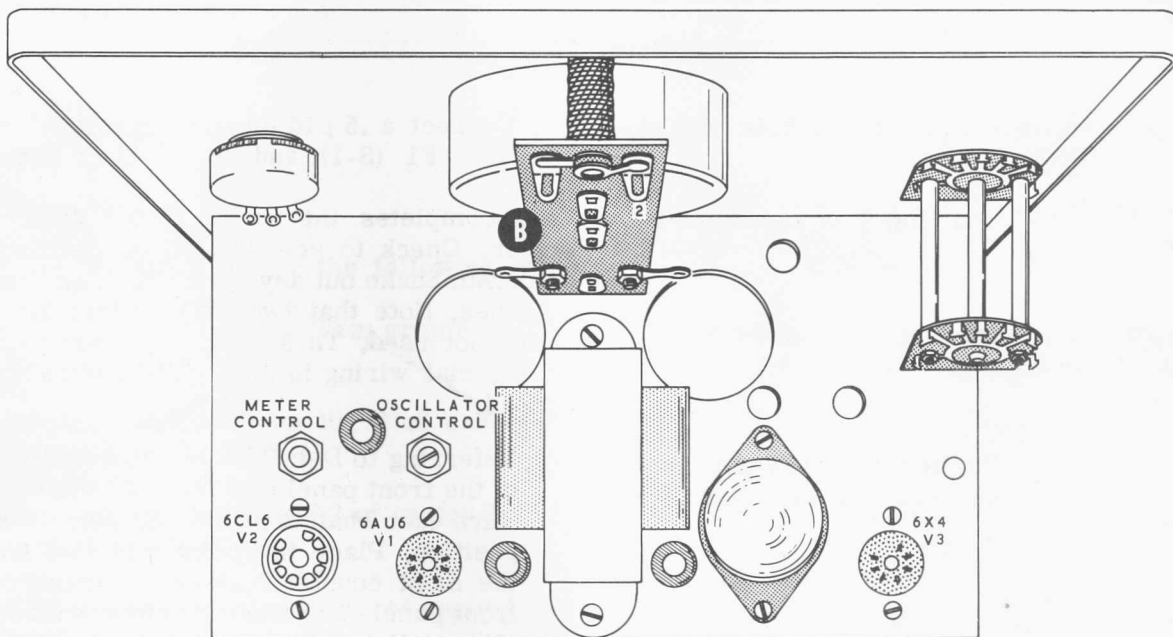

Figure 1

## METER CALIBRATION WITH AN AC VOLTMETER

NOTE: The AC voltmeter should have a sensitivity of at least 500  $\Omega$  per volt on the 10 volt scale.

Set the Generator controls as follows:

MULTIPLIER switch - X1.

0-100 CYCLES switch - 100.

0-10 CYCLES switch - 0.

OUTPUT control - fully clockwise.

DB/VOLTS switch - fully clockwise (10).

- ( / ) Connect the AC voltmeter to the Generator Output binding posts.
- ( / ) Adjust the Generator Meter control (on top of the chassis) so the AC voltmeter and Generator meters read the same.
- ( / ) Disconnect the AC voltmeter from the Generator.

## METER CALIBRATION WITHOUT AN AC VOLTMETER

Set the Generator controls to the following positions:

MULTIPLIER - X1.

Both CYCLES switches - 0.

OUTPUT control - Fully clockwise.

DB/VOLTS switch - Fully clockwise (10).

CAUTION: Do not turn the OUTPUT control during the following adjustments. If it is not in the fully clockwise position, it may be damaged as the following adjustments are performed.

- ( / ) Connect a wire between the red (top) Output binding post and lug 2 (brown wire) of the pilot lamp socket on terminal board B.
- ( / ) Adjust the Meter control (on top of chassis) to obtain a reading of 6.3 on the 0 to 10 scale of the meter. Then remove the wire.

## OSCILLATOR ADJUSTMENT

Be sure all leads have been disconnected from the Output binding posts of the Generator. Then set the Generator controls as follows:

MULTIPLIER - X1.

0-100 CYCLES - 10.

0-10 CYCLES - 0.

OUTPUT control - fully clockwise.

DB/VOLTS switch - fully clockwise.

- ( / ) Adjust the Oscillator control (on top of the chassis) for a slightly higher than full scale (10 on the 0-10 scale) meter reading.
- ( / ) Move the MULTIPLIER switch through the X10, X100, and X1000 positions. The meter should not indicate less than full scale on any of these ranges. If the meter indicates less than full scale, readjust the Oscillator control for a full scale (10 volts) meter reading. With the Oscillator control properly adjusted, the meter should indicate no less than full scale on each setting of the MULTIPLIER switch. A higher than normal output level on any range will cause distortion in the Generator output signal.

This completes the adjustments of the Generator.

## FINAL ASSEMBLY

Refer to Pictorial 7 for the following steps.

- ( ) Install the four rubber feet on the cabinet, using #8 flat washers and 6-32 x 3/8" hardware.
- ( ) Install the handle on the cabinet, using #10 x 1/2" sheet metal screws.
- ( ) Pass the line cord through the hole in the rear of the cabinet. Install the Generator in the cabinet, using #6 x 3/8" sheet metal screws.

NOTE: The blue and white identification label shows the Model Number and Production Series Number of your kit. Refer to these numbers in any communications with the Heath Company; this assures you that you will receive the most complete and up-to-date information in return.

- ( ) Install the identification label in the following manner:
  1. Select a location for the label where it can easily be seen when needed, but will not show when the unit is in operation. This location might be on the rear panel or the top of the chassis, or on the rear or bottom of the cabinet.
  2. Carefully peel away the backing paper. Then press the label into position.

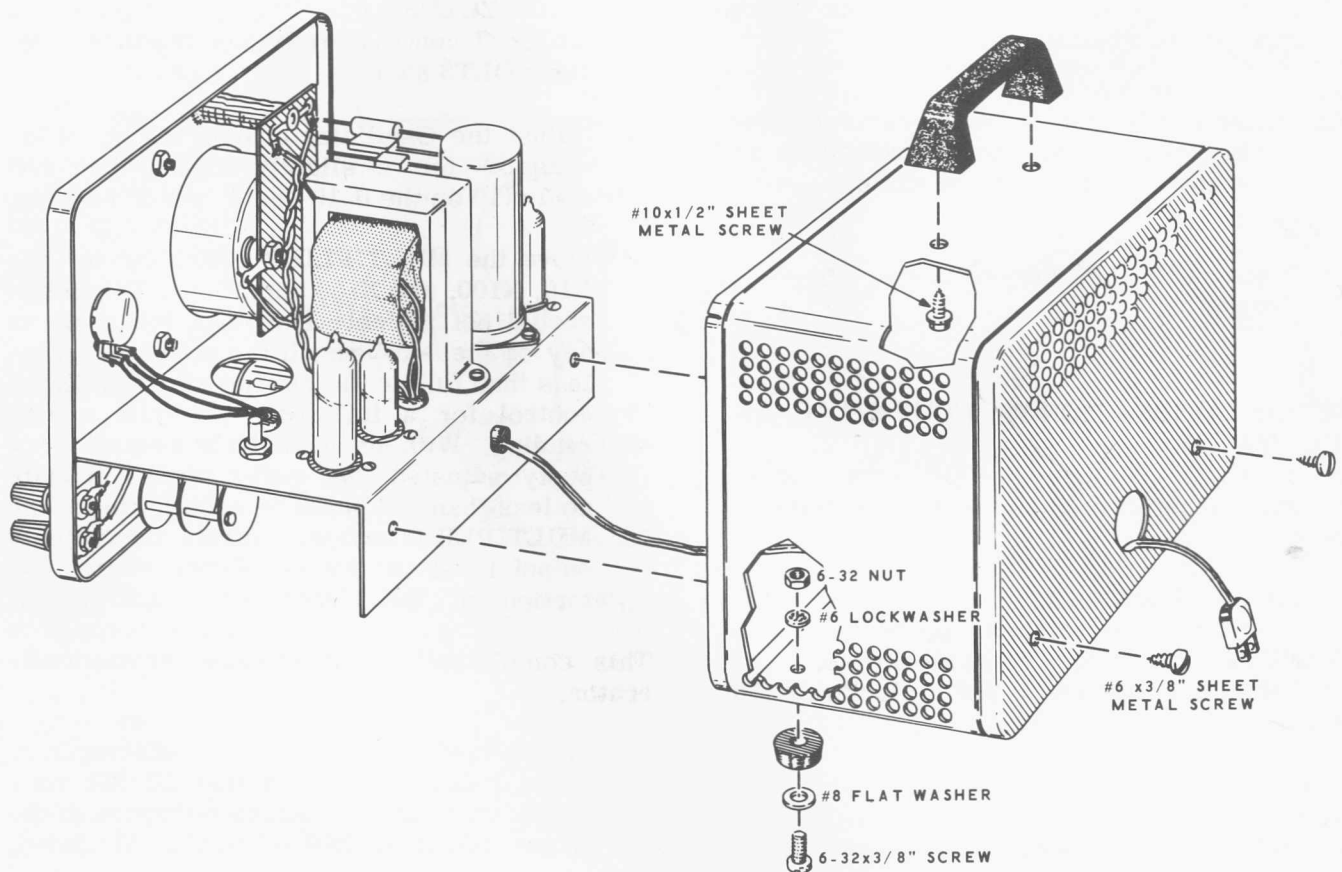

PICTORIAL 7

## OPERATION

### OUTPUT TERMINATION

The output of the Audio Generator must be properly terminated to obtain accurate meter indications.

To obtain correct meter readings with a high impedance load (10 K $\Omega$  or more); set the 600  $\Omega$  LOAD switch to INTERNAL, and set the DB/VOLTS switch to the nearest full scale value above the desired output level. Then adjust the OUTPUT control to give the desired output on the proper meter scale. **EXAMPLE:** For an output voltage of 7.3 volts, set the DB/VOLTS switch to 10 volts. Then turn the OUTPUT control to give a 7.3 reading on the 0-10 scale of the meter. **EXAMPLE:** For an output of .025 volts, set the DB/VOLTS switch to .03 volts. Then turn the OUTPUT control to give a 2.5 reading on the 0-3 meter scale.

To obtain correct meter readings with an external 600  $\Omega$  load (1 volt maximum output signal level): set the LOAD switch to EXTERNAL and proceed as before.

### FREQUENCY SELECTION

To select the desired frequency, set the Generator controls as follows:

1. 0-100 CYCLES switch to the first significant figure.
2. 0-10 CYCLES switch to the second significant figure.
3. Turn the MULTIPLIER switch to the desired position.

**EXAMPLE:** For a frequency of 35 cps, set the 0-100 CYCLES switch to 30, the 0-10 CYCLES switch to 5 and the MULTIPLIER switch to X1.

**EXAMPLE:** For a frequency of 72 kc, set the 0-100 CYCLES switch to 70, the 0-10 CYCLES switch to 2 and the MULTIPLIER switch to X1000.

### DB/VOLTS SWITCH AND OUTPUT CONTROL

To select the desired output amplitude into a high impedance load (10 K $\Omega$  or higher) set the Generator controls as follows:

1. LOAD switch to INTERNAL.
2. DB/VOLTS switch to the nearest full scale value above the desired output.
3. OUTPUT control to give the desired output reading on the appropriate meter scale.

**EXAMPLE:** Desired voltage is 5.5 volts. Set the DB/VOLTS switch to 10. Then adjust the OUTPUT control for a 5.5 reading on the 0-10 volt-meter scale.

To select the desired output amplitude into an external 600  $\Omega$  load (.003 to 1 volt positions), set the LOAD switch to EXTERNAL and proceed as before.

### USING THE DB SCALE

The decibel is a unit of relative power. It may be applied to voltage levels if the impedances are identical. It may be used as a quantitative indication for one power or voltage level if the other level is defined. In this instrument, the db scale is based on a reference or standard level of 0 db= 1 milliwatt in 600  $\Omega$ . If used with a 600  $\Omega$  external load, the meter reading is expressed in dbm and the reference level is automatically defined.

If the instrument is used with loads differing from 600  $\Omega$  but substantially less than 10 K $\Omega$ , correction factors for the voltage reduction in the attenuator and for the db level may be calculated.

If the instrument is used with high impedance loads, the relation between two signal levels may be expressed as a number of db difference.

For example, if a device requires a signal of .61 volt on one input jack for a certain output, and a signal of .012 volt on another input jack for the same output, how many db difference between the two input jacks?

.61 volt is -2 db (on meter)  $\pm 0$  db (on output switch) = -2.

.012 volt is -6 db (on meter) -30 db (on output switch) = -36.

Level difference is  $(-2) - (-36) = 34$  db.

NOTE: Theoretically the input impedances should be equal in the above example. The method described is generally more useful than calculating the power level at each input using voltage and input impedance and using the formula:

$$\text{db} = 10 \log \frac{P_1}{P_2} = 10 \log \frac{E_1^2/R_1}{E_2^2/R_2}$$

for equal impedances this reduces to:

$$\text{db} = 10 \log \left( \frac{E_1}{E_2} \right)^2 = 20 \log \frac{E_1}{E_2}$$

Although theoretically correct, an erroneous impression may be gained by using the above approach; for instance changing a 10 K $\Omega$  grid resistor to 10 megohms decreases the power level by a factor of 100, or 30 db, yet the input voltage may remain unchanged.

## IN CASE OF DIFFICULTY

1. Recheck the wiring. Trace each lead in colored pencil on the Pictorial as it is checked. It is frequently helpful to have a friend check your work. Someone who is not familiar with the unit may notice something consistently overlooked by the constructor.
2. It is interesting to note that about 90% of the kits that are returned for repair, do not function properly due to poor connections and soldering. Therefore, many troubles can be eliminated by reheating all connections to make sure that they are soldered as described in the Proper Soldering Techniques section of this manual.
3. Check to be sure that all tubes are in their proper locations. Make sure that all tubes light up properly.
4. Check the tubes with a tube tester or by substitution.
5. Check the values of the parts. Be sure that the proper part has been wired into the circuit, as shown in the pictorial diagrams and as called out in the wiring instructions.
6. Check for bits of solder, wire ends or other foreign matter which may be lodged in the wiring.
7. If, after careful checks, the trouble is still not located and a voltmeter is available, check voltage readings against those shown on the Schematic Diagram. NOTE: All voltage readings were taken with an 11 megohm input vacuum tube voltmeter. Voltages may vary as much as 10%.
8. A review of the Circuit Description will prove helpful in indicating where to look for trouble.

NOTE: If the candelabra lamp continuously flashes on and off, check all solder connections, especially on the switches.



## SERVICE INFORMATION

### SERVICE

If, after applying the information in this manual and your best efforts, you are still unable to obtain proper performance, it is suggested that you take advantage of the technical facilities which the Heath Company makes available to its customers.

The Technical Consultation Department is maintained for your benefit. This service is available to you at no charge. Its primary purpose is to provide assistance for those who encounter difficulty in the construction, operation or maintenance of HEATHKIT equipment. It is not intended, and is not equipped to function as a general source of technical information involving kit modifications nor anything other than the normal and specified performance of HEATHKIT equipment.

Although the Technical Consultants are familiar with all details of this kit, the effectiveness of their advice will depend entirely upon the amount and the accuracy of the information furnished by you. In a sense, YOU MUST QUALIFY for GOOD technical advice by helping the consultants to help you. Please use this outline:

1. Before writing, fully investigate each of the hints and suggestions listed in this manual under In Case Of Difficulty. Possibly it will not be necessary to write.
2. When writing, clearly describe the nature of the trouble and mention all associated equipment. Specifically report operating procedures, switch positions, connections to other units, and anything else that might help to isolate the cause of trouble.
3. Report fully on the results obtained when testing the unit initially and when following the suggestions under In Case Of Difficulty. Be as specific as possible and include voltage readings if test equipment is available.

4. Identify the kit Model Number and Series Number, and date of purchase, if available. Also mention the date of the kit assembly manual. (Date at bottom of Page 1.)
5. Print or type your name and address, preferably in two places on the letter.

With the preceding information, the consultant will know exactly what kit you have, what you would like it to do for you and the difficulty you wish to correct. The date of purchase tells him whether or not engineering changes have been made since it was shipped to you. He will know what you have done in an effort to locate the cause of trouble and, thereby, avoid repetitious suggestions. In short, he will devote full time to the problem at hand, and through his familiarity with the kit, plus your accurate report, he will be able to give you a complete and helpful answer. If replacement parts are required, they will be shipped to you, subject to the terms of the Warranty.

The Factory Service facilities are also available to you, in case you are not familiar enough with electronics to provide our consultants with sufficient information on which to base a diagnosis of your difficulty, or in the event that you prefer to have the difficulty corrected in this manner. You may return the completed equipment to the Heath Company for inspection and necessary repairs and adjustments. You will be charged a minimal service fee, plus the price of any additional parts or material required. However, if the completed kit is returned within the Warranty period, parts charges will be governed by the terms of the Warranty. State the date of purchase, if possible.

Local Service by Authorized HEATHKIT Service Centers is also available in some areas and often will be your fastest, most efficient method of obtaining service. HEATHKIT Service Centers will honor the regular 90 day HEATHKIT Parts Warranty on all kits, whether purchased through a dealer or directly from the Heath Company; however, it will be necessary that you verify the purchase date of your kit.

Under the conditions specified in the Warranty, replacement parts are supplied without charge; however, if the Service Center assists you in locating a defective part (or parts) in your kit, or installs a replacement part for you, you may be charged for this service.

HEATHKIT equipment purchased locally and returned to Heath Company for service must be accompanied by your copy of the dated sales receipt from your authorized HEATHKIT dealer in order to be eligible for parts replacement under the terms of the Warranty.

**THIS SERVICE POLICY APPLIES ONLY TO COMPLETED EQUIPMENT CONSTRUCTED IN ACCORDANCE WITH THE INSTRUCTIONS AS STATED IN THE MANUAL.** Equipment that has been modified in design will not be accepted for repair. If there is evidence of acid core solder or paste fluxes, the equipment will be returned NOT repaired.

For information regarding modification of HEATHKIT equipment for special applications, it is suggested that you refer to any one or more of the many publications that are available on all phases of electronics. They can be obtained at or through your local library, as well as at most electronic equipment stores. Although the Heath Company sincerely welcomes all comments and suggestions, it would be impossible to design, test, evaluate and assume responsibility for proposed circuit changes for special purposes. Therefore, such modifications must be made at the discretion of the kit builder, using information available from sources other than the Heath Company.

## REPLACEMENTS

Material supplied with HEATHKIT products has been carefully selected to meet design requirements and ordinarily will fulfill its function without difficulty. Occasionally, improper operation can be traced to a faulty component. Should inspection reveal the necessity for replacement, write to the Heath Company and supply all of the following information.

- A. Thoroughly identify the part in question by using the part number and description found in the manual Parts List.

- B. Identify the kit Model Number and Series Number.

- C. Mention date of purchase.

- D. Describe the nature of defect or reason for requesting replacement.

The Heath Company will promptly supply the necessary replacement. PLEASE DO NOT RETURN THE ORIGINAL COMPONENT UNTIL SPECIFICALLY REQUESTED TO DO SO. Do not dismantle the component in question as this will void the guarantee. This replacement policy does not cover the free replacement of parts that may have been broken or damaged through carelessness on the part of the kit builder.

## SHIPPING INSTRUCTIONS

In the event that your instrument must be returned for service, these instructions should be carefully followed.

Wrap the equipment in heavy paper, exercising care to prevent damage. Place the wrapped equipment in a stout carton of such size that at least three inches of shredded paper, excelsior, or other resilient packing material can be placed between all sides of the wrapped equipment and the carton. Close and seal the carton with gummed paper tape, or alternately, tie securely with stout cord. Clearly print the address on the carton as follows:

To: HEATH COMPANY  
Benton Harbor, Michigan 49023

ATTACH A LETTER TO THE OUTSIDE OF THE CARTON BEARING YOUR NAME, COMPLETE ADDRESS, DATE OF PURCHASE, AND A BRIEF DESCRIPTION OF THE DIFFICULTY ENCOUNTERED. Also, include your name and return address on the outside of the carton. Preferably affix one or more "Fragile" or "Handle With Care" labels to the carton, or otherwise so mark with a crayon of bright color. Ship by insured parcel post or prepaid express; note that a carrier cannot be held responsible for damage in transit if, in HIS OPINION, the article is inadequately packed for shipment.

## SPECIFICATIONS

Frequency Range. . . . .	10 cps to 100 kc.
Frequency Selection. . . . .	Switch selected, two significant figures and a multiplier.
Output Voltage Ranges. . . . .	Eight ranges, .003 to 10 volts (full scale) with 10 K $\Omega$ or higher external load.  Six ranges, .003 to 1 volt (full scale) with 600 $\Omega$ external load.
Output Impedance. . . . .	10 volt range, varies between 0 and 1000 $\Omega$ . 3 volt range, varies between 800 and 1000 $\Omega$ . 1 volt range and lower, 600 $\Omega$ External load and 290 $\Omega$ Internal load.
db Ranges. . . . .	-62 db to +22 db; -12 db to +2 db on the meter and -50 db to +20 db on the Output switch in 10 db steps.
dbm Ranges (600 $\Omega$ External Load). . . . .	-62 dbm to +2 dbm; 0 dbm = 1 mw in 600 $\Omega$ .
Output Indication. . . . .	Voltage and db scales on meter.
Output Meter Accuracy. . . . .	$\pm 5\%$ of full scale with proper load termination.
Frequency Accuracy. . . . .	Within 5%.
Distortion. . . . .	Less than 0.1% from 20 to 20,000 cps.
Tube Complement. . . . .	6X4 rectifier. 6AU6 voltage amplifier. 6CL6 cathode follower.
Power Requirements. . . . .	105-125 volts, 50/60 cps, 40 watts.
Dimensions. . . . .	9-1/2" wide x 6-1/2" high x 5" deep.
Net Weight. . . . .	6 lbs.

All prices are subject to change without notice. The Heath Company reserves the right to discontinue instruments and to change specifications at

any time without incurring any obligation to incorporate new features in instruments previously sold.

## CIRCUIT DESCRIPTION

The circuitry of the Audio Generator can be divided into four sections: Power Supply, Oscillator, Output Circuit (attenuator), and Meter Circuit. Referring to the Schematic Diagram while reading the Circuit Description may make the operation of the instrument more easily understood.

### POWER SUPPLY

The power supply uses one secondary winding of the power transformer with tube V3 as a full-wave rectifier. The output voltage from rectifier tube V3 is well filtered by capacitors C6A and C6B and the filter choke. This DC voltage is used as a plate supply voltage for tubes V1 and V2.

The other secondary winding of the power transformer supplies the required filament voltage for all three tubes and the pilot lamp.

### OSCILLATOR

The oscillator circuit consists of two tube stages. Tube V1 is connected as a pentode and functions as a broad-band voltage amplifier. Tube V2 is connected as a triode and serves as a cathode follower. Oscillation occurs in this circuit by using positive (regenerative) feedback, from the cathode of tube V2 through the tungsten filament of the 155 V 3-watt lamp, to the cathode of tube V1.

A large negative (degenerative) feedback voltage is coupled from the cathode of tube V2 through what is called a "notch" filter circuit to the grid of tube V1. This negative feedback keeps tube V1 from oscillating at all but the notch frequency. At this one frequency, the negative feedback is at a minimum and phase shift is zero. See Figure 2.

Any tendency on the part of the oscillator circuit to produce signals of varying amplitude is effectively controlled as follows: As the output signal of tube V1 increases, more current is drawn through the voltage divider consisting of the 3-watt lamp and Oscillator control R20. This increased current through the lamp increases the lamp temperature, and thus the lamp resistance increases also. The increased lamp resistance decreases the amount of positive feedback that is coupled to the cathode of tube V1. This decrease in positive feedback reduces the output signal level of tube V1.

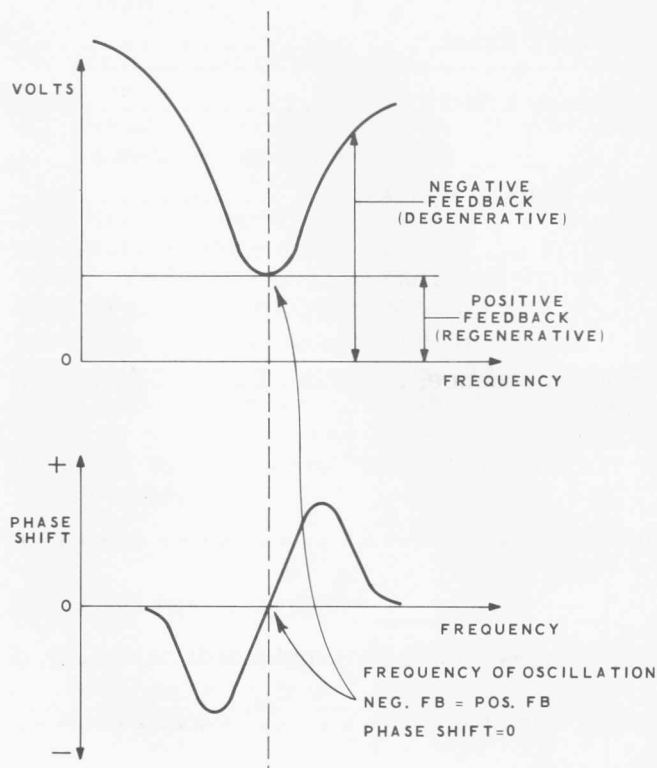

Figure 2

When the oscillator output signal decreases, the lamp cools slightly. This causes the resistance of the lamp to decrease. The lower resistance of the lamp allows more positive feedback to be applied to the cathode of tube V1, thus increasing the output signal of tube V1. In this way, the lamp holds the output of the oscillator constant.

The output of oscillator tube V1 is determined by the setting of Oscillator control R20, which is set for a nominal 10 volt output level.

The notch frequency (oscillator frequency) is determined by the values of resistance and capacitance in the notch filter circuit. These components consist of resistors R1 through R16 on the Cycles switches, and capacitors C1 through C5 on the Multiplier switch (shown in the complete notch filter circuit).

Figure 3 shows the notch filter in simplified form, which consists of two resistors and two capacitors. The values of R, C1, and C2 are shown in Figure 4 for any given switch setting.

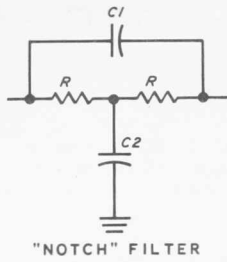

Figure 3

The following formula can be used to determine at what frequency the notch will occur for a particular set of resistors and capacitors. In this notch filter, C2 is 10 times larger than C1, and both values of R are the same.

$$\text{Frequency} = \frac{1}{2 \pi RC}$$

where  $C = \sqrt{C_1 C_2}$

and  $R = R_1 = R_2$

(R may be only one resistor or several resistors in parallel.)

VALUES OF C			VALUES OF R			
MULTIPLIER	C1	C2	CYCLES	R	CYCLES	R
X1	.05	.5	10	100 K	1	1 MEG
X10	.005	.05	20	50 K	2	510 K
X100	500	.005	30	33.3 K	3	330 K
X1000	47	500	40	25 K	4	240 K
			50	20 K	5	194 K
			60	16.7 K	6	163 K
			70	14.3 K	7	139 K
			80	12.5 K	8	122 K
			90	11.1 K	9	109 K
			100	10 K	10	100 K

Figure 4

With the Multiplier switch in the X1 position and the 0-100 Cycles switch in the 10 position, capacitors C1 and C2 with resistors R3 and R8 form the notch filter circuit. Then the oscillator frequency is 10 cps. To produce a 20 cps signal, these resistances must be halved from 100 KΩ to 50 KΩ since the frequency and resistance are inversely proportional. To increase the frequency to 100 cps (by a factor of 10), the capacitance must be decreased by a factor of 10. At the highest frequencies, the values of the capacitors are slightly below the theoretical value to allow for wiring capacitance.

Frequency variations within a 10 cps span are produced by the 0-10 Cycles switch. Here, the same circuit arrangement is used as in the 0-100

Cycles switch, however the resistance values are 10 times higher. These resistance values are connected in parallel with the resistors on the 0-100 Cycles switch to produce the 1 cps steps.

**OUTPUT CIRCUIT**

The output circuit consists of Output control R23, the DB/Volts switch, the 600 Ω Load switch, and resistors R29 through R42. When control R23 is set for maximum output, there is 10 volts of signal applied across the voltage divider network consisting of resistors R29 through R41. When the DB/Volts switch is in the +20/10 position, the full output signal is present at the Output terminals. For each decreasing position of the DB/Volts switch, the signal available at the Output terminals is decreased by 10 db.

The output of the Audio Generator is designed to be fed into an external 600 Ω load on the .003 through 1 volt positions, and into a high impedance external load on the 3 and 10 volt positions. The 600 Ω positions of the DB/Volts switch may be terminated in an internal load by placing the Load switch in the Internal position. This places resistor R42 across the output terminals. The internal load is automatically switched out of the circuit in the two HI Z positions of the DB/Volts switch. Figure 5 shows schematically the attenuation and load switching of the DB/Volts switch. The resistors in use at the various settings of the switch are easily identified.

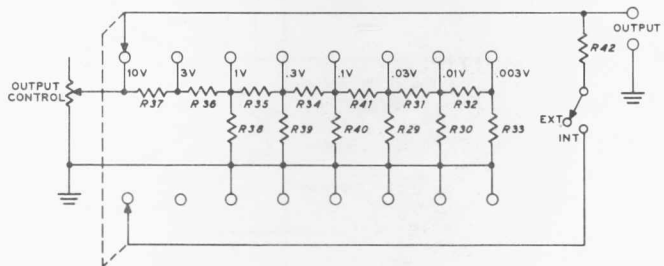
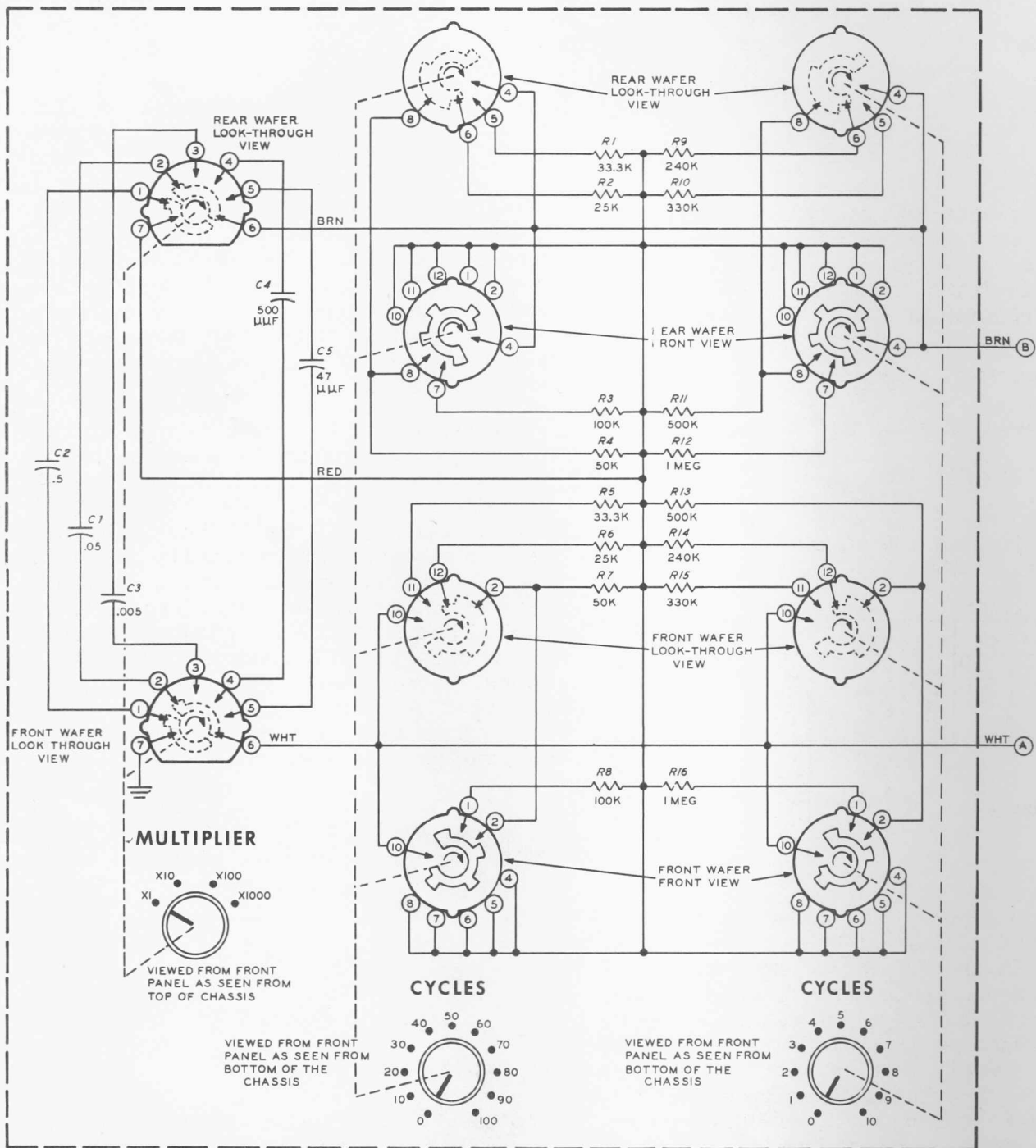

Figure 5

**METER CIRCUIT**

The meter circuit measures the voltage at the arm of Output control R23. A portion of this voltage is rectified by the bridge circuit consisting of diodes D1 and D2, and resistors R24 and R25. A third diode, D3, and resistor R26 are added to compensate for diode non-linearity at low signal levels. Meter control R28 is adjusted to give the correct meter indication for the voltage present at the Output terminals.



COMPLETE NOTCH FILTER CIRCUIT

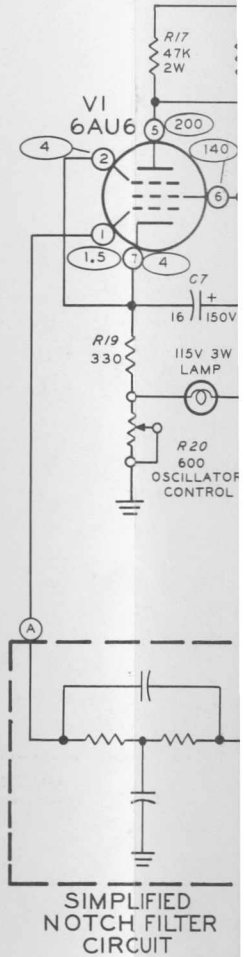

SIMPLIFIED NOTCH FILTER CIRCUIT

NOTES:

- ALL RESISTOR
- ALL RESISTOR
- ALL CAPACIT
- INDICAT
- ALL VOLTAGE
- ALL VOLTAGE
- EXCEPT A
- VOLTAGE REA
- VOLTAGES MA

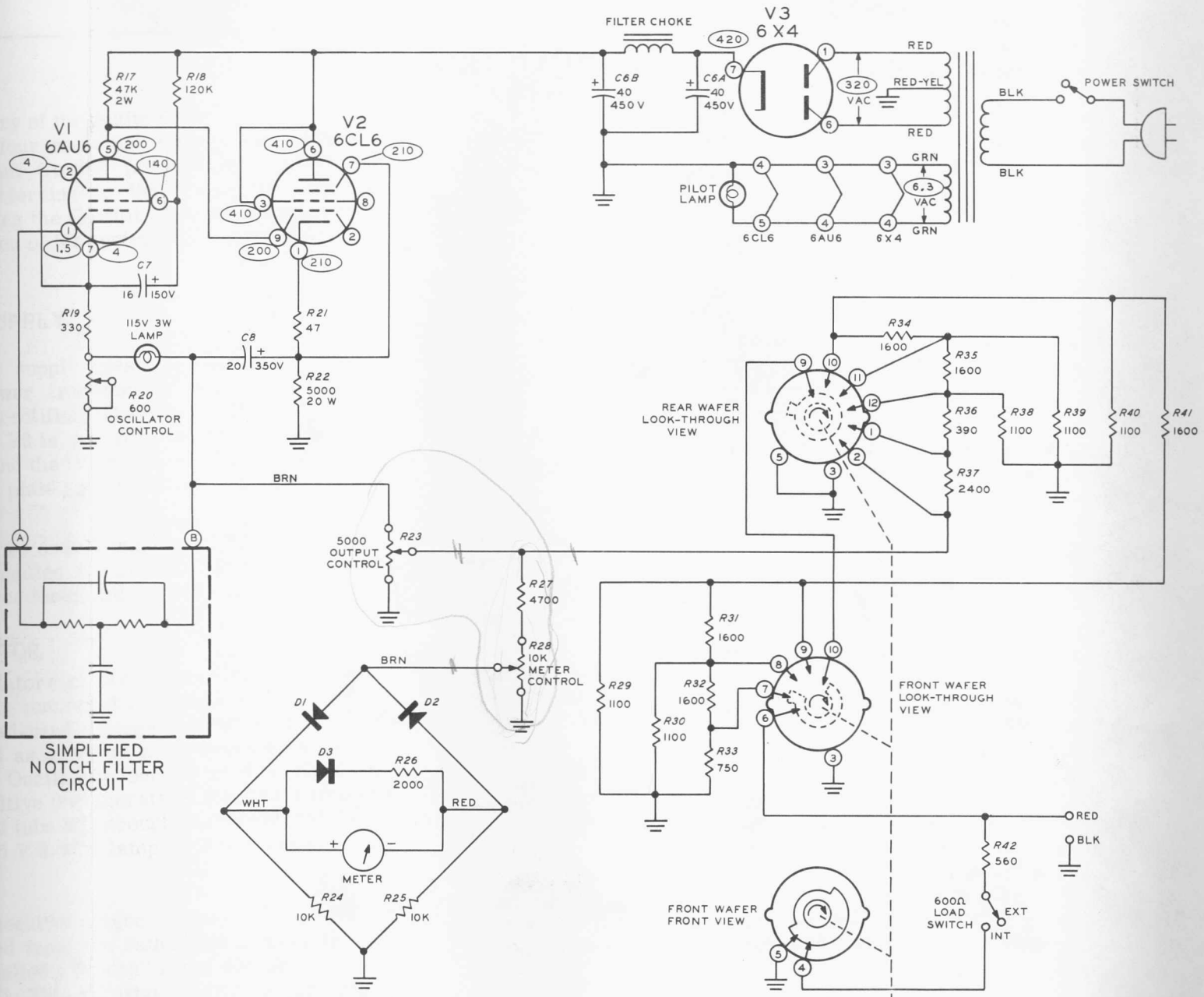

**NOTES:**

ALL RESISTORS ARE 1/2 WATT UNLESS MARKED OTHERWISE.  
 ALL RESISTOR VALUES ARE IN OHMS (K = 1000, MEG = 1,000,000).  
 ALL CAPACITOR VALUES ARE IN  $\mu$ f UNLESS MARKED OTHERWISE.  
 ○ INDICATES VOLTAGE READING.  
 ALL VOLTAGES ARE DC POSITIVE UNLESS MARKED OTHERWISE.  
 ALL VOLTAGES ARE MEASURED FROM POINT INDICATED TO CHASSIS GROUND,  
 EXCEPT AC VOLTAGES ON POWER TRANSFORMER WINDINGS.  
 VOLTAGE READINGS TAKEN WITH AN 11 MEGOHM INPUT VTVM.  
 VOLTAGES MAY VARY  $\pm 10\%$ .

**SCHEMATIC OF THE  
 HEATHKIT®  
 AUDIO GENERATOR  
 MODEL IG-72**

**DB/ VOLTS F.S.**  
 VIEWED FROM FRONT  
 PANEL AS SEEN FROM  
 BOTTOM OF THE  
 CHASSIS

## WARRANTY

Heath Company warrants that all Heathkit parts shall be free of all defects in materials and workmanship under normal use and service, and in fulfillment of such warranty Heath Company will, for a period of three months from the date of shipment, replace any part upon verification that it is defective.

The foregoing warranty shall apply only to the original buyer, and is and shall be in lieu of all other warranties, whether express or implied and of all other obligations or liabilities on the part of Heath Company and in no event shall Heath Company be liable for any anticipated profits, consequential damages, loss of time or other losses incurred by the buyer in connection with the purchase, assembly or operation of Heathkits or components thereof. No replacement shall be made of parts damaged by the buyer in the course of handling or assembling Heathkit equipment.

The foregoing warranty is completely void if corrosive solder or fluxes have been used in wiring the equipment. Heath Company will not replace or repair any equipment in which corrosive solder or fluxes have been used.

This warranty applies only to Heath equipment sold and shipped within the continental United States including APO and FPO shipments. Warranty replacement for Heathkit equipment outside the United States is on an f.o.b. factory basis. Contact the Heathkit authorized distributor in your country or write: Heath Company, International Division, Benton Harbor, Michigan, U.S.A.











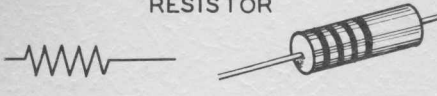
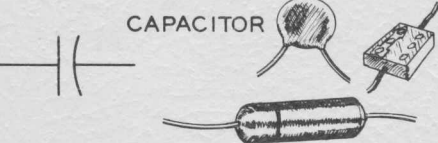
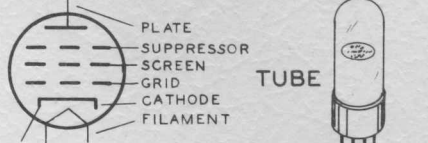



**HEATH COMPANY**

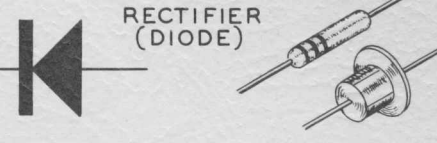
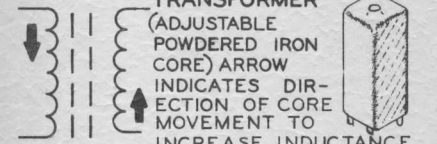
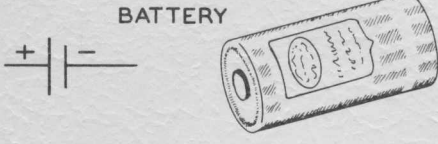
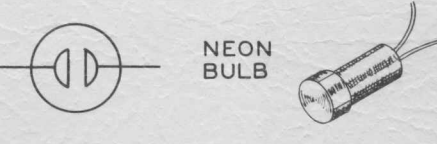
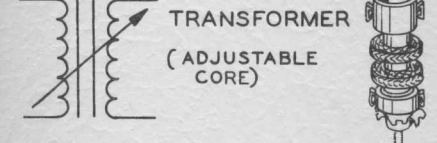
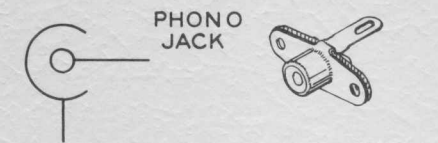
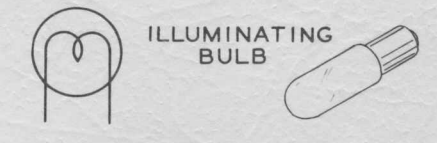
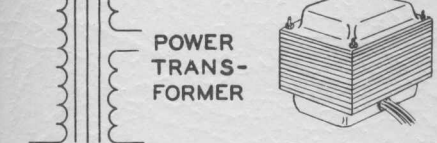
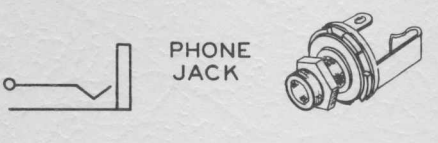
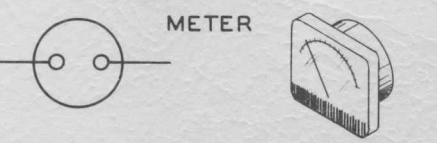
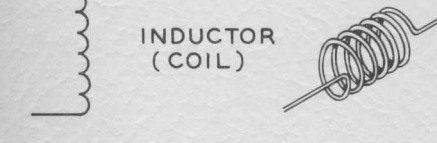
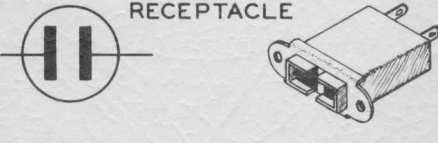
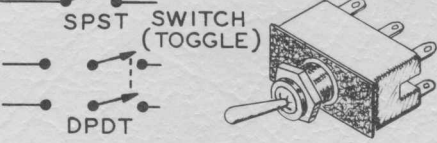
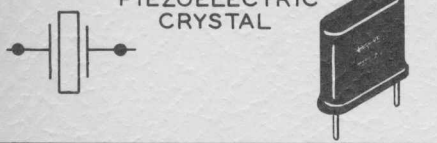

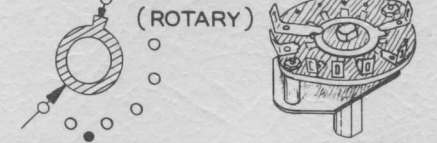
## TYPICAL COMPONENT TYPES

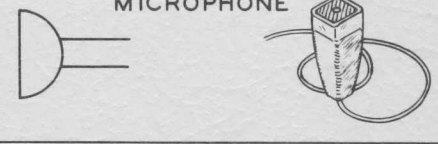
This chart is a guide to commonly used types of electronic components. The symbols and related illustrations

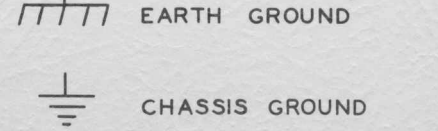
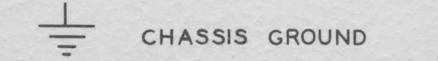
should prove helpful in identifying most parts and reading the schematic diagrams.

<p style="text-align: center;">RESISTOR</p> 	<p style="text-align: center;">CAPACITOR</p> 	<p style="text-align: center;">TUBE</p>  <p>PLATE SUPPRESSOR SCREEN GRID CATHODE FILAMENT</p>
<p style="text-align: center;">POTENTIOMETER (CONTROL)</p> 	<p style="text-align: center;">ELECTROLYTIC CAPACITOR</p> 	<p style="text-align: center;">TRANSISTOR</p>  <p>PNP BASE EMITTER COLLECTOR</p> <p>NPN BASE EMITTER</p>
<p style="text-align: center;">TRANSFORMER (IRON CORE)</p> 	<p style="text-align: center;">VARIABLE CAPACITOR</p> 	<p style="text-align: center;">RECTIFIER (DIODE)</p> 
<p style="text-align: center;">TRANSFORMER (ADJUSTABLE POWDERED IRON CORE) ARROW INDICATES DIR- ECTION OF CORE MOVEMENT TO INCREASE INDUCTANCE</p> 	<p style="text-align: center;">BATTERY</p> 	<p style="text-align: center;">NEON BULB</p> 
<p style="text-align: center;">TRANSFORMER (ADJUSTABLE CORE)</p> 	<p style="text-align: center;">PHONO JACK</p> 	<p style="text-align: center;">ILLUMINATING BULB</p> 
<p style="text-align: center;">POWER TRANSFORMER</p> 	<p style="text-align: center;">PHONE JACK</p> 	<p style="text-align: center;">METER</p> 
<p style="text-align: center;">INDUCTOR (COIL)</p> 	<p style="text-align: center;">RECEPTACLE</p> 	<p style="text-align: center;">SWITCH (TOGGLE)</p>  <p>SPST DPDT</p>
<p style="text-align: center;">PIEZOELECTRIC CRYSTAL</p> 	<p style="text-align: center;">SPEAKER</p> 	<p style="text-align: center;">SWITCH (ROTARY)</p> 
<p style="text-align: center;">BINDING POST</p> 	<p style="text-align: center;">MICROPHONE</p> 	<p style="text-align: center;">FUSE</p> 
<p style="text-align: center;">ANTENNA</p>  <p>GENERAL      LOOP</p>	<p style="text-align: center;">EARTH GROUND</p>  <p style="text-align: center;">CHASSIS GROUND</p> 	<p style="text-align: center;">CONDUCTORS</p>  <p>NOT CONNECTED      CONNECTED      SHIELDED</p>

# HEATH COMPANY

BENTON HARBOR, MICHIGAN

**THE WORLD'S FINEST ELECTRONIC EQUIPMENT IN KIT FORM**



# HEATH COMPANY

Phone 616-983-3961 • TWX-616-983-3897 • Benton Harbor, Michigan 49023

October 5, 1965

Dear Customer:

The terminal board #431-23 supplied with your IG-72 kit has three less terminal lugs than the board shown in your assembly Manual. The new type terminal board should be mounted and wired the same as the old board since the three terminal lugs that have been deleted were not used. Refer to the illustration below to determine the difference between the two terminal boards.

THESE THREE LUGS HAVE BEEN  
DELETED AS THEY WERE NOT USED.

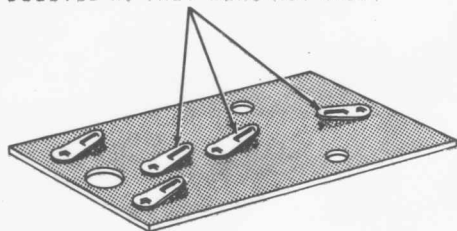

OLD TERMINAL BOARD

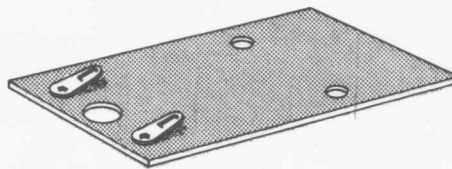

NEW TERMINAL BOARD

Thank you,

HEATH COMPANY

IG-72  
10-5-65