

HEATH COMPANY  
BENTON HARBOR, MICHIGAN

PRICE \$2.00

# HEATHKIT<sup>®</sup> ASSEMBLY MANUAL



Copyright © 1967  
Heath Company  
All rights reserved

## CAPACITOR SUBSTITUTION BOX











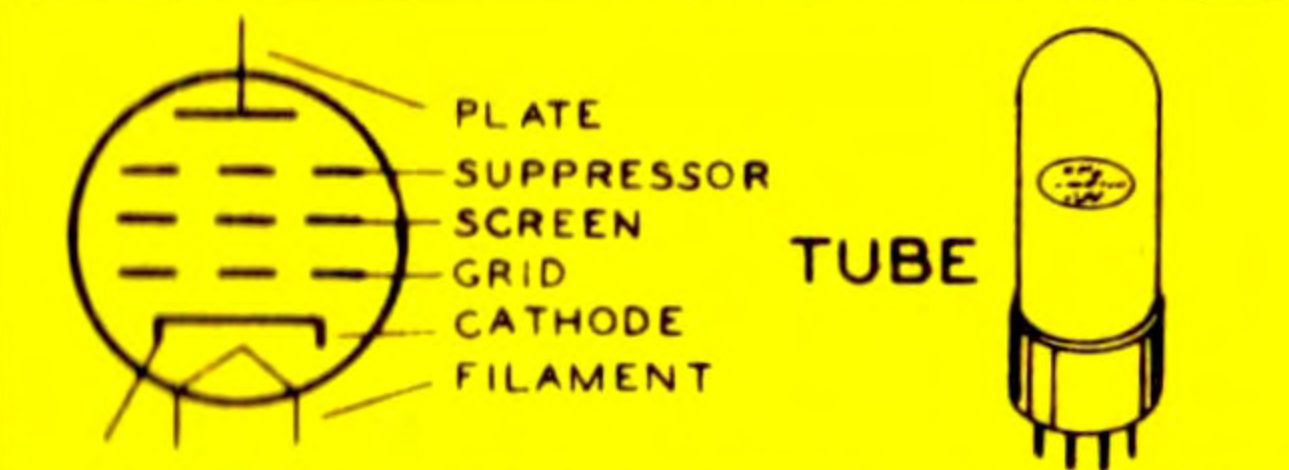
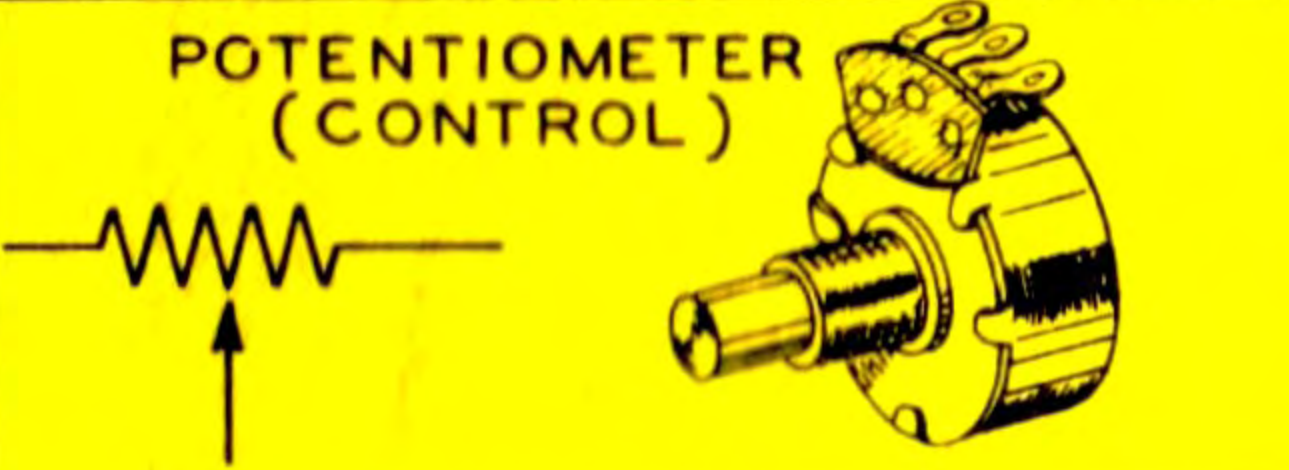

MODEL IN-47

695-873-01  
9-19-69

# TYPICAL COMPONENT TYPES

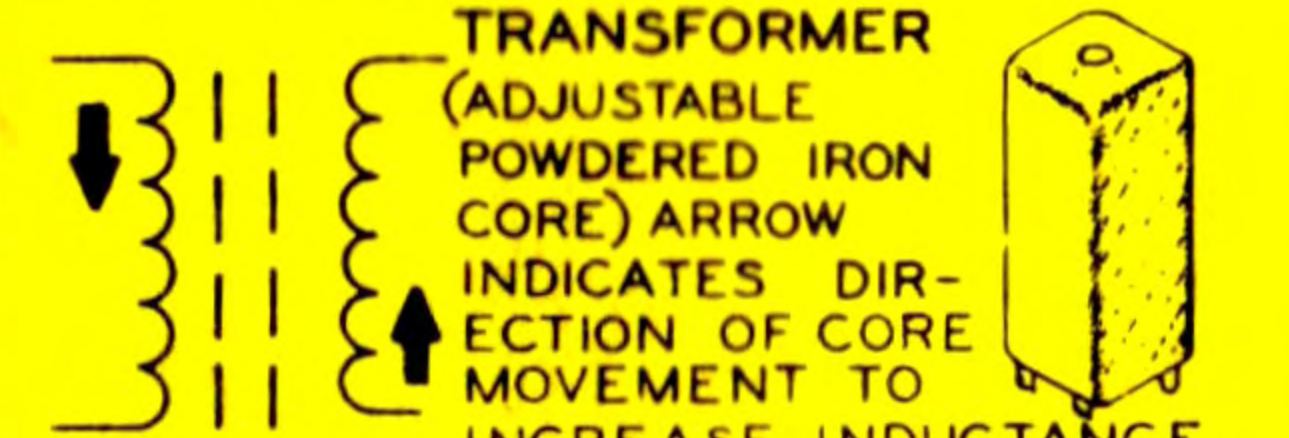
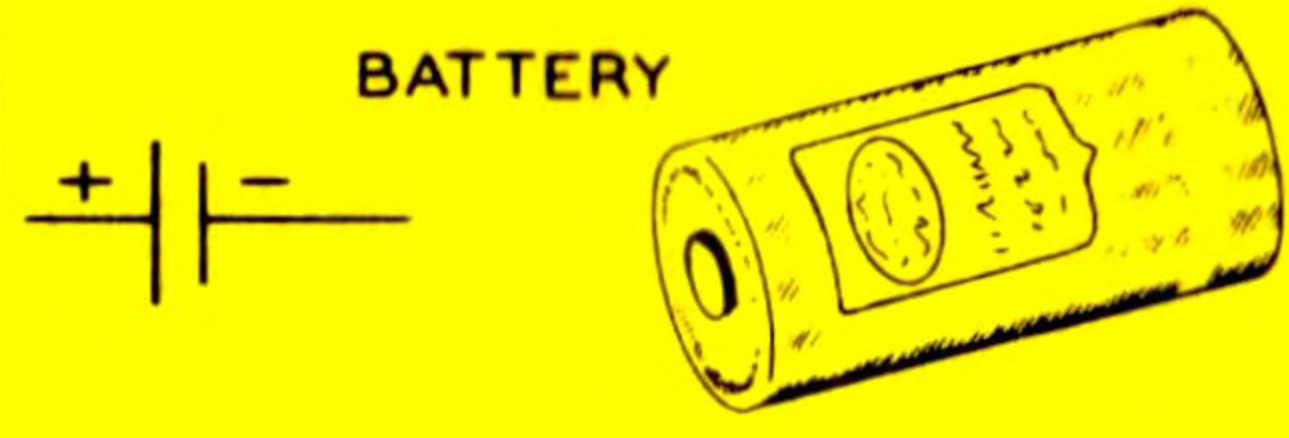
This chart is a guide to commonly used types of electronic components. The symbols and related illustrations

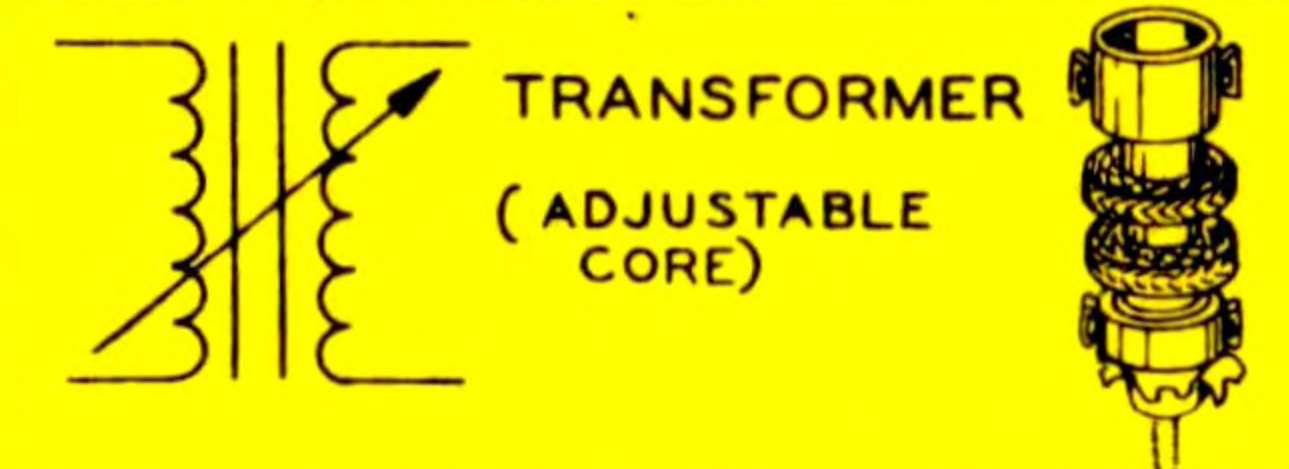
should prove helpful in identifying most parts and reading the schematic diagrams.

<p>RESISTOR</p> 	<p>CAPACITOR</p> 	<p>TUBE</p> 
<p>POTENTIOMETER (CONTROL)</p> 	<p>ELECTROLYTIC CAPACITOR</p> 	<p>TRANSISTOR</p> 
<p>TRANSFORMER (IRON CORE)</p> 	<p>VARIABLE CAPACITOR</p> 	<p>RECTIFIER (DIODE)</p> 
<p>TRANSFORMER (ADJUSTABLE POWDERED IRON CORE) ARROW INDICATES DIRECTION OF CORE MOVEMENT TO INCREASE INDUCTANCE</p> 	<p>BATTERY</p> 	<p>NEON BULB</p> 
<p>TRANSFORMER (ADJUSTABLE CORE)</p> 	<p>PHONO JACK</p> 	<p>ILLUMINATING BULB</p> 

Continued on Back Cover

# Assembly and Operation of the



# CAPACITOR SUBSTITUTION BOX

MODEL IN-47



HEATH COMPANY  
BENTON HARBOR, MICHIGAN 49022

## TABLE OF CONTENTS

Specifications. . . . .	2
Description. . . . .	2
Parts List. . . . .	3
Assembly Notes. . . . .	5
Step-By-Step Assembly. . . . .	6
In Case Of Difficulty. . . . .	13
Replacement Parts Price List. . . . .	14
Factory Repair Service. . . . .	16

## SPECIFICATIONS

Range. . . . .	0.0001 $\mu$ fd through .22 $\mu$ fd.
Voltage Rating. . . . .	0.0001 $\mu$ fd through .00047 $\mu$ fd: 500 volts. 0.001 $\mu$ fd through .1 $\mu$ fd: 600 volts. 0.15 $\mu$ fd through .22 $\mu$ fd: 400 volts.
Accuracy. . . . .	0.0001 $\mu$ fd through .00047 $\mu$ fd: $\pm 5\%$ . 0.01 through .22 $\mu$ fd: $\pm 10\%$ .
Components. . . . .	Silver mica and Mylar. *
Dimensions. . . . .	6" long x 3" wide x 3" high.
Net Weight. . . . .	1 lb. *DuPont Registered Trademark

The Heath Company reserves the right to discontinue instruments and to change specifications at any time without incurring any obligation to incorporate new features in instruments previously sold.

Refer to the "Kit Builders Guide" for complete information on unpacking, parts identification, tools, wiring, soldering, and step-by-step assembly procedures.

## DESCRIPTION

The Model IN-47 Capacitor Substitution Box has been designed to provide a fast and convenient means of determining proper capacitance values for circuit substitution or circuit experimentation, eliminating time-consuming calculation.

The special rotary switch incorporates make-before-break contacts that provide smooth changes in capacitance without "opening" or "shorting" the circuit under test.

# PARTS LIST

Unpack the kit carefully and check each part against the Parts List. The numbers in parentheses in the Parts List correspond to the numbers of the parts drawings to aid in quick and positive parts identification.

To order replacement parts, refer to the "Replacement Parts Price List" and use the Parts Order Form furnished with this kit.

PART No.	PARTS Per Kit	DESCRIPTION
----------	---------------	-------------

### CAPACITORS

(1) 20-38	1	.0001 $\mu$ fd (100 $\mu$ mf) mica (brown-black-brown)
20-39	1	.00022 $\mu$ fd (220 $\mu$ mf) mica (red-red-brown)
20-40	1	.00047 $\mu$ fd (470 $\mu$ mf) mica (yellow-violet-brown)
(2) 27-101	1	.001 $\mu$ fd Mylar
27-102	1	.0015 $\mu$ fd Mylar
27-103	1	.0022 $\mu$ fd Mylar
27-91	1	.0033 $\mu$ fd Mylar
27-104	1	.0047 $\mu$ fd Mylar
27-105	1	.0068 $\mu$ fd Mylar
27-106	1	.01 $\mu$ fd Mylar
27-107	1	.015 $\mu$ fd Mylar
27-108	1	.022 $\mu$ fd Mylar
27-109	1	.033 $\mu$ fd Mylar
27-110	1	.047 $\mu$ fd Mylar
27-111	1	.068 $\mu$ fd Mylar
27-112	1	.1 $\mu$ fd Mylar
27-113	1	.15 $\mu$ fd Mylar
27-114	1	.22 $\mu$ fd Mylar

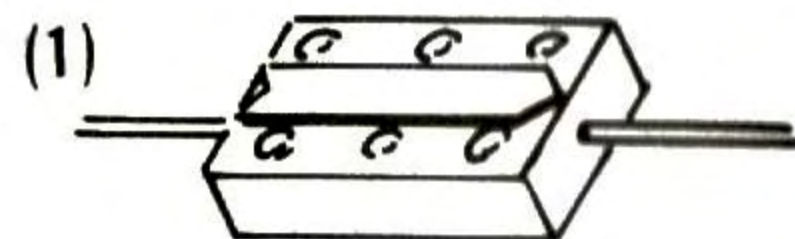

PART No.	PARTS Per Kit	DESCRIPTION
----------	---------------	-------------

### HARDWARE

(3) 250-213	4	4-40 screw
(4) 252-3	2	6-32 nut
(5) 252-7	1	Control nut
(6) 253-1	2	Fiber flat washer
(7) 253-2	2	Fiber shoulder washer
(8) 253-10	1	Control flat washer
(9) 254-4	1	Control lockwasher
(10) 259-1	2	Solder lug

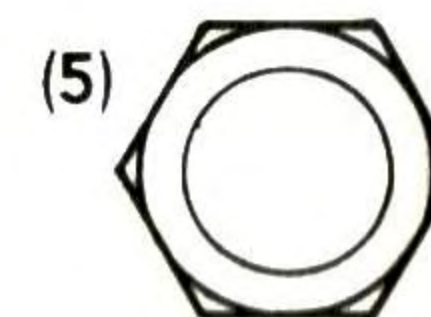

### WIRE-SLEEVING

341-1	1	Black test lead
341-2	1	Red test lead
344-59	1	Hookup wire
346-1	1	Sleeving

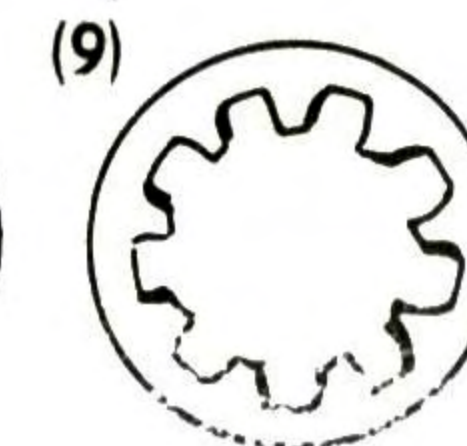
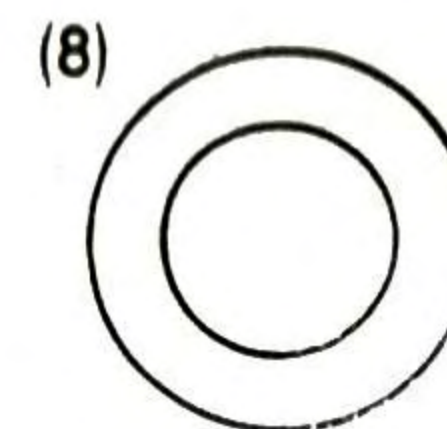
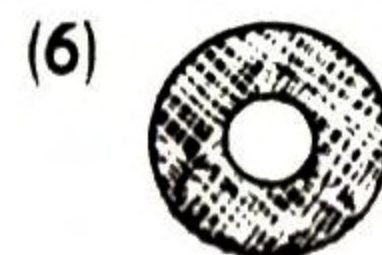

<u>PART No.</u>	<u>PARTS Per Kit</u>	<u>DESCRIPTION</u>
<b>MISCELLANEOUS</b>		
(1) 438-13	2	Banana plug
(2) 70-5	1	Black banana plug insulator
70-6	1	Red banana plug insulator
(3) 427-2	2	Binding post base
(4) 100-16-2	1	Black binding post cap
100-16-18	1	Red binding post cap
(5) 260-1	2	Alligator clip
(6) 75-12	1	Plastic insulator
63-451	1	18-position rotary switch
203-417-2	1	Front panel
408-11	1	Case
462-245	1	Knob
(7) 213-2	1	Capacitor connecting wire
(8) 455-50	1	Knob bushing
391-34	1	Blue and white identification label
597-260	1	Parts Order Form
597-308	1	Kit Builders Guide
	1	Manual (See front cover for part number).
		Solder

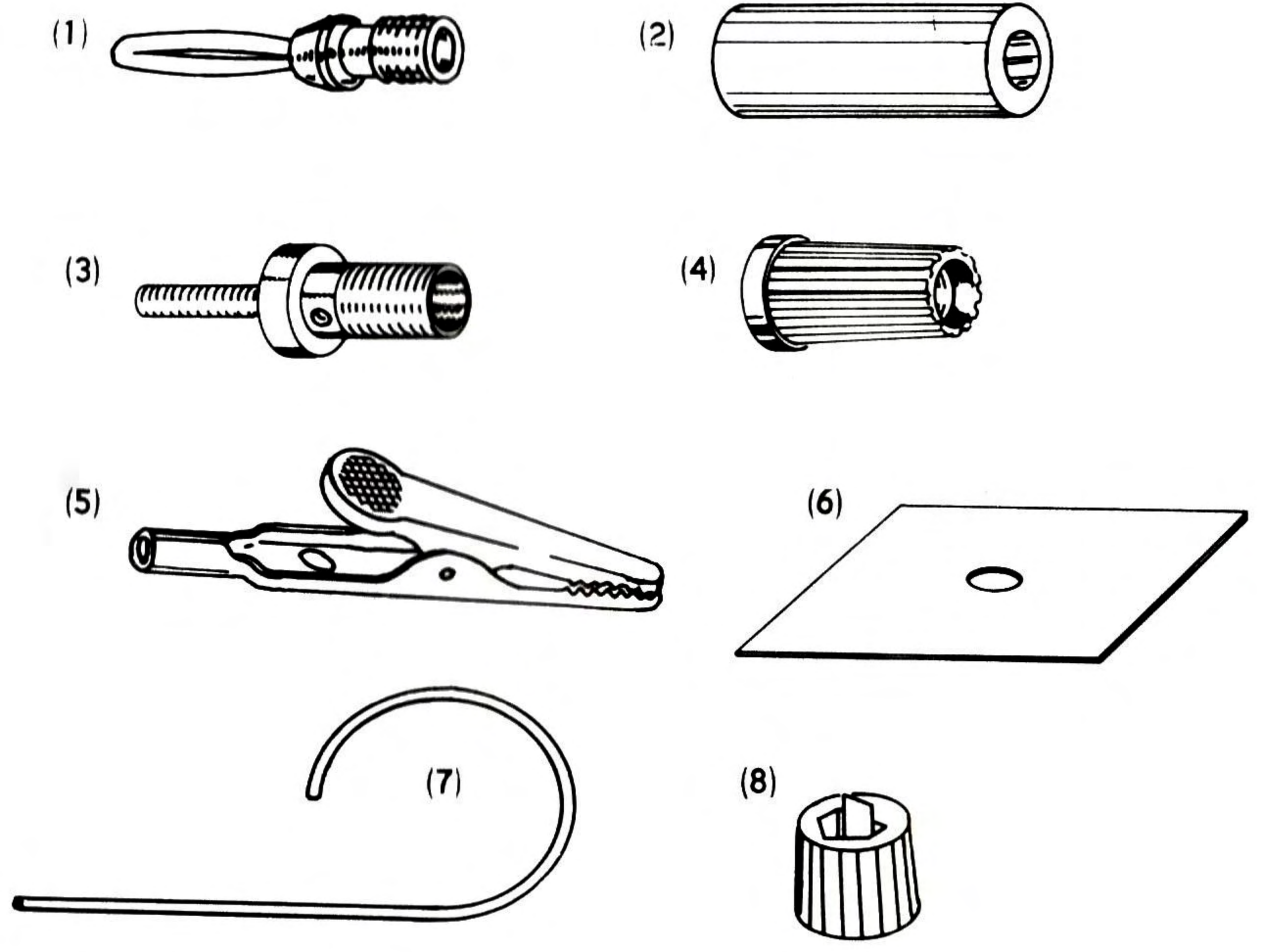

## ASSEMBLY NOTES

The following instructions are presented in a logical step-by-step sequence to enable you to complete your kit with the least possible confusion. Be sure to read each step all the way through before beginning the specified operation. Also read several steps ahead of the actual step being performed. This will familiarize you with the relationship of the subsequent operations. When the step is completed, check it off in the space provided. This is particularly important, as it may prevent errors or omissions, especially if your work is interrupted.

In general, the illustrations in this manual correspond to the actual configuration of the kit; however, in some instances the illustrations may be slightly distorted to facilitate clearly showing all of the parts.

The abbreviation "NS" indicates that a connection should not be soldered yet as other wires will be added. When the last wire is

installed, the terminal should be soldered and the abbreviation "S" is used to indicate this. Note that a number will appear after each solder instruction. This number indicates the number of leads that are supposed to be connected to the terminal in point before it is soldered. For example, if the instruction reads, "Connect a lead to lug 1 (S-2)," it will be understood that there will be two leads connected to the terminal at the time it is soldered.

Position the work, if possible, so that gravity will help to keep the solder where you want it. The joint to be soldered should be heated with the flat side of the soldering iron tip sufficiently to melt the solder. Apply only enough solder to the heated terminal to thoroughly wet the junction. Remove the solder and then the iron when a smooth soldered junction appears. Do not move the leads until the solder is solidified.

ROSIN CORE SOLDER HAS BEEN SUPPLIED WITH THIS KIT. THIS TYPE OF SOLDER MUST BE USED FOR ALL SOLDERING IN THIS KIT. ALL GUARANTEES ARE VOIDED AND WE WILL NOT REPAIR OR SERVICE EQUIPMENT IN WHICH ACID CORE SOLDER OR PASTE FLUXES HAVE BEEN USED. IF ADDITIONAL SOLDER IS NEEDED, BE SURE TO PURCHASE ROSIN CORE (60:40 or 50:50 TIN-LEAD CONTENT) RADIO TYPE SOLDER.

## STEP-BY-STEP ASSEMBLY

### MECHANICAL ASSEMBLY

Before starting to assemble this kit, read the Kit Builders Guide for complete information on tools, wiring, soldering and Step-By-Step Assembly procedures.

Refer to Pictorial 1 for the following steps.

- ( ) Install binding post bases at locations B and C. Use fiber shoulder washers, fiber flat washers, solder lugs, and 6-32 nuts. Position the solder lugs as shown.
- ( ) Install a red binding post cap on B and a black binding post cap on C.
- ( ) With a pair of pliers, rotate the shaft until the wiper lines up with lug 18, indicated by the arrow. The wiper can be seen through the openings in the edge of the switch.

- ( ) Install the plastic insulator and rotary switch at location A. Use a control lockwasher, control flat washer, and a control nut. Position lug 19 toward the binding post bases as shown.

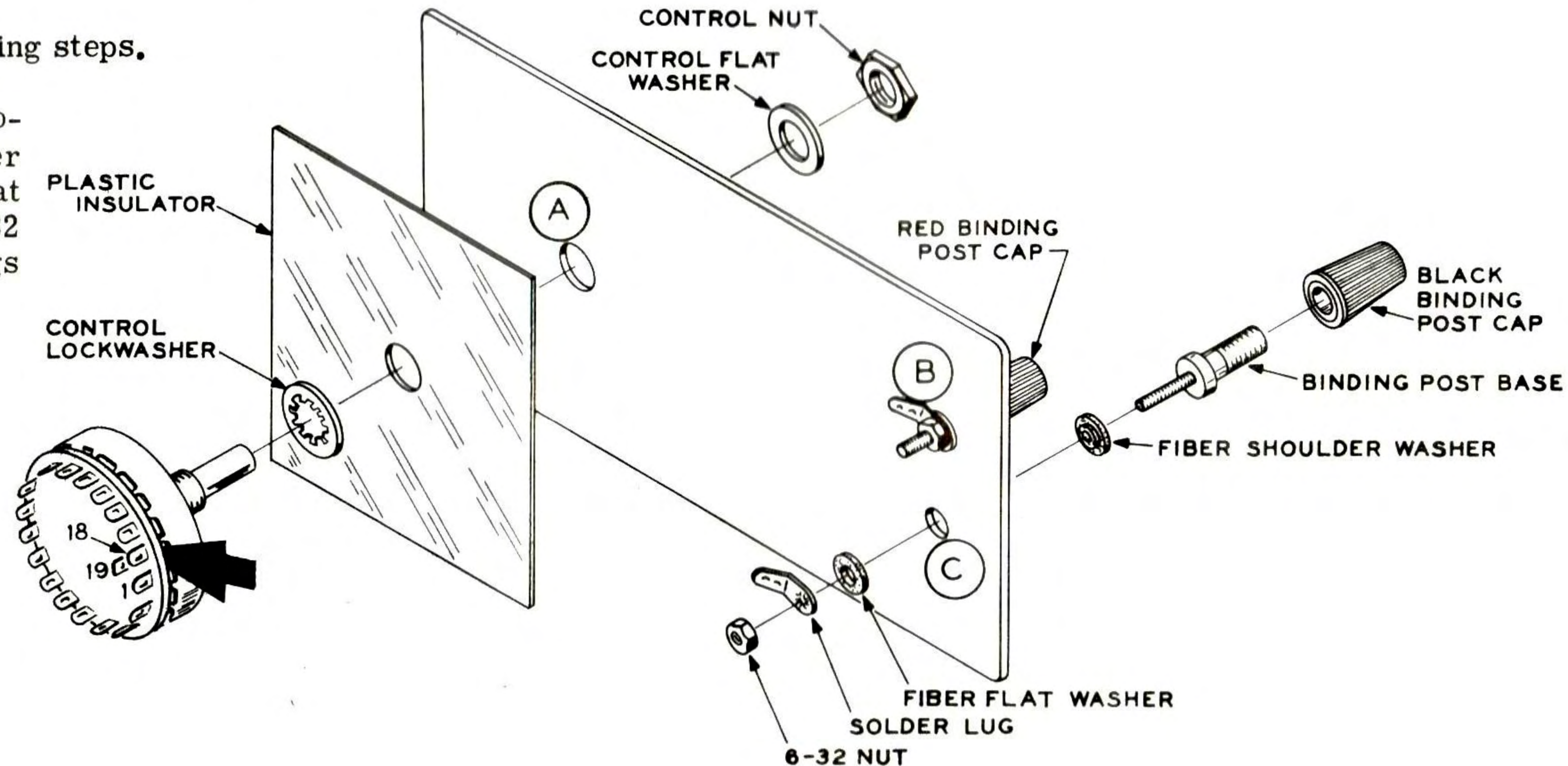

PICTORIAL 1



## KNOB INSTALLATION

The knob supplied with this kit uses a knob bushing that provides permanent positive action without the use of setscrews.

In the following steps you will install a knob on the switch shaft as shown in Detail 1A. Perform these steps carefully, as a knob bushing cannot be removed from a knob once it is fully inserted.

- ( ) Push the knob bushing part way onto the switch shaft.
- ( ) Line up the pointer of the knob with the .0001 marking on the panel. Then press the knob slightly onto the knob bushing.
- ( ) Turn the knob clockwise to each of the switch stop positions. Check to see that the pointer lines up with each panel marking.

**NOTE:** Perform the next three steps only if the pointer does not line up at each switch marking.

1. ( ) Turn the knob pointer to the mid-position marking on the panel.
2. ( ) Remove the knob from the bushing and turn it slightly to line up the pointer with the mid-position marking.
3. ( ) Press the knob slightly onto the knob bushing. Then turn the knob to each switch position and recheck the pointer alignment. If more than a slight error is noticed at either end position, repeat these three steps.

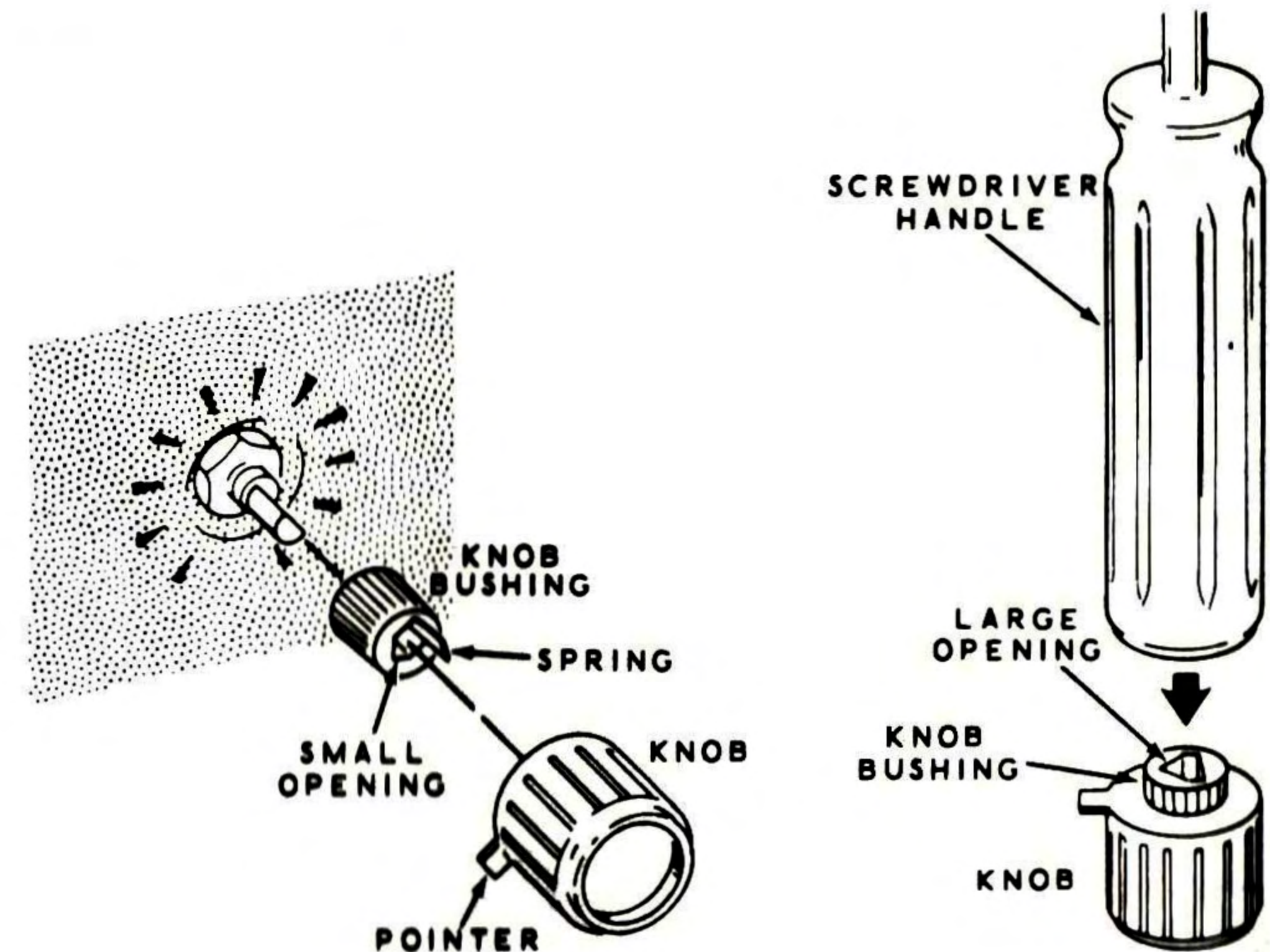

Detail 1A

- ( ) Carefully remove the knob bushing and knob together.
- ( ) Place the knob on a table or other hard surface, then press the knob bushing firmly into the knob. Use a towel or soft cloth on the work surface to avoid scratching the knob.
- ( ) Press the knob and bushing firmly onto the switch shaft.

## CAPACITOR MOUNTING

Refer to Pictorial 2 for the following steps.

**NOTE:** In the following steps a number of Mylar capacitors will be installed. The marked end (see Detail 2A) of these capacitors should be positioned as shown. Leave the capacitor leads just long enough to allow positioning each capacitor as shown in the pictorials. The following three capacitors should be pressed down against the panel.

MARKED END MUST BE PLACED  
AS SHOWN IN THE PICTORIAL

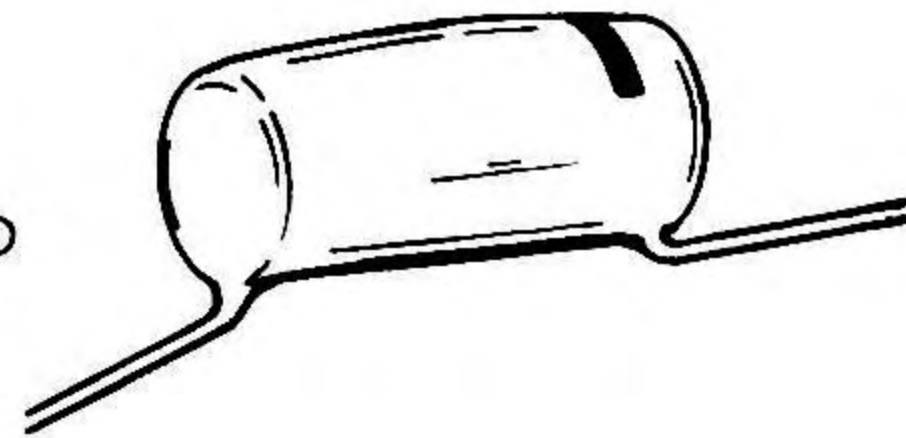

**Detail 2A**

- ( ) Connect one lead of a .033  $\mu$ fd Mylar capacitor to lug 6 of switch A (S-1). Use sleeving. Position the capacitor about 1/2" from the edge of the panel, so the case will fit properly. The other lead will be connected later.

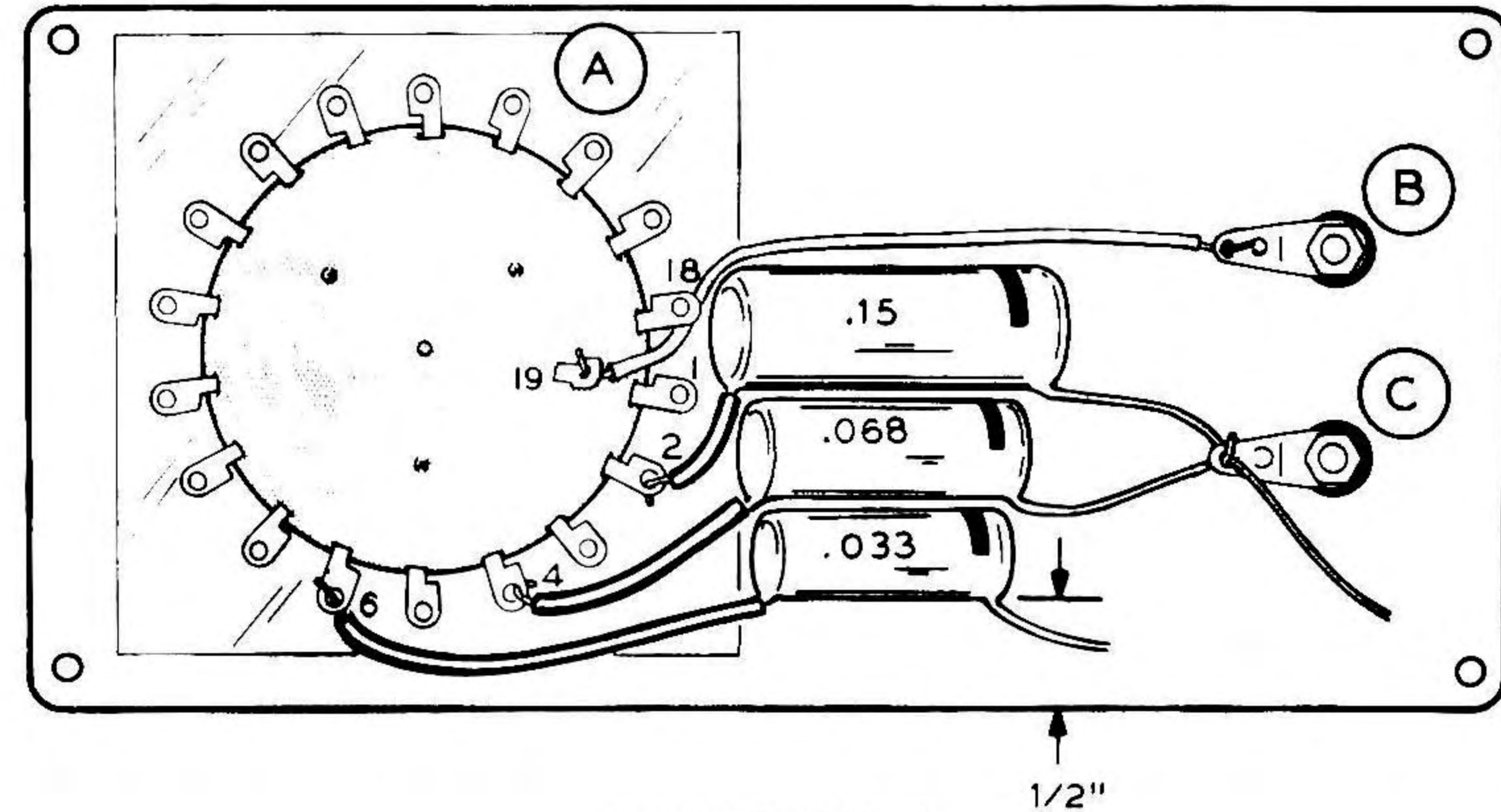

**PICTORIAL 2**

- ( ) Connect a .068  $\mu$ fd Mylar capacitor from lug 4 of switch A (S-1) to solder lug C (NS). Do not cut off the excess lead at solder lug C. Use sleeving on the lead to the switch.
- ( ) Connect a .15  $\mu$ fd Mylar capacitor from lug 2 of switch A (S-1) to solder lug C (S-3). Use sleeving on the lead to the switch.
- ( ) Strip 1/4" of insulation from the ends of a 3-1/2" hookup wire. Connect this wire from lug 19 of switch A (S-1) to solder lug B (S-1). Position the wire between lugs 1 and 18 of the switch.

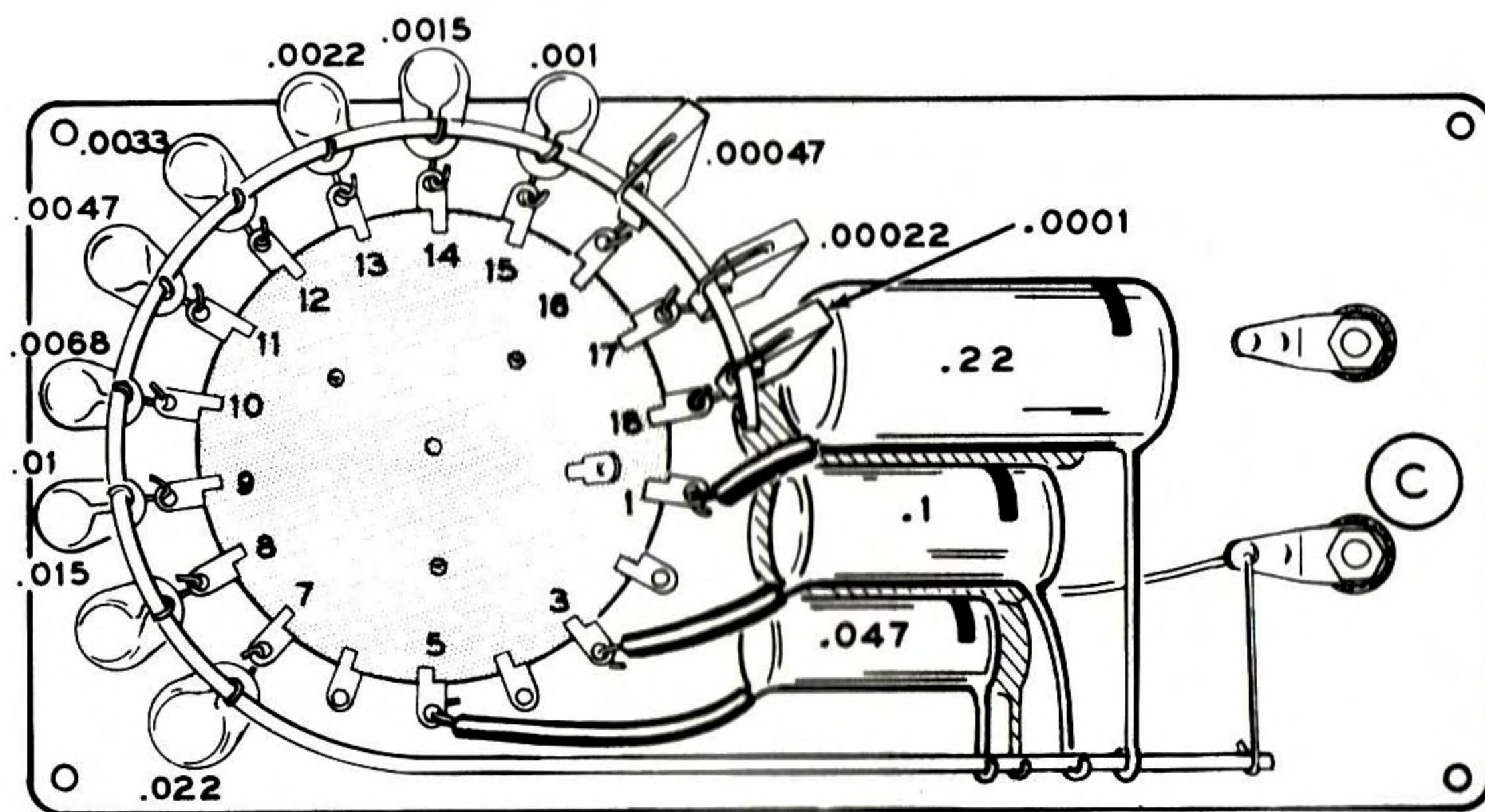

PICTORIAL 3

Refer to Pictorial 3 for the following steps.

- ( ) Connect one lead of a  $.22 \mu\text{fd}$  Mylar capacitor to lug 1 of switch A (S-1). Use sleeving. Position the capacitor directly on top of the  $.15 \mu\text{fd}$  capacitor. The other lead will be connected later.
- ( ) Connect one lead of a  $.1 \mu\text{fd}$  Mylar capacitor to lug 3 of switch A (S-1). Use sleeving. Position this capacitor directly on top of the  $.068 \mu\text{fd}$  capacitor. The other lead will be connected later.
- ( ) Connect one lead of a  $.047 \mu\text{fd}$  Mylar capacitor to lug 5 of switch A (S-1). Use sleeving. Position this capacitor directly on top of the  $.033 \mu\text{fd}$  capacitor. The other lead will be connected later.

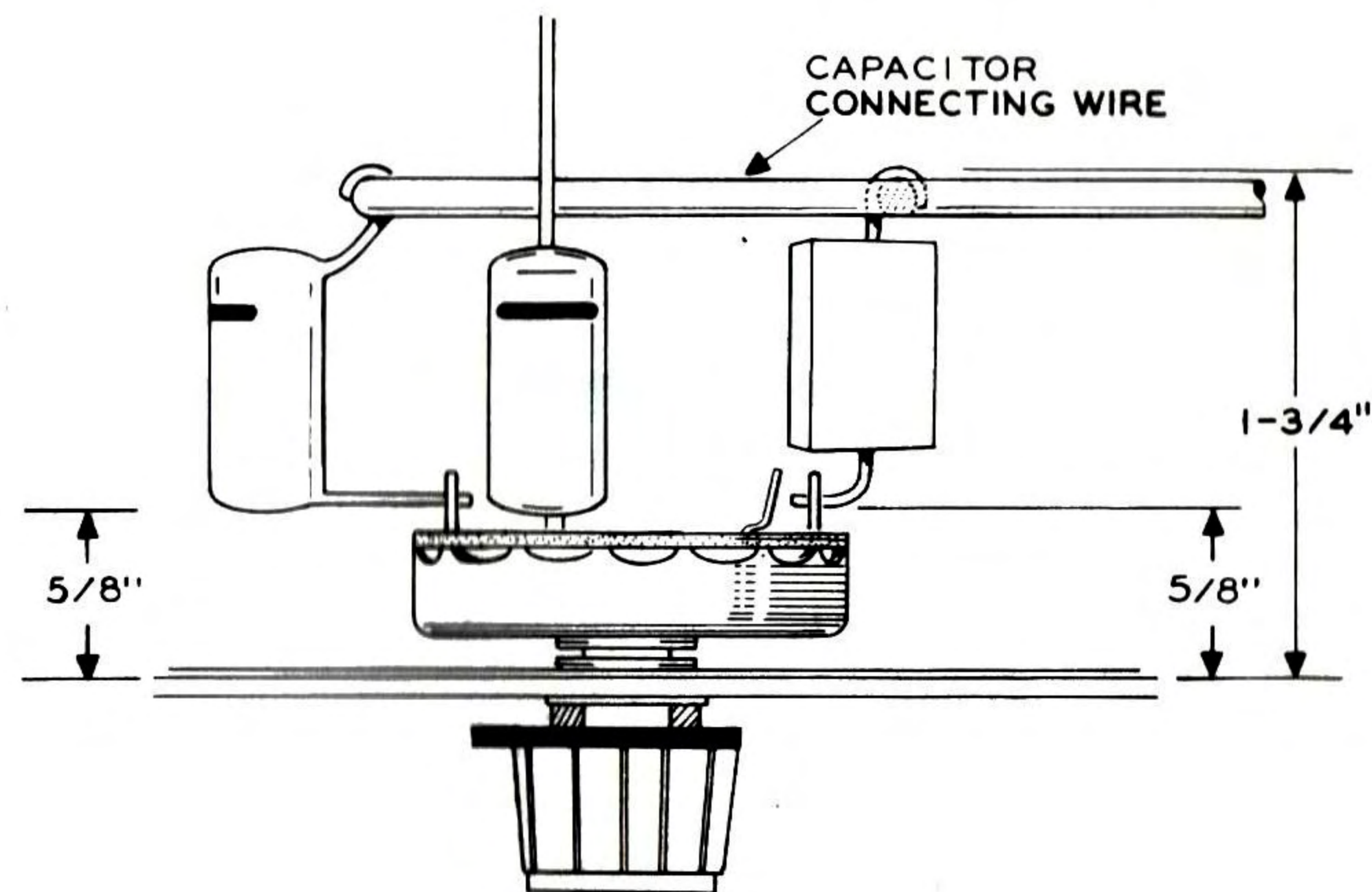

Detail 3A

Refer to Detail 3A, connect the lead from the unmarked end of each of the following capacitors to switch A. Position the capacitors as shown, and keep them at least  $1/2$ " from the edge of the panel, so the case will fit properly. **Do not** install the capacitor connecting wire until instructed to do so.

- ( )  $.022 \mu\text{fd}$  Mylar to lug 7 (S-1).
- ( )  $.015 \mu\text{fd}$  Mylar to lug 8 (S-1).
- ( )  $.01 \mu\text{fd}$  Mylar to lug 9 (S-1).
- ( )  $.0068 \mu\text{fd}$  Mylar to lug 10 (S-1).
- ( )  $.0047 \mu\text{fd}$  Mylar to lug 11 (S-1).

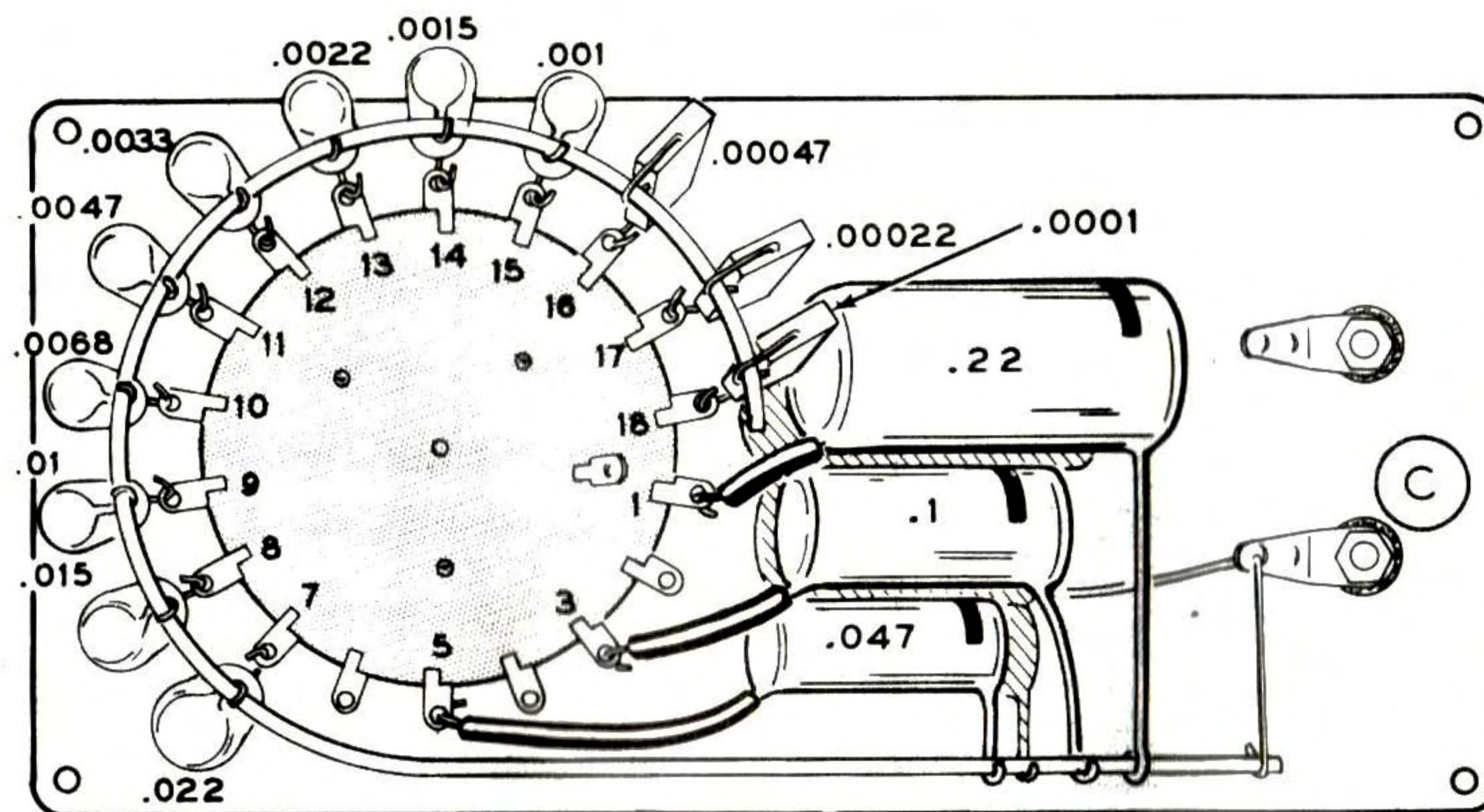

PICTORIAL 3  
(Repeat)

( ) .0033  $\mu$ fd Mylar to lug 12 (S-1).

( ) .0022  $\mu$ fd Mylar to lug 13 (S-1).

( ) .0015  $\mu$ fd Mylar to lug 14 (S-1).

( ) .001  $\mu$ fd Mylar to lug 15 (S-1).

NOTE: The value of the mica capacitors to be installed in the following steps can be indicated in two ways; either by color coding, or stamped with the  $\mu\mu$ f or  $\mu$ fd value. If color coding is used, refer to the inside cover of the manual for information on reading the color code.

( ) .00047  $\mu$ fd (470  $\mu\mu$ f) mica (yellow-violet-brown) to lug 16 (S-1).

( ) .00022  $\mu$ fd (220  $\mu\mu$ f) mica (red-red-brown) to lug 17 (S-1).

( ) .0001  $\mu$ fd (100  $\mu\mu$ f) mica (brown-black-brown) to lug 18 (S-1).

( ) Locate the capacitor connecting wire; position it as shown in Pictorial 3 and Detail 3A.

- ( ) Bend the free leads of the capacitors connected to switch lugs 7, 12, and 18 around the capacitor connecting wire, to hold the connecting wire 1-3/4" above the panel, and in the position shown. Carefully position the wire and then solder the three connections.
- ( ) Connect the free wire extending from solder lug C to the end of the capacitor connecting wire (S-1).
- ( ) Connect the free wires of the .22  $\mu$ fd, .1  $\mu$ fd, .033  $\mu$ fd, and .047  $\mu$ fd capacitors to the capacitor connecting wire and solder each connection.
- ( ) Now connect the free lead of each remaining capacitor to the capacitor connecting wire. Solder each connection.
- ( ) Referring to Detail 3B, prepare a black and a red test lead as shown. Use the black banana plug insulator on the black lead, and the red banana plug insulator on the red lead. First, strip the ends of each test lead. Then slip the banana plug insulator over one end and attach the end to the banana plug. Screw the sleeve onto the banana plug. Solder an alligator clip to the other end of each test lead.

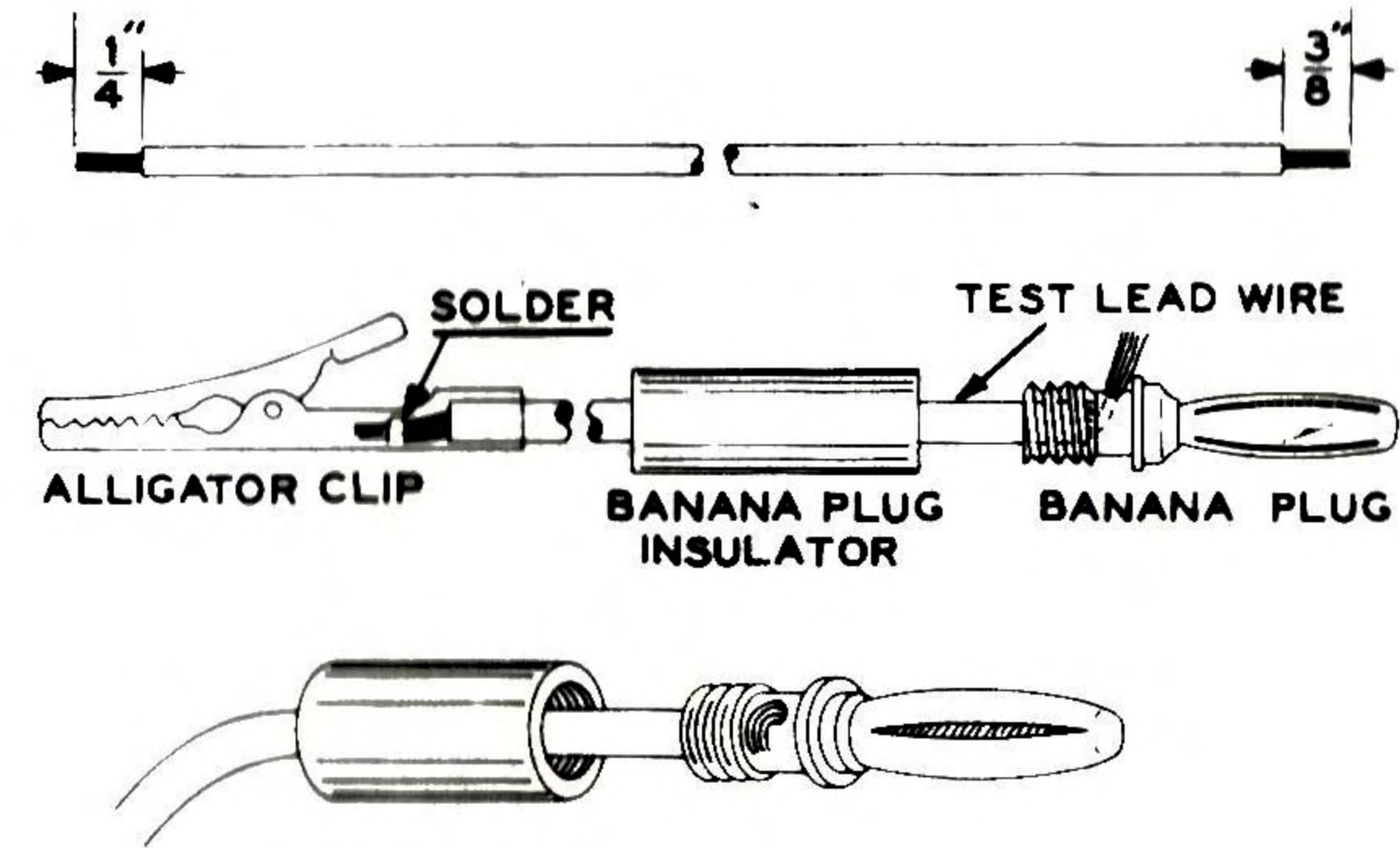

Detail 3B

This completes wiring. Check to see that all connections are soldered, and shake out any wire clippings or solder splashes.

**NOTE:** The blue and white identification label shows the Model Number and Production Series Number of your kit. Refer to these numbers in any communications with the Heath Company; this assures you that you will receive the most complete and up-to-date information in return.

- ( ) Carefully peel away the backing paper from the identification label. Then press the label into position on the inside of the case.
- ( ) Referring to Pictorial 4, install the case, using the 4-40 screws.

**NOTE:** The silver mica capacitors have a working voltage rating of 500 volts. The .15 and .22  $\mu$ fd capacitors are rated at 400 volts. All other capacitors have a rating of 600 volts. These ratings are all conservative; the capacitors can withstand intermittent overloads of as much as 200%.

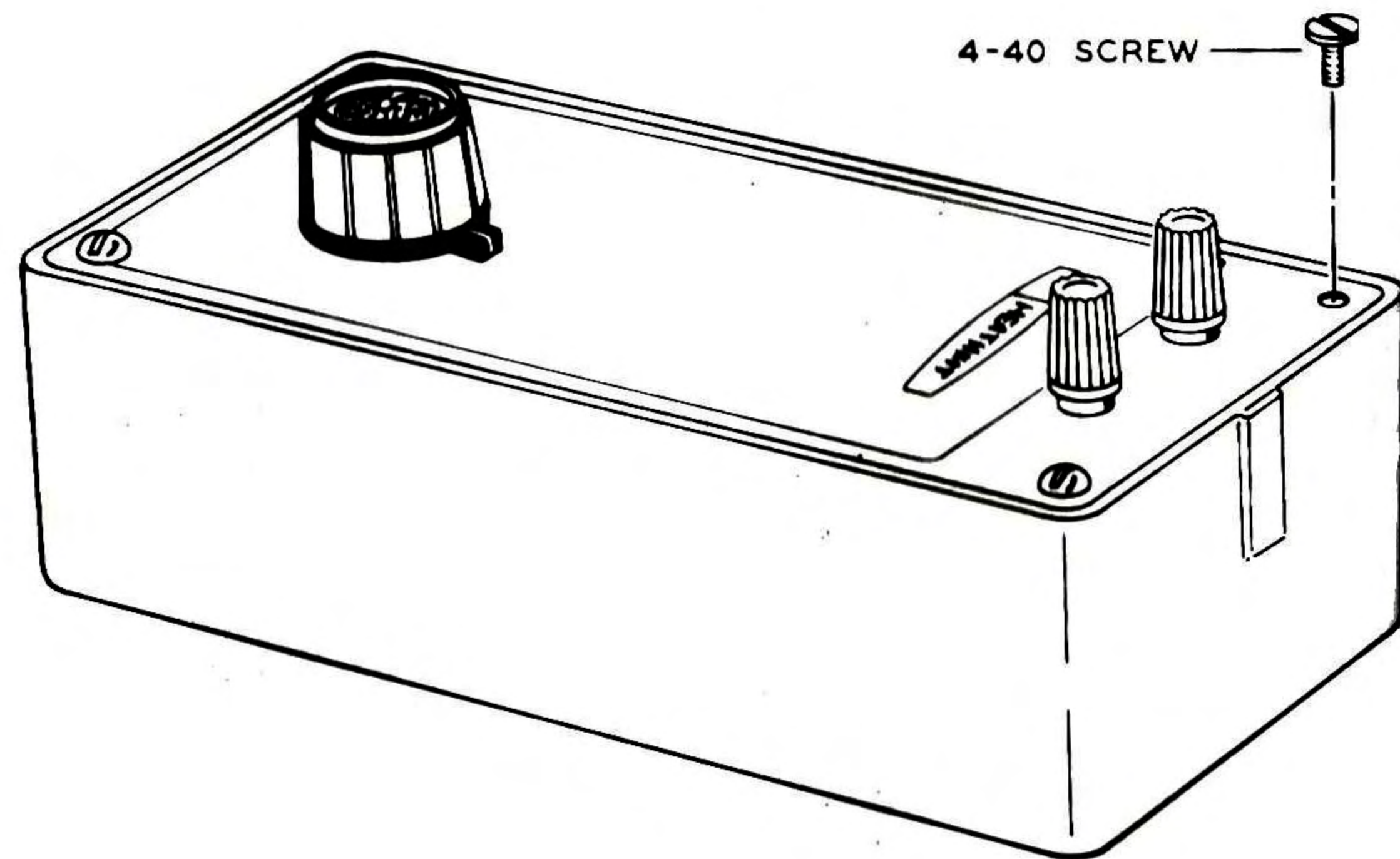

PICTORIAL 4

## IN CASE OF DIFFICULTY

1. Recheck the wiring. Trace each lead in colored pencil on the Pictorial as it is checked. It is frequently helpful to have a friend check your work. Someone who is not familiar with the unit may notice something consistently overlooked by the constructor.
  2. It is interesting to note that about 90% of the kits that are returned for repair do not function properly due to poor connections and soldering. Therefore, many troubles can be eliminated by reheating all connections to make sure that they are soldered properly.
  3. Check the values of the component parts. Be sure that the proper part has been wired into the circuit, as shown in the pictorial diagrams and as called out in the wiring instructions.
  4. Check for bits of solder, wire ends or other foreign matter which may be lodged in the wiring.
  5. Make sure the knob is properly installed. The value indicated by the knob pointer should correspond to the capacitor selected by the switch.
-

## REPLACEMENT PARTS PRICE LIST

To order parts, use the Parts Order Form furnished with this kit. If a Parts Order Form is not available, refer to "Replacement Parts" in the "Kit Builders Guide."

<u>PART</u> <u>No.</u>	<u>PRICE</u> <u>Each</u>	<u>DESCRIPTION</u>	<u>PART</u> <u>No.</u>	<u>PRICE</u> <u>Each</u>	<u>DESCRIPTION</u>
<b>CAPACITORS</b>			<b>HARDWARE</b>		
20-38	.20	.0001 $\mu$ fd (100 $\mu$ mf) mica	250-213	.05	4-40 screw
20-39	.20	.00022 $\mu$ fd (220 $\mu$ mf) mica	252-3	.05	6-32 nut
20-40	.20	.00047 $\mu$ fd (470 $\mu$ mf) mica	252-7	.05	Control nut
27-101	.15	.001 $\mu$ fd Mylar	253-1	.05	Fiber flat washer
27-102	.15	.0015 $\mu$ fd Mylar	253-2	.05	Fiber shoulder washer
27-103	.15	.0022 $\mu$ fd Mylar	253-10	.05	Control flat washer
27-91	.15	.0033 $\mu$ fd Mylar	254-4	.05	Control lockwasher
27-104	.20	.0047 $\mu$ fd Mylar	259-1	.05	Solder lug
27-105	.15	.0068 $\mu$ fd Mylar			
27-106	.15	.01 $\mu$ fd Mylar			
27-107	.15	.015 $\mu$ fd Mylar			
27-108	.15	.022 $\mu$ fd Mylar			
27-109	.20	.033 $\mu$ fd Mylar			
27-110	.20	.047 $\mu$ fd Mylar			
27-111	.25	.068 $\mu$ fd Mylar			
27-112	.30	.1 $\mu$ fd Mylar			
27-113	.30	.15 $\mu$ fd Mylar			
27-114	.30	.22 $\mu$ fd Mylar			
			<b>WIRE-SLEEVING</b>		
			341-1	.05/ft	Black test lead
			341-2	.05/ft	Red test lead
			344-59	.05/ft	Hookup wire
			346-1	.05/ft	Sleeving



<u>PART</u> <u>No.</u>	<u>PRICE</u> <u>Each</u>	<u>DESCRIPTION</u>
<b>MISCELLANEOUS</b>		
438-13	.20	Banana plug
70-5	.10	Black banana plug insulator
70-6	.10	Red banana plug insulator
427-2	.10	Binding post base
100-16-2	.10	Black binding post cap
100-16-18	.10	Red binding post cap
260-1	.15	Alligator clip
75-12	.10	Plastic insulator
63-451	2.40	18-position rotary switch
203-417-2	.30	Front panel
408-11	.80	Case
462-245	.60	Knob
455-50	.10	Knob bushing
213-2	.10	Capacitor connecting wire
331-6	.15	Solder
	2.00	Manual (See front cover for part number).

The above prices apply only on purchases from the Heath Company where shipment is to a U.S.A. destination. Add 10% (minimum 25 cents) to the price when ordering from an authorized Service Center or Heathkit Electronic Center to cover local sales tax, postage and handling. Outside the U.S.A. parts and service are available from your local Heathkit source and will reflect additional transportation, taxes, duties and rates of exchange.

## FACTORY REPAIR SERVICE

You can return your completed kit to the Heath Company Service Department to have it repaired for a minimum service fee. (Kits that have been modified will not be accepted for repair.) If you wish, you can deliver your kit to a nearby Heath Authorized Service Center. These centers are listed in your Heathkit catalog.

To be eligible for replacement parts under the terms of the warranty, equipment returned for factory repair service, or delivered to a Heath Authorized Service Center, must be accompanied by the invoice or the sales slip, or a copy of either. If you send the original invoice or sales slip, it will be returned to you.

If it is not convenient to deliver your kit to a Heath Authorized Service Center, please ship it to the factory at Benton Harbor, Michigan and follow the following shipping instructions:

Prepare a letter in duplicate, containing the following information:











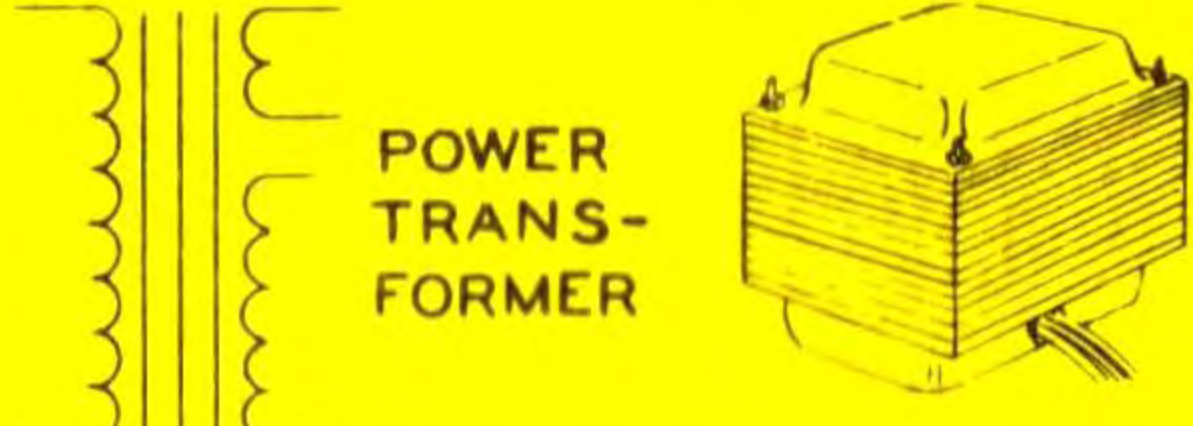

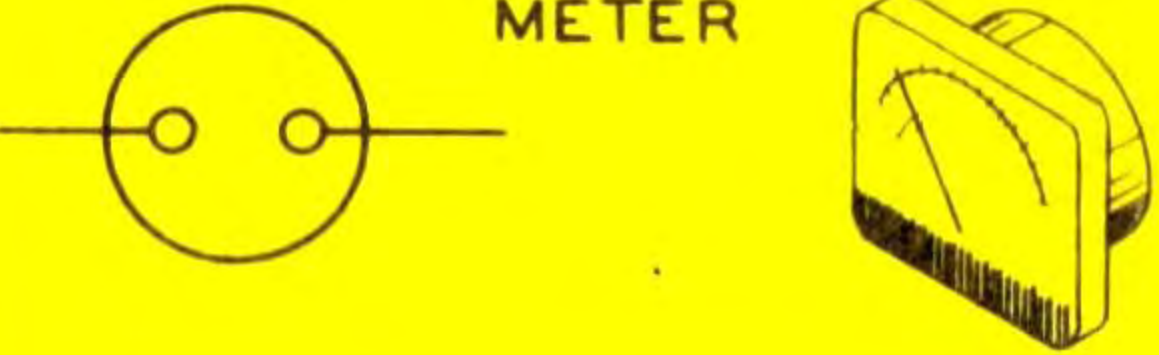

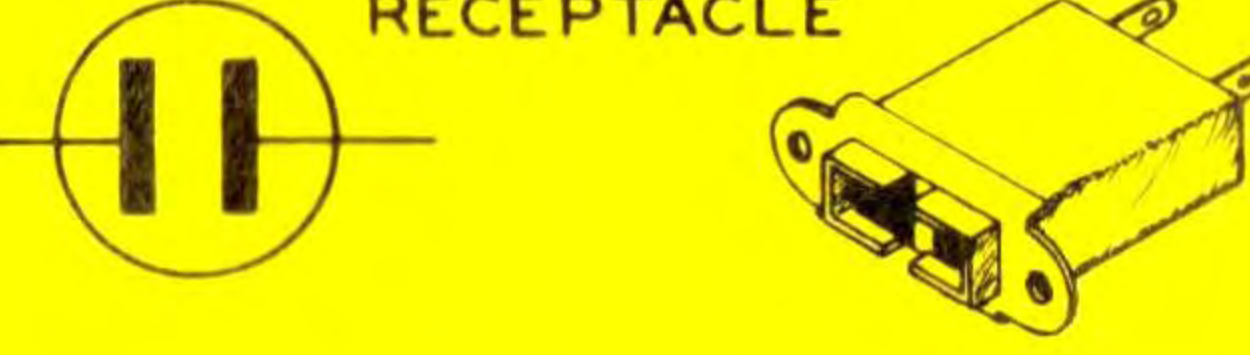
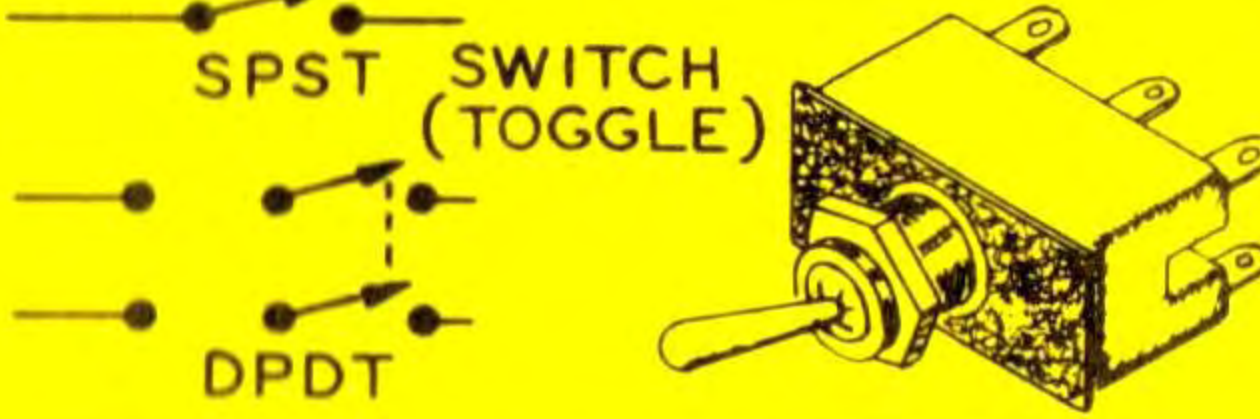
- Your name and return address.
- Date of purchase.
- A brief description of the difficulty.
- The invoice or sales slip, or a copy of either.
- Your authorization to ship the repaired unit back to you C.O.D. for the service and shipping charges, plus the cost of parts not covered by the warranty.

Attach the envelope containing one copy of this letter directly to the unit before packaging, so that we do not overlook this important information. Send the second copy of the letter by separate mail to Heath Company, Attention: Service Department, Benton Harbor, Michigan.

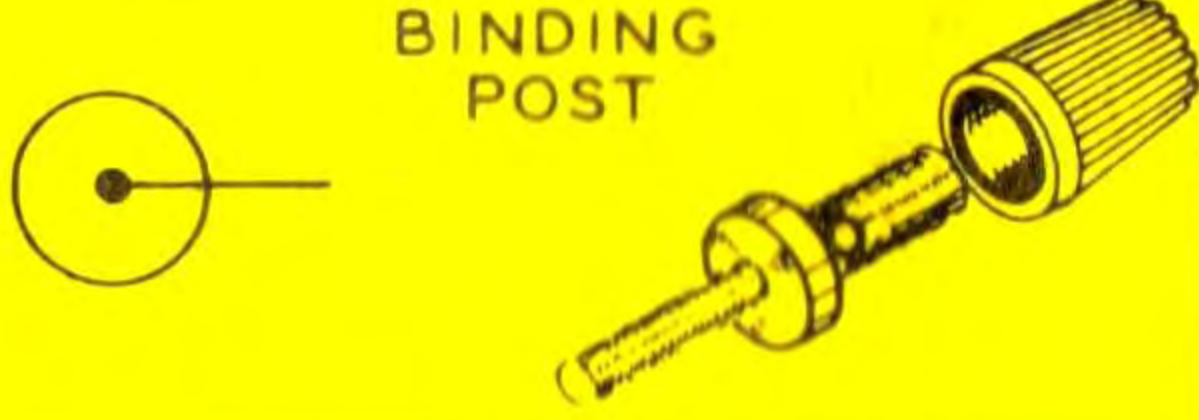
Check the equipment to see that all parts and screws are in place. (Do not include wooden cabinets when shipping receivers, tuners, amplifiers, or TV sets, as these are easily damaged in shipment.) Then, wrap the equipment in heavy paper. Place the equipment in a strong carton, and put at least THREE INCHES of resilient packing material (shredded paper, excelsior, etc.) on all sides, between the equipment and the carton. Seal the carton with gummed paper tape, and tie it with a strong cord. Ship it by prepaid express, United Parcel Service, or insured parcel post to:

Heath Company  
Service Department  
Benton Harbor, Michigan 49022

# TYPICAL COMPONENT TYPES

 <p>POWER TRANSFORMER</p>	 <p>PHONE JACK</p>	 <p>METER</p>
 <p>INDUCTOR (COIL)</p>	 <p>RECEPTACLE</p>	 <p>SPST SWITCH (TOGGLE) DPDT</p>
 <p>PIEZOELECTRIC CRYSTAL</p>	 <p>SPEAKER</p>	 <p>SWITCH (ROTARY)</p>
 <p>BINDING POST</p>	 <p>MICROPHONE</p>	 <p>FUSE</p>
 <p>ANTENNA GENERAL LOOP</p>	 <p>EARTH GROUND CHASSIS GROUND</p>	 <p>CONDUCTORS NOT CONNECTED CONNECTED SHIELDED</p>

# HEATH COMPANY

BENTON HARBOR, MICHIGAN

**THE WORLD'S FINEST ELECTRONIC EQUIPMENT IN KIT FORM**

LITHO IN U. S. A