

Introductory Guide

**RADIO COMMUNICATIONS TEST SET
2955A**

© Marconi Instruments Ltd. 1989

No part of this book may be reproduced or transmitted in any form or by any means, electronic or mechanical, including photocopying, or recorded by any information storage or retrieval system, without permission in writing by Marconi Instruments Ltd.

Printed in the UK

Part No. 46881-986A
Print code : A-7/89

CONTENTS

	Page
About this guide	3
Introduction	4
Preliminary actions	6
Tests on a transmitter	7
Tests on a receiver	15
Duplex tests	29
Audio tests	37
Signalling codes tests	43
Oscilloscope	49
Summary of indicators, controls and connectors	51

ABOUT THIS GUIDE

This is an introductory guide to the use of the 2955A in testing a mobile transceiver. There are examples of test procedures which show how easily the 2955A can measure and display a wide range of transmitter and receiver parameters. By following these examples, you can quickly learn about the capabilities and controls of the 2955A before you move on to the detailed information in the Operating Manual.

CONVENTIONS



This denotes a control key.



This denotes a toggle or rotary control.

AF INPUT Capital letters are used for connectors and for data on displays.

DUPLEX Bold type is used for the headings of displays.

Bold type is also used to highlight the first line of each step of a test sequence. In many cases, this is adequate to describe the action required. If not, then also read the supporting information which is printed below it in normal type.

ABBREVIATIONS

AC	alternating current
AF	audio frequency
AM	amplitude modulation
CRT	cathode-ray tube
dBR	dB relative to the entered level
dBV	dB relative to 1 V
DC	direct current
EMF	output level with no load
FM	frequency modulation
HF	high frequency (3 MHz to 30 MHz)
LED	light-emitting diode indicator
MF	medium frequency (300 kHz to 3 MHz)
PD	output level across the load
RF	radio frequency
RX	receiver
S/N	signal to noise
SINAD	signal + noise + distortion to noise + distortion
TX	transmitter
UHF	ultra-high frequency (300 MHz to 3 GHz)
VHF	very high frequency (30 MHz to 300 MHz)
ΦM	phase modulation

INTRODUCTION

MOBILE RADIO TESTING

Mobile radios come in many shapes and sizes from hand-held portables to remote-controlled installations. The frequency range may be MF, HF, VHF or UHF; operation may be simplex or duplex; modulation may be AM, FM or Φ M.

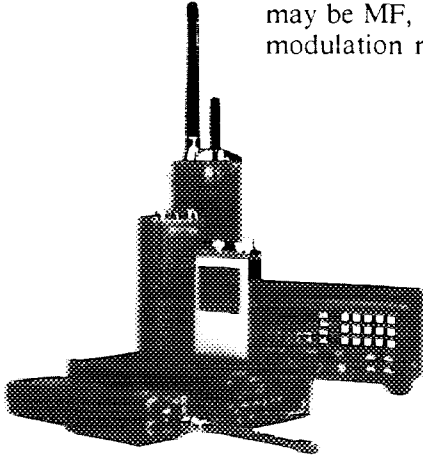

All, however, consist basically of a transmitter and/or a receiver and, to maintain them in their peak operating condition, the following are some of the routine tests which would be required:-

- Transmitter power.
- Transmitter frequency.
- Transmitter modulation.
- Transmitter distortion.
- Receiver sensitivity.
- Receiver bandwidth.
- Receiver audio frequency response.
- Receiver audio distortion.
- Receiver signal to noise ratio.

You could, of course, measure all these parameters in the conventional way by using individual instruments - a signal generator, frequency counters, a modulation meter and so on but you would need nearly a dozen items to do so.

Alternatively, you can achieve the same results with speed, convenience and economy by using a single purpose-built instrument - the Marconi Instruments Radio Communications Test Set 2955A.

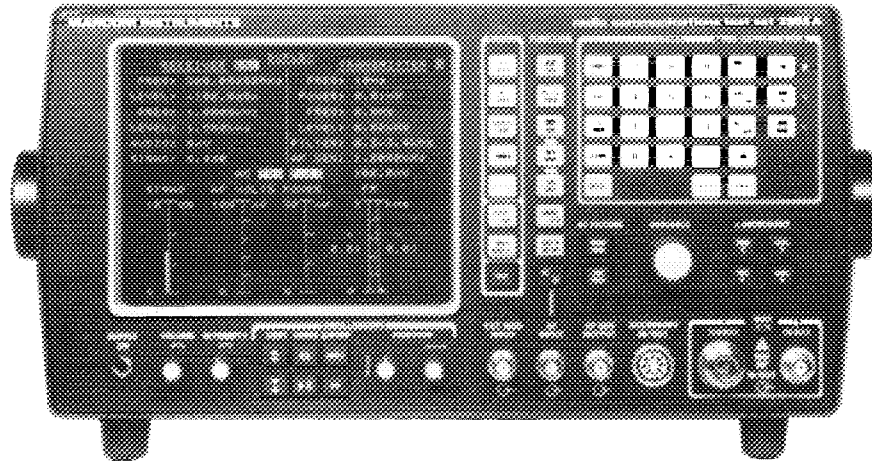

FEATURES OF THE 2955A

Radio Communications Test Set 2955A provides comprehensive test facilities for AM, FM and Φ M mobile radio transceivers operating up to 1000 MHz.

The 2955A is a combination of the following instruments:-

- RF power meter.
- DC and AF voltmeter.
- RF counter.
- AF counter.
- RF generator.
- AF generators (two).
- Modulation meter.
- AF distortion meter.
- S/N and SINAD meter.
- Sequential tones decoder and encoder.
- DTMF decoder and encoder.
- DCS decoder and encoder.
- POCSAG radio pager encoder.
- Digital oscilloscope.

These are automatically connected to the appropriate socket when an operating mode is selected.

A large CRT display shows all the generated and measured information for each test and a direct indication of the control settings being used.

The 2955A can be used to check a wide range of equipment including simplex and duplex radio telephones and mobiles using selective calling and cross-band repeaters.

PRELIMINARY ACTIONS

CONNECTIONS

- (1) Connect the 2955A to a suitable power supply by means of the supplied mains input lead or DC input lead.

See the Operating Manual Chap. 2 under 'Power supply requirements'.

- (2) On the radio under test, check that the battery is charged. If necessary, connect it to a suitable power supply.

SETTING THE CONTROLS ON THE 2955A

- (1) Push up **SUPPLY** to ON.

The RECEIVER TEST display appears on the screen.

- (2) Adjust the brightness of the display.

Rotate **INTENSITY** as required.

TESTS ON A TRANSMITTER

INTRODUCTION

When you are working in the transmitter (TX) test mode, the output from the radio under test is fed to the appropriate circuits in the 2955A. These are the RF counter and, according to which measurement you are taking, one of the following:-

- (a) The RF power meter.
- (b) The modulation meter and the AF counter.
- (c) The AF distortion meter.

For the modulation and distortion measurements, the output from the AF generator is fed to the radio under test.

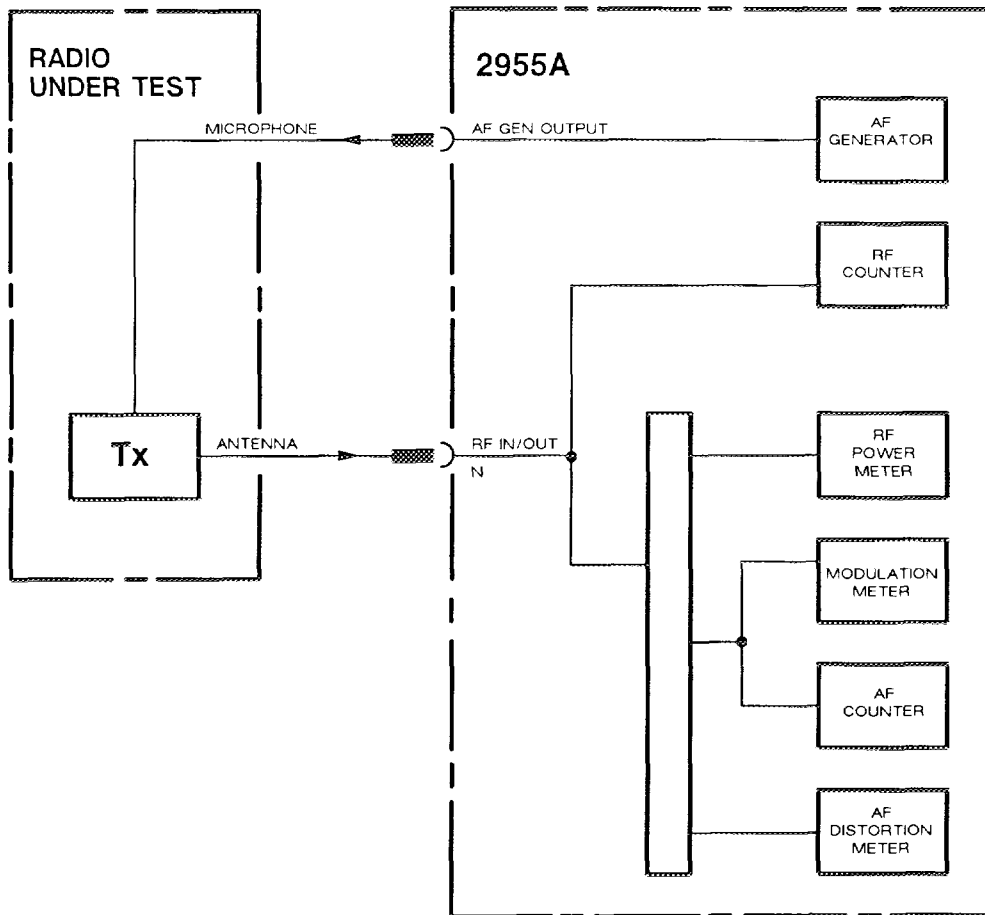

CONNECTIONS

- (1) On the radio under test, disconnect the antenna connection and connect a lead from it to the 2955A N type RF IN/OUT socket.

A wide variety of connectors is used for radios. The most common are PL289, TNC and N types. On some hand portables, BNC and SMA types are used. There is rarely any difficulty in identifying the correct type but it is wise to consult the radio handbook. If an incorrect type is used, an incorrect power reading may be given. Also, there could be damage to the connector and/or to the transmitter RF amplifier.

To measure only the RF power and frequency, the above connection is sufficient. To check modulation and distortion, simply whistling into the microphone while transmitting can give a modulation level of 100% AM or limiting deviation on FM. For precise modulation, you should use the 2955A AF generator.

- (2) When required, connect a lead from the radio's microphone connector to the 2955A BNC type AF GEN OUTPUT socket.

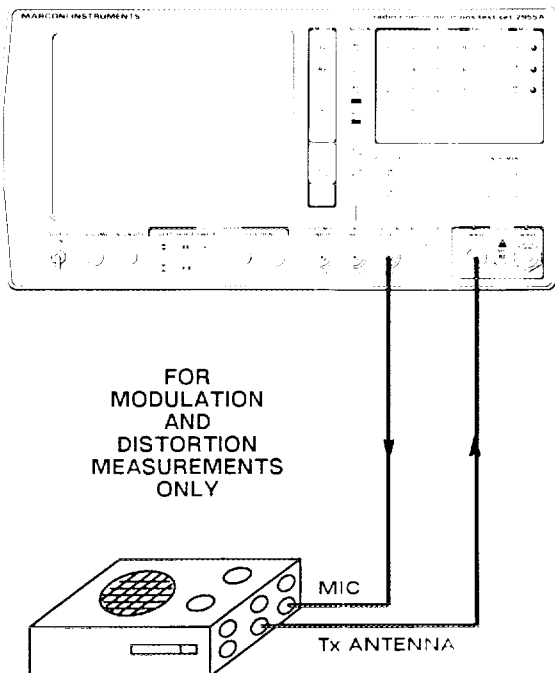

SETTING THE CONTROLS

For all tests on the transmitter, you have to start with the 'Preliminary actions' – see page 6 – and then proceed as below.

Select the transmitter test mode.

Press  (blue).

The **TRANSMITTER TEST** display appears on the screen.

The 2955A sets to default values, as shown on the screen as follows:-

Parameter	Value
AF frequency	1.0000 kHz
AF level	100.0 mV

The N type socket is automatically selected.

The LED is lit above this socket.

You can then proceed with RF power and frequency tests and, after setting the AF generator, with modulation and distortion tests.

RF POWER AND FREQUENCY MEASUREMENT

Key the transmitter.

The 2955A automatically tunes to the transmitter frequency and selects the appropriate power range.

The transmitter frequency and power measurements appear on the screen.

When the power input is excessive, a visual warning (REMOVE RF INPUT) appears on the screen and an audible alarm follows shortly later.

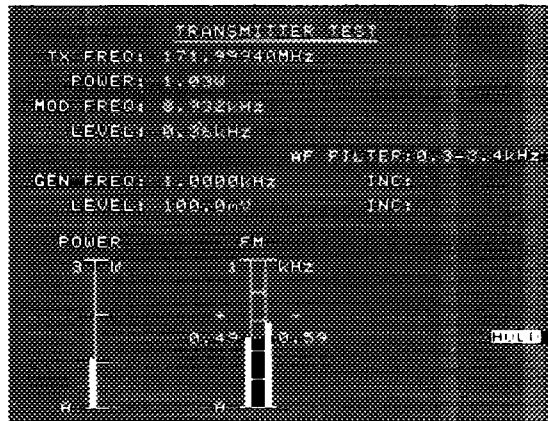



SETTING THE AF GENERATORS

When one or both of the AF generators are required for modulation measurements, operation consists of initial actions (1) and then, for one or both of the two AF generators, AF frequency setting (2) to (4), level setting (5) to (7) and increment settings (8) and (9).



(1) Select the AF generator setting.

Initially, the first AF generator is enabled and the second is OFF. In this case, press  (green).

This selects the first AF generator. GEN is shown in reverse video on the screen. To enable and disable this AF generator, press  (green).

When both AF generators are enabled, select the first by pressing  (green) followed by  (white).

GEN 1 is shown in reverse video on the screen. To enable and disable this AF generator, press  (green).

To select the second AF generator, press  (green) followed by  (white).

GEN 2 is shown in reverse video on the screen. To enable and disable this AF generator, press  (green).

(2) Select frequency setting.

Press  (orange).

On the screen, the previous frequency value is shown in reverse video.

(3) Enter the frequency value.

Press up to six of the data keys (white) in turn.



On the screen, the previous frequency value is deleted and each new digit appears.

If you make a mistake when entering this data, press

 and then press the correct key(s).

To return to the previous value, press .

(4) Select the frequency unit.

Press ,  or  (orange).

On the screen, the new frequency value is shown in reverse video.

To replace this value, start again at (3). This can be done at any time during a test provided the value is being shown in reverse video.

If it is not, press .

Instead of using the data keys, or after using them, the frequency can be adjusted by rotating .

(5) Select output level setting.

Press  (orange).

On the screen, the previous output level value is shown in reverse video.

(6) Enter the output level value.

Press up to five of the data keys (white) in turn.

On the screen, the previous output level value is deleted and each new digit appears.

If you make a mistake when entering this data, press



and then press the correct key.

To return to the previous value, press



(7) Select the output level unit.

Press , or (orange).

On the screen, the new output level value is shown in reverse video.

To replace this value, start again at (6). This can be done at any time during a test provided the value is being shown in reverse video.

If it is not, press .

Instead of using the data keys, or after using them, the output level can be adjusted by rotating .

You can increase or decrease the frequency and/or the output level in steps from the initial settings by using

, , and (brown).

Before you can use these keys, you have to set your steps (increments) as below.

(8) Select frequency or output level increment setting.

Press or followed by (orange).

(9) Enter the frequency as (3) and (4) and/or the output level as (6) and (7).



The increments which you have entered appear on the screen.

EXAMPLE 1.2340 kHz, 12.3 mV

In this example, 12.3 mV is shown on the screen. However, the AF generator steps are 1 mV (up to 255 mV) so the output level is actually 12 mV.

MODULATION MEASUREMENT

- (1) Select the type of modulation.

Press  ,  or  (orange).

The adjacent LED indicator comes on.

The appropriate bar chart appears on the screen.

- (2) When required, select a filter.

Press  (brown) for 0.3 to 3.4 kHz or press

 (brown) once or twice for up to 0.3 or 15 kHz.

The selected filter appears on the screen.

- (3) Key the transmitter.

The 2955A automatically tunes to the transmitter frequency and selects the appropriate power range.

The modulation frequency and modulation level measurements appear on the screen.

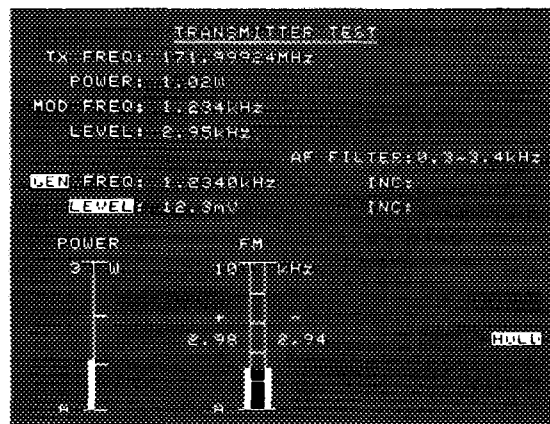

The demodulated output is fed to the following:-

- The BNC type DE-MOD OUT socket on the rear.
- The internal loudspeaker. The level can be adjusted by rotating  .
- The ACCESSORY IN/OUT socket on the front.



DISTORTION MEASUREMENT

- (1) Select the required modulation.

Press  ,  or  (orange).

The adjacent LED indicator comes on.

- (2) Select distortion measurement.

Press  (green).

DISTN: and the DISTN bar chart appear on the screen.

A modulation frequency of 1.0000 kHz is automatically selected.

- (3) When required, select a filter.

0.3 to 3.4 kHz is automatically selected.

For up to 0.3 or 15 kHz, press  (brown) once or twice.

The selected filter appears on the screen.

- (4) Key the transmitter.

The distortion measurement appears on the screen.

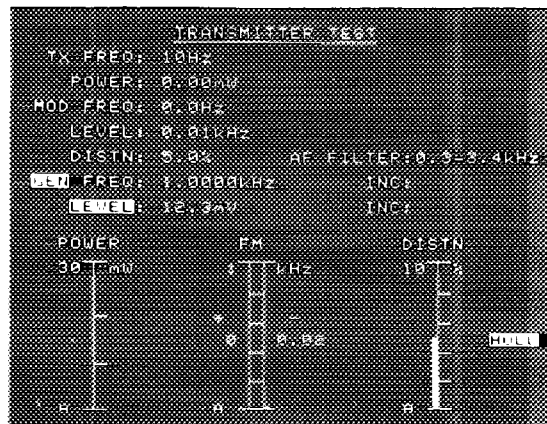

TESTS ON A RECEIVER

INTRODUCTION

When you are working in the receiver (RX) test mode, the output from the radio under test is fed to the appropriate circuits in the 2955A. These are, according to which measurement you are taking, one of the following:-

- (a) The AF voltmeter and the AF counter.
- (b) The AF distortion meter.
- (c) The S/N and SINAD meter.

The output from the AF generator modulates the RF generator. The output from the RF generator is fed to the radio under test.

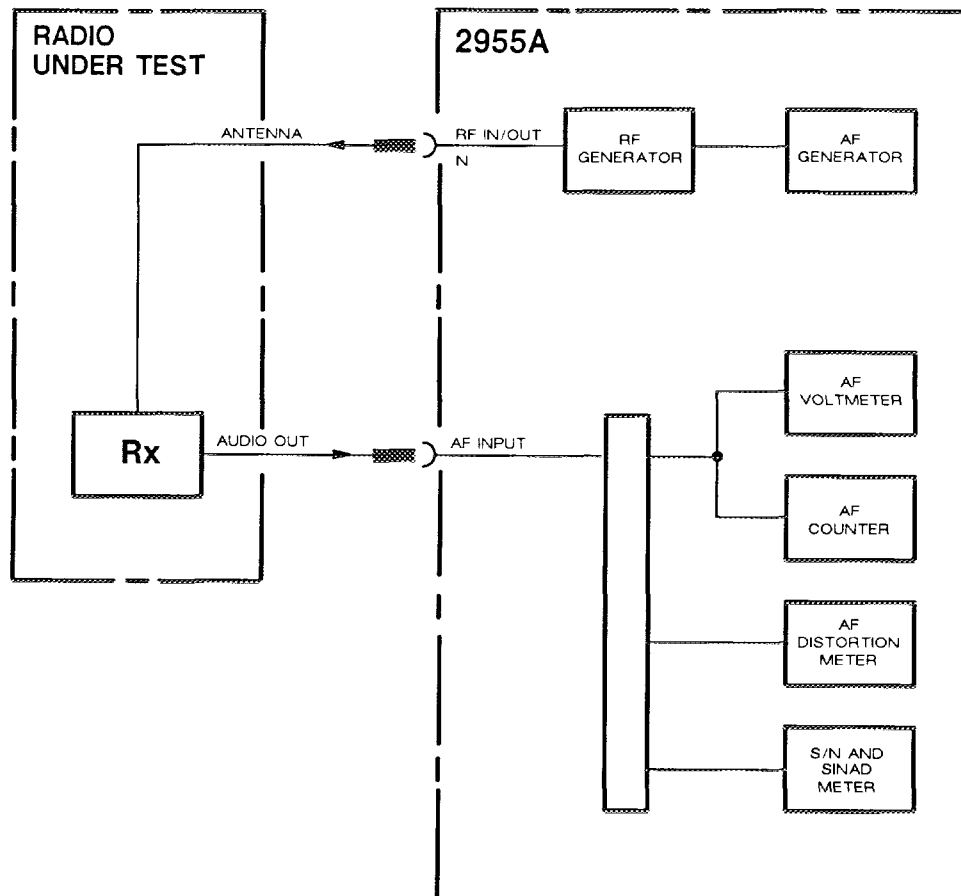

CONNECTIONS

- (1) On the radio under test, disconnect the antenna connection and connect a lead from it to the 2955A N type RF IN/OUT socket.

For notes about connectors – see page 8.

- (2) Connect a lead from the radio's audio output to the 2955A BNC type AF INPUT socket.

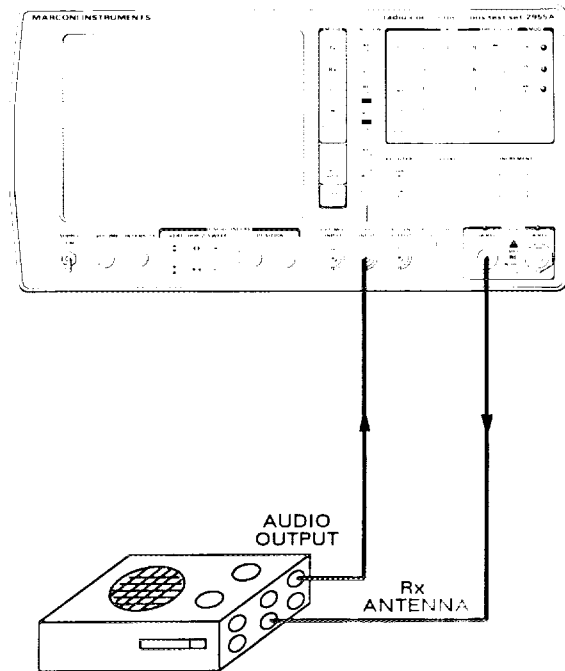

SETTING THE CONTROLS

For all tests on the receiver, you have to start with the 'Preliminary actions' - see page 6 - and then proceed as below.

Select the receiver test mode.

When it is first switched on, the 2955A goes into the **RECEIVER TEST** mode. If you have been using the 2955A in another test mode,

press  (blue).

The **RECEIVER TEST** display appears on the screen.

The 2955A sets to default values, as shown on the screen, as follows:-

Parameter	Value
RF generator frequency	300.00000 MHz
RF generator output level	-100.0 dBm
Modulation	FM
FM frequency	1.0000 kHz
FM deviation	1.500 kHz

The N type socket is automatically selected.

The LED is lit above this socket.

SETTING THE RF GENERATOR

The RF generator has to be set to the frequency which you have chosen for the receiver and the output has to be set to a suitable level.

(1) Select the RF generator.

Press  (green).

On the screen, GEN is shown in reverse video.

(2) Select frequency setting.

Press  (orange).

On the screen, FREQ is shown in reverse video.

(3) Enter the frequency value.

Press up to eight of the data keys (white) keys in turn.



On the screen, the previous frequency value is deleted and each new digit appears.

If you make a mistake when entering this data, press

 and then press the correct key.

To return to the previous value, press .

(4) Select the frequency unit.

Press ,  or  (orange).

The frequency unit which you have entered appears on the screen.

To replace the frequency value, start again at (3). This can be done at any time during a test provided FREQ is being shown in reverse video.

If it is not, press .

Instead of using the data keys, or after using them, the frequency can be adjusted by rotating .

(5) Select output level setting.

Press  (orange).

On the screen, LEVEL is shown in reverse video.

(6) Enter the output level value.

Press up to five of the data keys (white) in turn.

On the screen, the previous output level value is deleted and each new digit appears.

If you make a mistake when entering this data, press

 and then press the correct key.

To return to the previous value, press .

(7) Select the output level unit.

Press , , or dBm (orange).

The output level unit which you have entered appears on the screen.

To replace the output level value, start again at (3). This can be done at any time during a test provided LEVEL is being shown in

reverse video. If it is not, press .

Instead of using the data keys, or after using them, the output level can be adjusted by rotating .

If you have entered dBm and then press one of the voltage keys, the value is converted into a voltage. Similarly, if you have entered a voltage and then press the dBm key, the value is converted into dBm.

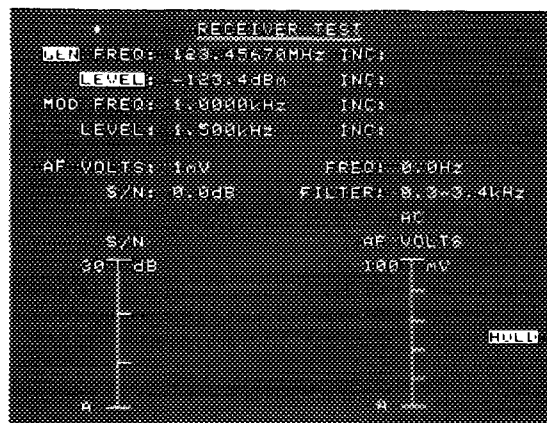

As supplied, each 2955A is programmed either for European or for North American standards. European practice is to show the output level as PD or EMF. To convert from PD to EMF or vice versa,

press . A menu appears on the screen.

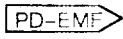
Press  and then  as required.



Press  to return to the RECEIVER TEST display.

You can increase or decrease the frequency and/or the output level in steps from the initial settings by using



Before you can use these keys, you have to set your steps (increments) as below.





















- (8) Select frequency or output level increment setting.

Press  or  followed by  (orange).



- (9) Enter the frequency as (3) and (4) and/or the output level as (6) and (7).

The increments which you have entered appear on the screen.

EXAMPLE 123.45670 MHz, -123.4 dBm

SETTING THE MODULATION

The modulation frequency is normally 1.0000 kHz. When you press  or , this frequency is automatically set.



After using either of these keys, you can reset the frequency as below. The output has to be set to a suitable level and AM, FM or Φ M has to be selected.

When one or both of the modulation generators are required for modulation, operation consists of initial actions (1) and then, for one or both of the two modulation generators, modulation frequency setting (2) to (4), level setting (5) to (7) and increment settings (8) and (9).



(1) Select modulation setting.

Initially, the first modulation generator is enabled and the second is OFF. In this case, press  (green).

This selects the first modulation generator. MOD is shown in reverse video on the screen. To enable and disable this modulation generator, press  (green).

When both modulation generators are enabled, select the first by pressing  (green) followed by  (white).

MOD 1 is shown in reverse video on the screen. To enable and disable this modulation generator, press  (green).

To select the second modulation generator, press  (green) followed by  (white).

MOD 2 is shown in reverse video on the screen. To enable and disable this modulation generator, press  (green).

(2) Select frequency setting.

Press  (orange).

On the screen, FREQ is shown in reverse video.

(3) Enter the frequency value.

Press up to six of the data keys (white) in turn.



On the screen, the previous value is deleted and each new digit appears.

If you make a mistake when entering this data, press

 and then press the correct key.

To return to the previous value, press .

(4) Select the frequency unit.

Press ,  or  (orange).

The frequency unit which you have entered appears on the screen.

To replace the frequency value, start again at (3). This can be done at any time during a test provided FREQ is being shown in reverse video.

If it is not, press .

Instead of using the data keys, or after using them, the frequency can be adjusted by rotating .

(5) Select modulation level setting.

Press  (orange).

On the screen, LEVEL is shown in reverse video.

(6) Enter the modulation level value.

Use up to five of the data keys (white) keys as in (3).

For FM, the value is the frequency deviation.

For AM, the value is the percentage depth.

For Φ M, the value is the deviation in radians.

On the screen, the previous output level value is deleted and each new digit appears.

If you make a mistake when entering this data, press

 and then press the correct key.

To return to the previous value, press .

(7) Select the modulation level unit and the type of modulation.

To select FM deviation, press  or  (orange).

To select AM percentage depth, press  (orange).

To select Φ M deviation, press  (orange).

Whichever modulation is selected, the adjacent LED indicator comes on.

The modulation level unit which you have entered appears on the screen.

To replace the modulation level value, start again at (6). This can be done at any time during a test provided LEVEL is being shown in

reverse video. If it is not, press .

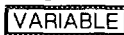

Instead of using the data keys, the modulation level can be adjusted by rotating .

You can increase or decrease the modulation frequency and/or the modulation level in steps from the initial settings by using

, ,  or  (brown).

Before you can use these keys, you have to set your steps (increments) as below.

(8) Select modulation frequency or modulation level increment setting.

Press  or  followed by  (orange).

(9) Enter the modulation frequency as (3) and (4) and/or the modulation level as (6) and (7).

The increments which you have entered appear on the screen.

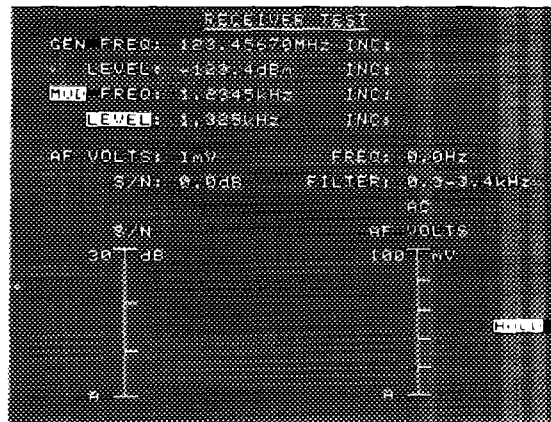
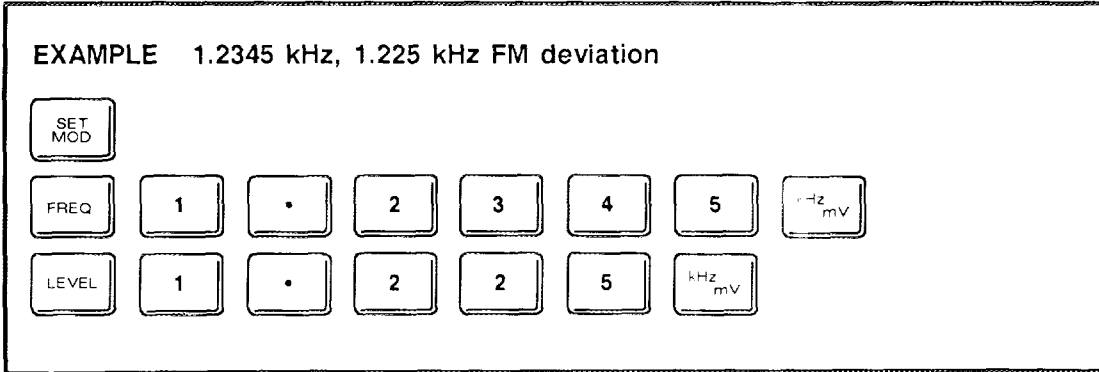

INTERNAL AND EXTERNAL MODULATION

Modulation is automatically selected.

To disable modulation, press .

On the screen, OFF is shown in reverse video.

To enable modulation, press again.

On the screen, OFF is deleted.

External modulation is added to the internal modulation.

When you wish to use external modulation only, set the internal modulation level to 0 kHz FM, 0% AM or 0 rad Φ M.

AUDIO VOLTAGE AND FREQUENCY MEASUREMENT

- (1) Select a voltage reading or a dB reading.

Press  (green) for a dBV or dBR reading.
dBV is automatically selected.

Press  (orange) for a dBR reading.

Press  again to return to a dBV reading.

- (2) Select AC or AC plus DC

AC is automatically selected.

AC is shown on the screen.

For AC plus DC (modulated DC) measurement, press

 (brown).

DC is shown on the screen.

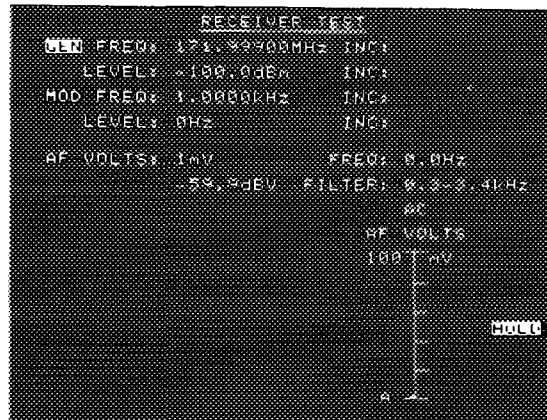

(3) When required, select a filter.

When DIST'N ON-OFF is used, 0.3 to 3.4 kHz is automatically selected. When AC DC is used, 50 kHz low-pass is automatically selected. When required, press  (brown).

For up to 0.3 or 50 kHz, press  (brown) once or twice.

The selected filter appears on the screen.

The voltage and frequency measurements appear on the screen.

DC may be positive or negative but this is not shown on the screen.

AUDIO DISTORTION AND NOISE MEASUREMENT

(1) Select distortion measurement.

Press  (green).

DISTN: and the DISTN bar chart appear on the screen.

A modulation frequency of 1.0000 kHz is automatically selected.

(2) When required, select a filter.

0.3 to 3.4 kHz is automatically selected. For up to 0.3 or 50 kHz, press  (brown) once or twice.

The selected filter appears on the screen.

The distortion measurement (in %) appears on the screen.

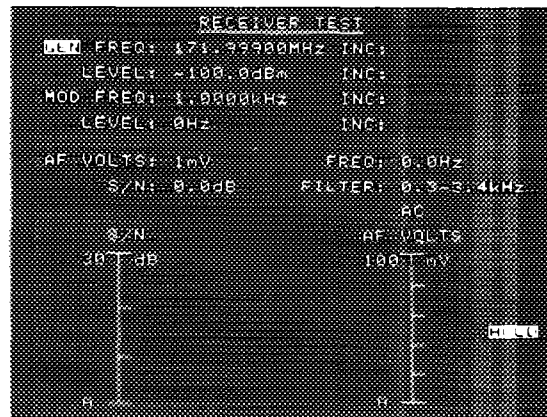

(3) Select SINAD measurement.

Press  (green).

SINAD: and the SINAD bar chart appear on the screen (replacing DISTN: and the DISTN bar chart).

A modulation frequency of 1.0000 kHz is automatically selected.

(4) When required, select a filter.

0.3 to 3.4 kHz is automatically selected. For up to 0.3 or 50 kHz,

press  (brown) once or twice.

The SINAD measurement (in dB) appears on the screen.

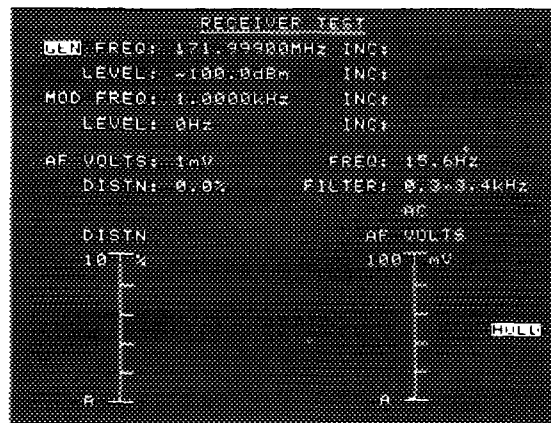

(5) Select S/N measurement.

Press  again.

SINAD: and the SINAD bar chart are replaced by S/N: and the S/N bar chart.

(6) When required, select a filter.

See (4).

The S/N measurement (in dB) appears on the screen.

Blank page.

DUPLEX TESTS

INTRODUCTION

When you are testing a duplex transceiver, the transmitter and the receiver can be tested together. Both are connected to the 2955A by means of one port or two ports.

One-port is for when you use a common antenna connection to the transmitter and the receiver (at the antenna side of a diplexer).

Two-port is for when you use separate antenna connections to the transmitter and the receiver, (at the transmitter and receiver side of a diplexer).

The output from the transmitter is fed to the RF power meter, to the RF counter and to the modulation meter.

The output from the receiver is fed, according to which measurement you are taking, to one of the following:-

- (a) The AF voltmeter and the AF counter.
- (b) The AF distortion meter.
- (c) The S/N and SINAD meter.

The output from the AF generator is fed to the transmitter or, for the distortion and noise tests, to the RF generator.

The output from the RF generator is fed to the receiver.

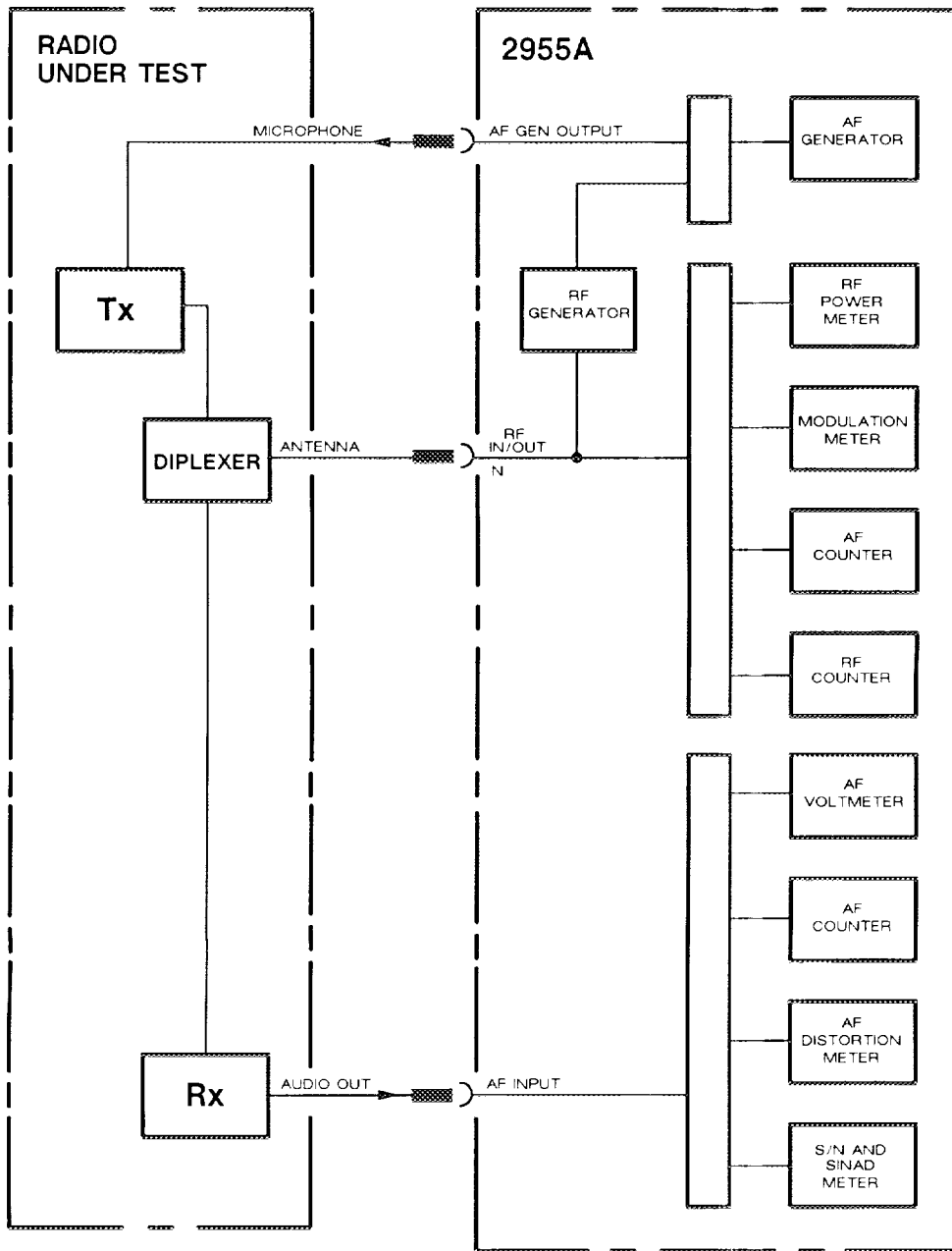

One-port configuration

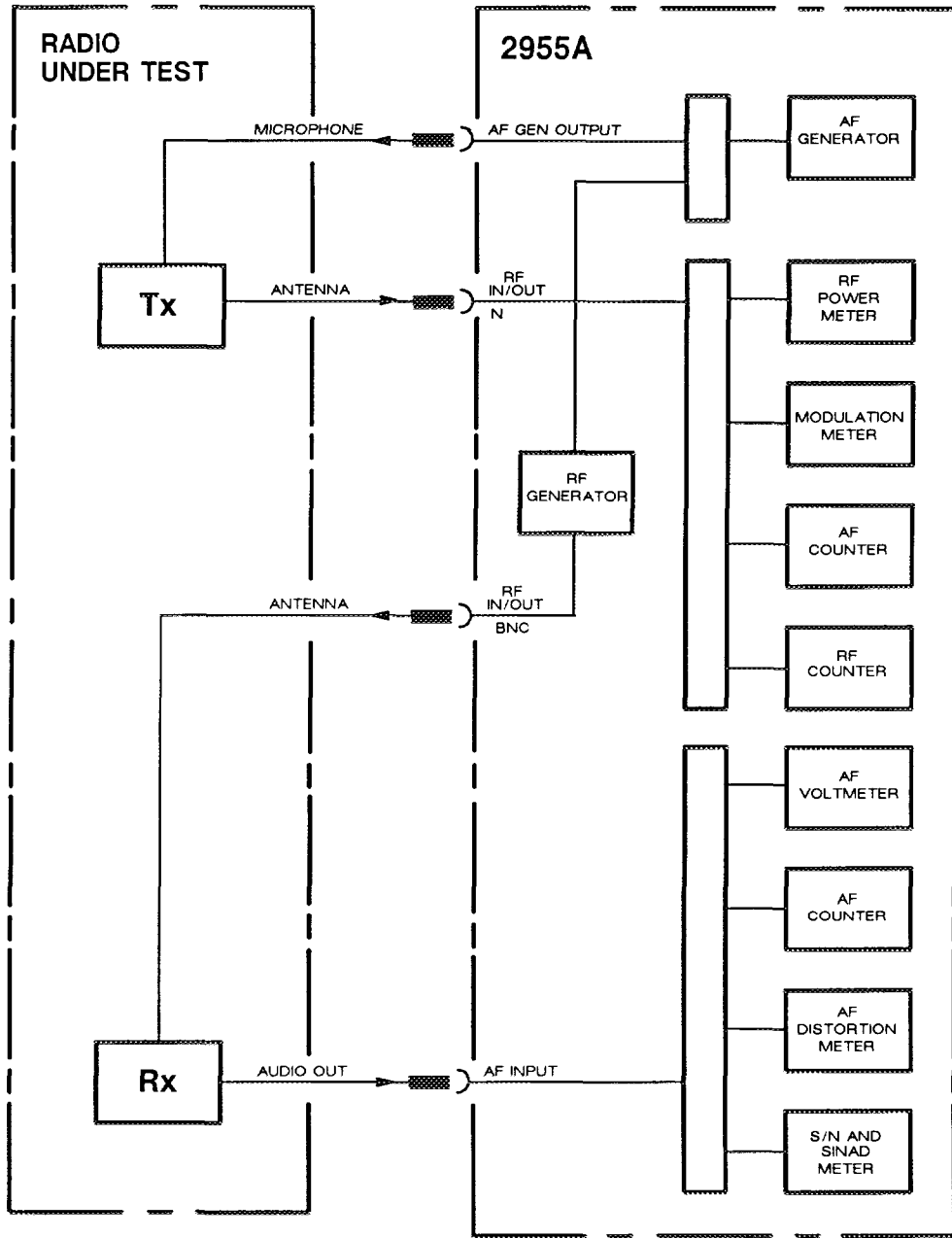

Two-port configuration

CONNECTIONS

- (1) On the transceiver under test, disconnect the common antenna connection for one-port configuration or the transmitter antenna connection for two-port configuration and connect a lead from it to the 2955A N type RF IN/OUT socket.

For notes about connectors – see page 8.

- (2) For two-port configuration, disconnect the receiver antenna connection and connect a lead from it to the 2955A BNC type RF IN/OUT socket.
- (3) Connect a lead from the transmitter's microphone connector to the 2955A BNC type AF GEN OUTPUT socket.
- (4) Connect a lead from the receiver's audio output to the 2955A BNC type AF INPUT socket.

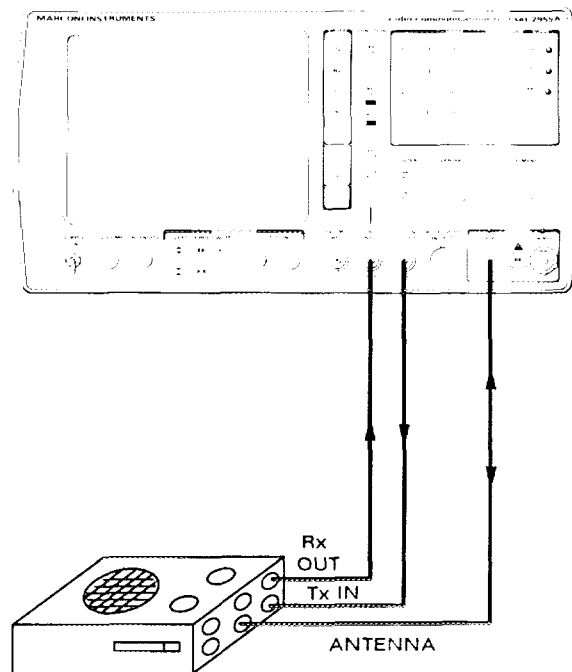

One-port connections

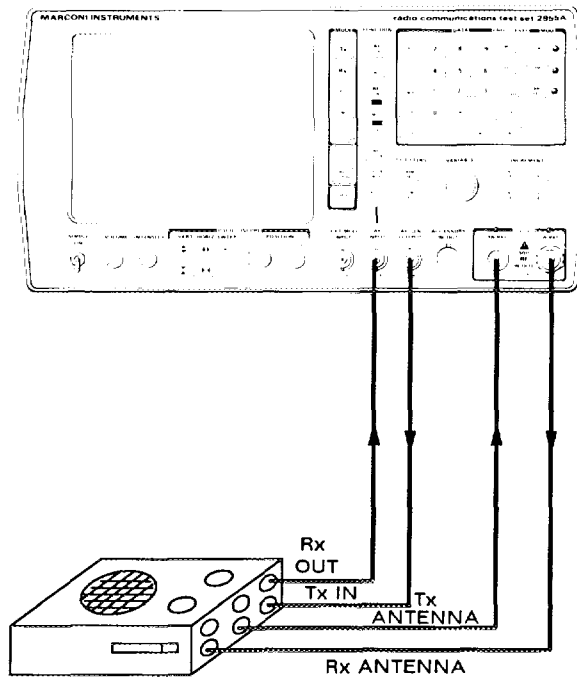

Two-port connections

SETTING THE CONTROLS

For all duplex tests, you have to start with the 'Preliminary actions' – see page 6 – and then proceed as below.

- (1) **Select the duplex test mode.**

Press  (blue).

The **DUPLEX** test display appears on the screen.

- (2) **Select one-port or two-port configuration.**

Two-port configuration is automatically selected.

On the screen, TWO PORT is shown in reverse video.

For one-port configuration, press  (brown).

On the screen, ONE PORT is shown in reverse video.

For two ports, BNC is shown in reverse video beside **RECEIVER** and N is shown in reverse video beside **TRANSMITTER**. This reminds you which sockets are to be used.

For one port, the LED is lit above the N type RF IN/OUT socket. For two ports, the LEDs are lit above both the N type and the BNC type sockets. This also reminds you which sockets are to be used.

TRANSMITTER TESTS

(1) **Set the AF generator.**

The frequency is fixed at 1kHz.

Set the output level as in 'Tests on a transmitter' – see page 9.

The type of modulation is determined by that set under 'Receiver tests' below.

(2) **Key the transmitter.**

The 2955A automatically tunes to the transmitter frequency and selects the appropriate power range.

The transmitter frequency and power measurements appear on the screen.





When the power input is excessive, a visual warning (REMOVE RF INPUT) appears on the screen and an audible alarm follows shortly later.

The modulation frequency and modulation level measurements appear on the screen.

RECEIVER TESTS



(1) **Set the RF generator.**

Set the frequency and the output level as in 'Tests on a receiver' – see page 16.

 ,  ,  and  can only be used when they have previously been set in the RX mode – see page 18.

A quick way of setting the frequency is to press

 (green). This sets the RF generator to the frequency of the transmitter.

Then press  or  which has previously been set to the receiver offset frequency.

(2) Set the modulation.

The modulation frequency is fixed at 1 kHz.

Set the modulation level as in 'Tests on a receiver' – see page 20.

(3) Select a voltage reading or a dB reading.

Press  (green) for a dBV or dBR reading.

dBV is automatically selected.

Press  (orange) for a dBR reading.

Press  again to return to a dBV reading.

(4) Select AC or AC plus DC

AC is automatically selected.

AC is shown on the screen.

For AC plus DC (modulated DC) measurement, press

 (brown).

DC is shown on the screen.

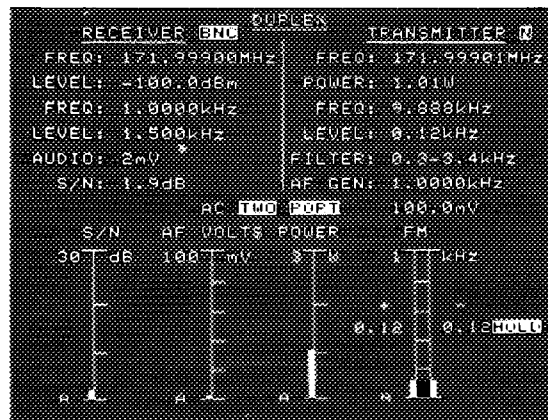

(5) **When required, select a filter.**

When DIST'N ON-OFF is used, 0.3 to 3.4 kHz is automatically selected. When AC DC is used, 50 kHz low pass is automatically selected. When required, press  (brown).

For up to 0.3 or 50 kHz, press  (brown) once or twice.

The selected filter appears on the screen under **TRANSMITTER**. The voltage and frequency measurements appear on the screen. DC may be positive or negative but this is not shown on the screen.

(6) **Select distortion measurement.**

Press  (green).

DISTN: and the DISTN bar chart appear on the screen. The RF signal to the receiver is then modulated by 1 kHz from the AF generator. The distortion measurement (in %) appears on the screen.

(7) **Select SINAD measurement.**

Press  (green).

SINAD: and the SINAD bar chart appear on the screen (replacing DISTN: and the DISTN bar chart). The SINAD measurement (in dB) appears on the screen.

(8) **Select S/N measurement.**

Press  again.

SINAD: and the SINAD bar chart are replaced by S/N: and the S/N bar chart. The S/N measurement (in dB) appears on the screen.

AUDIO TESTS

INTRODUCTION

When the AF generator is enabled in the receiver test mode, you can test an item of audio equipment (e.g. an amplifier or a filter).

The output from the equipment under test is fed to the appropriate circuits in the 2955A. These are, according to which measurement you are taking, one of the following:-

- (a) The AF voltmeter and the AF counter.
- (b) The AF distortion meter.

The output from the AF generator is fed to the equipment under test.

In this configuration, SINAD S/N is inoperative.

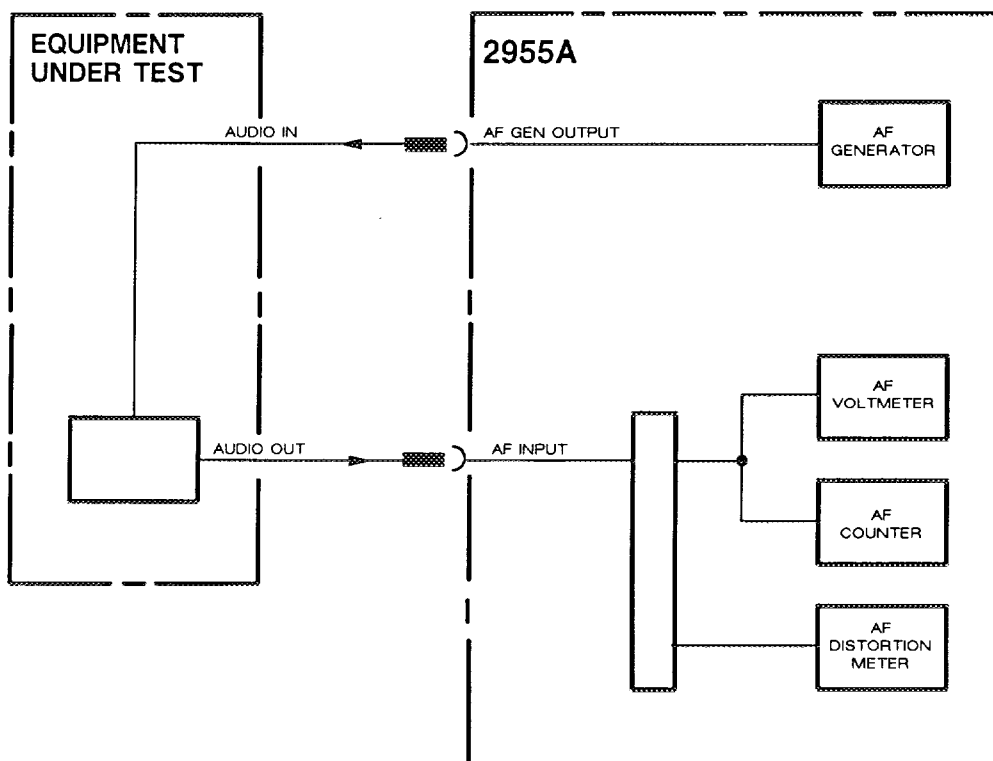

CONNECTIONS

- (1) Connect a lead from the equipment's input to the 2955A BNC type AF GEN OUTPUT socket.

For notes about connectors – see page 8.

- (2) Connect a lead from the equipment's output to the 2955A BNC type AF INPUT socket.

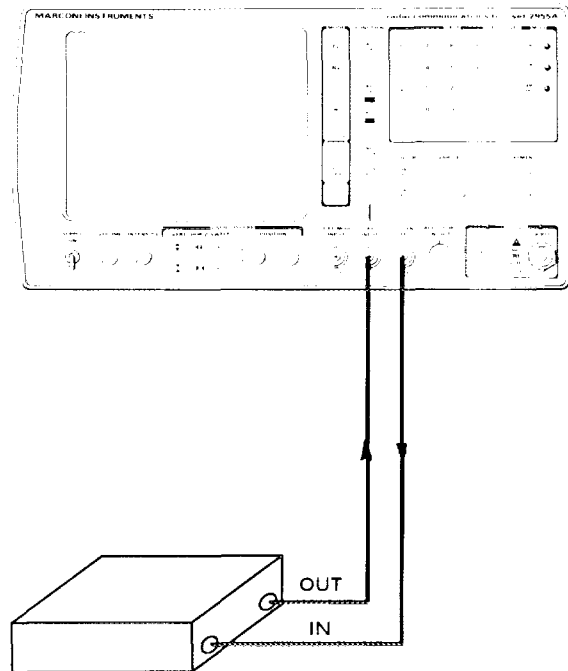

SETTING THE CONTROLS

For the audio tests, you have to start with the 'Preliminary actions' – see page 6 – and then proceed as below.

(1) Select the receiver test mode.



When it is first switched on, the 2955A goes into the receiver test mode. If you have been using the 2955A in another test mode,

press  (blue).



(2) Select the AF generator.

Press  (green).

The **AUDIO TEST** display appears on the screen. Initially, the first AF generator is selected. GEN 1 is shown in reverse video on the screen. To enable and disable this AF generator, press  (green).

To select the second AF generator, press  (green) followed by  (white).

GEN 2 is shown in reverse video on the screen. To enable and disable this AF generator, press  (green).

After the second AF generator has been selected, select the first again by pressing  (green) followed by  (white).

SETTING THE AF GENERATOR

(1) Select frequency setting.

Press  (orange).

On the screen, the previous frequency value is shown in reverse video.

(2) Enter the frequency value.



Press up to six of the data keys (white) in turn.

On the screen, the previous frequency value is deleted and each new digit appears.

If you make a mistake when entering this data, press the  key and then press the correct key.

To return to the previous value, press .

(3) Select the frequency unit.

Press  or  (orange).

On the screen, the new frequency value is shown in reverse video.

To replace this value, start again at (2). This can be done at any time during a test provided the value is being shown in reverse video.

If it is not, press .

Instead of using the data keys, or after using them, the frequency can be adjusted by rotating .

(4) Select output level setting.



Press  (orange).

On the screen, the previous output level value is shown in reverse video.

(5) Enter the output level value.

Use up to five of the data keys (white) as in (2).

(6) Select the output level unit.



Use ,  or  (orange) as in (3).

You can increase or decrease the frequency and/or the output level in steps from the initial settings by using

, ,  or  (brown).

Before you can use these keys, you have to set your steps (increments) as below.

(7) Select frequency or output level increment setting.

Press  or  followed by  (orange).

(8) Enter the frequency as (2) and (3) and/or the output level as (5) and (6).

The increments which you have entered appear on the screen. For output level adjustments finer than that of the last key, rotate

.

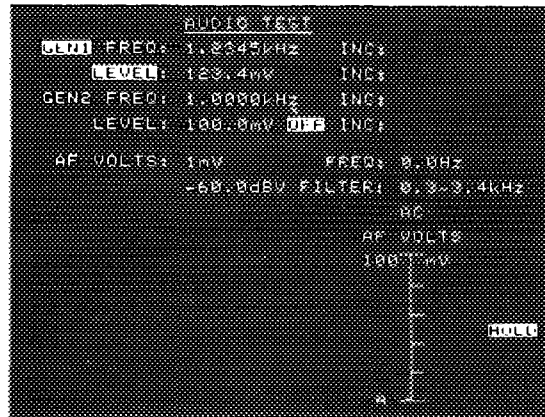



AUDIO VOLTAGE AND FREQUENCY MEASUREMENT

- (1) Select a voltage reading or a dB reading.

Press  (green) for a dBV or dBR reading.

dBV is automatically selected.

Press  (orange) for a dBR reading.

Press  again to return to a dBV reading.

- (2) Select AC or AC plus DC

AC is automatically selected.

AC is shown on the screen.

For AC plus DC measurement, press  (brown).

DC is shown on the screen.

- (3) When required, select a filter.

When **DIST'N ON-OFF** is used, 0.3 to 3.4 kHz is automatically selected. When **AC DC** is used, 50 kHz low-pass is automatically

selected. When required, press  (brown).

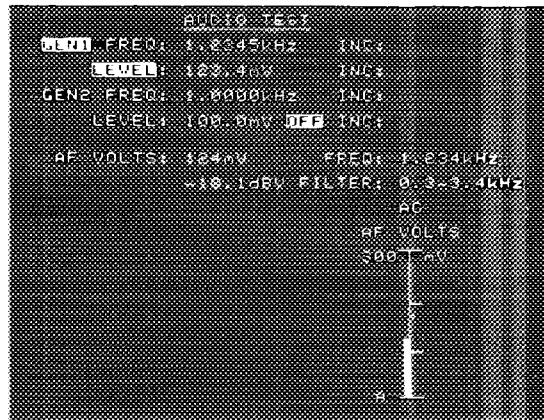

For up to 0.3 or 50 kHz, press  (brown) once or twice.
The selected filter appears on the screen.
The voltage and frequency measurements appear on the screen.

AUDIO DISTORTION

- (1) Enable distortion measurement.

Press  (green).

DIST'N: and the DISTN bar chart appear on the screen.

An AF generator frequency of 1.0000 kHz is automatically selected.

- (2) When required, select a filter.

0.3 to 3.4 kHz is automatically selected. For up to 0.3 or 50 kHz, press  (brown) once or twice.

The selected filter appears on the screen.

The distortion measurement (in %) appears on the screen.

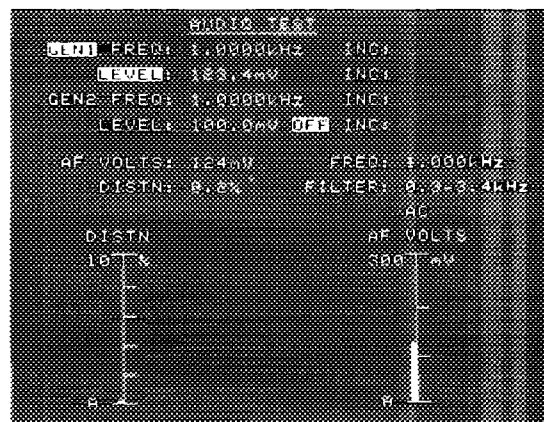

SIGNALLING CODES TESTS

SEQUENTIAL TONES

The 2955A is able to decode and encode selective calling tones. The frequencies are in accordance with four different standards – CCIR, ZVEI, DZVEI and either EEA (European) or EIA (North American).

When you are testing a transmitter, the output from the radio under test is fed through the modulation meter circuit to the tones decoder.

When you are testing a receiver, the output from the tones encoder is fed through the RF generator to the radio under test.

The testing procedures are not included in this Introductory Guide – see under 'Sequential tones operation' in the Operating Manual.

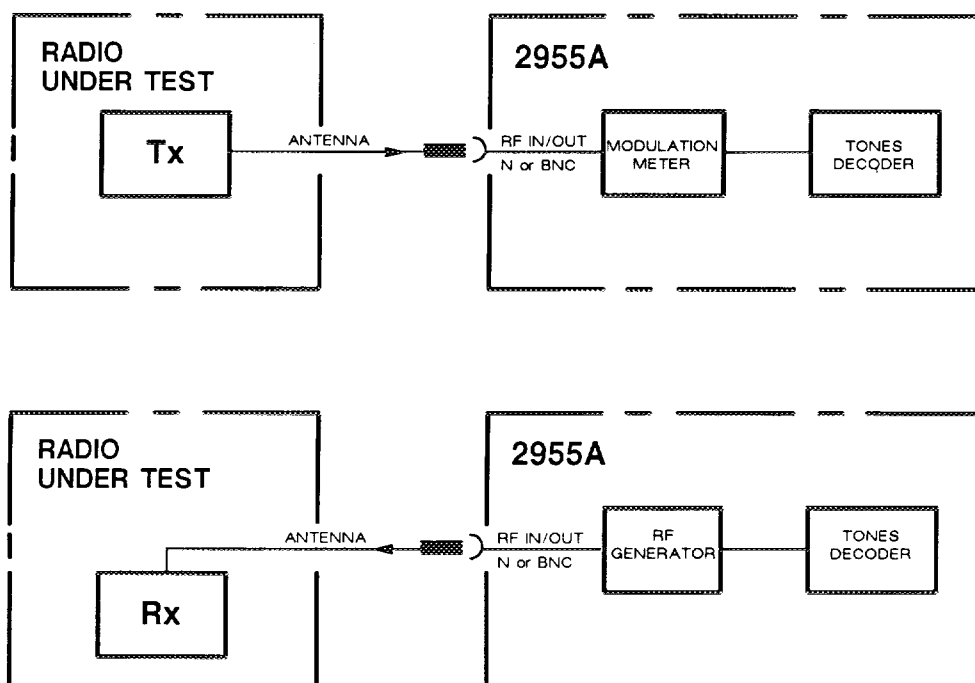

REVERTIVE SEQUENTIAL TONES

The 2955A generates a sequential tones sequence for sending to the radio under test.

In the radio under test, the sequential tones sequence is decoded by the receiver and the transmitter produces an answering sequence.

The 2955A decodes the signal which is received from the transmitter.

The testing procedures are not included in this Introductory Guide – see under ‘Revertive sequential tones operation’ in the Operating Manual.

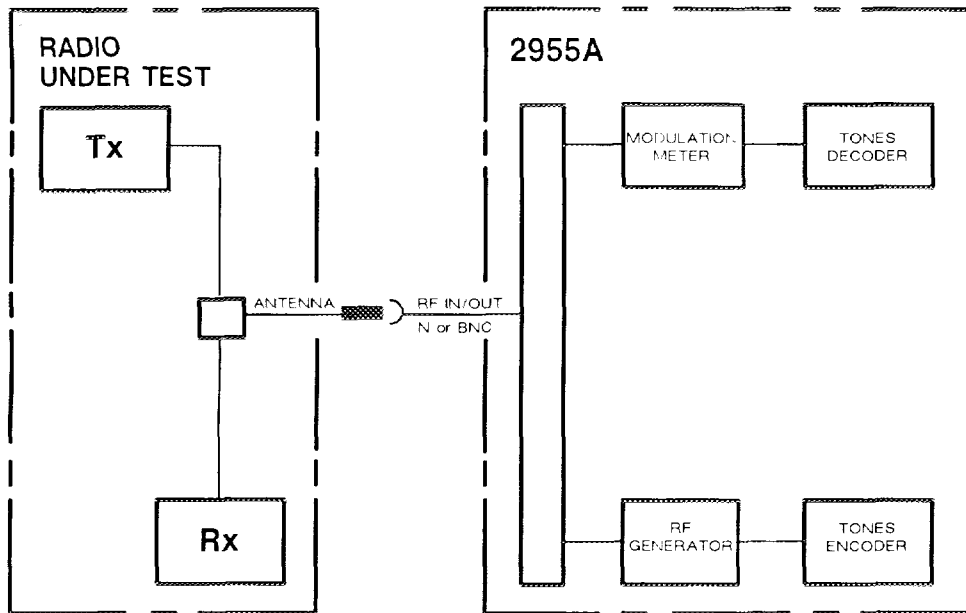

DTMF (DUAL-TONE MULTI-FREQUENCY)

The 2955A is able to decode and encode DTMF tones.

When you are testing a transmitter, the 2955A generates a DTMF sequence which is fed to the transmitter. The transmitter produces an RF signal which is modulated by the DTMF sequence. The 2955A decodes the signal which is received from the transmitter.

When you are testing a receiver, the 2955A generates a DTMF sequence which modulates the RF signal which is fed to the receiver. The receiver produces a demodulated AF signal. The 2955A decodes the AF signal which comes from the receiver.

The testing procedures are not included in this Introductory Guide - see under 'DTMF (dual-tone multi-frequency) operation' in the Operating Manual.

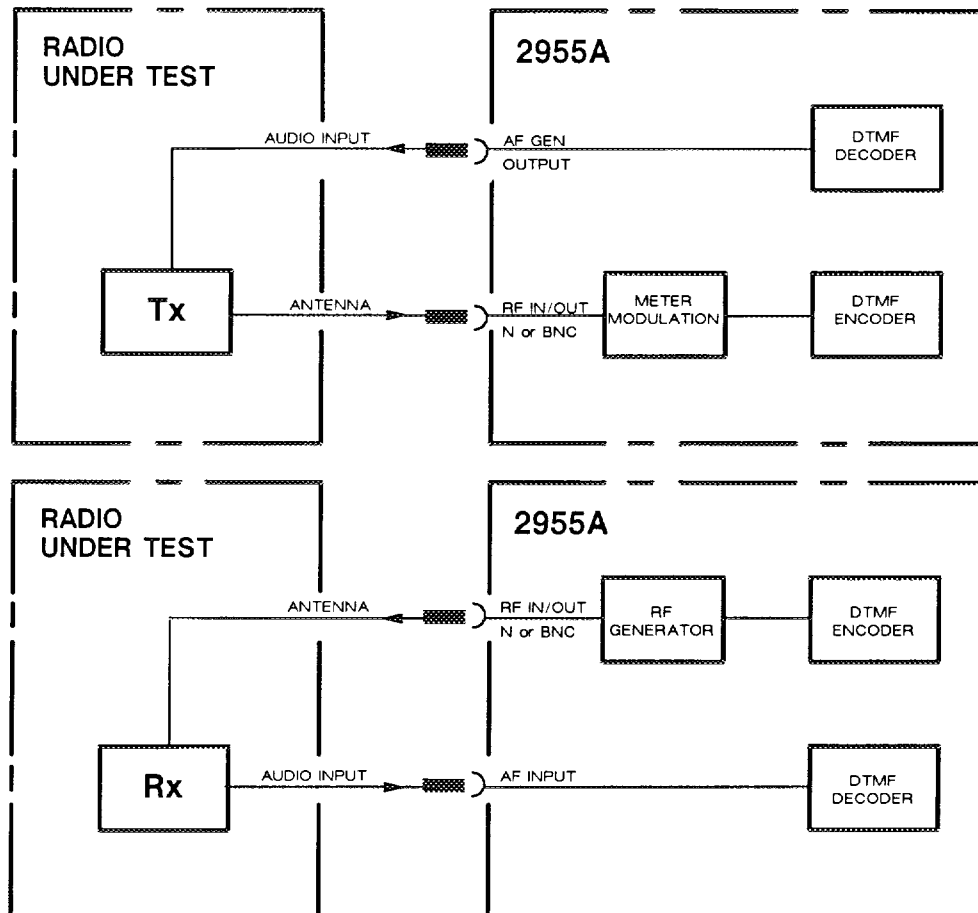

DCS (DIGITALLY CODED SQUELCH)

The 2955A is able to decode and encode DCS signals.

When you are testing a transmitter, the transmitter produces a modulated RF signal. The 2955A decodes the signal which is received from the transmitter.

When you are testing a receiver, the 2955A produces a DCS signal which modulates the RF generator.

The testing procedures are not included in this Introductory Guide – see under 'DCS (digitally-coded squelch) operation' in the Operating Manual.

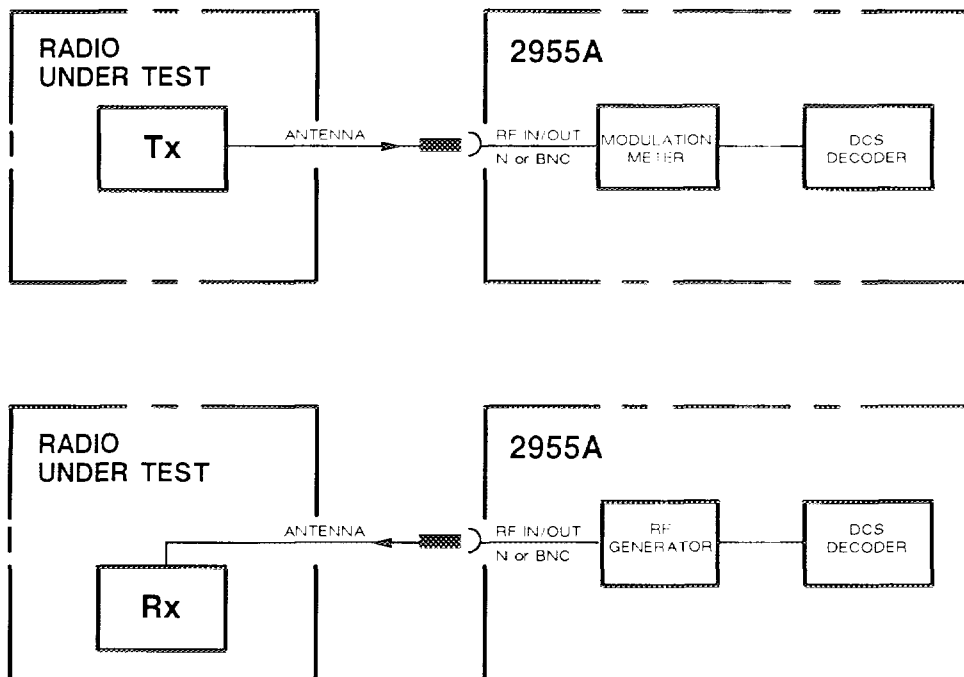

POCSAG RADIO PAGER

The 2955A is able to produce POCSAG paging signals.

The 2955A transmits paging signals from the Telescopic Antenna which is available as an optional accessory.

The testing procedures are not included in this Introductory Guide - see under 'POCSAG (radio pager testing) operation' in the Operating Manual.

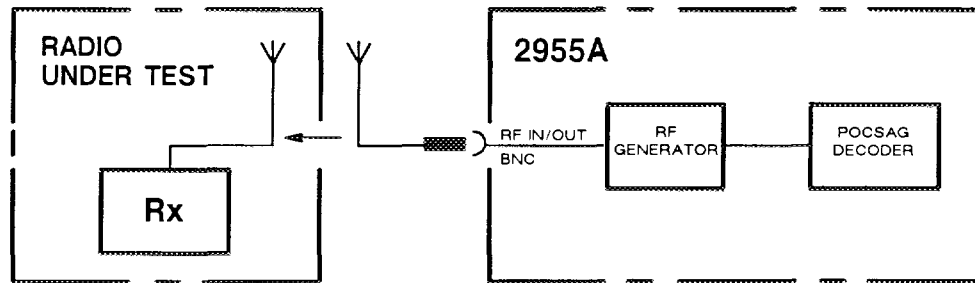

Blank page.

OSCILLOSCOPE

INTRODUCTION

As an alternative to the bar charts on the bottom halves of the **TRANSMITTER TEST** and the **RECEIVER TEST** displays, the 2955A can produce an oscilloscope display. There are six vertical divisions and ten horizontal divisions.

In the transmitter test mode, the trace shows the demodulated output.

In the receiver test mode, the trace shows the audio signal from the receiver.

SETTING THE CONTROLS

To use the oscilloscope, go through the following steps:-

- (1) Select the oscilloscope.

Press  (blue).

To return to the bar charts at any time, press

 (blue).

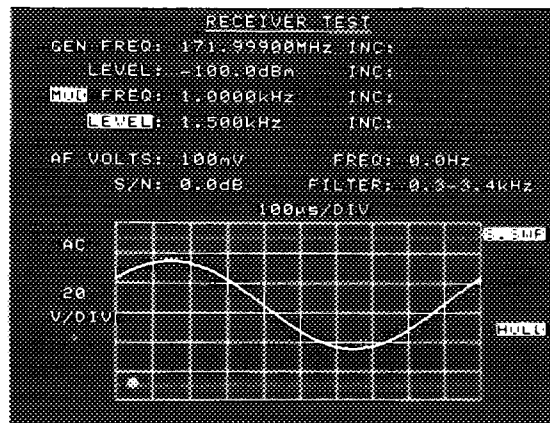



(2) **Set the sweep.**

Press  (brown) for one sweep after a trigger and

to implement the storage facility. The sweep is reset to zero if it has already started.

Press  (brown) for repetitive sweeping on automatic trigger.



(3) **Set the vertical scale.**

Press  and  (brown) to give the required modulation units or volts per division.

(4) **Set the horizontal scale.**

Press  and  (brown) to give the required time per division.

(5) **Adjust the trace position.**

Rotate  and  as required.

SUMMARY OF INDICATORS, CONTROLS AND CONNECTORS

0 1 2 3 4 5 6 7 8 9 . - keys - Enter numeric values.	(25)
6.3 A-T fuse - For DC supply.	*(55)
11-32 V DC SUPPLY connector - To battery pack or external power supply.	(56)
105-120 V 1 A-T 210-240 V 0.5 A-T lever switch - Select supply voltage.	
One of the voltage ranges is covered by the locking plate.	*(54)
AC DC key - Connect voltmeter for AF.	(17)
AC SUPPLY 50-400 Hz 100 VA connector - To mains outlet.	(53)
ACCESSORY IN/OUT connector - To loudspeaker, earphones or filter.	*(36)
AF GEN key - Set AF generator frequency and level.	(10)
AF GEN OUTPUT connector - To transmitter.	(37)
AF INPUT connector - To transmitter.	(38)
AM key - Select amplitude modulation.	(29)
AM indicator LED - On when AM is selected.	(29)
BAND PASS key - Connect 0.3 - 3.4 kHz filter.	(23)
dB key - Set appropriate unit.	(27)
dBm key - Set appropriate unit.	(27)
DELETE key - Cancel preceding digit.	(26)
DE-MOD OUT connector - To other apparatus.	*(49)
Display screen.	(1)
DIST'N ON-OFF key - Select 1 kHz modulation of internal generator.	(16)
DUPLEX TEST key - Select duplex test mode.	(4)
EXT MOD INPUT connector - To external generator.	*(39)
EXT STD 1 MHz connector - To external frequency standard.	*(50)
FM % key - Select frequency modulation.	(28)
FM % indicator LED - On when FM is selected.	(28)
FREQ key - Set generator frequency.	(18)
FREQ Δ key - Increase frequency by preset increment.	(31)
FREQ ▽ key - Decrease frequency by preset increment.	(31)
Fuses - 0.5 A for 210-240 V AC supply, 1.0 A for 105-120 V AC supply.	*(51)
GPIB connector - To remote control apparatus.	*(52)
HELP key - Display help menu.	*(9)
HOLD DISPLAY key - Freeze bar charts or oscilloscope display (except trace) and inhibit other controls.	*(8)
HORIZ ↔ key - Increase time/div.	(43)
HORIZ →← key - Decrease time/div.	(43)
Hz μV key - Set appropriate unit.	(27)

* These are not covered in the text - see the Operating Manual.

SUMMARY OF INDICATORS, CONTROLS AND CONNECTORS

IF OUT connector – To cellular adapter.	(48)
INTENSITY knob – Adjust brightness of trace.	(45)
kHz mV key – Set appropriate unit.	(27)
LEVEL key – Set generator level.	(19)
LEVEL Δ key – Increase level by preset increment.	(31)
LEVEL ∇ key – Decrease level by preset increment.	(31)
LOW PASS key – Connect 0.3 or 15 kHz low pass filter.	(24)
MHz V key – Set appropriate unit.	(27)
ON OFF key – Enable or disable selected generator.	(14)
POSITION \longleftrightarrow knob – Move oscilloscope trace.	(40)
POSITION \updownarrow knob – Move oscilloscope trace.	(41)
RECALL key (followed by 2 digits) – Restore memorized settings.	*(22)
REP SWEEP key – Select repetitive sweeping of oscilloscope trace.	(42)
RF GEN key – Set RF generator frequency and level.	(12)
RF IN/OUT 0.5 or 1 W MAX connector – To transmitter or receiver.	(35)
RF IN/OUT 30 or 75 W MAX connector – To transmitter or receiver.	(34)
RX TEST key – Select receiver test mode.	(3)
RX=TX FREQ key – Tune RF generator to frequency of input.	(11)
SCOPE BAR key – Display oscilloscope or bar charts on screen.	(7)
SELECT \longleftrightarrow key – Select RF IN/OUT connector for measurement.	(33)
SELECT \longleftrightarrow indicator LEDs – RF IN/OUT connector selected for measurement.	(33)
SET MOD key – Select modulation of internal generator.	(13)
SINAD S/N key – Select SINAD or S/N measurement.	(15)
SINGLE SWEEP key – Trigger one sweep of oscilloscope trace.	(42)
STORE key (followed by 2 digits) – Memorize settings (except analogue).	*(21)
SUPPLY ON lever switch – Turn power supply off or on.	(47)
TONES key – Select tones testing.	(5)
TX TEST key – Select transmitter test mode.	(2)
VARIABLE knob – Adjust level.	(32)
VERT \updownarrow key – Increase sensitivity.	(44)
VERT $\downarrow\uparrow$ key – Decrease sensitivity.	(44)
VOLUME knob – Adjust loudness.	(46)
Φ M RAD key – Select phase modulation.	(30)
Φ M RAD indicator LED – Φ M selected.	(30)
Δ INCR – Set increments and decrements.	(20)

* These are not covered in the text – see the Operating Manual.