

RADIO COMMUNICATIONS TEST SET 2955

Part nos. 52955-900A
52955-301W
52955-307C
52955-312B

The 52955-900A version is supplied without a GPIB interface unit.
This unit is then available as an optional accessory. References
in this manual to the GPIB do not, therefore, apply to this version.

© Marconi Instruments Ltd. 1986

*No part of this book may be reproduced or transmitted in any form
or by any means, electronic or mechanical, including photocopying,
or recorded by any information storage or retrieval system, without
permission in writing by Marconi Instruments Ltd.*

Printed in the UK

Manual part no. 46881-622N
Print code : H-4/89

Counters Due to there being two frequency counters, simultaneous AF and RF frequency readings can be displayed. Ranges and resolutions are respectively 10 Hz to 20 kHz at 0.1 Hz and 1.5 to 1000 MHz at 1 or 10 Hz. Either an internal or an external frequency standard may be used.

Signal generator The signal generator can be amplitude, frequency, or phase modulated, internally or externally, the internal modulating signal being obtained from the AF generator. Amplitude modulation is variable up to 70% for carrier frequencies from 0.4 to 400 MHz. FM deviation can be set from 0 to 25 kHz, and Φ M deviation from 0 to 10 radians. Transmitter and receiver measurements can be made from a common N-type connector. The generator BNC socket is automatically protected against reverse power overloads.

Modulation meter Automatic frequency tuning and levelling of the modulation monitor provide accurate measurements of AM, FM and Φ M. Because of the independent tuning, modulation measurements are easily made on duplex systems. The modulation may be observed on an oscilloscope and its symmetry checked from the peak and trough values displayed on a dual bar chart. The demodulated output is available at a rear panel socket. Provision is made for audible monitoring using the built-in loudspeaker or by an external loudspeaker or headphones.

RF power meter The absorption RF power meter will measure up to 75 W continuously or up to 150 W for short periods, over a frequency range of 1.5 to 1000 MHz. Power levels may be observed on an autoranging bar chart in addition to the digital readout. The connection of the throughline power meter (available as an optional accessory) extends the capability of the instrument by enabling measurements of forward power, reverse power and VSWR to be made.

AF generator The AF generator provides a range of frequencies from 20 Hz to 20 kHz plus a fixed 1 kHz output used for distortion measurements and 2 tone test. Its audio output is available at a front panel socket and it also provides the internal AM, FM and Φ M for the signal generator. A combined 600 Ω balanced to unbalanced converter and 20 dB attenuator is available as an optional accessory.

AF voltmeter Operating in the range 20 Hz to 20 kHz, the true RMS audio frequency voltmeter has provisions for measuring AF or AF plus the DC component. Band-pass and low-pass filters may be selected. Level may be observed on an autoranged bar chart.

Distortion meter The AF distortion and signal to noise ratio meter and the associated SINAD meter operate at a frequency of 1 kHz supplied by the AF generator. The bar chart displays are autoranged at 10% and 30% for distortion and signal to noise, 18 dB and 50 dB for SINAD. The CCITT and C-message filters (available as optional accessories) enable psophometrically weighted measurements to be made.

Tones decoder and encoder For testing selective calling tone encoding and decoding equipment, the instrument is capable of receiving and generating four defined tone frequency standards plus a user-defined standard. Sub-audible tones can also be generated. Provision is made to receive a sequence of up to 12 and send a sequence of up to 11 out of 15 allocated tone frequencies. For transmitter testing, each received tone is compared with the standard frequency allocations held in memory and, if within limits, its tone number and % frequency error is displayed. For receiver testing, the tones may be generated in single step, tone burst or continuous cycle.

GPIB interface unit This unit greatly extends the versatility of the instrument, and allows the instrument to form part of an automatic test system. The GPIB additionally enables a display to be configured to the user's own requirements using a comprehensive character set. The GPIB also enables a 24 column ticket printer option to be used.

Calibration and test Routine calibration needs have been kept to a minimum, and calibration factors stored in a non-volatile memory may be accessed with a secure access code from the front panel keys, or via the GPIB, permitting rapid recalibration. A built-in self test facility may be called whenever required which enables faults to be identified to major module level or to groups of components.

SPECIAL FEATURES

Transmitter test

- Setting:** TX key press selects test mode.
- Auto-tuning:** Typically under 3 seconds to acquire and measure:-
RF frequency.
RF power.
Modulation frequency and level.
Modulation distortion.
- Manual tune:** Displays positive and negative frequency offset from carrier. 3 digits and decimal point indicate most significant error.
- Tones decoder:** Decodes CCIR, ZVEI, DZVEI, EEA (or EIA) and user-defined menu. Provides tone number, frequency and % error for up to 12 tones. Tone deviation and duration may be monitored using the digital storage scope in TX test mode.
- RX=TX key:** Presets the RF signal generator frequency for receiver test mode to that shown in TX mode.
- HOLD DISPLAY key:** Freezes screen setting and readings, facilitating high RF power measurements and hard copy printout of TX, RX, duplex or AF test screens.

Receiver test

- Setting:** RX key press selects test mode.
Default settings of RF level, modulation frequency and level reduce function test time.
- Signal generator:** Output level accuracy >2 dB over entire frequency, temperature and attenuator ranges. Level units keyboard selectable either dBm or μ V. Software menu allows user to switch between PD and EMF levels.

SINAD or S/N meter: User-settable default condition allows either SINAD or S/N readings. a dedicated key is provided to toggle the setting.

Tones encoder: Encodes CCIR, ZVEI, DZVEI, EEA (or EIA) and user-defined menu.
User may send up to 11 tones in any standard continuously, tone step or burst. A facility allows for tones to be extended.

Duplex test

Setting: Duplex key press selects test mode.

Modulation meter: Independent modulation meter and RF signal generator allows any frequency offset for duplex radio or cross-band repeater testing.

Tones encoder: Encodes CCIR, ZVEI, DZVEI, EEA (or EIA) and user-defined menu.
User may send up to 11 tones in any standard, continuously, tone step or burst. A facility allows for tones to be extended.

PERFORMANCE DATA

RF signal generator section

Output impedance: 50 Ω nominal.

VSWR: N socket: <1.2:1 to 500 MHz.
<1.35:1 to 1000 MHz.
BNC socket: <2.2:1 to 1000 MHz typical.

Frequency

Range: 0.4 MHz to 1000 MHz.

Resolution: 50 Hz up to 530 MHz.
100 Hz up to 1000 MHz.

Indication: 8 digit display.

Setting: Keyboard entry; step change variation by increment/decrement keys and rotary control.

Accuracy: As internal standard.

Output level

Range (RX mode): -140 dBm to -20 dBm (0.0224 μ V to 22.4 mV PD) from N socket.
-120 dBm to 0 dBm (0.224 μ V to 224 mV PD) from BNC socket.

GENERAL INFORMATION AND DATA

Two-port duplex: -120 dBm to -40 dBm (0.224 μ V to 2.24 mV PD).
 One-port duplex: -140 dBm to -80 dBm (0.0224 μ V to 22.4 μ V PD).
 Resolution: 0.1 dB.
 Indication: 4 digits (dBm/ μ V and PD/EMF).
 Setting: 10 dB and 0.1 dB steps.
 Accuracy: >2 dB for levels above -127 dBm.

Spectral purity

FM on CW: <30 Hz up to 520 MHz, <60 Hz up to 1000 MHz.
 (300 Hz to 3.4 kHz weighted RMS).
 Typically:-
 8 Hz up to 250 MHz.
 15 Hz up to 500 MHz.
 30 Hz up to 1000 MHz.

Harmonics: Harmonics are in band 0.4 to 1000 MHz only.
 <-20 dBc up to 1.5 MHz.
 <-25 dBc 1.5 MHz to 250 MHz.
 <-20 dBc 250 MHz to 1000 MHz.

Sub-harmonics: None up to 530 MHz, <-25 dBc up to 1000 MHz.

Spurious signals: Carrier up to 88 MHz:-
 <-45 dBc below 110 MHz.
 <-35 dBc above 110 MHz.
 Carrier up to 1000 MHz:- <60 dBc.

S/N at 20 kHz offset: <-106 dB/Hz (typical) to 500 MHz.
 <-100 dB/Hz (typical) to 1000 MHz.

RF leakage: <0.5 μ V PD generated in a 50 Ω load by a 2-turn
 25 mm loop as near as 25 mm to the case of the
 instrument with the output set to less than -20 dBm
 and the output terminated in a 50 Ω sealed load.

Protection:

N socket: Reverse power overload indicated by
 visual warning (REMOVE RF INPUT) and audible
 alarm.
 BNC socket: Trip circuit operates at approximately
 1.0 W. Reverse power protection up to 50 W.
 Automatically resets on removal of power input.
 Tripping indicated by visual warning (REMOVE RF
 INPUT) and audible alarm.

Modulation section

Amplitude modulation

CW range:	1.5 to 400 MHz, usable to 400 kHz.
Modulation range:	0 to 70%, usable to 85%.
Frequency range:	50 Hz to 15 kHz.
Resolution:	1%.
Indication:	2 digits.
Setting:	Keyboard entry; step change variation by increment/decrement keys and rotary control.
Accuracy:	$\pm 7\%$ of setting ± 1 digit at 1 kHz. $\pm 10\%$ of setting ± 1 digit from 50 Hz to 5 kHz up to 60% AM. $\pm 15\%$ of setting ± 1 digit from 50 Hz to 15 kHz up to 70% AM.

AM external input

Input impedance:	1 M Ω in parallel with approximately 40 pF.
CW range:	1.5 to 400 MHz.
Modulation depth range:	0 to 70%, usable to 85%.
Frequency range:	50 Hz to 15 kHz.
Sensitivity:	50 Hz to 5 kHz, up to 60% AM:- 1.5 V p-p for 30% AM $\pm 10\% \pm 1\%$ AM. 50 Hz to 15 kHz, up to 70% AM:- 1.5 V p-p for 30% AM $\pm 15\% \pm 1\%$ AM.
AM distortion:	<2% distortion at 1 kHz with 30% AM in a 300 Hz to 3.4 kHz bandwidth.

Frequency modulation

CW range:	0.4 to 1000 MHz.
Deviation range:	0 to 25 kHz.
Modulation frequency range:	50 Hz to 15 kHz.
Resolution:	25 Hz (<6.25 kHz deviation). 100 Hz (<25 kHz deviation).
Indication:	4 digits.
Setting:	Keyboard entry. Step change variation by increment/decrement keys and rotary control.

GENERAL INFORMATION AND DATA

Accuracy: $\pm 7\% \pm 10$ Hz (at 1 kHz).
 $\pm 10\%$ (50 Hz to 15 kHz).

FM external input

Input impedance: 1 M Ω in parallel with approximately 40 pF.
 CW range: 0.4 to 1000 MHz.
 Deviation range: 0 to 30 kHz deviation.
 Modulation frequency range: 1 Hz to 50 kHz.
 Sensitivity: 1 V p-p for 5 kHz deviation $\pm 10\%$ to 1 kHz.
 FM distortion: <1% distortion at 1 kHz with 5 kHz deviation in a 300 Hz to 3.4 kHz bandwidth.

Phase modulation

CW range: 0.4 to 1000 MHz.
 Deviation range: 0 to 10 rad.
 Modulation frequency range: 300 Hz to 3.4 kHz.
 Resolution: 0.02/0.03 rad, up to 6.3 rad.
 Indication: 3 digits.
 Setting: Keyboard entry. Step change variation by increment/decrement keys and rotary control.
 Accuracy: $\pm 8\%$ at 1 kHz. $\pm 11\%$ from 300 Hz to 3.4 kHz.
 Distortion: <2% at 1 kHz with 5 rad measured in a 300 Hz to 3.4 kHz bandwidth.

Φ M external input

Input impedance: 1 M Ω in parallel with approximately 40 pF.
 Deviation range: 0 to 10 rad.
 Frequency range: 300 Hz to 3.4 kHz.
 Sensitivity: 1 V p-p for 5 rad at $\pm 12\%$ at 1 kHz.
 Φ M distortion: <2% at 1 kHz with 5 rads, measured in a 300 Hz to 3.4 kHz bandwidth.

Audio generator and 1 kHz oscillator section

Output impedance:	5 Ω nominal.
Frequency	
Range:	50 Hz to 15 kHz (usable 20 Hz to 20 kHz).
Resolution:	0.1 Hz from 20 Hz to 3.25 kHz. 1 Hz from 3.25 kHz to 20 kHz.
Indication:	5 digits.
Setting:	Keyboard entry. Step change variation by increment/decrement keys and rotary control.
Accuracy:	± 0.01 Hz from 50 Hz to 3.25 kHz. ± 0.1 Hz from 3.25 kHz to 15 kHz.
Signal purity	
Distortion:	<2% up to 15 kHz.
Spurious signals:	<-26 dBc (at 9370 Hz >20 Hz only).
Residual noise:	<0.2 mV RMS in a psophometric bandwidth.
DC offset:	<100 mV DC.
Fixed frequency:	1 kHz.
Accuracy:	As internal standard.
Distortion:	<1%.
Residual noise:	<0.4 mV RMS in a psophometric bandwidth.
DC offset:	<100 mV DC.
Two-tone setting:	Two tones are available. 1 kHz and the AF generator frequency setting, both at the same level.
Output level (EMF)	
Range:	1 mV to 2.55 V up to 5 kHz. 1 mV to 2 V up to 15 kHz.
Accuracy:	$\pm 5\%$ ± 1 count 50 Hz to 15 kHz.
Setting:	1 mV steps from 1 mV to 255 mV. 2.5 mV steps from 255 mV to 635 mV. 10 mV steps from 640 mV to 2.55 V.

GENERAL INFORMATION AND DATA

Maximum input:	N socket: 150 W (TX mode or one-port duplex) or 100 W (two-port duplex) for limited period, typically 2 minutes at 25°C. End of usable working period indicated by visual warning (REMOVE RF INPUT) and audible alarm. BNC socket: 1.2 W. Trip circuit operates at approximately 1.0 W. Overload protection up to 50 W. Tripping indicated by visual warning (REMOVE RF INPUT) and audible alarm.
Frequency range:	1.5 to 1000 MHz.
Resolution:	1% of indicated bar chart range.
Indication:	2 or 3 digits and analogue display.
Setting:	Automatic ranging on scales 0 to 30, 0 to 100, 0 to 300 mW; 0 to 1, 0 to 3, 0 to 10, 0 to 30, 0 to 100, 0 to 300 W.
Acquisition time:	<3 s with 10 Hz resolution.
Accuracy:	$\pm 10\%$ ± 1 digit up to 500 MHz. $\pm 15\%$ ± 1 digit up to 960 MHz. $\pm 20\%$ ± 1 digit up to 1000 MHz. ± 1.25 dB ± 1 digit ≥ 5 mW over the ranges 825 to 845 MHz and 890 to 905 MHz from +15°C to +25°C. (There may be a difference between a TX mode reading and a duplex mode reading. The difference is normal and within the above limits.)

Modulation meter section

Input

Manual tune:	Provides frequency offset indication from carrier. 3 digits and decimal point. Indicates most significant positive or negative error.
Auto tune:	Provides measurement and simultaneous display of RF frequency, RF power, modulation frequency and level.
Sensitivity:	N socket: 5 mW (0.5 V), TX mode selected. 20 mW (1 V), single port duplex. BNC socket: 0.05 mW (50 mV).
Acquisition time:	<3 s with 10 Hz resolution.
AF filters available:	Band-pass - 300 Hz to 3.4 kHz. Low-pass - 300 Hz or 15 kHz.

Amplitude modulation

CW range:	1.5 to 400 MHz.
Modulation depth range:	0 to 90% below 100 MHz. 0 to 80% from 100 to 400 MHz. Usable to 100% when manually tuned. Automatic ranging (bar chart), 0 to 10, 0 to 30, 0 to 100% depth.
Modulation frequency range:	50 Hz to 10 kHz (usable from 10 Hz to 15 kHz).
Resolution:	1% AM.
Indication:	2 digits and \pm peak analogue display.
Accuracy:	$\pm 6\%$ ± 1 digit at 1 kHz. $\pm 8.5\%$ ± 1 digit from 50 Hz to 10 kHz.
Demodulation distortion:	At 30% AM and 1 kHz modulation frequency, 300 Hz to 3.4 kHz bandwidth:- <2% at 21 MHz carrier and above. <5% up to 21 MHz carrier.
Residual AM:	<1%, 300 Hz to 3.4 kHz bandwidth.

Frequency modulation

CW range:	1.5 to 1000 MHz.
Deviation range:	0 to 25 kHz (30 kHz on scope). Automatic ranging (bar chart), 0 to 1, 0 to 3, 0 to 10, 0 to 30 kHz.
Modulation frequency range:	50 Hz to 10 kHz (typically 10 Hz to 15 kHz).
Resolution:	10 Hz up to 2.5 kHz deviation. 1% up to 25 kHz deviation.
Indication:	3 digits and \pm peak analogue display.
Accuracy:	$\pm 6\%$ ± 1 digit at 1 kHz. $\pm 8.5\%$ ± 1 digit over range 50 Hz to 10 kHz.
Demodulation distortion:	<2% distortion at 5 kHz deviation and 1 kHz modulation frequency in a 300 Hz to 3.4 kHz bandwidth.
Residual FM:	For inputs above 20 mW/0.2 mW (N/BNC) in a 300 Hz to 3.4 kHz bandwidth:- <30 Hz RMS (typically 15 Hz) up to 500 MHz. <60 Hz RMS (typically 30 Hz) up to 1,000 MHz.

Phase modulation

CW range:	1.5 to 1000 MHz.
Deviation range:	0 to 10 rad. Automatic ranging (bar chart), 0 to 1, 0 to 3, 0 to 10 rad.
Modulation frequency range:	300 Hz to 3.4 kHz (with respect to 750 μ s de- emphasis).
Resolution:	1% or 0.01 rad.
Indication:	3 digits and \pm peak analogue display.
Accuracy:	$\pm 6\%$ ± 1 digit at 1 kHz. $\pm 8.5\%$ ± 1 digit from 300 Hz to 3.4 kHz.
Demodulation distortion:	<2% at 5 rad and 1 kHz modulation frequency in a 300 Hz to 3.4 kHz bandwidth.

SINAD and S/N meter section

General

Frequency:	1 kHz.
Range:	0 to 18 dB, 0 to 50 dB (SINAD). 0 to 30, 0 to 100 dB (S/N).
Resolution:	0.1 dB.
Indication:	3 digits plus analogue display.
Accuracy:	± 1 dB.
Sensitivity:	50 mV (100 mV for 40 dB SINAD or S/N).

Note ...

For SINAD and S/N measurements, residual FM has to be taken into account.

Distortion meter section

General

Frequency:	1 kHz.
Range:	0 to 10%, 0 to 30% distortion.
Resolution:	0.1% distortion.
Indication:	3 digits and analogue display.

GENERAL INFORMATION AND DATA

Accuracy: $\pm 5\%$ of reading $\pm 0.5\%$ distortion.

Sensitivity: 50 mV (100 mV for 1% distortion).

Note ...

For distortion measurements, residual FM has to be taken into account.

AF voltmeter section

General

Input impedance: 1 M Ω in parallel with approximately 40 pF.

Frequency range: 50 Hz to 20 kHz (or DC), usable 20 Hz to 50 kHz.

Level range: 0 to 100 mV, 0 to 300 mV; 0 to 1, 0 to 3, 0 to 10, 0 to 30, 0 to 100 V.

Resolution: 1 mV or 1% dependent on range.

Indication: 3 digits plus analogue display.

Accuracy: $\pm 3\%$ of reading ± 3 mV ± 1 digit.

Frequency response: Switchable; band-pass 300 Hz to 3.4 kHz, low-pass 300 Hz or 50 kHz.

AF counter section

General

Range: 20 Hz to 20 kHz.

Resolution: 0.1 Hz or 1 Hz.

Indication: 3, 4 or 5 digits.

Accuracy: As internal standard ± 1 digit, ± 0.1 Hz or 0.02% (whichever is greater).

Sensitivity: 50 mV.

Internal frequency standard

OCCO

Normal frequency: 10 MHz.

Temperature coefficient: $< \pm 5$ parts in 10^8 from 5 to 55°C.
 $< \pm 4$ parts in 10^9 from 50 to 70°C.

GENERAL INFORMATION AND DATA

Aging rate: $<\pm 1$ part in 10^7 /month.
 $<\pm 1$ part in 10^6 /year after 1 month's continuous use.

Short-term stability: $<\pm 1$ part in 10^9 , RMS frequency error over a 1 s period.

Retrace error: $<\pm 2$ parts in 10^7 over 24 hours, at constant temperature and after 25 minutes warm-up.

External frequency standard

Range: 1 MHz ± 5 Hz.

Digital storage oscilloscope

General

Single or repetitive sweep. Available in TX, RX and audio test modes, calibrated for AM, FM and Φ M. For viewing demodulated audio (plus external input option).

Frequency range: DC to 50 kHz (from 3 Hz on AC).

Voltage range: 10 mV/div to 20 V/div in 1-2-5 sequence.

Accuracy: $\pm 5\%$.

AM ranges: 20, 10, 5%/div at $\pm 10\%$ accuracy.

FM ranges: $\pm 30, 15, 6, 1.5$ kHz deviation at $\pm 10\%$ accuracy.

Φ M ranges: $\pm 15, 7.5, 3, 1.5$ rad at $\pm 10\%$ accuracy.

Sweep rates: 100 μ s/div to 5 s/div in 1-2-5 sequence accuracy locked to internal standard.

Trigger: Repetitive, or single shot storage.

Other features

Battery option: 16 V, capacity 7 Ah.
Normal usage life, 1.5 h.

GPIB option: All functions except the supply switch and analogue controls are remotely programmable.

Capabilities: Complies with the following subsets as defined in IEEE 488-1978: SH1, AH1, T5, TE0, L4, LE0, SR1, RL1, PP0, DC1, DT1, C0, E1.

Selcall decoder and encoder: Decodes up to 12 tones and encodes up to 11 tones in a CCIR, ZVEI, DZVEI, EEA, EIA or user-defined tone sequence.

Tone decoder facilities:	Display tone number, frequency and percentage error. Screen indicates null tones (using CRT) and annotates out-of-limit frequencies.
Tone encoder facilities:	Send continuous, burst, single step, extend 5th from last tone; null, repeat or frequency shift up to $\pm 9\%$ in 1% steps.
User-defined:	Allows definition for decode or encode of up to 15 tones. Frequency range is 300 Hz to 3.4 kHz (decode) and 20 Hz to 20 kHz (encode) with a duration of 25 ms to 1.2 s (decode) and 10 to 999 ms (encode). Up to a maximum of 12 tones may be received and a maximum of 11 tones may be sent at any one time. Frequencies are retained in non-volatile memory.
Two-tone modulation:	In TX mode, using tones menu, generates 1 kHz fixed plus that from the AF generator. In RX mode, external modulation inputs add to internal modulation.
IF output socket	
Frequency:	110 kHz nominal.
Level:	180 mV minimum.
Impedance:	50 Ω , maximum load 5 k Ω .
Bandwidth:	50 kHz to over 350 kHz.
External standard input socket	
Frequency:	1 MHz.
Level:	100 mV to 3 V RMS.
Impedance:	10 k Ω in parallel with approximately 100 pF.
Demodulation output socket:	
Level:	400 mV p-p for ± 1 kHz deviation, $\pm 10\%$.
Impedance:	10 k Ω nominal.
Bandwidth:	300 Hz to 3.4 kHz band-pass. 300 Hz low-pass or 15 kHz low-pass selected by front panel filter switch.
Accessory socket:	
	Pins 1, 3, 4, 5, 6, 7 designed for future options. Pin 2, +12 V at approximately 100 mA. Pin 7, AF output, 1 W into 8 Ω . Pin 1, pulse output available under GPIB control, approximately 600 ns.

General

Power requirements

Rated supply voltage: 105 to 120 V AC $\pm 10\%$.
210 to 240 V AC $\pm 10\%$.

Supply frequency range: 45 to 440 Hz.

Maximum consumption: 100 VA.

DC supply voltage: 11 to 32 V DC.

DC supply consumption: <60 W.

Radio frequency interference: Conforms with the requirements of EEC Directive 76/889 as to limits of RF interference.

Safety: Complies with IEC 348.

Rated range of use: 0 to 50°C.

Limit range of operation: 0 to 55°C.

Conditions of storage and transport

Temperature: -40°C to +70°C.

Humidity: Up to 90% humidity.

Altitude: Up to 2500 m (pressurized freight at 27 kPa differential, i.e. 3.9 lbf/in²).

Dimensions and weight:

Including handle, feet and cover -

Height: 197 mm (7.75 in)

Width: 389 mm (15.3 in)

Depth: 584 mm (23.0 in)

Weight: 15.5 kg (34 lb).

ACCESSORIES

Supplied

	Part no.
Polythene cover	37490-738D
Stowage cover	41690-411S
Mains input lead	43129-003W
DC input lead assembly	43130-119U
Operating Manual H 52995-900A Vol. 1	46881-622N

Optional

Battery pack (with charger)	54462-023W
Battery pack (without charger)	54462-024D
Lead assembly, BNC connectors, 1.5 m	43126-012S
Lead assembly, N connectors, 1.0 m	54311-095C
Lead assembly, BNC connectors, 1.0 m (double screened for enhanced RFI performance)	43137-052Y
Lead assembly, DIN 7-way connectors, 1.0 m	43130-590R
Lead assembly, DIN 7-way connectors, 3.0 m	43130-591B
Viewing hood assembly	54150-022P
GPIB adapter, IEEE male to IEC female	46883-408K
GPIB lead assembly, IEEE connectors	43129-189U
GPIB lead assembly, IEEE connectors, 1.0 m (double screened for enhanced RFI performance)	46883-962H
Aerial, telescopic, BNC	54421-001N
RF directional power head, 1 to 50 MHz	54421-002L
RF directional power head, 25 to 1000 MHz	54421-003J
Psophometric CCITT filter	54499-042L
Psophometric CMESS filter	54499-043J
20 dB AF attenuator	54431-023A
600 Ω balanced to unbalanced convertor and 20 dB attenuator	54411-052M
IF probe 455 kHz	54451-165L
IF probe 470 kHz	54451-163Y
IF probe 10.7 MHz	54451-164N
Printer	54211-001D
Printer accessory kit (2 paper rolls and ribbon cartridge)	46883-877P
Printer Manual H 54211-001D	46881-645A
Extender board kit	46883-725U
Rack mounting kit	54127-304C
Transit case	46662-192W
Service Manual H 52955-900A Vol. 2	46881-504C
GPIB Manual H 54811-010P	46881-365R
Primary pack	37136-513F

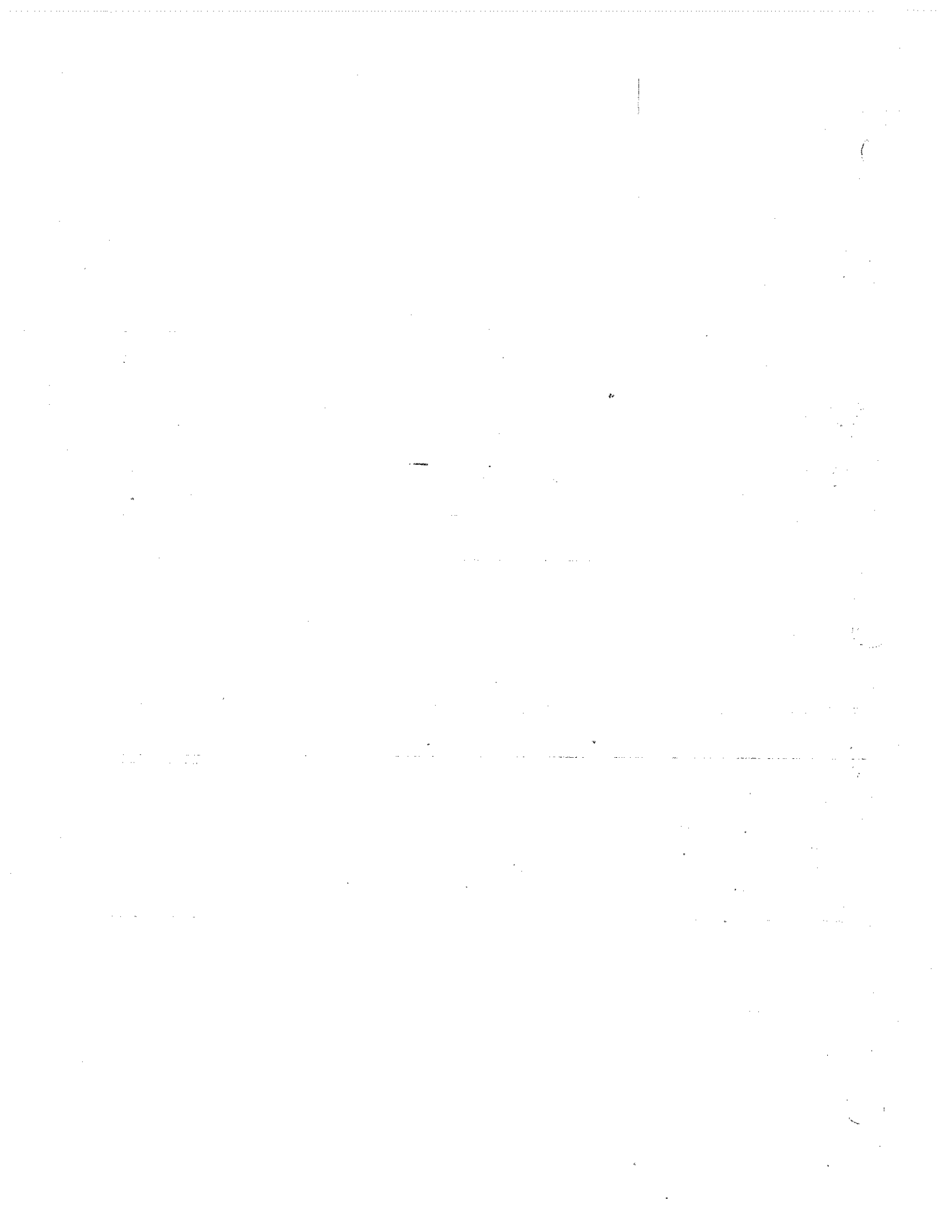

Chapter 2

INSTALLATION

UNPACKING AND REPACKING

Retain the container, packing material and the packing instruction note (if included) in case it is necessary to reship the instrument.

If the instrument is to be returned for servicing, attach a label indicating the service required, type or model number (on rear label), serial number and your return address. Pack the instrument in accordance with the with the more detailed information which is given in the packing instruction note or as follows:-

- (1) Place mains lead in suitable plastic bag and tape it to the instrument rear panel.
- (2) Place the instrument within its plastic cover.
- (3) Ensure that the padded fitting is in place within the inner carton and slide the instrument in, rear panel first, leaving the front panel exposed at the open end.
- (4) Fit the separate front panel protecting cover over the panel and close and seal the inner carton.
- (5) Place one of the moulded plastic cushions in the bottom of the outer carton and insert the inner carton so that it locates in the cushion recess.
- (6) Place the remaining plastic cushion over the other end of the inner carton and close and seal the outer carton.
- (7) Wrap the container in waterproof paper and secure with adhesive tape.
- (8) Mark the package FRAGILE to encourage careful handling.

Note ...

If the original container or materials are not available, use a strong double-wall carton packed with a 7 to 10 cm layer of shock absorbing material around all sides of the instrument to hold it firmly. Protect the front panel controls with a plywood or cardboard load spreader. If the rear panel has guard plates or other projections, a rear load spreader is also advisable.

MOUNTING ARRANGEMENTS

Excessive temperature may affect the instrument's performance; therefore, completely remove the plastic cover, if one is supplied over the case, and avoid standing the instrument on or close to other equipment that is hot.

RACK MOUNTING

The instrument may be mounted in a 19 inch rack using the kit available as an optional accessory. Fitting instructions are as follows:-

- (1) Removal of instrument feet may be carried out without removing the bottom cover. Ease the centre bungs from the feet to expose the retaining screws which are held in captive nuts.
- (2) The front panel storage cover is held in position by two strike plates located at the front of the case side rails. These are attached by self tapping screws and have to be removed.
- (3) To remove the instrument handle, first pull off the brown plastic caps at the ends of the handle side arms. Next remove the exposed central retaining screws from either side.
- (4) Fit the rack brackets securing with an M5 x 16 pan head screw and washer, as supplied, on either side. These screws fit into the position formerly occupied by the handle retaining screws.

Note ...

Ensure adequate outlet for the blown air cooling system.

FITTING THE BATTERY OPTION

The external battery pack, available as an optional accessory, is mounted on top of the instrument as follows:-

- (1) Position the battery pack above the instrument and fit the projecting lugs at the rear of the battery pack (tilting as necessary) into the slots in the instrument's rear feet.
- (2) Secure the pack in place by passing the carrying strap around the body of the instrument then pulling the strap through the friction buckle until tight. Hold the remaining strap length in place using the Velcro fastener.
- (3) To release, press the friction bar to unclamp the strap then ease the lugs out of the rear feet.
- (4) Unclip the connector by pressing on its sides to release it from its storage point, and pull out the attached lead from the case. Reclip the connector to the DC SUPPLY socket on the rear panel.

SAFETY TESTING

Where safety tests on the AC supply input circuit are required, the following procedures can be applied. These comply with BS 4743 and IEC Publication 348. Tests are to be carried out as follows and in the order given, under ambient conditions, to ensure that AC supply input circuit components and wiring (including earthing) are safe.

- (1) Earth lead continuity test from any part of the metal frame to the bared end of the flexible lead for the earth pin of the user's AC supply plug. Preferably a heavy current (about 25A) should be applied for not more than 5 seconds.

Test limit: not greater than 0.5 Ω .

- (2) 500 V DC insulation test from the AC supply circuit to earth.

Test limit: not less than 2 M Ω .

POWER SUPPLY REQUIREMENTS

The instrument may be operated from AC mains or from an external battery pack.

AC power supply

For AC operation, the instrument requires 105 to 120 V or 210 to 240 V, 50 to 400 Hz, 100 VA. The required supply fuses (time lag) are 1A for 105 to 120 V or 500 mA for 210 to 240 V. Before switching on, ensure that the rear panel voltage range switch is in its correct position as revealed by the cut-out in the locking plate, and that the correct value fuses are fitted. To change the mains voltage setting, reverse the locking plate after setting the slide switch to its alternative position.

The AC supply cable is fitted at one end with a female plug which mates with the AC connector at the rear of the instrument. When fitting a supply plug, ensure that the connections are as follows:-

Earth (ground)	-	Green/Yellow
Neutral	-	Blue
Live (phase)	-	Brown

When attaching the mains lead to a non-soldered plug, it is recommended that the tinned ends of the lead are first cut off to avoid the danger of cold flow resulting in intermittent connection.

DC power supply

For DC operation, a 16 V, 7 Ah rechargeable nickel cadmium battery pack is available as an optional accessory. The battery is protected by a time-lag 6.3 A fuse. Remove the battery lead from its stowage and connect to the DC SUPPLY socket on the instrument rear panel. With a fully-charged battery, operating time is in excess of 1 hour.

Alternatively, an external DC supply of between 11 V and 32 V and able to supply approximately 55 W may be used. Connect the battery leads to the rear panel DC SUPPLY socket ensuring that polarities are correct.

AC and DC operation

If both the DC supply and the AC supply are connected, the instrument automatically selects AC power. If the AC power is then removed, the instrument switches to DC with no interruption of operation. In certain circumstances, the external power supply may not be able to take the sudden change in load and its inbuilt protection, e.g. current feedback limiting, may switch off the supply. This can normally be prevented by setting the DC supply to around 20 V. There should be no problems with units able to supply 32 V at approx. 4 mA.

To protect the +12 V power supply to board AC1, an in-line fuse has been fitted between boards AC1 and AB1. The fuse is 1.6 A time-lag. Access to it is gained after removal of the upper half of the case. The fuse is located adjacent to the grey box of the crystal oscillator.

GENERAL PURPOSE INTERFACE BUS

GPIB cable connection

Connection to other equipment which has an IEEE 488 24-way connector can be made with the GPIB lead assembly 43129-189U, available as an optional accessory. An IEEE-to-IEC adapter 46883-408K is also available for connecting to systems using a 25-way bus connector to IEC 625 as shown in Fig. 2-1 below. Where conformity with the radio frequency interference limits specified by VDE (Verband Deutscher Electrotechniker) is required, a double-screened lead assembly 46883-962H is available as an optional accessory.

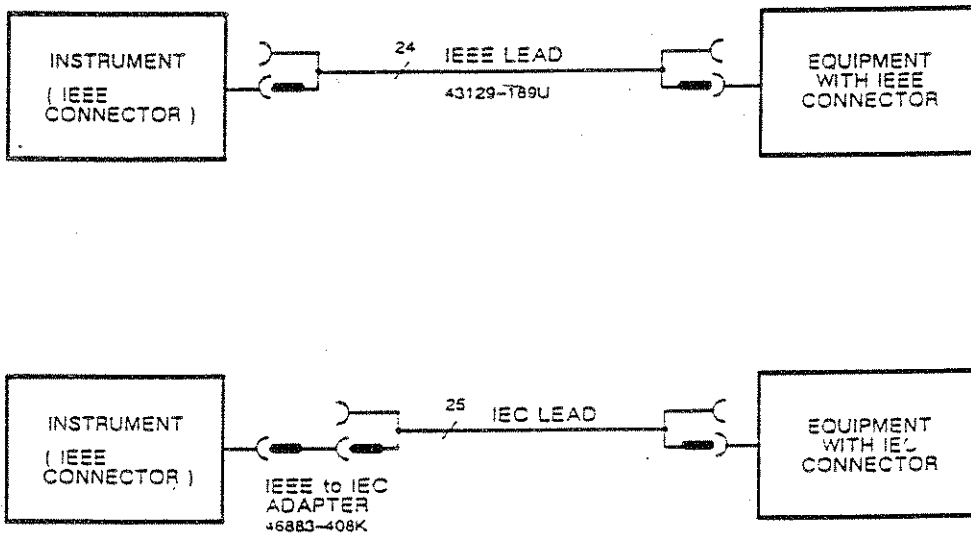

Fig. 2-1 GPIB interconnections

GPIB connector contacts

The contacts on the GPIB cable connector and the device connector is as shown in Fig. 2-2 below.

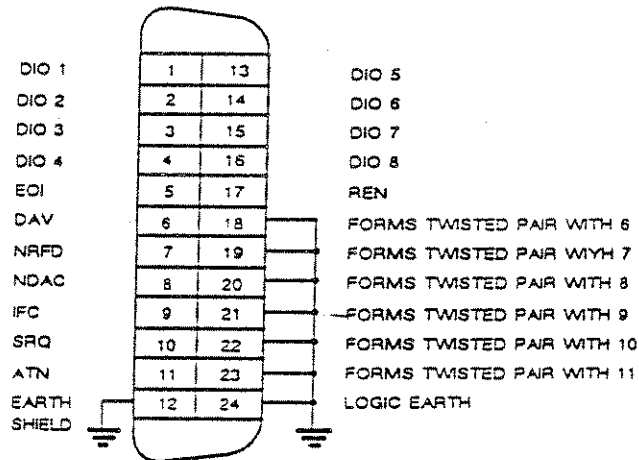

Fig. 2-2 GPIB connector contacts

The cables have special male-female connectors at both ends. This allows several connectors to be stacked one on top of another permitting several cables to be connected to the same source and secured by a lock screw mechanism. Too large a stack however, may form a cantilevered structure which might cause damage and should be avoided. The piggyback arrangement permits star or linear interconnection between the devices forming a system with the restriction that the total cable length for the system is as follows:-

- (1) No greater than 20 m (65 ft).
- (2) No greater than 2 m (6 ft) times the total number of devices (including the controller) connected to the bus.

ACCESSORY SOCKET

The contact numbering of the 7-way DIN socket is shown in Fig. 2-3. Reading clockwise from the earth shield locating spigot, the functions in position order are as follows:-

Position	Pin	Function
1	6	Logic
2	1	Logic
3	4	Forward power
4	2	+12 V DC at approx 100 mA
5	5	Reverse power
6	3	Logic
7	7	Demodulated output

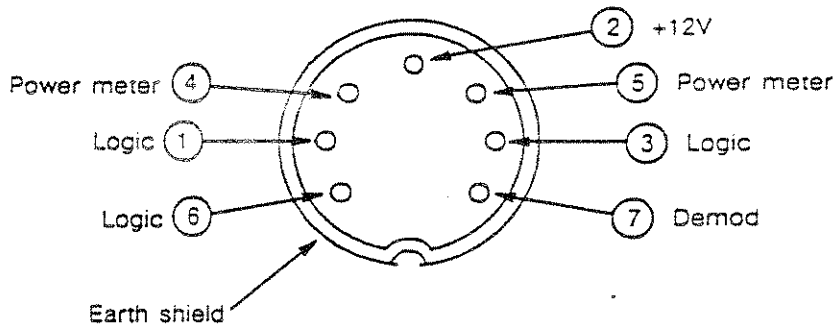

Fig. 2-3 ACCESSORY socket contacts (as viewed from the front)

Selection logic on contacts 6, 1 and 3 enable the instrument to detect and recognise the connection of an external accessory. The appropriate contacts are at TTL levels and are active low (L) as follows:-

Accessory	6	1	3
Nothing connected	H	H	H
Headset (press to talk)	L	L	H
External power: Auto zero	L	H	L
External power: Peak power	L	H	H
External power: RMS power	H	H	L
Psophometric filter: C-MESS	H	L	L
Psophometric filter: CCITT	H	L	H
Spare	L	L	L

A 3.0 m lead assembly 44990-814K is available as an optional accessory.

RF IN/OUT SOCKET

Where conformity with the radio frequency interference limits specified by VDE (Verband Deutscher Elektrotechniker) is required, a double-screened lead assembly 43137-052Y is available as an optional accessory.

Chapter 3

OPERATION

Following power-up conditions and a summary of the front and rear panel controls and connectors, each of the main functions of the instrument is separately detailed in this chapter. The main functions are arranged under the headings of transmitter testing, receiver testing, duplex testing and tones decoding and encoding. Additional operating information is provided upon pressing the HELP key; details are given under 'HELP Key Operation'. To obtain familiarity with the instrument, follow the operating sequences given under 'AF Generator Operation' and 'Signal Generator Operation'; these involve detailed keyboard operations for transmitter and receiver testing respectively.

INITIAL SETTINGS

When switched on, the instrument automatically enters and displays the following set conditions:-

Condition	Setting
Mode	RX
RF generator frequency	300 MHz
RF generator level	-100 dBm
Modulation frequency	1 kHz
Modulation level	FM 1.5 Hz
Filter	0.3-3.4 Hz
Connector	N socket

SELF TEST

At any time, following a period after switch-on to allow the frequency standard to stabilize (typically 5 minutes), the instrument may be self-tested. This facility is entered using the HELP key. Operating details are given under 'HELP Key Operation'.

SELECTING MEASUREMENT MODE

Once the instrument displays its initial settings, you can select the required measurement, usually in three steps as follows:-

- (1) Select mode, e.g. TX, RX, Tones - BLUE key.
- (2) Select function, e.g. AF Gen. Set Modulation- GREEN key.
- (3) Enter data for frequency, level etc - ORANGE and WHITE keys.

Changing from one measurement to another is by simple key operation. For details of the use and operation of the controls for each measurement, see under the relevant heading, e.g. to measure transmitter power, see under 'RF Power Meter'.

- ③ **MODE keys.** These are used to select transmitter testing, receiver testing, duplex testing or tones testing. Also, these are used as soft keys to select programmed functions from menus which are shown alongside on the screen.
- ④ **BAR CHART key.** When this is selected, the bottom half of the screen shows vertical bar charts. Also, this is used as a soft key to select a programmed function from menus which are shown alongside on the screen.
- ⑤ **STORE key.** Stores all front panel settings except those of the analogue controls such as intensity, volume, etc. It is followed by a 2-digit number in the range 01 to 37 to identify the stored setting. Store 00 is automatically allocated to the instrument setting at switch-off or loss of mains or battery power.
- ⑥ **RECALL key.** When followed by a 2-digit number, recalls the front panel setting previously stored using ⑤. When followed by 00, restores the instrument settings to those set at the time of switch-off etc.
- ⑦ **HOLD DISPLAY key.** Freezes the display including the oscilloscope or bar charts (but not the trace). All the front panel keys except HOLD DISPLAY are inoperable. When the key is pressed again, the hold is released. Also, this is used as a soft key to select a programmed function from menus which are shown alongside on the screen.
- ⑧ **HELP key.** Displays the HELP menu. See under 'HELP Key Operation'.
- ⑨ **POSITION controls.** Used to vary the trace position, both horizontally and vertically.
- ⑩ **SINGLE SWEEP key.** Allows only one sweep of the oscilloscope trace to occur after a trigger and implements the storage oscilloscope facility. Resets the sweep if it is part way through.
- ⑪ **REP SWEEP key.** Repetitively sweeps the oscilloscope trace on auto trigger.
- ⑫ **HORIZ key.** Changes the oscilloscope horizontal scale time per division.
- ⑬ **VERT keys.** In TX mode, these change the oscilloscope vertical scale in modulation units per division. In RX mode, they change the oscilloscope vertical scale in volts per division.
- ⑭ **INTENSITY control.** Varies the brightness of the display.
- ⑮ **VOLUME control.** Controls the output of the built-in loudspeaker which is used for monitoring and for alarms.
- ⑯ **SUPPLY switch.** When it is switched to ON, the instrument enters the RX mode.

REAR PANEL

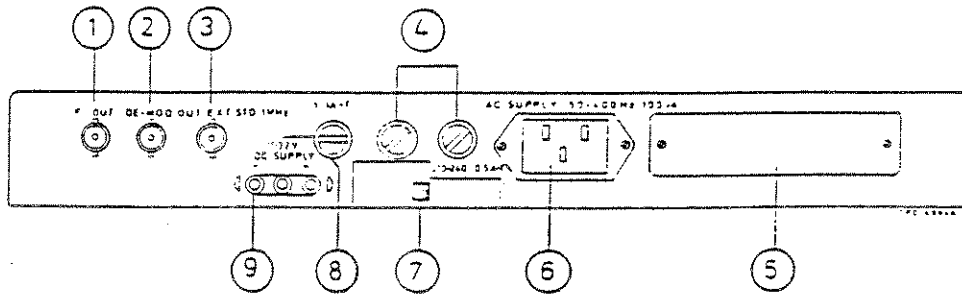

Fig. 3-2 Rear panel

- ① IF OUT SOCKET. BNC socket supplying a 110 ± 10 kHz IF output. Do not load with less than $10 \text{ k}\Omega$.
- ② DE-MOD OUT socket. BNC socket supplying a demodulated output from the modulation meter. Do not load with less than $10 \text{ k}\Omega$.
- ③ EXT STD 1 MHz socket. BNC socket for the connection of an external 1 MHz standard. Connection automatically phase locks the internal standard to the external signal.
- ④ AC supply fuses. Time delay, cartridge type, for fusing ⑥. For details, see Chap. 2, Installation.
- ⑤ GPIB interface unit: For remote operation of the instrument.
- ⑥ AC supply connector. 3-pin AC supply input connector.
- ⑦ Supply voltage selector. To change the range.
- ⑧ DC supply fuse. Time delay, cartridge type, for fusing ⑨. For details, see Chap. 2, Installation.
- ⑨ DC supply socket. 3-pin socket for connection to an optional battery unit or to an external battery. For fitting a battery pack and for operating details, see Chap. 2, Installation.

TRANSMITTER TESTING

AF GENERATOR

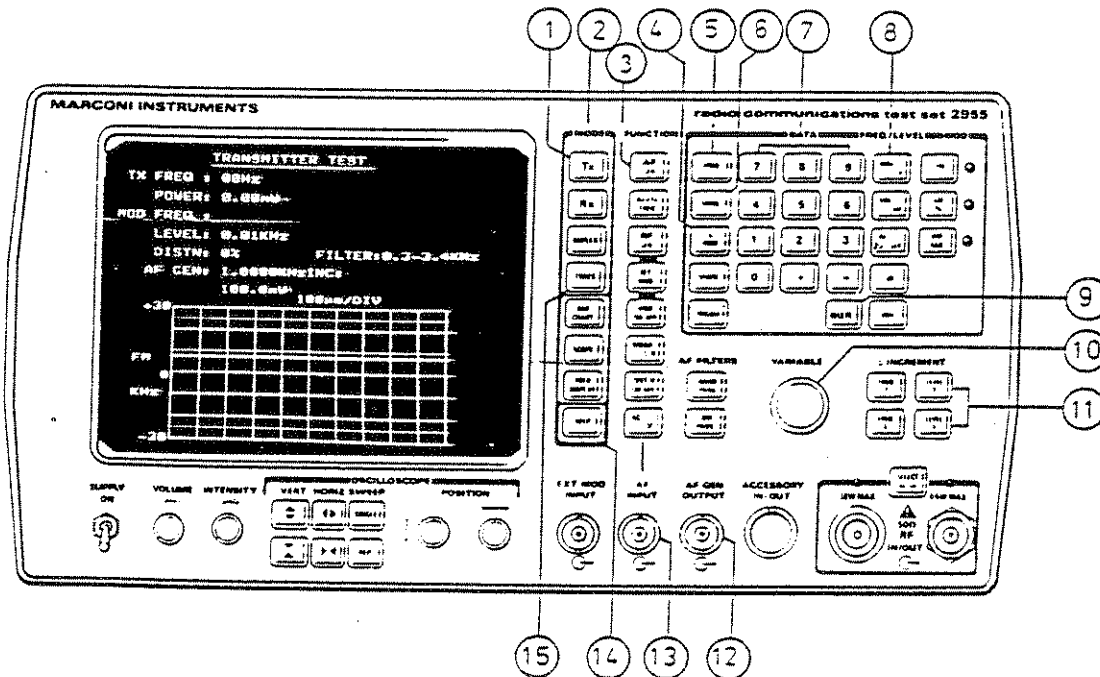

Fig. 3-3 AF generator controls and connectors

- ① TX key. Connects the AF generator to the AF GEN OUTPUT socket ⑫. Writes on the screen information concerning instrument setting.
- ② MODE keys. Used as soft keys to select programmed functions when menus are shown alongside on the screen.
- ③ AF GEN key. Enables the internal AF generator.
- ④ Δ INCR key. Follows a FREQ ⑤ or LEVEL ⑥ entry so that the entered data is recognized as an increment or decrement.
- ⑤ FREQ key. Precedes a keypad ⑦ entry so that the entered data is recognized as a frequency.
- ⑥ LEVEL key. Precedes a keypad ⑦ entry so that the entered data is recognized as a level.
- ⑦ DATA keypad. For data entry using numerals 0 to 9, decimal point and minus sign.
- ⑧ FREQ/LEVEL keys. For defining units of frequency or level. One of these terminates the data entry.

- ⑨ DELETE key. Deletes a preceding digit, decimal point or minus sign entered on ⑦.
- ⑩ VARIABLE control. Analogue control which varies the smallest increment of the function data. Step size is independent of ④ and depends upon range. The level or frequency assignment is shown in reverse field on the screen.
- ⑪ Δ INCREMENT keys. Implement the increment (up arrow) key and decrement (down arrow) key in frequency or level in the step size set using ④.
- ⑫ AF GEN OUTPUT socket. BNC connector supplying an output in the range 20 Hz to 20 kHz for single tone operation plus a fixed 1 kHz for two tone operation. Impedance 5 Ω .
- ⑬ AF INPUT socket. BNC socket for the optional 600 dBm accessory.
- ⑭ HELP key. Used to select the 20 dB attenuator and 600 dBm accessory as described under 'HELP Key Operation'.
- ⑮ TONES key. Used to select two tone operation.

AF generator operation

AF generator operation is detailed under frequency and level.

- (1) Select mode TX ①. TRANSMITTER TEST is written on the screen.
- (2) Select function AF GEN ③. AF GEN is shown in reverse field on the screen.
- (3) Connect the unit under test to the AF GEN OUTPUT socket ⑫.
- (4) To use the optional 600 Ω dBm accessory, e.g. for testing telephone lines, connect this unit between AF GEN OUTPUT ⑫ and the AF INPUT ⑬ sockets. To change the AF voltage readings to dBm (into 600 Ω) use the 'Change Parameters' function. When this is selected, dBm appears in place of voltage. The accessory also provides a 20 dB attenuated output which is also selectable in the 'Change Parameters' function. When this option is selected, a reverse video A is displayed.

Frequency

To tune the AF generator frequency, proceed as follows:-

- (5) Select FREQ ⑤. The frequency to be changed is shown in reverse field. Enter the data on the keypad ⑦, ending with the frequency terminator ⑧, e.g.

for 1.235 kHz, enter the following:-

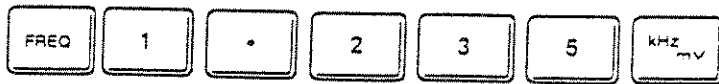

If a mistake is made during data entry, press DELETE (9) and then enter the correct character. When, however, the terminator (8) has been pressed, re-enter the complete data. If incorrect data has been entered, e.g. a frequency outside the range of the instrument, the terminator is ignored and the entry is not accepted. Use DELETE and then re-enter the data.

(6) If required, set the frequency increment/decrement by selecting Δ INCR (4) and entering the data, ending with the frequency terminator, e.g. for 500 Hz steps, enter the following:-



In the example, FREQ may be omitted since it has been previously entered in (5).

(7) Having set the step size, the frequency may be adjusted by repeatedly pressing one of the Δ INCREMENT keys (11), FREQ \uparrow for an increment or FREQ \downarrow for a decrement. For fine frequency control, use the VARIABLE control (10).

Level

To adjust the AF generator level, proceed as follows:-

(8) Select LEVEL (6). The level to be changed is displayed in reverse field. Enter the data on the keypad (7), ending with the level terminator (8), e.g. for 50 mV, enter the following:-

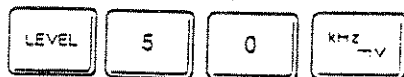

(9) If required, set the level increment/decrement by selecting Δ INCR (4) and entering the data, ending with the level terminator, e.g. for 200 mV steps, enter the following:-

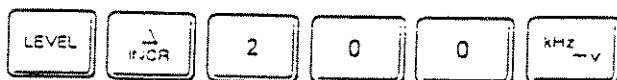

In the example, LEVEL may be omitted since it has been previously entered in (8).

(10) Having set the step size, the level may be adjusted by repeatedly pressing one of the Δ INCREMENT keys (11), LEVEL \uparrow for an increment or LEVEL \downarrow for a decrement. For fine level control, use the VARIABLE control (10).

(11) To use the optional 20 dB attenuator, connect the unit to the AF GEN OUTPUT socket (12). Press the HELP key (14) and then continue by following 'HELP Key Operation'. When the accessory is selected, a reverse field A is displayed and the displayed AF generator level is decreased by a factor of 10 (20 dB).

Two tone operation

To generate two tones, continue as follows:-

(12) Press TONES (15) to display the TONES STANDARD MENU. Press the MODE key (2) which is arrowed by TWO TONES to display the TWO TONES menu.

(13) Press SEND TONE and then return to TRANSMITTER TEST. 2T is shown in reverse video on the display and a 1 kHz tone in addition to the variable frequency output is connected to the AF GEN OUTPUT socket (12). The level is that set previously for the variable frequency.

(14) To return to single tone operation, press TONES (15) and then the key which is arrowed by TWO TONES. Press the key which is arrowed by STOP TONE and then return to TRANSMITTER TEST.

RF POWER METER

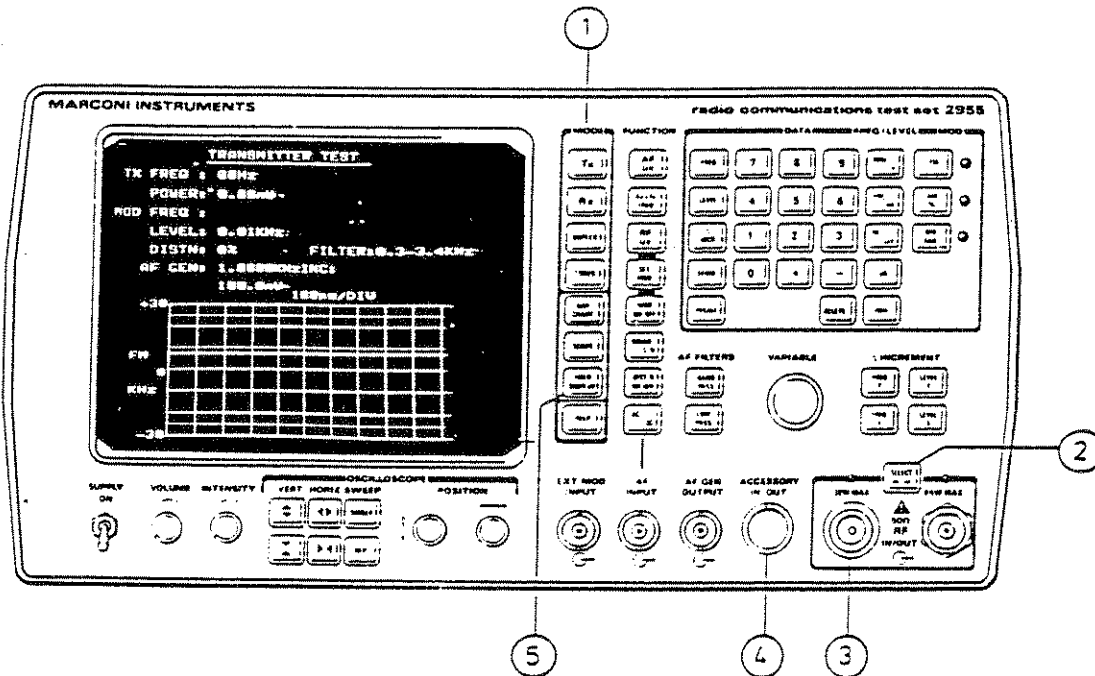

Fig. 3-4 RF power meter controls and connectors

- ① TX key. Connects the RF power meter and the RF counter to the RF IN/OUT N socket ③. Writes on the screen information concerning the instrument settings.
- ② SELECT key and LEDs. For selecting RF IN/OUT N socket ③. LED lights above the socket when it is correctly selected.
- ③ RF IN/OUT N socket. For the transmitter output. A temperature sensor detects excessive power being applied. Impedance 50 Ω .
- ④ ACCESSORY socket. DIN 7-pin connector for the external RF directional power head option.
- ⑤ HOLD DISPLAY key. The display, including the oscilloscope or bar charts (but not the trace), is frozen. All keys, except HOLD DISPLAY, are inoperable. When the key is pressed again, the hold is released.

Power meter operation

- (1) Select mode TX ①. This connects the RF power meter and the RF counter to the RF IN/OUT N socket ③. Writes TRANSMITTER TEST on the screen.
- (2) Press SELECT ②, if necessary, to light the LED above the RF IN/OUT N socket ③.

- (3) Connect the unit under test to the RF IN/OUT N socket ③ .
- (4) The instrument automatically tunes to the transmitter's RF frequency.
- (5) If the applied power exceeds that allowable, the display flashes 'REMOVE RF INPUT' followed shortly by an audible warning.
- (6) The applied RF power and carrier frequency are displayed on the screen.
- (7) If required, the transmitter may be tuned for minimum or zero indicated offset using the 2955 - see 'Transmitter frequency adjustment' under 'Applications'.
- (8) If required, connect the RF directional power head to the ACCESSORY socket ④ for automatic measurement and display for forward and reverse power and of VSWR. (See the Power Head Manual for details.)

MODULATION METER

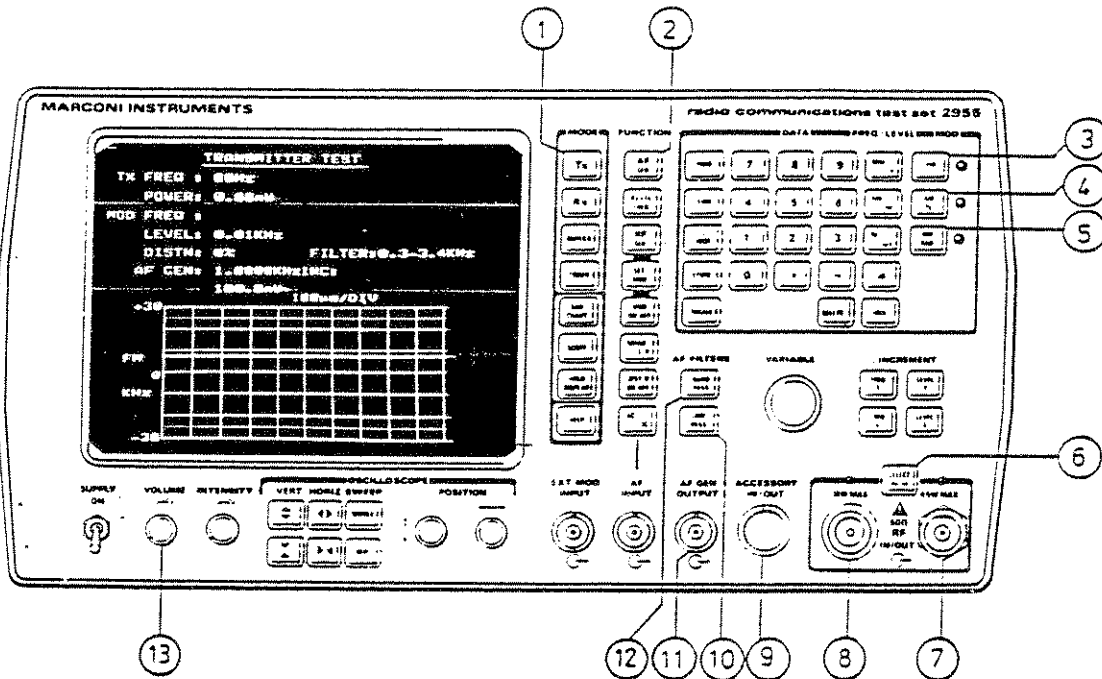

Fig. 3-5 Modulation meter controls and connectors

- ① TX key. Connects the modulation meter to RF IN/OUT socket ⑦ or ⑧ and connects the AF generator to the AF GEN OUTPUT socket ⑪. Writes on the screen information concerning instrument settings.
- ② AF GEN key. Enables the internal AF generator to supply a modulating signal to socket ⑪.
- ③ MOD FM key and LED. When the key is pressed, the LED lights to show that the FM route to the demodulator has been selected.
- ④ MOD AM key and LED. When the key is pressed, the LED lights to show that the AM route to the demodulator has been selected.
- ⑤ MOD Φ M key and LED. When the key is pressed, the LED lights to show that the Φ M route (FM route with de-emphasis) has been selected to the demodulator.
- ⑥ SELECT key and LEDs. For selecting RF IN/OUT BNC or N socket ⑦ or ⑧. LED lights above the socket selected.
- ⑦ RF IN/OUT BNC socket. For the telescopic aerial option. Automatically protected against excessive power.
- ⑧ RF IN/OUT N socket. For high level inputs. A temperature sensor detects excessive power being applied. Impedance 50 Ω .

- ⑨ ACCESSORY socket. DIN 7-pin connector for external loudspeaker or earphones. Connection does not disable the internal loudspeaker. Control of volume is by ⑬.
- ⑩ LOW PASS key. Selects a 300 Hz or a 15 kHz low-pass filter.
- ⑪ AF GEN OUTPUT socket. BNC connector supplying a modulating output in the range 20 Hz to 20 kHz. Impedance 5 Ω .
- ⑫ BAND PASS key. Selects a 0.3 to 3.4 kHz band-pass filter.
- ⑬ VOLUME control. Controls the volume of the internal loudspeaker and of a loudspeaker or earphones connected to ⑨.

Modulation meter operation

To measure AM depth or FM and DM deviation, proceed as follows:-

- (1) Select TX ①. TRANSMITTER TEST is written on the screen.
- (2) Connect the transmitter output to the RF IN/OUT N socket ⑧. Alternatively, connect the telescopic aerial option to the RF IN/OUT BNC socket ⑦.
- (3) The instrument automatically tunes to the transmitter's frequency. If required, the transmitter may be tuned for minimum or zero indicated offset using the 2955 - see 'Transmitter frequency adjustment' under 'Applications'.
- (4) Press SELECT ⑥ until the LED lights above the RF IN/OUT N connector ⑧ or the BNC connector ⑦.
- (5) Select modulation type FM ③, AM ④, or Φ M ⑤. If greater than 50% AM is applied, there is a possibility that false readings may occur. Use keyboard tuning of the modulation meter as for 'Transmitter frequency adjustment'.
- (6) Press BAND PASS ⑫ to select the 0.3 to 3.4 kHz BP filter or press LOW PASS ⑩ once or twice as necessary to select a 300 Hz or 15 kHz LP filter.
- (7) If required, modulate the transmitter's carrier by connecting the AF GEN OUTPUT socket ⑪ to the microphone input of the transmitter. Set the frequency and level as under 'AF generator operation'.
- (8) Read the displayed % depth for AM or the deviation and symmetry for FM and Φ M.
- (9) Adjust VOLUME control ⑬ to monitor the demodulated signal using the internal loudspeaker, an external loudspeaker or earphones using the ACCESSORY socket ⑨.
- (10) The demodulated output is available at the DE-MOD OUT socket on the rear panel.

DISTORTION METER (TX)

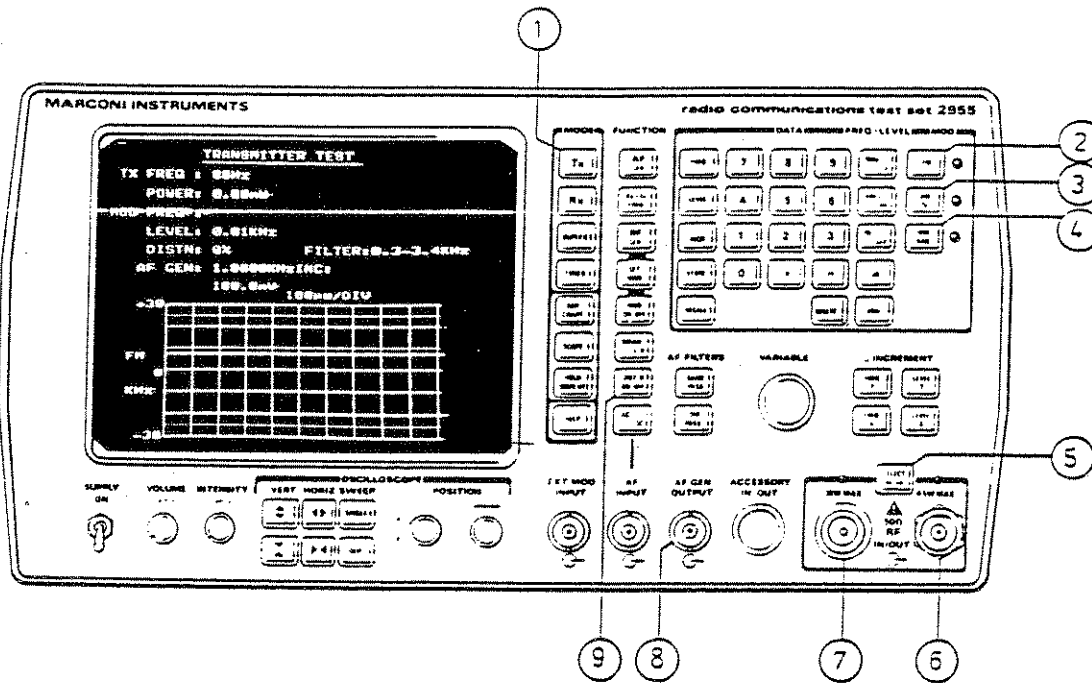

Fig. 3-6 Distortion meter (TX) controls and connectors

- ① TX key. Connects the distortion meter to the RF IN/OUT BNC socket ⑥ or N socket ⑦ and connects the AF generator to the AF GEN OUTPUT socket ⑧. Writes on the screen information concerning instrument settings.
- ② MOD FM key and LED. When the key is pressed, the LED lights to show that the FM route to the demodulator has been selected.
- ③ MOD AM key and LED. When the key is pressed, the LED lights to show that the AM route to the demodulator has been selected.
- ④ MOD DM key and LED. When the key is pressed, the LED lights to show that the Φ M route (FM route with the de-emphasis) has been selected to the demodulator.
- ⑤ SELECT key and LEDs. For selecting RF IN/OUT socket ⑥ or ⑦. LED lights above the socket selected.
- ⑥ RF IN/OUT BNC socket. For the transmitter input. Automatically protected against excessive power. Impedance 50 Ω .
- ⑦ RF IN/OUT N socket. For the transmitter input. A temperature sensor detects excessive power being applied.
- ⑧ AF GEN OUTPUT socket. Output used to modulate the transmitter under test with a 1 kHz tone. Impedance 5 Ω .

- ⑨ DIST'N ON-OFF key. Causes the AF generator to generate a 1 kHz tone to socket
- ⑧. The display indicates when distortion is selected.

Distortion meter operation

To make a transmitter distortion measurement, proceed as follows:-

- (1) Select TX ①. TRANSMITTER TEST is written on the screen.
- (2) Connect the transmitter output to the RF IN/OUT BNC connector ⑥ for a low level RF output or to the RF IN/OUT N connector ⑦ for a high level RF output.
- (3) Press SELECT ⑤ and ensure that the LED lights above the socket selected.
- (4) The instrument automatically tunes to the transmitter's frequency. If required, the transmitter may be tuned for minimum or zero indicated offset using the 2955 - see 'Transmitter frequency adjustment'.
- (5) Connect the AF GEN OUTPUT socket ⑧ to the transmitter's microphone input to provide amplitude, frequency or phase modulation.
- (6) Press DIST'N ON-OFF ⑥ until DISTN is displayed. This causes a 1 kHz tone to be generated to socket ⑤ to modulate the transmitter.
- (7) Select modulation FM ②, AM ③, or Φ M ④.
- (8) Read the % distortion from the display.

APPLICATIONS

Transmitter frequency adjustment

If the transmitter setting, e.g. 400 MHz, does not agree with the measured frequency, e.g. 400.000100 MHz, the offset may be corrected as follows:-

- (1) With TX mode selected, press FREQ and then enter the transmitter setting, e.g. 400 MHz.
- (2) The offset is displayed as a positive or negative value, e.g. +100 Hz.
- (3) Adjust the transmitter's internal frequency while observing the offset. Tune until negative values are seen and then readjust positively for zero offset.
- (4) AUTO TUNE is written on the screen alongside the TX key. Press this key. The 2955 automatically tunes to and displays the transmitter's corrected frequency.

RECEIVER TESTING

RF GENERATOR

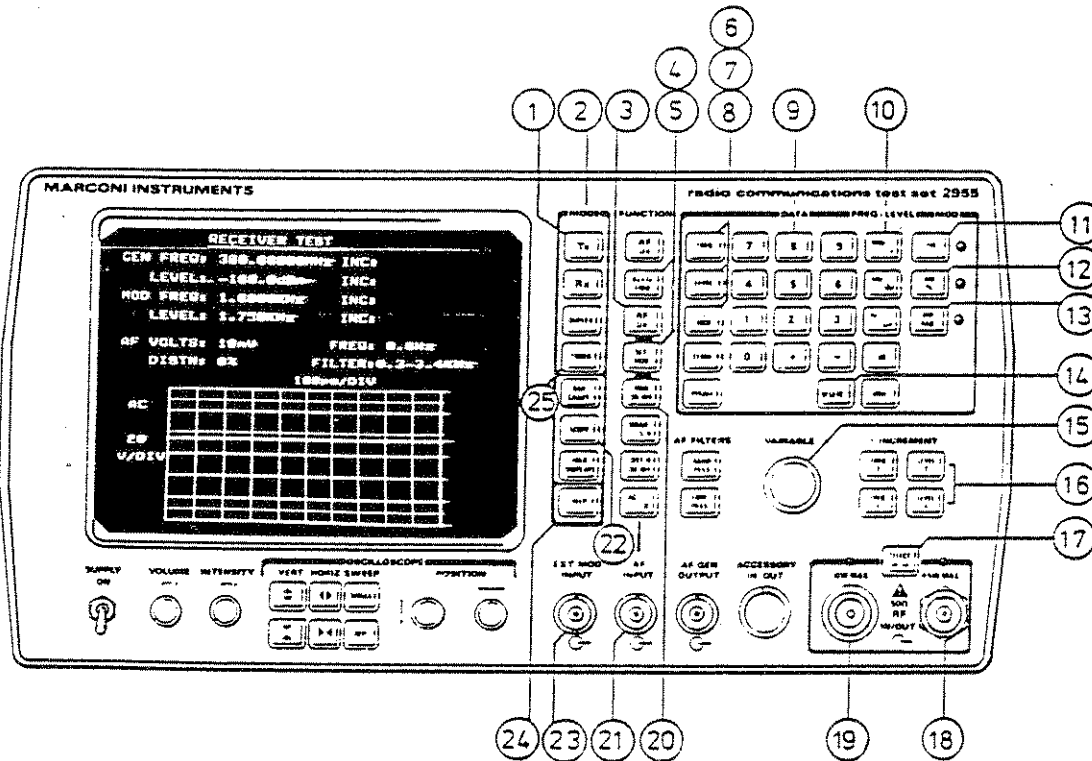

Fig. 3-7 RF generator controls and connectors

- ① RX key. Connects the RF generator to the RF IN/OUT BNC and N sockets ⑱ and ⑲. Writes on the screen information concerning the instrument settings.
- ② MODE keys. Used as soft keys to select programmed functions when menus are shown alongside on the screen.
- ③ RF GEN key. Enables the internal signal generator.
- ④ RX=TX FREQ key. Used only when in TX mode with the transmitter keyed up. Tunes the signal generator to the frequency of a transmitter connected to ⑱ or ⑲. The receiver section of a transceiver can be tested without having to enter the frequency.
- ⑤ SET MOD key. Enables the internal signal generator modulation system. Followed by a FREQ ⑥ or LEVEL ⑦ entry to set the modulation value.
- ⑥ FREQ key. Precedes a keypad ⑨ entry so that the entered data is recognized as a frequency.
- ⑦ LEVEL key. Precedes a keypad ⑨ entry so that the entered data is recognized as a level. As supplied, each 2955 is programmed either for European or for North American standards. European practice is to show the output level as PD or EMF.

- ⑧ Δ INCR key. Precedes a keypad ⑨ entry so that the entered data is recognized as an increment/decrement.
- ⑨ DATA keypad. For data entry using numerals 0 to 9, decimal point and minus sign.
- ⑩ FREQ/LEVEL keys. For defining units of frequency or level. Unless entering modulation, terminates the data entry.
- ⑪ MOD FM key and LED. Enables the preceding frequency entry to be recognized as a frequency modulation deviation. Activates the frequency modulator for the signal generator. LED lights to show that FM has been selected. Modulation is switched on and off by ⑳.
- ⑫ MOD AM % key and LED. Enables the preceding keypad ⑨ entry to be recognized as an amplitude modulation percentage. Activates the amplitude modulator for the signal generator. LED lights to show that AM has been selected. Modulation is switched on and off by ⑳.
- ⑬ MOD Φ M RAD key and LED. Enables the preceding keypad ⑨ entry to be recognized as a phase modulation deviation. Activates the frequency modulator with pre-emphasis for the signal generator. LED lights to show that Φ M has been selected. Modulation is switched on and off by ⑳.
- ⑭ DELETE key. Deletes a preceding digit, decimal point or minus sign entered on the keypad ⑨.
- ⑮ VARIABLE control. Analogue control which varies the smallest increment of the function data. Step size is independent of ⑧ and depends upon range. The level for frequency assignment is shown in reverse field on the screen.
- ⑯ Δ INCREMENT keys. Implement the increment (up arrow) key or decrement (down arrow) key in frequency or level in the step size set using ⑧.
- ⑰ SELECT key and LEDs. For selecting RF IN/OUT socket ⑱ or ⑲. LED lights above the socket selected.
- ⑱ RF IN/OUT BNC socket. For RF signal generator output levels up to 225 mV. Impedance 50 Ω . Automatically protected against excessive reverse power during duplex operation.
- ⑲ RF IN/OUT N socket. For RF signal generator output levels up to 22.5 mV. Impedance 50 Ω .
- ⑳ MOD ON-OFF key. Switches the signal generator modulation, both internal and external, on and off. Does not affect LEDs ⑪ to ⑬.
- ㉑ AF INPUT socket. BNC socket used to set up an external modulation level.

- ⑳ SCOPE key. When selected, the single trace oscilloscope display enables an external modulation level to be correctly set.
- ㉑ EXT MOD INPUT socket. BNC connector for the application of an external modulating signal. When added to the internal modulation, provides two or three tone modulation. The maximum level is then displayed.
- ㉒ HELP key. Enables access to the CHANGE PARAMETERS menu for selection of EMF (unloaded) or PD (loaded).
- ㉓ TONES key. Used to select two tone modulation using the internal AF generator.

RF generator operation

Signal generator operation is detailed under frequency, level and modulation. Proceed as follows:-

- (1) Select RX ①. RECEIVER TEST is written on the screen.
- (2) Select function RF GEN ③.
- (3) Connect the unit under test to RF IN/OUT BNC socket ⑱ or to N socket ⑲. Press SELECT ⑰ until the LED lights above the socket selected for the RF output.

Frequency

To tune the signal generator frequency, proceed as follows:-

- (4) Select FREQ ⑥. The frequency to be changed is shown in reverse field. Enter the data on the keypad ⑨, ending with the frequency terminator ⑩, e.g. for 123.5 MHz, enter the following:-



If a mistake is made during data entry, press DELETE ⑭ and then enter the correct character. When, however, the terminator ⑩ has been pressed, re-enter the complete data. If incorrect data has been entered, e.g. a frequency outside the range of the instrument, the terminator is ignored and the entry is not accepted. Use DELETE and then re-enter the data.

- (5) If required, set the frequency increment/decrement by selecting Δ INCR ⑧ and enter the data, ending with the frequency terminator, e.g. for 500 kHz steps, enter the following:-



In the example, FREQ may be omitted since it has been previously entered in (4).

(6) Having set the step size, the frequency may be adjusted by repeatedly pressing one of the Δ INCREMENT keys (16), $\text{FREQ} \uparrow$ for an increment or $\text{FREQ} \downarrow$ for a decrement. For fine frequency control, use the VARIABLE control (15).

Level

To adjust the signal generator level, proceed as follows:-

(7) Select LEVEL (7). The level to be changed is displayed in reverse field. Enter the data on the keypad (9), ending with the level terminator (10), e.g. for -34 dBm, enter the following:-



(8) If required, set the level increment/decrement by selecting Δ INCR (8) and enter the data, ending with the level terminator, e.g. for 0.5 dB steps, enter the following:-



In the example, LEVEL may be omitted since it has been previously entered in (7).

(9) Having set the step size, the level may be adjusted by repeatedly pressing one of the Δ INCREMENT keys (16), $\text{FREQ} \uparrow$ for an increment or $\text{FREQ} \downarrow$ for a decrement. For fine level control, use the VARIABLE control (15).

To change between PD (loaded) and EMF (unloaded), press the HELP key (24) and then continue by following 'HELP Key Operation'.

Modulation

To set the signal generator modulation, proceed as follows:-

Modulation frequency

(10) Select SET MOD (5)

(11) Select FREQ (6) and then enter the data, ending with the frequency terminator (10), e.g. for 1.5 kHz AM, FM or Φ M, enter the following:-



(12) If required, the modulation frequency may be adjusted as for (5) and (6).

Amplitude modulation

(13) For amplitude modulation, select LEVEL (7) and then enter the modulation depth in %. Terminate with key (12) and check that the associated lamp lights, e.g. for 60% AM, enter the following:-



(14) If required, set the modulation value increment/decrement by selecting Δ INCR (8) and entering the step size, e.g. for a 2% step, enter the following:-



In the example, LEVEL may be omitted since it has been previously entered in (13).

(15) Adjust the modulation value as for (9).

Phase modulation

(16) For phase modulation, select LEVEL (7) and then enter the deviation in radians. Terminate with key (12) and check that the associated lamp lights, e.g. for 6 radians, enter the following:-



(17) If required, set the modulation value increment/decrement by selecting Δ INCR (8) and entering the step size, e.g. for a 2 radians step, enter the following:-



In the example, LEVEL may be omitted since it had been entered in (16).

(18) Adjust the modulation value as for (9).

Frequency modulation

(19) For frequency modulation, select LEVEL (7) and then enter the deviation, ending with the frequency terminator (10). Press FM (11) and check that the associated lamp lights, e.g. for 5 kHz FM deviation, enter the following:-



(20) If required, set the modulation value increment/decrement by selecting Δ INCR (8) and entering the step size. e.g. for a 4 kHz step, enter the following:-



In the example, both LEVEL and FM may be omitted since they have been previously entered in (19).

(21) Adjust the modulation value as for (9).

Modulation on/off

(22) Switch the modulation (both internal and external, if applied) on or off as required using the MOD ON-OFF key (20). The off condition is shown in reverse field on the display.

External modulation (single or two tone)

(23) To set the external modulation, connect the signal to the AF INPUT socket (21). Select SCOPE (22) and observe the signal. Set the frequency and adjust the level in accordance with the data in the 'Modulation Section' of 'Performance Data', Chap. 1.

(24) Connect the modulating signal to EXT MOD INPUT (23). For two tone modulation, the external modulation then adds to the internal modulation. To switch off the internal modulation while retaining external modulation, enter 0 kHz for FM, 0% for AM or 0 radians for Φ M.

Internal two tone modulation

(25) Press TONES (25) to display the TONES STANDARD MENU. Press the MODE key (2) indicated by the SUB-AUDIBLE arrow. RX SUB-AUDIBLE TONE is displayed together with the current sub-audible tone frequency, level and modulation. As shown on the screen, the signal generator is now modulated by a fixed 1 kHz tone.

(26) Press the key arrowed by FREQUENCY and set the second, variable frequency using the keypad (9), ending with the frequency terminator (10).

(27) Press the key arrowed by MOD LEVEL and set the level using the keypad (9), ending with the level terminator (10).

(28) Press the key arrowed by SEND TONE to generate the sub-audible tone the return to RECEIVER TEST. SAT is displayed in reverse field against the 1 kHz modulation frequency.

(29) To return to single tone modulation, press TONES (25) and then the key arrowed by SUB-AUDIBLE. Press the key arrowed by STOP TONE and then return to RECEIVER TEST.

AF VOLTMETER

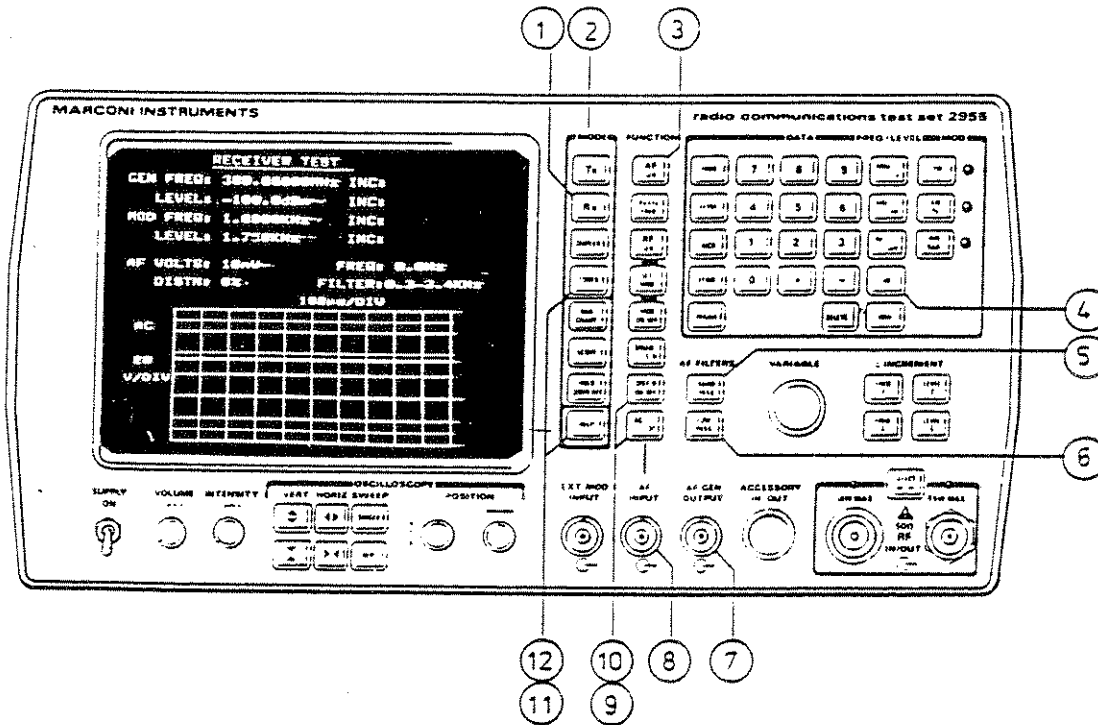

Fig. 3-8 AF voltmeter controls and connectors

- ① RX key. Connects the AF voltmeter to the AF input socket (8). Writes on the screen information concerning instrument settings.
- ② MODE keys. Used as soft keys to select programmed functions when menus are shown alongside on the screen.
- ③ AF GEN key. Enables the AF generator.
- ④ dB key. Selects dBV or dBr.
- ⑤ BAND PASS key. Selects a 300 Hz to 3.4 kHz band-pass filter.
- ⑥ LOW PASS key. Selects a 300 Hz or a 50 kHz low-pass filter.
- ⑦ AF GEN OUTPUT socket. BNC socket for the optional 600 Ω dBm and 20 dB attenuator accessory - see 'Accessories', Chap. 1.
- ⑧ AF INPUT socket. BNC socket for the AF or modulated DC input.
- ⑨ AC DC key. Changes the state of the input from the socket (8) between an AF or a modulated DC voltage. The display indicates when AC or DC is selected.
- ⑩ DIST'N ON-OFF key. Set to OFF for dBV or dBr measurement.

- ⑪ HELP key. Used to select the 20 dB attenuator and 600 Ω dBm accessory as described under 'HELP Key Operation'.
- ⑫ TONES key. Used to select two tone operation during AUDIO TEST.

AF voltmeter operation

- (1) Connect the unit under test to the AF INPUT socket ⑧.
- (2) Select mode RX ①. RECEIVER TEST is written on the screen.
- (3) Press BAND PASS ⑤ to select the 300 Hz to 3.4 kHz BP filter or press LOW PASS ⑥ once or twice as necessary to select a 300 Hz or 50 kHz LP filter.
- (4) To read AF volts, press the AC DC key ⑨ until AC is displayed.
- (5) To read DC plus AF volts, press the AC DC key ⑨ until DC is displayed. The 50 kHz filter is automatically selected. Note that the DC is shown with no sign but may be positive or negative.
- (6) To select dBV or dBr (dB relative to the entered level), set ⑩ to DIST'N OFF.
- (7) If required, change between dBV and dBr by pressing the dB key ④.
- (8) To use the optional 600 Ω dBm accessory, e.g. for testing telephone lines, connect this unit between the AF GEN OUTPUT ⑦ and the AF INPUT ⑧ sockets. Press the HELP key ⑪ and then continue by following 'HELP Key Operation'. When the accessory is selected, dBV or dBr changes to dBm.

Audio test

During AUDIO TEST operation, AF generator operation - normally a transmitter test function - is enabled in addition to the AF voltmeter. This permits the generator to be tuned while the voltmeter readings are noted. This may be used to plot the characteristics of a filter or an amplifier which is connected between the AF GEN OUTPUT and the AF INPUT sockets. To operate in AUDIO TEST, proceed as follows:-

- (9) Press AF GEN ③. AUDIO TEST is written on the screen and the AF generator is enabled.
- (10) Select the required filter as in (3).
- (11) Select AC or DC as in (4) or (5).
- (12) Select dBV or dBr as in (6) and (7).

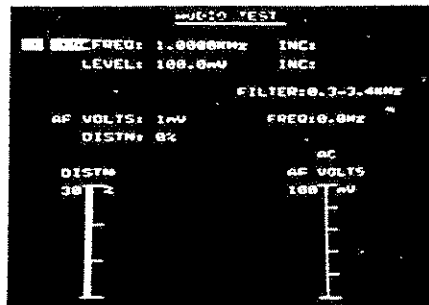

(13) To use the 600 Ω dBm accessory, see (8).

(14) To use the optional 20 dB attenuator, connect the unit to the AF GEN OUTPUT socket (7). Press the HELP key (11) and then continue by following 'HELP Key Operation'. When the accessory is selected, a reverse field A is displayed and the displayed AF generator level is decreased by a factor of 10 (20 dB).

Two tone operation may be selected during AUDIO TEST. A fixed 1 kHz tone is fed out with that from the AF generator to the AF GEN OUTPUT socket. Continue as follows:-

(15) To select two tone operation, press TONES (12). Generate two tones by pressing the key which is arrowed by SEND TONE. Return to AUDIO TEST. 2T is displayed in reverse field.

(16) To return to single tone operation, press TONES (12) and then switch off the 1 kHz output by pressing the key which is arrowed by STOP TONE. Return to AUDIO TEST.

(17) To return to RECEIVER TEST, press RX (1).

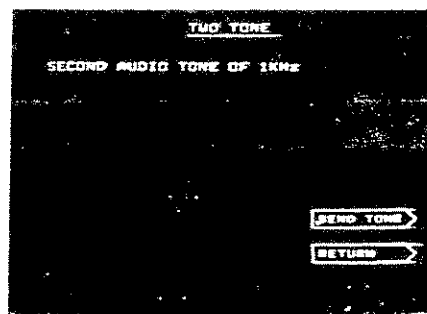

DISTORTION METER (RX)

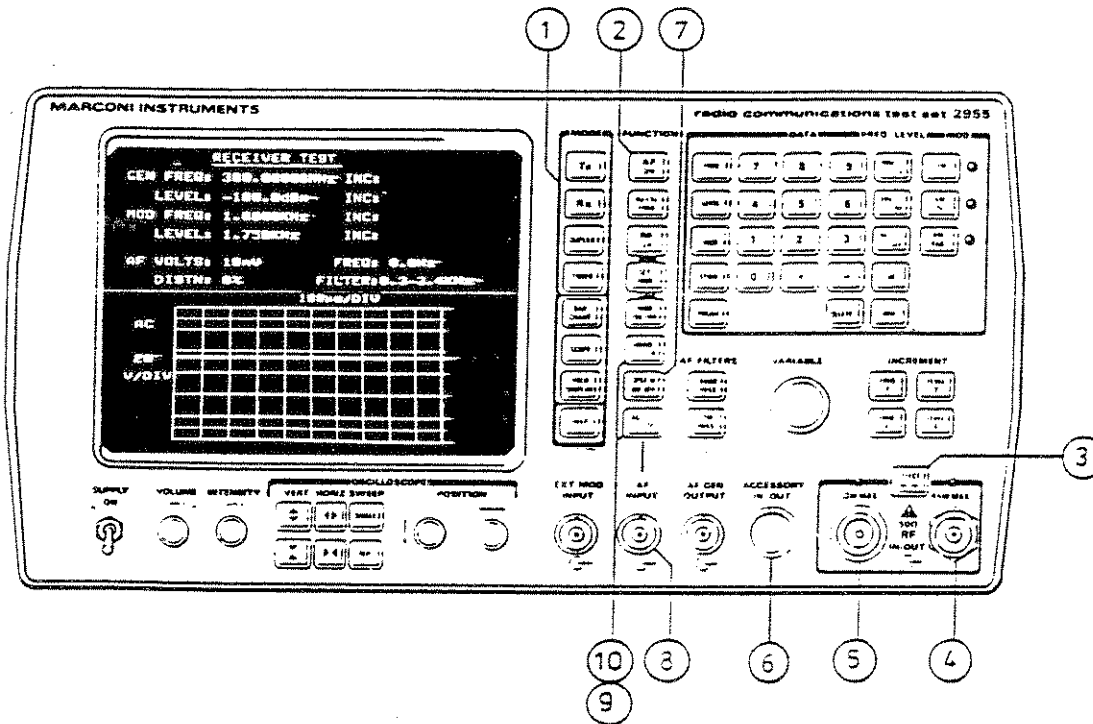

Fig. 3-9 Distortion meter (RX) controls and connectors

- ① RX key. Connects the signal generator output to RF IN/OUT BNC and N sockets ④ and ⑤ and connects the distortion meter to the AF INPUT socket ⑦. Writes on the screen information concerning instrument settings.
- ② AF GEN key. Enables the AF generator.
- ③ SELECT key and LEDs. For selecting RF IN/OUT socket ④ or ⑤. LED lights above the socket selected.
- ④ RF IN/OUT BNC socket. For RF signal generator output levels up to 225 mV. Impedance 50 Ω .
- ⑤ RF IN/OUT N socket. For RF signal generator output levels up to 22.5 mV. Impedance 50 Ω .
- ⑥ ACCESSORY socket. DIN 7-pin connector for an external psophometric (telephone weighting) CCITT or C-MESS filter option.
- ⑦ DIST'N ON-OFF key. Causes the AF generator to modulate the signal generator with a 1 kHz tone.
- ⑧ AF INPUT socket. BNC socket for the AF input.

- ⑨ AC DC key. This key is disabled and AC automatically selected whenever DIST'N
 ⑤ or SINAD or S/N ⑨ is selected.
- ⑩ SINAD S/N key. Selects SINAD or signal/noise and causes the AF generator to modulate the signal generator with a 1 kHz tone. The display indicates when SINAD or S/N is selected.

Distortion meter operation

To make a receiver distortion measurement, proceed as follows:-

- (1) Select RX ①. RECEIVER TEST is written on the screen.
- (2) Set the signal generator to the frequency of the receiver under test (see under 'Signal generator operation').
- (3) Connect the receiver's aerial input to either the BNC socket ④ or the N socket ⑤.
- (4) Connect the receiver's audio output to the AF INPUT socket ⑧.
- (5) If required, select AF GEN ②. AUDIO TEST is written on the screen and the AF generator is enabled. See 'Audio test' below.
- (6) Press the DIST'N ON/OFF key ⑦ until DISTN is displayed. AC coupling and the 0.3 to 3.4 kHz band-pass filter are automatically selected.
- (7) Read the % distortion from the display.
- (8) If required, connect an external psophometric filter to the ACCESSORY socket ⑥. Correct connection is denoted by the display showing either CCITT or C-MESS in place of any previously selected internal filter.
- (9) Press the SINAD S/N key ⑩ until SINAD is displayed. AC coupling and the 0.3 to 3.4 kHz band-pass filter are automatically selected.
- (10) Read the SINAD in dB from the display.
- (11) Press the SINAD S/N key ⑩ until S/N is displayed.
- (12) Read the S/N in dB from the display.
- (13) To return to normal operation, select DIST'N OFF using key ⑦.

When AUDIO TEST is displayed, AF generator operation - normally a transmitter function - is enabled in addition to the receiver distortion meter. This enables the generator to supply the signal for distortion measurements, e.g. to test an audio amplifier which is connected between the AF GEN OUTPUT and the AF INPUT sockets.

Note ...

The SINAD S/N key ⑩ is inoperable during the audio test.

DUPLEX TESTING

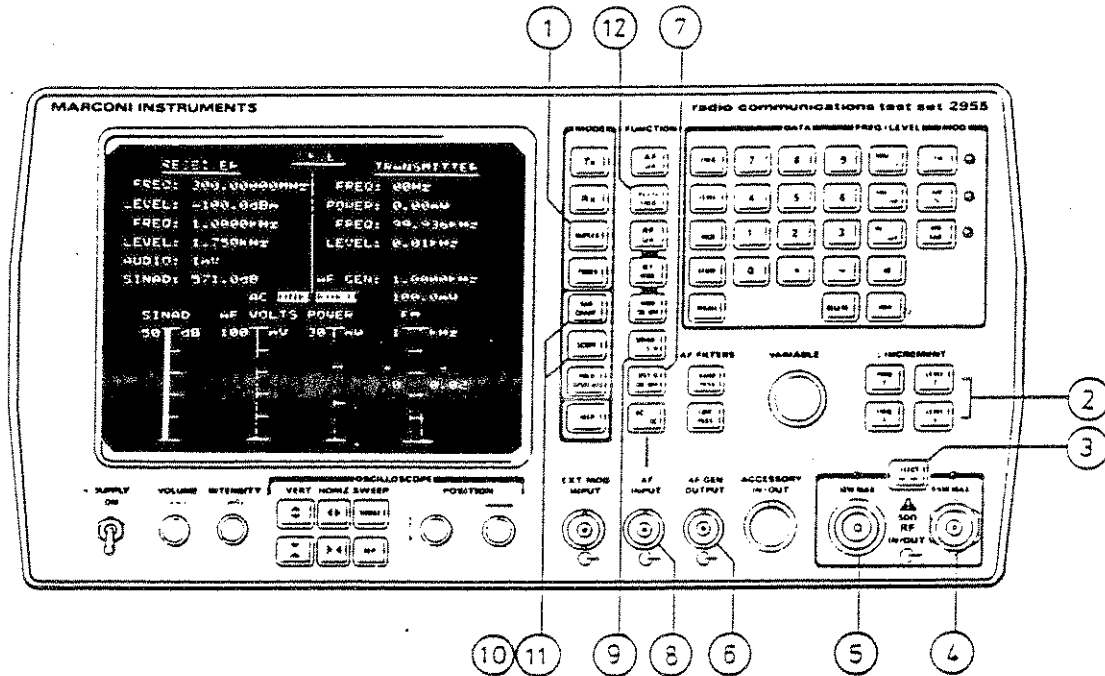

Fig. 3-10 Duplex operation controls and connectors

- ① **DUPLEX** key. Connects the RF generator to RF IN/OUT socket ④ or ⑤, the modulation meter and the power meter to socket ⑤ and the distortion meter to socket ⑧.
- ② Δ **INCREMENT** keys. Only operable when the RF generator step value has previously been set in the RX mode.
- ③ **SELECT** key. Used to select one port or two port operation.
- ④ **RF IN/OUT BNC** socket. Connects the RF generator to the receiver input for two port operation. Impedance 50 Ω .
- ⑤ **RF IN/OUT N** socket. Connects the input from the transmitter for two port operation or simultaneous input from the transmitter and output from the RF generator for one port operation. A temperature sensor detects excessive power. Impedance 50 Ω .
- ⑥ **AF GEN OUTPUT** socket. BNC output for modulating the transmitter in deviation measurements.
- ⑦ **DIST'N ON-OFF** key. Causes the AF generator to modulate the RF generator with a 1 kHz tone.
- ⑧ **AF INPUT** socket. BNC socket for the AF input for distortion or SINAD measurements.

- ⑨ SINAD S/N key. Selects SINAD or signal/noise and causes the AF generator to modulate the signal generator with a 1 kHz tone. The display indicates when SINAD or S/N is selected.
- ⑩ SCOPE key. Disabled as bar charts only are displayed in duplex mode.
- ⑪ BAR CHART key. Disabled as bar charts are always displayed in duplex mode.
- ⑫ RX=TX FREQ key. Can be used to set the RF generator to the transmitter frequency. When this key is used, it is followed by an increment key which has been preset to the appropriate offset.

Duplex operation

The following procedure assumes that both the transmitter and the receiver are modulated in the same way. If not, follow the procedures given under the appropriate transmitter and receiver test headings. Proceed as follows:-

- (1) Press DUPLEX ①. DUPLEX is displayed together with the current instrument settings under RECEIVER and TRANSMITTER headings.
- (2) Select one port operation by pressing the SELECT key ③ until ONE PORT is displayed in reverse field with the LED lit above socket ⑤.
- (3) Select two port operation by pressing the SELECT key ③ until TWO PORT is displayed in reverse field with both LEDs lit. Additionally, BNC and N are displayed in reverse field to indicate that the connections are the receiver to BNC socket ④ and the transmitter to N socket ⑤.
- (4) Set the receiver's frequency and set the signal generator frequency, level and modulation (as under these headings in 'Signal generator operation'). Note, however, that the Δ INCREMENT keys ② are only operable when the signal generator step value had previously been set in RX mode. Note also that the maximum signal generator output level is -80 dBm for one port and -54 dBm for two port operation.
- (5) Connect the receiver input to either the N socket ⑤ for one port operation or to the BNC socket ④ for two port operation.
- (6) Set the transmitter's frequency, level and modulation.
- (7) Connect the transmitter's output to the N socket ⑤ for both one and two port duplex operation.
- (8) Read the transmitter's RF power and modulation parameters from the display. Note that, for duplex mode, the bar chart display is required and therefore both the SCOPE ⑩ and BAR CHART ⑪ keys are disabled. Note also that the audio filter value is displayed under the TX side of the display but applies to both TX and RX measurements.

- (9) Connect the AF GEN OUTPUT socket (6) to the transmitter's microphone input.
- (10) Connect the receiver's audio output to the AF INPUT socket (8).
- (11) Press DISTORTION (7), SIGNAL or S/N (9) and read the receiver's distortion, SINAD or signal/noise ratio from the display.

TONES DECODING AND ENCODING

TONES OPERATION

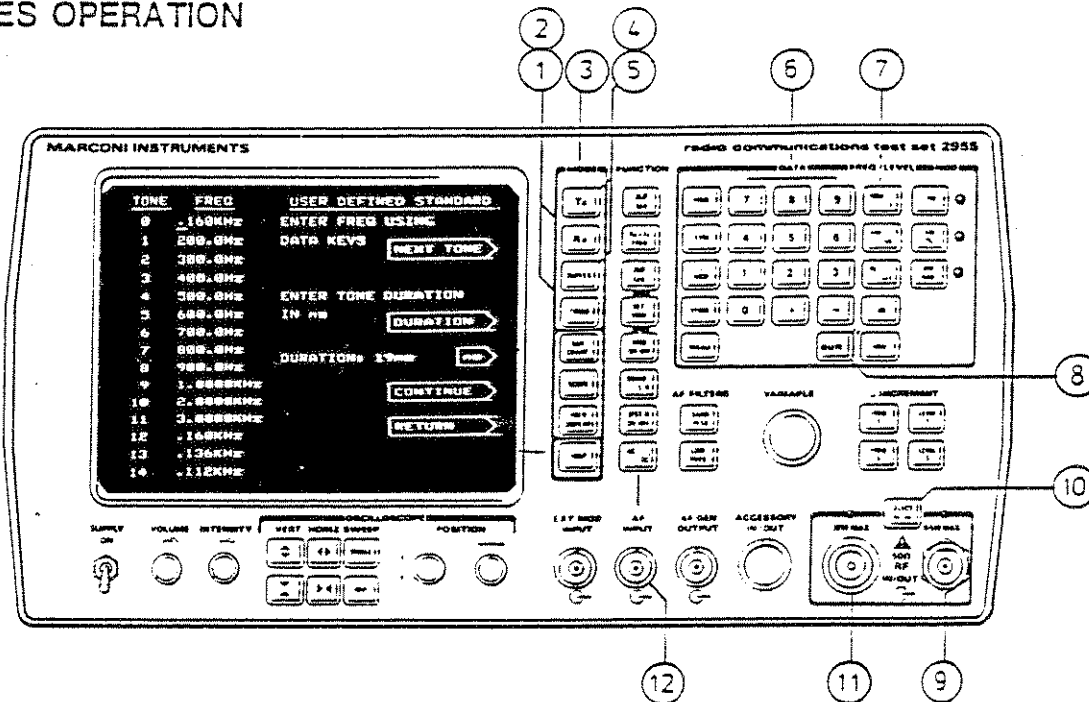

Fig. 3-11 Tones operation controls and connectors

- ① TONES key. Causes the TONES STANDARD MENU to be displayed. In duplex operation, causes the tones receiver test mode to be entered.
- ② RX key. Connects the RF generator output to RF IN/OUT sockets ⑨ and ⑪ and writes RECEIVER TEST on the screen.
- ③ MODE keys. These are used as soft keys to select programmed functions from menus which are shown alongside on the screen.
- ④ TX key. Connects the modulation meter to sockets ⑨ and ⑪ and writes TRANSMITTER TEST on the screen.
- ⑤ DUPLEX key. Connects the RF generator and modulation meter to sockets ⑨ and ⑪.
- ⑥ DATA keypad. For data entry using numerals 0 to 9, decimal point and minus sign.
- ⑦ FREQ/LEVEL keys. For defining units for frequency or level. Terminates the data entry.
- ⑧ DELETE key. Deletes a preceding digit, decimal point or minus sign entered on ⑥.
- ⑨ RF IN/OUT BNC socket. For the RF generator output for two-port duplex operation. Impedance 50 Ω .

- ⑩ SELECT key and LEDs. For selecting socket ⑪ for tones simplex operation. In duplex mode, selects one-port or two-port operation.
- ⑪ RF IN/OUT N socket. For tones simplex or one-port duplex operation. A temperature sensor detects excessive power being applied. Impedance 50 Ω .
- ⑫ AF GEN OUTPUT socket. BNC connector supplying an output in the range 20 Hz to 20 kHz for single tone modulation plus a fixed 1 kHz for two-tone modulation. Impedance 5 Ω .

Transmitter test

The tones receiver accepts up to 12 successive tones including inter-tone pauses. Frequency range is 300 Hz to 3.4 kHz, duration is 25 ms to 1.2 s and inter-tone pauses are up to 800 ms. To receive a programmed calling tone sequence, proceed as follows:-

- (1) Select TX ④. TRANSMITTER TEST is written on the screen.
- (2) Connect the output from the transmitter to the N connector ⑪.
- (3) Key up the transmitter and ensure that the instrument is correctly tuned to the transmitter's frequency.
- (4) Select TONES ① with the transmitter on. The TONES STANDARD MENU is displayed. This enables the selection of one of four tone frequency standards or of a user-defined standard or two-tone operation.
- (5) If a return to the TRANSMITTER TEST display is required, press the MODE key ③ which is arrowed by RETURN.

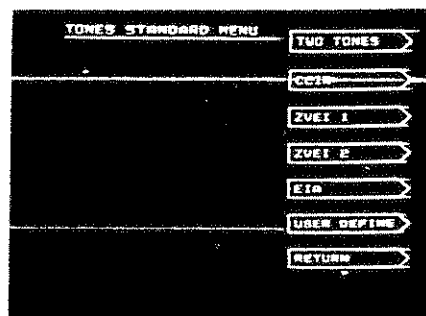

Tone frequency standard

- (6) Select the required tone frequency standard (as shown in Table 3-1) from the 4 offered on the display using the MODE key ③ which is arrowed by the frequency standard, e.g. CCIR.
- (7) TX SEQUENTIAL TONE is displayed.
- (8) Press the key arrowed by RESET. The READY prompt is displayed.

- (9) On the transmitter, activate the tones which are to be measured. When triggered, the instrument displays ACTIVE.
- (10) At the end of each measurement, ACTIVE is removed and the received tone number, frequency and % error are displayed. If it is within 5% of a standard frequency, the closest tone number is displayed along with the associated error. If the error is worse than 2%, an asterisk is displayed next to the tone number.
- (11) To return to TRANSMITTER TEST, press the key arrowed by RETURN.
- (12) To select a user-defined standard, press the key arrowed by RETURN and then reselect TONES.

User-defined standard

- (13) Define the standard by pressing the MODE key (3) which is arrowed by USER DEFINE. USER DEFINED STANDARD is displayed with the current tone numbers and frequencies.

STONE	FREQ	USER DEFINED STANDARD
0	100KHz	ENTER FREQ USING
1	200.0KHz	DATA KEYS
2	300.0KHz	NEXT TONE
3	400.0KHz	ENTER TONE DURATION
4	500.0KHz	IN ms
5	600.0KHz	DURATION
6	700.0KHz	DURATION: 17ms
7	800.0KHz	ms
8	900.0KHz	CONTINUE
9	1.000MHz	RETURN
10	2.000MHz	
11	3.000MHz	
12	4.000MHz	
13	5.000MHz	
14	6.000MHz	

- (14) When a frequency change is required, press the key which is arrowed by NEXT TONE to step the flashing cursor to the required tone number under the frequency column.
- (15) Enter the frequency using the keypad (6), ending with the frequency terminator (7). This moves the cursor down ready for the next entry.
- (16) Complete the sequence by repeating (14) and (15) as necessary.
- (17) Set the tones reception period by pressing the key which is arrowed by DURATION and then entering the duration in ms using the keys 0 to 9. Terminate by pressing the key which is arrowed by ms.

Table 3-1 TONE STANDARDS USED IN THE 2955

Tone number	CCIR	ZVEI	DZVEI	EIA*	EEA*
0	1981	2400	2200	600	1981
1	1124.6	1060.6	970	741	1124
2	1197	1160	1060.6	882.5	1197
3	1275	1270	1160	1023	1275
4	1358	1400	1270	1164	1358
5	1446	1530	1400	1305	1446
6	1540	1670	1530	1446	1540
7	1640	1830	1670	1587	1640
8	1747	2000	1830	1728	1747
9	1860	2200	2000	1869	1860
10	2400	2800	2400	459	1055
11	930	810	2600	1000	930
12	2247	970	885	1000	2247
13	991	885	825	1000	991
14	2110	2600	810	1000	2110
Duration	100 ms	70 ms	70 ms	33 ms	40 ms
Extended	700 ms	700 ms	700 ms	330 ms	400 ms

All frequencies are shown in Hz.

*As supplied, each 2955 is programmed either for EEA (European) or for EIA (North American). EEA or EIA is shown on the display.

(18) Press the key which is arrowed by CONTINUE to return to TX SEQUENTIAL TONE.

(19) Press the key which is arrowed by RETURN to return to TRANSMITTER TEST.

Two tone generation

(20) Select two tone operation by pressing the MODE key (3) which is arrowed by TWO TONES. The TWO TONE menu is displayed.

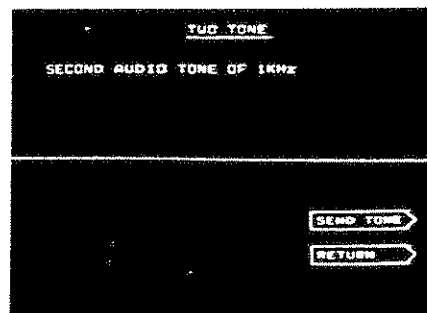

(21) Press SEND TONE and then return to TRANSMITTER TEST. 2T is shown in reverse video on the display and a 1 kHz tone in addition to the variable frequency output is connected to the AF GEN OUTPUT socket (12). The level is that set previously for the variable frequency.

(22) To return to single tone operation, press TONES (1) and then the key which is arrowed by TWO TONES. Press the key which is arrowed by STOP TONE and then return to TRANSMITTER TEST.

Receiver test

To generate a programmed calling tone sequence, proceed as follows:-

(1) Select RX (2). RECEIVER TEST is written on the screen.

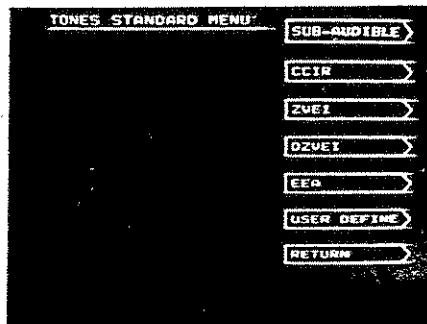

(2) Connect the receiver input to either the BNC socket (8) or the N socket (11).

(3) Press SELECT (10) until the LED lights above the selected output socket.

(4) Select TONES (1). The TONES STANDARD MENU is displayed enabling the selection of one of four tone frequency standards or of a user-defined standard or of a sub-audible tone.

(5) When a return to RECEIVER TEST is required, press the MODE key (3) which is arrowed by RETURN.

Sub-audible tone

(6) Select a sub-audible tone by pressing the MODE key (3) which is arrowed by SUB-AUDIBLE. RX SUB-AUDIBLE TONE is displayed together with the current sub-audible tone frequency, level and modulation. As shown on the display, the internal signal generator is now modulated by a fixed 1 kHz tone.

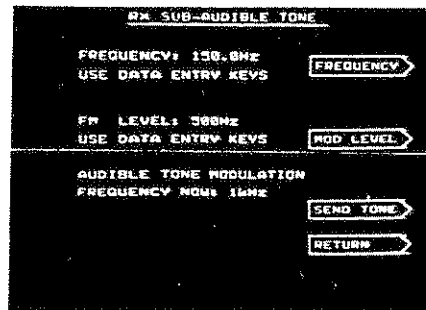

(7) Press the key which is arrowed by FREQUENCY and set the second. variable frequency using the keypad (6), ending with the frequency terminator (7).

(8) Press the key which is arrowed by MOD LEVEL and set the level using the keypad (6), ending with the level terminator (7).

(9) Generate the sub-audible tone by pressing the key which is arrowed by SEND TONE. The SEND TONE arrow changes to STOP TONE to enable tone generation to be halted. When two-tone modulation is in operation, SAT is displayed in reverse video against the 1 kHz modulation frequency.

(10) To return to RECEIVER TEST, press the key which is arrowed by RETURN.

(11) To select either a tone frequency or a user-defined standard, press the key which is arrowed by RETURN and then reselect TONES.

Tone frequency standard

(12) Select the required tone frequency standard from the 4 offered on the display using the MODE key (3) which is arrowed by the frequency standard, e.g. CCIR.

(13) RX SEQUENTIAL TONE is displayed with a flashing cursor under the TONE heading awaiting a tone number entry. Up to 11 of the tones in the chosen standard can be selected in the order required.

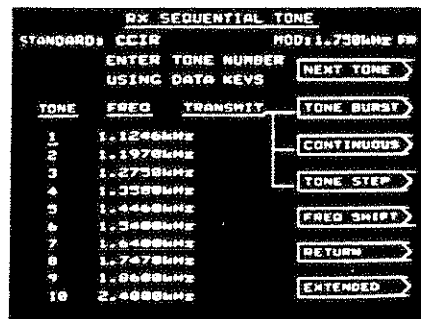

(14) Enter the tone number using the keypad (6) and press the key which is arrowed by NEXT TONE to terminate the entry. This causes the frequency to be displayed against the entered tone number and moves the cursor down ready for the next entry.

(15) To create an inter-tone pause, press the key which is arrowed by NEXT TONE without entering a tone number. Repeat for multiples of the tone duration. Then, when the next tone number is entered, NULLs are displayed. A pause may be created in place of an entered frequency by moving the cursor appropriately and then pressing DELETE (8).

(16) To select an extended tone (of 10 times the tone duration up to 700 ms unless user-defined) for the 5th from last tone, press the MODE key which is arrowed by EXTENDED. This facility is used for scanning receivers to ensure capture of the first tone. The letter E is displayed alongside the altered tone frequency. No response is made if less than 5 frequencies have been selected. The EXTENDED arrow changes to CANCEL E. Press this key to revert to normal tones operation.

RX SEQUENTIAL TONE		
STANDARD:	CCIR	MODE: 1.738kHz FR
	ENTER TONE NUMBER	NEXT TONE
	USING DATA KEYS	
TONE	FREQ	TRANSMIT
1	1.1246kHz	TONE BURST
2	1.1976kHz	CONTINUOUS
3	1.2736kHz	TONE STEP
4	1.3506kHz	FREQ SHIFT
5	1.4286kHz	RETURN
6 E	1.5086kHz	CANCEL E
7	1.5886kHz	
8	1.7476kHz	
9	1.8686kHz	
10	2.4086kHz	

(17) Complete the tone sequence by repeating (14) as necessary.

(18) Generate the tones sequences by pressing the key which is arrowed by TONE STEP, TONE BURST or CONTINUOUS as required. The CONTINUOUS arrow changes to STOP TONES to enable the continuous operation to be halted.

(19) If required, select a frequency offset in the range + and - 9% by pressing the key which is arrowed by FREQ SHIFT. Enter the offset using one of the keys 0 to 9 with a minus sign when appropriate. All the previously selected tone frequencies are reset and displayed.

(20) To return to RECEIVER TEST, press the key which is arrowed by RETURN. If CONTINUOUS has been selected, the tones continue to be transmitted.

(21) To select either a user-defined standard or a sub-audible tone, press the key which is arrowed by RETURN and then reselect TONES.

User-defined standard

(22) Define the standard by pressing the MODE key (3) which is arrowed by USER DEFINE. USER DEFINED STANDARD is displayed with the tone numbers and frequencies.

(23) Press the key which is arrowed by NEXT TONE to step the flashing cursor to the required tone number under the FREQ column.

(24) Any frequency between 20 Hz and 20 kHz can be assigned to any tone number between 0 and 14. Increment sizes for the tone frequencies are 0.1 Hz from 20 Hz to 3.2766 kHz and 1 Hz from 3.277 kHz to 20 kHz. Enter the frequency using the keypad (6), ending with the frequency terminator (7). This moves the cursor down ready for the next entry.

(25) Complete the sequence by repeating (23) and (24) as necessary.

(26) Set the tones generation period by pressing the key which is arrowed by DURATION and then entering the duration in ms using the keys 0 to 9. Terminate by pressing the key which is arrowed by ms.

(27) To select the required tone sequence, press the key which is arrowed by CONTINUE to return to RX SEQUENTIAL TONE.

Note ...

Extended tones are always 10 times the user-defined duration.

(28) To return to RECEIVER TEST, press the key which is arrowed by RETURN.

Note ...

This user-defined data is stored in non-volatile memory.

Duplex mode

To generate a programmed calling-tone sequence in duplex mode, proceed as follows:-

- (1) Follow the instructions for interconnections and general operating procedures given under 'Duplex operation'.
- (2) Continue from (4) of 'Receiver test'.

Note ...

Tones cannot be received in duplex mode. To test the reception of a calling tones sequence, leave duplex mode by following the instructions given under 'Transmitter test'.

HELP KEY OPERATION

HELP KEY

When the HELP key is pressed, the HELP menu is displayed which enables you to obtain an operating summary, provides a choice of alternative parameters and implements the self test routines. To return to the operating mode press the key arrowed by RETURN.

Operating summaries

Pressing one of the MODE keys arrowed by the following provides an operating summary to enable you to implement the selected test.

TRANSMITTER TESTING
 RECEIVER TESTING
 DUPLEX TESTING
 AUDIO TESTING

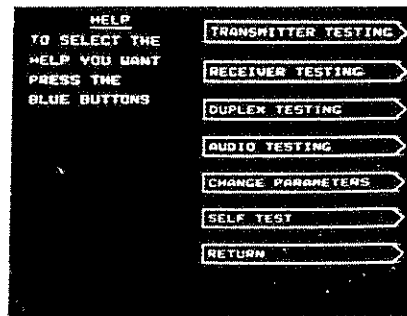

The HELP ON TESTING operating summary is then displayed – see Fig. 3-12. This includes information upon key operation, e.g. to select TRANSMITTER TEST the TX key must be pressed. But note that this is for information only: it is necessary to press the mode key arrowed by RETURN twice (once to return to the HELP menu and once to return to the operating mode) before pressing the designated key.

Where summaries occupy two pages, press the mode key arrowed by CONTINUE to change from one page to another. Return to the HELP menu by pressing the key arrowed by RETURN.

Alternative parameters

Pressing the MODE key arrowed by CHANGE PARAMETERS causes the PARAMETERS menu to be displayed. To change between the two menu pages, press CONTINUE. The arrowed keys all toggle between two states, the selected parameter being shown under the SET TO heading in the following display:–

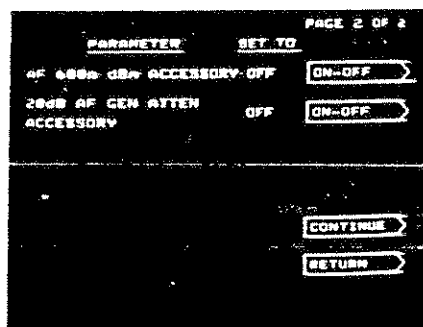
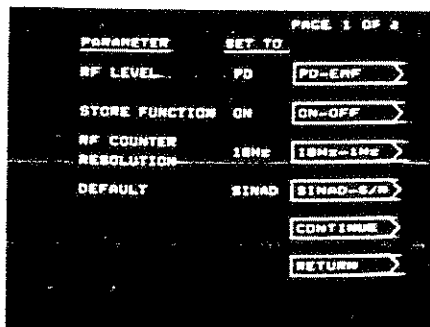

*The r.f. counter resolution will be set to 1 Hz providing the frequency is below 200 MHz.

Return to the HELP menu by pressing the key arrowed by RETURN.

```

HELP ON TRANSMITTER TESTING
TO SELECT          PRESS BUTTONS
TRANSMITTER TEST  TX
MOD TYPE          FR/AM/FM
DEMOD BANDWIDTH   BANDPASS/LOWPASS *
DEMOD DISPLAY     SCOPE
DISTORTION        DISTN - 1kHz ONLY
RECEIVED TONES   TONES
TX FREQ           TX*FREQ+(NUMBERS)+
                MHz/kHz/Hz

TO ADJUST AF GEN PRESS [NUMBER]+[MODE]+
[NUMBER]+(NUMBERS)+FREQ/LEVEL
TERMINATOR AS REQUIRED.
REVERSE FIELD DISPLAY ASSIGNED TO
VARIABLE.
* LOWPASS TOGGLES 2 FILTERS
    
```

Transmitter testing

```

HELP ON AUDIO TESTING
TO SELECT          PRESS BUTTONS
AUDIO TEST        RN-AF GEN
VOLTS BANDWIDTH  BANDPASS/LOWPASS *
dB RELATIVE      dB(TOGGLES dBV/dB)
DISTORTION       DISTN - 1kHz ONLY
TWO TONE OUTPUT  TONES

TO ADJUST AF GEN PRESS [NUMBER]+[MODE]+
[NUMBER]+(NUMBERS)+FREQ/LEVEL
TERMINATOR AS REQUIRED.
REVERSE FIELD DISPLAY ASSIGNED TO
VARIABLE.
IF DC SELECTED VOLTS READING
IS TRUE RMS DC+AC VOLTS.
* LOWPASS TOGGLES 2 FILTERS
SCOPE BANDWIDTH IS 50kHz FIXED.
    
```

Audio testing

```

HELP ON RECEIVER TESTING 1 OF 2
TO SELECT          PRESS BUTTONS
RECEIVER TEST     RX
VOLTS BANDWIDTH   BANDPASS/LOWPASS *
DISTORTION        DISTN - 1kHz ONLY
dB VOLTS          DISTN TWICE IF SINAD
                OR S/N, ONCE IF DISTN
dB RELATIVE       dB(TOGGLES dBV/dB)
TRANSMIT TONES   TONES

DC COUPLING CANNOT BE SELECTED IF
SINAD S/N OR DISTN IS ON.
IF DC SELECTED VOLTS READING
IS TRUE RMS DC+AC VOLTS.
* LOWPASS TOGGLES 2 FILTERS
SCOPE BANDWIDTH IS 50kHz FIXED.
    
```

Receiver testing

```

HELP ON RECEIVER TESTING 2 OF 2
TO ADJUST          PRESS BUTTONS
AF GEN            RF GEN+[INCR]+FREQ/LEVEL+
                (NUMBERS)+FREQ/LEVEL
                TERMINATOR
MODULATION        SET MOD+[INCR]+FREQ/LEVEL+
                (NUMBERS)+FREQ/LEVEL
                TERMINATOR/NO TERMINATOR

REVERSE FIELD DISPLAY ASSIGNED TO
VARIABLE.
    
```

```

HELP ON DUPLEX TESTING 1 OF 2
TO SELECT          PRESS BUTTONS
DUPLEX TEST       DUPLEX
AF DISTORTION     DISTN - 1kHz ONLY
dB VOLTS          DISTN TWICE IF SINAD
                OR S/N, ONCE IF DISTN
dB RELATIVE       dB(TOGGLES dBV/dB)
TRANSMIT TONES   TONES

VOLTS BANDWIDTH AND DEMOD BANDWIDTH ARE
DETERMINED BY RECEIVER TEST SETTINGS.
DC COUPLING CANNOT BE
SELECTED IF SINAD S/N OR DISTN
IS ON.
IF DC SELECTED VOLTS READING
IS TRUE RMS DC+AC VOLTS.
    
```

Duplex testing

```

HELP ON DUPLEX TESTING 2 OF 2
TO ADJUST          PRESS BUTTONS
AF GEN            RF GEN+FREQ/LEVEL+
                (NUMBERS)+FREQ/LEVEL
                TERMINATOR
MODULATION        SET MOD+LEVEL+(NUMBERS)+
                FREQ/LEVEL TERMINATOR/NO
                TERMINATOR
AF GEN            AF GEN+LEVEL+(NUMBERS)+
                FREQ/LEVEL TERMINATOR

AF GEN FREQ/LEVEL INCREMENTS
ARE DETERMINED BY RECEIVER TEST
SETTINGS.
REVERSE FIELD DISPLAY ASSIGNED TO
VARIABLE.
    
```

Fig. 3-12 HELP ON TESTING operating summaries.

Self test

Pressing the MODE key arrowed by SELF TEST causes the instrument to implement the self test procedures. At the end of each of the thirteen tests either PASSED or FAILED appears against the test number. In the case of a failed test, the error code for the failure is shown. At any time, the self test may be terminated by pressing the key arrowed by RETURN. At the end of the tests the instrument waits for RETURN, which displays the HELP menu.

SELF TEST		
TEST		ERROR CODE
1.0	FAILED	11
1.1	PASSED	
1.2	PASSED	
1.3	PASSED	
1.4	PASSED	
2.0	PASSED	
2.1	PASSED	
2.2	PASSED	
2.3	PASSED	
2.4	PASSED	
3.1	PASSED	
3.2	PASSED	
3.3	PASSED	

RETURN →

Note...

When using self test, remove any leads connected to the coaxial inlets and outlets in order to prevent the possibility of extraneous pick-up affecting the readings.

TEST ROUTINES

When a test fails during SELFTEST, it may be restarted as follows:-

When TEST FAILED appears during SELF TEST, the error code defining the source of error may be obtained as follows:-

(1) Press HELP then the key arrowed by CHANGE PARAMETERS. The CHANGE PARAMETERS menu is displayed.

(2) Press the TX key. The SELFTEST menu is displayed.

(3) Press the key arrowed by NEXT TEST to start the testing process. During each test, ACTIVE is displayed.

(4) When each test is completed, the test number is shown together with PASS or FAIL. If failure has occurred, the appropriate error code additionally appears. For the meaning of the code, refer to Tables 3-2a to -2c.

(5) To single step to the next test, press the key again (causing ACTIVE to reappear) or—to cause a sequence of tests—press the key repeatedly. Test numbers range from 1.0 to 3.3 in steps of 0.1. Selecting NEXT TEST following test 3.3 will restart the test sequence from 1.0.

SELF TEST			NEXT TEST →
TEST		ERROR CODE	
1.0	FAILED	11	
1.1	PASSED		
1.2	PASSED		
1.3	PASSED		
1.4	PASSED		

RETURN →

TABLE 3-2a ERROR CODES FOR TEST 1: CHECK RF COUNTER AGAINST SIG. GEN. FREQUENCY

CODE (hex.)	
10	- Test passed
11	- FREQ 0* fails - HIGH FREQ (>50 Hz above set frequency)
12	- FREQ 0 fails - LOW FREQ (>50 Hz below set frequency)
13	- FREQ 1 fails - HIGH FREQ
14	- FREQ 1 fails - LOW FREQ
15	- FREQ 2 fails - HIGH FREQ
16	- FREQ 2 fails - LOW FREQ
17	- FREQ 3 fails - HIGH FREQ
18	- FREQ 3 fails - LOW FREQ
19	- FREQ 4 fails - HIGH FREQ
1A	- FREQ 4 fails - LOW FREQ
1B	- Frequency read fails

* FREQ 0 = 20 MHz (sig. gen. mixed range) FREQ 2 = 218 MHz (sig. gen. oscillator 1)
 FREQ 1 = 111 MHz (sig. gen. divided range) FREQ 3 = 340 MHz (sig. gen. oscillator 2)
 FREQ 4 = 480 MHz (sig. gen. oscillator 3)

TABLE 3-2b ERROR CODES FOR TEST 2: CHECK RF POWER METER AGAINST SIG. GEN.

CODE (hex.)	
20	- Test passed
21	- FREQ 0* fails - LOW POWER (>2 dB below set level)
22	- FREQ 0 fails - HIGH POWER (>2 dB above set level)
23	- FREQ 1 fails - LOW POWER
24	- FREQ 1 fails - HIGH POWER
25	- FREQ 2 fails - LOW POWER
26	- FREQ 2 fails - HIGH POWER
27	- FREQ 3 fails - LOW POWER
28	- FREQ 3 fails - HIGH POWER

	Sig. gen. setting	Power meter reading
FREQ 0 = 300 MHz	0.25 mW	79 mW
FREQ 1 = 849 MHz	0.25 mW	79 mW
FREQ 2 = 20 MHz	0.25 mW	79 mW
FREQ 3 = 20 MHz	0.125 mW	40 mW

Note...
 The difference in setting and reading is due to 1 port duplex selection for the test.

TABLE 3-2c ERROR CODES FOR TEST 3: CHECK MODULATION FREQUENCY AND LEVEL

CODE (hex.)

30 Test passed

Test 3.0 - Mod. freq. 400 Hz. level 5 kHz

31 Mod. freq. fails*

33 Mod. level fails - low**

34 Mod. level fails - high

Test 3.1 - Mod. freq. 1 kHz. level 5 kHz

32 Mod. freq. fails

35 Mod. level fails - low

36 Mod. level fails - high

Test 3.2 - Mod. freq. 1 kHz. level 50%

37 Mod. level fails - low

38 Mod. level fails - high

Test 3.3 - Mod. freq. 1 kHz. level 5 rads

39 Mod. level fails - low

3A Mod. level fails - high

*Fails mod. freq. - Measured freq. more than 1 Hz away from setting.

**Fails mod. level - Measured mod. level more than 10% away from setting.

RF frequency set to 210 MHz.

GPIB OPERATION

GENERAL PURPOSE INTERFACE BUS (GPIB)

Functions

The GPIB* interface unit allows the instrument to be coupled to a controller. The essential purpose of the GPIB functions is described below. Further information on the general features and applications of the GPIB system can be obtained from the separate GPIB Manual offered as an optional accessory (see Chap. 1, Accessories).

Setting the GPIB address

The instrument's talk and listen addresses can be selected on the rocker switch bank illustrated in Fig. 3-13. This is positioned on the GPIB unit to the right of the connector and is accessible at the rear panel. GPIB switch settings are summarized in Table 3-3.

Note...

If the address is changed, the instrument must be switched off then back on to enable the instrument to read the new GPIB address.

For talk and listen mode: Set switch 6 to 0 e.g. XXXXX0 where X = 0 or 1 to form an address in the range 0 to 30 decimal.

For talk only mode: Set switch 6 to 1 and switches 1 and 2 as required for the following:-

Switch	1	2	3	4	5	6	
0	0	X	X	X	X	1	Upper and lower case. <CR> suppressed.
0	1	X	X	X	X	1	Upper and lower case. <CR> not suppressed.
1	0	X	X	X	X	1	Upper case only. <CR> suppressed.
1	1	X	X	X	X	1	Upper case only. <CR> not suppressed.

X = Don't care.

Note...

If any switch position is changed, the instrument must be switched off and then back on to enable the instrument to read the new setting.

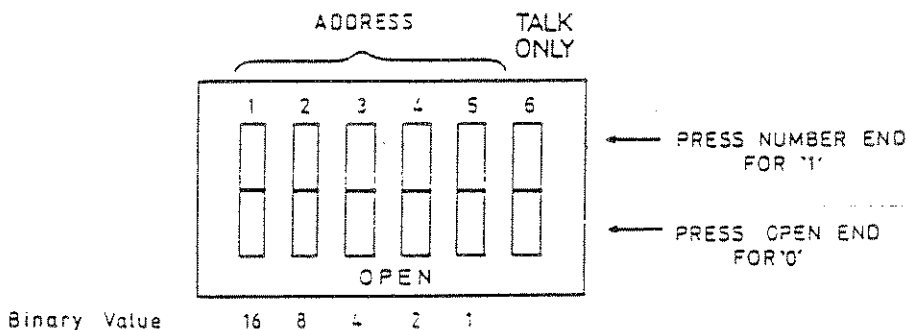

Fig. 3-13 GPIB address rocker switch bank

* Where GPIB is Marconi Instruments implementation of the General Purpose Interface Bus in accordance with IEEE Standard 488-1978 and IEC Publication 625-1 (First Edition).

TABLE 3-3 GPIB SWITCH SETTINGS

Switch	Bit	Function	
		Talker/Listener	Talk only
1	4	MS address bit	Upper case characters only (for machines with upper case only)
2	3	Address bit	Suppress carriage return in output (for dedicated printer units)
3	2	Address bit	Not used
4	1	Address bit	Not used
5	0	LS address bit	Not used
6	5	0 = talker/listener	1 = talk only

Capability identification codes

These are defined by IEEE Std. 488-1978. The capabilities are as follows:-

SH1: Source handshake (complete capability)

The source handshake sequences the transmission of each data byte from the instrument over the bus data lines. The sequence is initiated when the function becomes active, and the purpose of the function is to synchronize the rate at which bytes become available to the rate at which accepting devices on the bus can receive the data.

AH1: Acceptor handshake (complete capability)

The acceptor handshake sequences the reading of the data byte from the bus data lines.

T5: Talker function (complete capability)

The talker function provides the 2955 with the ability to send device dependent messages over the bus to other devices. The ability of any device to talk exists only when it has been designated as a talker by the controller.

TE0: Extended talker (no capability)

L4: Listener function (no listen only function)

The listener function provides a device with the ability to receive device dependent messages over the bus. The ability of any device to listen exists only when it has been designated as a listener by the controller.

LE0: Extended listener (no capability)

SR1: Service request function (complete capability)

The service request function gives the 2955 the capability to inform the controller when it requires attention.

RL1: Remote/local function (complete capability)

The remote/local function allows the 2955 to be controlled either by the local front panel keys or by device dependent messages over the bus.

PP0: Parallel poll function (no capability)

DC1: Device clear function (complete capability)

Device clear is a general reset and may be given to all devices in the system simultaneously (DCL). 2955 resets to the power-up mode.

DT1: Device trigger function (complete capability)

Device trigger is used by the 2955 to initiate a sequential tone sequence.

C0: Controller function (no capability)

E1: Open collector drivers

The GPIB drivers have open collector, rather than tri-state outputs.

Display annunciators

During GPIB operation, the following announcements are made on the screen:-

Remote: Once the instrument has received a remote enable and has been addressed, it will enter the remote state. This is announced by REM appearing in reverse field in the bottom right-hand corner of the screen.

Addressed: When in the remote condition and the instrument is addressed to either talk or listen, this is announced by ADR appearing in reverse field in the bottom right-hand corner of the screen.

Service request: When in the remote condition and enabled, a service request is raised, this is announced by SRQ appearing in reverse field in the bottom right-hand corner of the screen.

Local: When in the remote condition and Local Lockout (LLO) has not been sent, this is announced by LCL appearing next to the HELP key. Pressing HELP will then cause the instrument to enter a Go To Local (GTL) condition.

Note that the Go To Local condition is not the same as the power-on condition since the remote enable (REN) line from the controller will still be active.

GPIB commands

Commands take the form of a two-character alphabetic pair which may be followed by amplifying, non-exponential numeric data. Separators are required for multiple data and for multiple commands forming a string.

Command format

This takes the form of <HEADER> <DATA> <TERMINATOR/SEPARATOR>

- <HEADER> – A two-character command identifier.
- <DATA> – In form NR1 (integer) or NR2 (fixed decimal point), i.e. exponential formats are not allowed. Where there is more than one item of data, separators must be used.
- <TERMINATOR/SEPARATOR> – Used to delimit commands in command strings. Can be omitted if unambiguous.
- <: > <.> <CR> – Command separators.
- <LF> <ETX> <ETB> <EOI> – Command string delimiters/terminators. Note that <EOI> must only be sent with the last character.
- <SPACE> – Ignored by the system – used for intelligibility only.

The example which follows shows the format of a command string where the data items are separated by commas, the commands are delimited by semicolons and the string is terminated by EOI:-

PO40.3 ; PO41.5 ; <EOI> – Poke 3 and 5 to memory locations 40 and 41 respectively.

Notes...

- (1) Certain commands cause the instrument to output more data than it can store in its output buffer, e.g. SV and RD39, see 'Non-keyboard commands' below. The result is that the data is held off from entering the buffer and hence the instrument stops.

To prevent locking up the instrument, a 2 second timeout takes effect. If data output has not been started, or is read out slower than 1 character per 2 seconds, then a buffer overflow error is raised and the instrument aborts the command.

- (2) The input buffer length is 128 characters. If the buffer overflows, then the GPIB is held off until further space is available. If however, the buffer does not contain a command delimiter then the data is lost and an error is raised. This is because command interpretation, and hence buffer unloading, does not occur until a command string delimiter is received.

- (3) If a syntax error is detected, then that command and all subsequent commands up to the next command separator are aborted and an error is raised.
- (4) When Device Clear is used, it is recommended that a 0.5 s wait period follows while re-initialization of the instrument occurs. This avoids corruption or loss of GPIB commands.

Data output format

Every request for data will cause a response from the instrument. The form of the response will be that outlined below. Note that if no data is available the default response is NULL. Each reading will have its own terminator sequence but the <EOI> terminator is only sent once the output buffer is empty.

The format takes the form of <HEADER> <DATA FIELD> <TYPE FIELD> <TERMINATOR>

- <HEADER> - Data is only sent in this field if a description is necessary, e.g. WHOLE PAGE.
- <DATA FIELD> - This field contains the reading, it may be a numerical or alpha string. There is no fixed format except that numerical data will conform to NR1 or NR2 data types (i.e. non-integer).
- <TYPE FIELD> - Data is only sent in this field if the data in the data field requires qualifying e.g. MHz, dBm, etc.
- <TERMINATOR> - All readings are terminated with <CR> <LF>. This enables minimum interaction between a controller and a printer. Note that <ETX> <EOI> is sent when the output buffer is empty and ETX is selected.

Keyboard-equivalent commands

Below are listed the GPIB commands that perform the functions of the keys named alongside. Note however, that for the numeric, minus sign and decimal point keys, the normal ASCII equivalents are used. The commands are summarized in Fig. 3-14.

Command	Key	Function
TX	TX	Transmitter mode
RX	RX	Receiver mode
DX	DX	Duplex mode
TN	TONES	Tones mode
BC	BAR CHART	Bar chart
SC	SCOPE	Oscilloscope (if requested in duplex then the lower half of the screen is cleared and the bar charts are disabled)
HDn	HOLD DISPLAY	Hold display [off, on : n=0,1]
HP	HELP	Help
AG	AF GEN	AF generator
RT	RX=TX FREQ	Set RX to TX frequency
RG	RF GEN	RF generator
SM	SET MOD	Set modulation
MDn	MOD ON/OFF	Modulation switch [off, on : n=0,1]
SNn	SINAD S/N DIST'N	Off, default (SINAD or S/N), non-default (SINAD or S/N), distortion [n=0,1,2,3]
AC	AC/DC	AC coupling
DC	AC/DC	DC coupling

OPERATION

Command	Key	Function
FR	FREQ	Frequency
LV	LEVEL	Level
DI	Δ INCR	Increment/decrement
STnn	STORE	Store settings [nn=01 to 38]
RCnn	RECALL	Recall settings [nn=00 to 38]
MZ	MHz/V	Megahertz
KZ	kHz/mV	Kilohertz
HZ	Hz/μV	Hertz
VL	MHz/V	Volts
MV	kHz/mV	Millivolts
UV	Hz/μV	Microvolts
DB	dB	Decibels
DM	dBm	Decibels relative to 1 mW
FM	FM	Frequency modulation
AM	AM%	Amplitude modulation
PM	øM RAD	Phase modulation
FI _n	BAND PASS	BP filter [300 Hz-3.4 kHz : n=0]
FT _n	LOW PASS	LP filter [15/50 kHz, 300 Hz : n=1,2]
FU	FREQ ↑	Frequency increment
FD	FREQ ↓	Frequency decrement
LU	LEVEL ↑	Level increment
LD	LEVEL ↓	Level decrement
SW	SINGLE	Scope single sweep and arm
RP	REP	Scope repetitive sweep
VD		Scope vertical scale increment
VU		Scope vertical scale decrement
TD		Scope horizontal timebase increment
TU		Scope horizontal timebase decrement
IP _n	SELECT	Input socket select [BNC, N-type, one port duplex: n=0,1,2]
XA	TX	Soft key A
XB	RX	Soft key B
XC	DX	Soft key C
XD	TONES	Soft key D
XE	BAR CHART	Soft key E
XF	SCOPE	Soft key F
XG	HOLD	Soft key G

ASCII (decimal)	Function
19	Reverse field '7'
20	'\$'
21	'#'
22	Bell character
23	Graphics character (unused)
24	'?'
25	'@'
26	Copyright symbol
27	Graphics character (unused)
28	'('
29	'['
30	']'
31	Reverse field space
*32	Space
33	's'
34	'z'
35	Underline
36	'μ'
*37	'%'
38	'Ω'
39	'm'
40	'd'
41	'k'
42	'ø'
*43	'+'
*44	','
*45	'-'
*46	':'
*47	'/'
*48-57	'0' to '9'
*58	'.'
59	Reverse field top
60	Graphics character (unused)
61-64	Box characters
*65-90	'A' to 'Z'
91-92	Box characters
93	')'
94-95	Box characters
96	Pointer character
97-122	Reverse field 'A' to 'Z'
123-125	Graticule characters
126	Down arrow
127	Up arrow
128	Graphics character (unused)
129-191	Scope graticule characters
192	Flashing graphics character
193-218	Flashing 'A' to 'Z'
219-223	Flashing graphics characters
224-255	Dim bar chart characters

*Denotes standard ASCII characters.

Command	Function	
DS	Disable screen output	} Details on the use of these commands are given under 'Screen commands' later on in this chapter.
ES	Enable screen output	
CS	Clear screen	
RS	Restore screen	
PG	Purges output buffer. Clears data available flag but SRQ remains raised.	
POm.n	Pokes data n into location m. Note that this command includes a 10 ms delay for EEPROMs. Data cannot be poked to the display since it is not memory mapped (use the WR command).	
DUIm.n	As for PO but continues storing bytes until a terminator is received or a maximum of 64 bytes. Note that this command includes a 10 ms delay for EEPROMs.	
TF	Tells instrument to record sequential tone frequencies.	
TE	Tells instrument to record sequential tone numbers and errors:	
LF	This causes the instrument to send <EOI> with <LF>. This is the default condition and will suit most controllers. However, care should be taken when there are multiple readings in the output buffer as data could be lost.	
EX	This causes the instrument to send <EOI><ETX> when the output buffer is empty. <LF> is sent embedded between readings.	
ET	Enable r.f. directional power head if fitted.	
DT	Disable r.f. directional power head.	
PR	Select peak envelope power for r.f. directional power head.	
CR	Select CW power for r.f. directional power head.	
SP	Suppress GPIB annunciators (cleared by RS).	
BXn.m	Put up soft key boxes (used to arrow the mode keys). Where n = box pattern, m = length of box. Details on the use of this command are found under 'BX (BoX) command' later on in this chapter.	
BP	Beep, sound a tone in the loudspeaker. Note that the loudness is determined by the VOLUME control setting.	

READINGS

SV	When next addressed to talk, will send a data string which, when sent back to the instrument, will restore current settings see note (1) under 'Command format'.		
PEm	When addressed to talk, will send data at location m. Note that variable areas only can be accessed.		
RDn	When addressed to talk, will send reading or setting specified in n as follows:-		
	1	RF counter frequency	Reading
	2	RF power	Reading
	3	Modulation frequency	Reading
	4	Modulation level	Reading
	5	AF counter frequency	Reading
	6	AF level	Reading
	7	RX distortion: SINAD: S.N	Reading
	8	TX distortion	Reading
	9	Modulation peak: +ve deviation	Reading
	10	Modulation trough: -ve deviation	Reading
	11	RF forward power	Reading
	12	RF reflected power	Reading

OPERATION

13	VSWR: return loss	Reading
14	Sequential tone 1	Reading
15	Sequential tone 2	Reading
16	Sequential tone 3	Reading
17	Sequential tone 4	Reading
18	Sequential tone 5	Reading
19	Sequential tone 6	Reading
20	Sequential tone 7	Reading
21	Sequential tone 8	Reading
22	Sequential tone 9	Reading
23	Sequential tone 10	Reading
24	Sequential tone 11	Reading
25	Sequential tone 12	Reading
26	Sequential tone standard	Setting
27	RF generator frequency	Setting
28	RF generator level	Setting
29	AF generator frequency	Setting
30	AF generator level	Setting
31	Modulation frequency	Setting
32	Modulation level	Setting
33	RF frequency increment	Setting
34	RF level increment	Setting
35	AF frequency increment	Setting
36	AF level increment	Setting
37	Mod frequency increment	Setting
38	Mod level increment	Setting
39	Whole page readings and settings (RX, TX and DX only)--see Note (1) under 'Command format' above).	

ER When next addressed to talk, will send the code for the last error detected.

VN When next addressed to talk, will send the software version number.

SK When next addressed to talk, will send an ASCII character corresponding to the last key pressed. The ASCII characters corresponding to the keys are shown in Fig. 3-15.

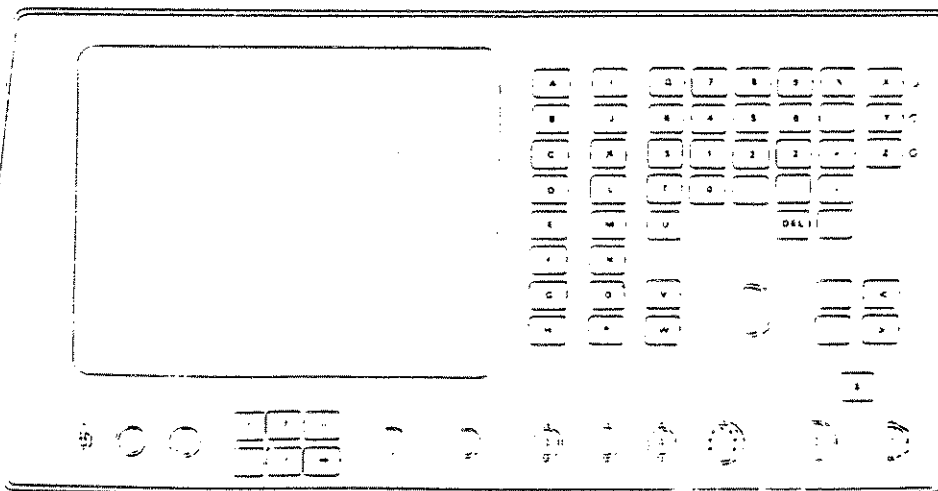

Fig. 3-15

ASCII characters sent (corresponding to last key pressed) when SK command is used in GPIB operation.

Operating example

Set the signal generator to 123.5 MHz (with increment/decrement step set to 100 kHz) at a level of -30 dBm modulated by 1.0 kHz a.m. at 50% preparatory to measuring signal to noise ratio. The following string is sent after addressing the instrument as a listener:-

RX:RG:FR123.5MZ:DI100KZ:LV-30DM:SM:FR1KZ:LV50AM:MD1:AC:SN2<LF>

This breaks down as follows:-

RX	Receiver test
RG	RF generator
FR123.5MZ	Frequency 123.5 MHz
DI100KZ	Delta increment 100 kHz
LV-30DM	Level -30 dBm
SM	Set modulation
FR1KZ	Frequency 1 kHz
LV50AM	Level 50% a.m.
MD1	Modulation on
AC	AC coupled
SN2	Signal/noise

When ready, the level and distortion results can be selected for reading by sending the following:-

RD6<LF>RD7<LF>

Then the instrument is addressed as a talker to receive the result.

Trigger

The bus trigger system can be used to start the transmission of a tone burst whilst the instrument is in the RX mode. However, the tone sequence must have been previously set up. Typical trigger commands include Selective Device Trigger (SDT) and Group Execute Trigger (GET).

Service requests (SRQ) and status byte

When enabled, the 2955 can request service to indicate to the controller that data is ready or to warn of an error condition. In response to a serial poll after asserting SRQ, the 2955 provides a status byte whose bits are allocated as shown in Fig. 3-15.

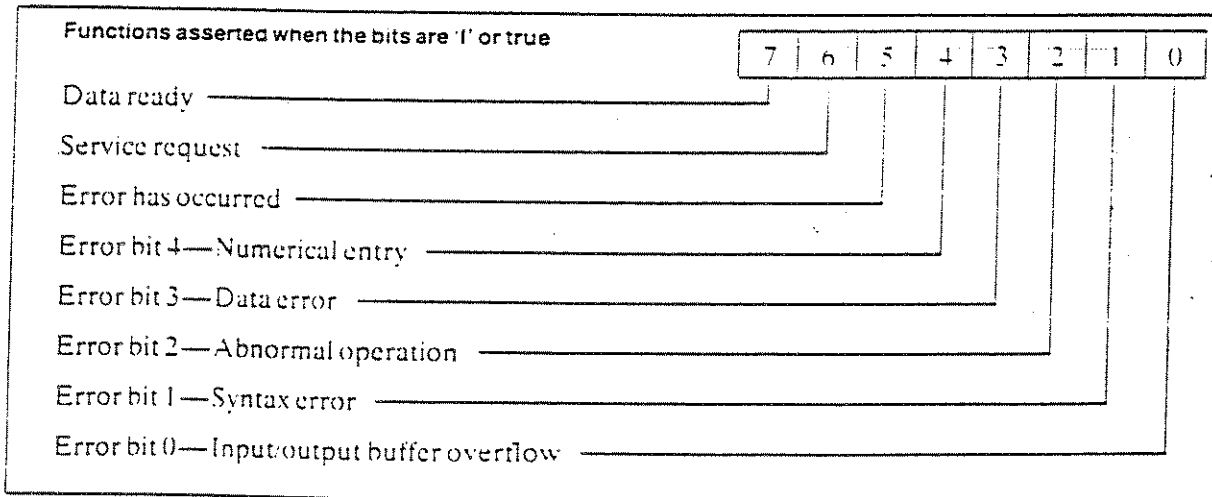

Notes...

- (1) DATA READY and ERROR bits are cleared after the next time the instrument is addressed to talk.
- (2) The SERVICE REQUEST bit is cleared after a serial poll.

CREATING A DISPLAY

The addition of the GPIB unit enables a display to be created to your own requirements. To make this as easy as possible, the instrument is programmed with a number of specialized screen commands as well as having a comprehensive character set stored in memory.

Screen commands

The operations involved in creating a display are: firstly to clear the current display; secondly to show the user-configured display with the selected measurements appearing when and where required; thirdly to return to measurement mode. The following commands are used for these purposes:-

CS—Clear Screen: This clears the screen but allows measurement results to be displayed.

DS—Disable Screen output: Stops measurements from being displayed on the screen.

ES—Enable Screen output: Enables measurement results to be written on the screen.

HD—Hold Display: Used to halt instrument operation.

RS—Restore Screen: Returns display to measurement mode.

The above commands may be used to operate the instrument in two modes: one in which the instrument is halted; and one in which the instrument is still running.

Instrument halted example:

COMMANDS

"HDICS"

"WR—"

"BX—"

"SK—"

↓

"RS"

COMMENTS

(1) Keyboard GPIB commands are ignored.

(2) Readings held are those at time of "HD".

Instrument running example:

COMMANDS

"CSDS"

"ES.WR—"<LF>"DS"

"ES.BX—DS"

↓

"RS"

COMMENTS

(1) Keyboard GPIB commands are responded to.

(2) New readings are valid and readable.

Printing on the screen

To print on the screen the BX and WR commands are used.

BX (BoX) command

This command is used to position and define the boxes (arrows) on the screen pointing to the mode keys. The command has the form BX n.m where n = box pattern and m = length of box. A display example is shown in Fig. 3-16.

Box pattern (n): The boxes appear in fixed positions on the screen against the 8 mode keys. These positions are binary coded—1 for a box, 0 for no box—and are binary weighted from top to bottom. For example, for boxes to appear next to the DUPLEX, BAR CHART and HOLD DISPLAY keys then n = binary 01010100, which (reading conventionally from right to left) = 84.

Length of box (m): This is the number of characters in the box to a maximum of 31. To produce the box to take 'PRESS WHEN READY' then m = 16 (spaces included). If boxes of different lengths are required, sequential BX commands must be sent.

Note...

The rightmost two squares are used for the point of the arrow and are not available for characters. Thus a box of length 6 to contain, e.g. RETURN will have an apparent length of 8.

To print a box of length 10 as shown in Fig. 3-16 but against the SCOPE key, the command string would be:-

BX32.10"

To clear the screen prior to the boxes being printed, add 64 to m. For the example above $m = 10 + 64 = 74$.

Since CONTINUE and RETURN are commonly used for menu displays, the facility exists to call these labels up by simply adding fixed values to m. Note that the position of each arrow is fixed, i.e. CONTINUE against the SCOPE key, and RETURN against the HOLD DISPLAY key.

CONTINUE: To call up the CONTINUE label, add 32 to m. But ensure that there is sufficient room for the word in the box, i.e. m must be at least $32 + 8 = 40$ otherwise CONTINUE will not be printed. Thus to display CONTINUE in a box of length 6 against the BAR CHART key, the command string would be "BX16.40".

RETURN: To call up the RETURN label against the HOLD DISPLAY key, add 128 to m. Ensure that m is at least $128 + 6 = 134$ otherwise RETURN will not be printed. Fig. 16 shows an example of the use of this facility.

To print inside a box, other than for CONTINUE and RETURN which appear at fixed positions, use the WR command.

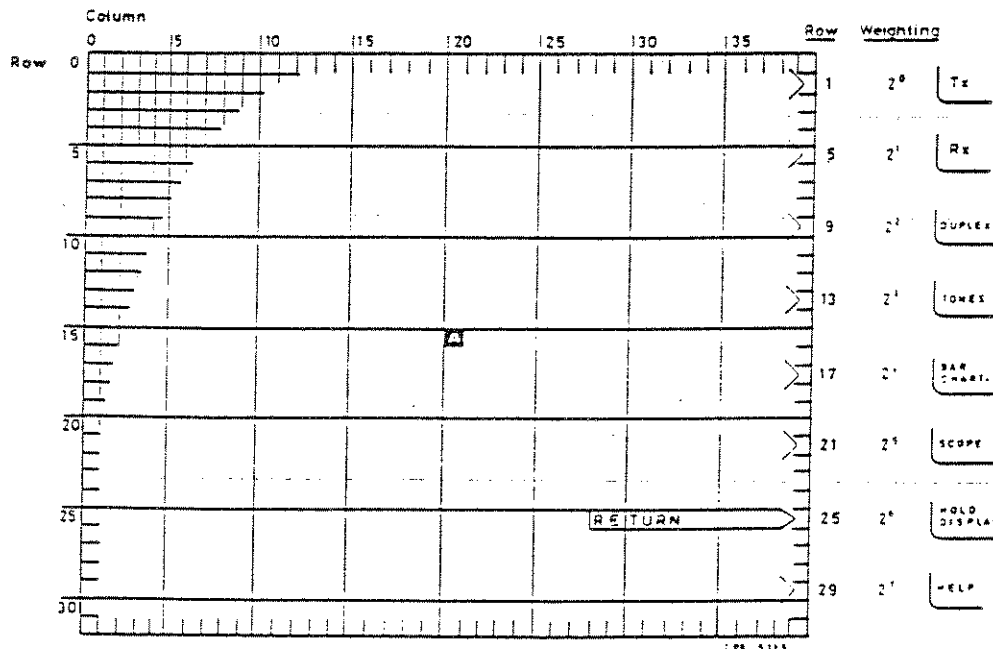

Fig. 3-16 Screen addressing example. Sending "WR20.15.a" will print the reverse field A positioned at the centre of the 40 x 32 display area. The arrowheads show the assigned positions of boxes. Sending BX64.138 will print RETURN as shown in a box of length 10 opposite the HOLD DISPLAY key.

WR (WRite) command

This command is used to write the data following the command until a delimiter is seen. The start location is c = column and r = row. For example, to print a reverse field A at the centre of the screen at column 20, row 15 as shown in Fig. 3-16 use:-

```
"WR20.15." :CHRS(97) or "WR20.15a"
```

Note that anything immediately following WRc,r is treated as a literal. Thus for multiple WR statements, end each one with <LF> or other terminator, e.g.

```
"WR20.15.a" :CHRS(10) "WR20.16.b" :CHRS(10) not "WR20.15.a.WR.20.16.b" :CHRS(10)
```

The command is also used to print a label inside a box produced using the BX command. Refer to Fig. 3-16 to find the column (variable) and the row (fixed). For example, to print RETURN as shown in Fig. 3-16 but against the SCOPE key the command string would be:-

```
"WR28.21RETURN"
```

or inside a box:-

```
"BX32.10WR28.21RETURN"
```

Character set

The complete set of characters for the instrument is shown in Fig. 3-17. These characters may be used with the WR command to print onto the screen. Note that with the principal exception of the alphanumeric—A to Z, 0 to 9—the characters are not standard ASCII. Because of this, when a lower case letter is sent (in standard ASCII) from the controller it is interpreted by the 2955 as a reverse field upper case letter.

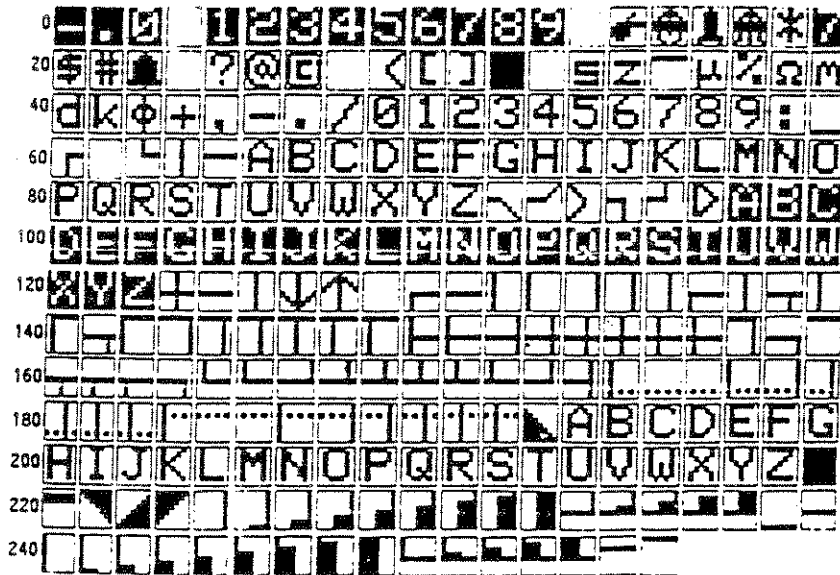

Fig. 3-17 Character set for 2955. Characters are written on the screen using the WR command. The characters shown blank are either unallocated or are machine functions, e.g. 32 is space. Note that character 10—reverse field 7—is not available. Use character 19 instead.

Reverse field characters

Many of the reverse field characters, by their structure, have an open top. For characters which have a bar at the top e.g. E.F.T this is particularly noticeable. A more pleasing appearance may be given to such a character by printing a reverse field top character (ASCII 59) directly above it. For example the reverse field E sent by:-

```
"WR10.15e"
```

is improved by adding:-

```
"WR20.14":CHRS(59)
```

Worksheet

Fig. 3-18 is provided as a worksheet for defining the screen addresses and plotting the screen layout.

Graticule characters

Some caution is required in the use of characters 128 to 191 since these are used to form the oscilloscope graticule. When the instrument recognizes a graticule character it also switches on the oscilloscope trace for the duration of that character. This may cause strange affects when these characters are used to form a user-defined display. Because of the method of triggering, no trace will be observed as long as these characters are not used in a vertical sequence (the screen is scanned from top to bottom). This means that, for instance, horizontal lines of these characters may be drawn as long as they are staggered i.e. chequerboard or alternate lines.

To detect the presence, or otherwise, of the trace in a user-defined display, check for any movement in the display while adjusting the oscilloscope POSITION controls.

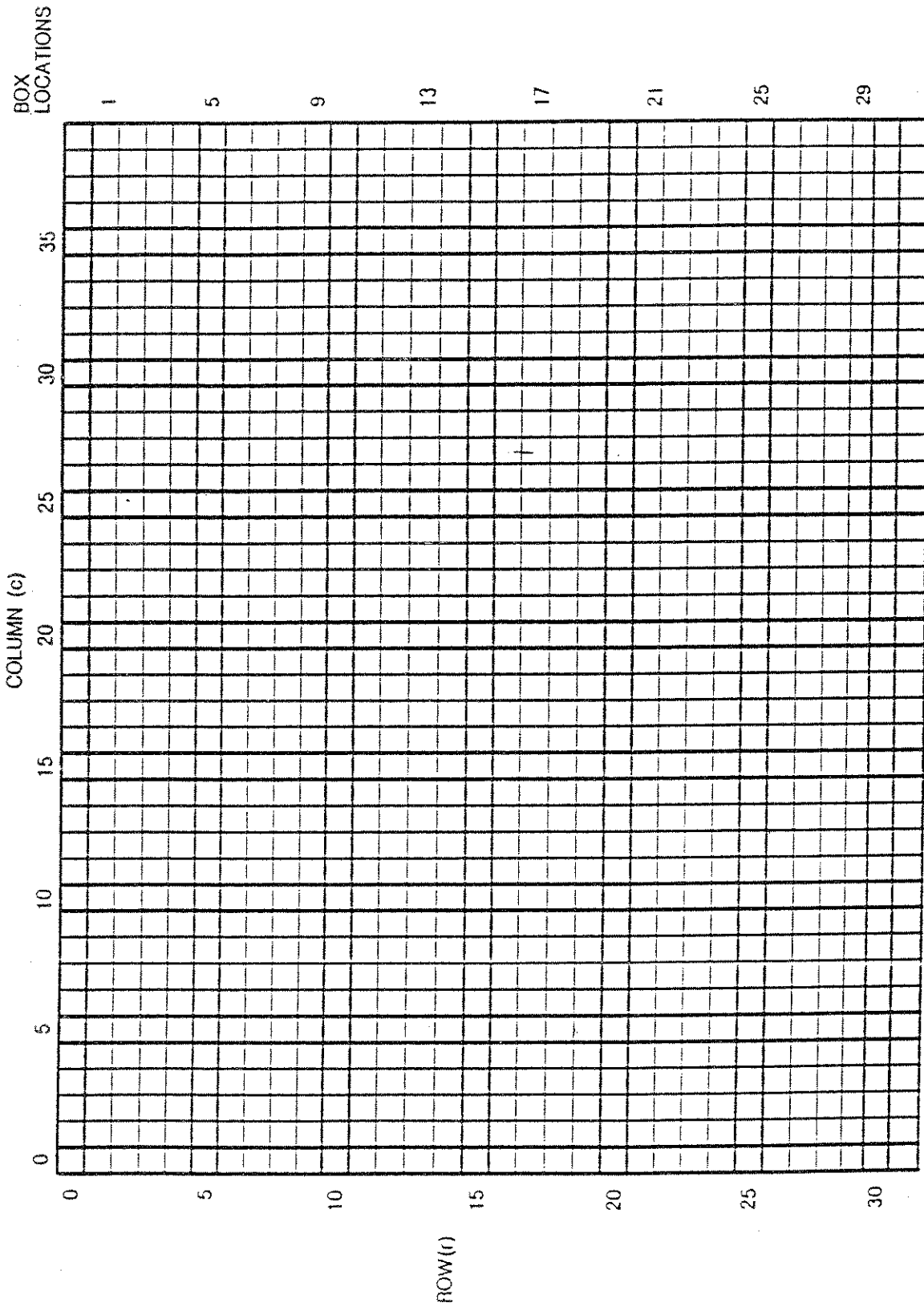

GPIB SYNTAX "WRc,r,-----"

Fig. 3-18 Screen address worksheet

Display example

A typical application of a user-created display is shown in Fig. 3-19, which features an interconnection diagram. The accompanying program was written using an HP 9816 Personal Computer.

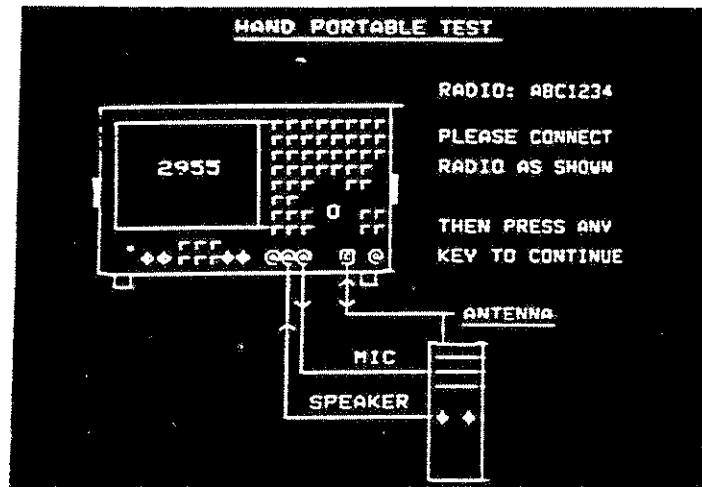

```

1000 Start:      DIM A$(100)
1010              Addr=705
1020              REMOTE Addr
1030              RESTORE Radio
1040              GOSUB Displaypage
1050              STOP
1060 Radio:      DATA 11,0,"HAND PORTABLE TEST"
1070              DATA 11,1,"*****"
1080              DATA 0,4,"              RADIO: ABC1234"
1090              DATA 0,5," 00000000000000000000"
1100              DATA 0,6," 00000000000000000000"
1110              DATA 0,7," 00000000000000000000" PLEASE CONNECT"
1120              DATA 0,8," 00000000000000000000"
1130              DATA 0,9," 00 2955 0000000000000000" RADIO AS SHOWN"
1140              DATA 0,10," 00000000000000000000"
1150              DATA 0,11," 00000000000000000000"
1160              DATA 0,12," 00000000000000000000"
1170              DATA 0,13," 00000000000000000000" THEN PRESS ANY"
1180              DATA 0,14," 00000000000000000000"
1190              DATA 0,15," 00000000000000000000" KEY TO CONTINUE"
1200              DATA 0,16," *****"
1210              DATA 0,17," *****"
1220              DATA 0,18," *****"
1230              DATA 0,19," *****"
1240              DATA 0,20," *****"
1250              DATA 0,21," *****"
1260              DATA 0,22," *****"
1270              DATA 0,23," *****"
1280              DATA 0,24," *****"
1290              DATA 0,25," *****"
1300              DATA 0,26," *****"
1310              DATA 0,27," *****"
1320              DATA 0,28," *****"
1330              DATA 0,29," *****"
1340              DATA 0,30," *****"
1350              DATA -10,0,0
1360              |
1370              |
1380              |
1390 Displaypage: OUTPUT Addr USING "*****" CLEAR SCREEN
1400              READ X,Y,P$
1410              IF X=0 THEN RETURN PAGE COMPLETE?
1420              OUTPUT Addr USING "*****"
1430              GOTO 1400
1440              |
1450              |
1460              |
1470              END
    
```

Fig. 3-19 Display example—Interconnections

PRINTER

General

Any listen only printer may be used with the 2955. A printer designed for use with the instrument is offered as an optional accessory (see 'Accessories', Chap. 1).

Power supplies

When operating with the 2955, the printer offered as an optional accessory uses the ACCESSORY socket for its power supply. For stand-alone operation, it requires a supply of ± 12 V at 2 A peak. If any other printer is used it would normally need to have its own power supply. However, the ACCESSORY socket may be used (pin 2 supplies ± 12 V at approx. 100 mA continuous), but if the low amount of power supplied must be taken into consideration.

GPIB cable

The GPIB cable is connected between the printer and the GPIB interface unit fitted at the rear of the 2955. For cables with the IEC connectors, the IEEE to IEC adapters (see 'Accessories', Chap. 1) may be used for conversion purposes.

Operation

For use as a ticket printer for printing out measurement results proceed as follows:-

- (1) Make the power supply and GPIB cable connections as given earlier.
- (2) Set TALK ONLY (switch 6 to 1) on the 2955 GPIB address switch. Set switches 1 and 2 respectively as follows:-
 - 00 = Upper and lower case, <CR> suppressed
 - 01 = Upper and lower case, <CR> not suppressed
 - 10 = Upper case only, <CR> suppressed
 - 11 = Upper case only, <CR> not suppressed

Note that in TALK ONLY mode, switches 3,4,5 are inoperative.

- (3) Switch the 2955 off then back on to enable the instrument to read the new switch settings.
- (4) Press the HOLD DISPLAY key. HOLD OFF is displayed against the SCOPE key and PRT appears against the HELP key.
- (5) Press the key arrowed by PRT. This starts the printer and results in a printout of the major settings and readings shown in the top half of the display (see example in Fig. 3-20). Note that once printout has started there is no way to abort it.
- (6) When using the ACCESSORY socket for power, the screen may be affected (sides drawn in) due to power drain, especially when printing rows of dots. This is unimportant and will not affect measurement results since these are already frozen.

```
TRANSMITTER TEST
-----
TESTING
-----
RF FREQ: 1.0000 MHz
LEVEL: 1.0000
FILTER: 0.3-3.4 kHz
-----
REQUIRE
-----
TX FREQ: 439.9995 MHz
POWER: 500mW
MOD FREQ: 1.0000 kHz
LEVEL: 0.34 kHz
DISTN: 4.30
MODEL: .....
SER #: .....
DATE: .....
```

Fig.3-20 Transmitter test printout example.

For additional printing information, refer to the appropriate printer instruction manual.

