

**SCALAR NETWORK ANALYZER
MODEL 560A
OPERATION AND MAINTENANCE
MANUAL**

WILTRON

P.O. BOX 7290 • 805 E. MIDDLEFIELD ROAD • MOUNTAIN VIEW, CA 94042-7290
TEL. (415) 969-6500 • TWX 910-379-6578

△ IDENTIFIES PORTIONS COPYRIGHT © 1979
BY TEKTRONIX, INC. ALL RIGHTS RESERVED.
REPRODUCED BY PERMISSION OF TEKTRONIX, INC.

1-560A-OMM
PRINTED: APRIL 1982
COPYRIGHT 1982 WILTRON CO

WARRANTY

All products are warranted against defects in material and workmanship for one year from the date of shipment. Our obligation covers repairing or replacing products which prove to be defective during the warranty period and which shall be returned with transportation charges prepaid to WILTRON. Obligation is limited to the original purchaser. We are not liable for consequential damages.

TABLE OF CONTENTS

<u>Section</u>		<u>Page</u>
I	GENERAL INFORMATION	
1-1	Introduction	1-1
1-2	Description of the Model 560A	1-1
1-3	Equipment Required but Not Supplied	1-1
1-4	Specifications	1-2
	1-4.1 Model 560A Scalar Network Analyzer	1-2
	1-4.2 Model 560 SWR Autotesters	1-5
	1-4.3 Model 560 RF Detectors	1-6
1-5	Accessories	1-7
1-6	Description of the Interface Bus	1-8
	1-6.1 Data Bus Description	1-8
	1-6.2 Management Bus Description	1-8
	1-6.3 Data Byte Transfer Control (Handshake) Bus Description	1-8
1-7	RF Detector-Diode Replacement Feature	1-10
II	INSTALLATION	
2-1	Introduction	2-1
2-2	Initial Inspection	2-1
2-3	Preparation for Use	2-1
	2-3.1 Selection of Operating Voltage	2-1
	2-3.2 Sweep Generator Interconnection	2-1
	2-3.3 Horizontal Sweep Ramp Normalization	2-2
2-4	GPIB Setup and Interconnection	2-4
	2-4.1 Interface Connector	2-4
	2-4.2 Cable Length Restrictions	2-5
	2-4.3 Interconnecting the Model 560A on the GPIB	2-5
	2-4.4 Addressing the Model 560A	2-5
	2-4.5 Data Delimiting (CR-CR/LF Switch)	2-6
2-5	Preparation for Storage and/or Shipment	2-6
	2-5.1 Preparation for Storage	2-6
	2-5.2 Preparation for Shipment	2-6
III	OPERATION	
3-1	Introduction	3-1
3-2	Controls and Connectors	3-1
	3-2.1 Front Panel Controls and Connectors	3-1
	3-2.2 Rear Panel Controls and Connectors	3-4
	3-2.3 Side Panel Controls	3-6

TABLE OF CONTENTS (Continued)

<u>Section</u>	<u>Page</u>
III OPERATION (Continued)	
3-3	Using Front Panel Controls 3-6
3-3.1	Input Controls 3-6
3-3.2	Memory Controls 3-7
3-3.3	Vertical Scale Factor Controls 3-16
3-3.4	Marker Controls 3-20
3-3.5	Display Mode Controls 3-20
3-3.6	Smoothing Controls 3-21
3-4	Operational Checkout 3-25
3-4.1	Preliminary Checks 3-25
3-4.2	Operational Checkout and Troubleshooting Procedure 3-25
3-4.3	CRT Mainframe HORIZ POSITION and TRACE ROTATE Adjustment Instructions 3-42
3-5	Low Level (<-45 dBm) Trim Adjustments 3-43
3-6	560-10BX(-1) CABLE 3-46
3-7	GPIB Operation (Option 3) 3-47
3-7.1	General Information and Description of Model 560A GPIB Command Codes 3-47
3-7.2	Summary of GPIB Command Codes 3-54
3-7.3	Data Output Format 3-54
3-7.4	Sample Program in HPL Computer Language for HP 9825A Programmable Calculator 3-54
3-7.5	Sample Program in BASIC Computer Language for Commodore PET 2001 Controller 3-54
3-7.6	Sample Program in BASIC Computer Language for HP 85 Controller 3-54
3-8	Alternate-Sweep Operation 3-60
IV PERFORMANCE VERIFICATION	
4-1	Introduction 4-1
4-2	Recommended Test Equipment 4-1
4-3	Performance Verification 4-1
4-3.1	Performance Verification Philosophy 4-1
4-3.2	Performance Verification Procedure 4-1
4-3.3	Performance Verification Procedure (Option 3-GPIB) 4-13
4-4	Power Accuracy Measurement Chart 4-16
4-4.1	Error Sources Inherent In Performance Verification Procedure Power Measurement Chart 4-16
4-4.2	Recommended Courses of Action For Power Accuracy Out of Tolerance Conditions 4-17
4-5	Power Accuracy Test Using DC Voltage Standard 4-18

TABLE OF CONTENTS (Continued)

<u>Section</u>		<u>Page</u>
V CALIBRATION		
5-1	Introduction	5-1
5-2	Gaining Access to the 560A Printed Circuit Boards	5-1
5-3	Front Panel (A1) and Digital (A2) PCB Adjustments	5-2
5-3.1	Power Supply Checks and OFFSET dB Display Reference Voltage Check and Adjustment	5-3
5-3.2	Horizontal Clamp and CRT Mainframe HORIZ POSITION and X-Gain Adjustments	5-4
5-3.3	Refresh Horizontal Gain Adjustments (Including X-Y Plot).	5-5
5-3.4	Channel A and Channel B OFFSET ZERO Adjustments.	5-6
5-3.5	CRT Mainframe Vertical Calibration	5-7
5-3.6	Storage Memory Digital-to-Analog Converter Calibration	5-8
5-3.7	Vertical Analog-to-Digital Converter Calibration	5-10
5-3.8	Channel A and Channel B Memory and Subtract Balance Adjustments	5-13
5-3.9	Refresh Digital-to-Analog Converter Calibration and Dot Connector Adjustments	5-15
5-4	Log Amplifier (A3) PCB Adjustments	5-17
5-4.1	Channels A, B, A&B, and R Power Supply, Offset, Reference, and Thermistor Voltage Checks and Adjustments	5-17
5-4.2	Channels A&B Detector Balance Adjustments	5-20
5-4.3	Channels A&B and R Log Amplifier Accuracy Adjustments.	5-21
5-5	GPIO Interface (A6) PCB Adjustments	5-26
VI PARTS LIST		
6-1	Introduction.	6-1
6-2	Parts Ordering Information	6-1
6-3	Abbreviations.	6-1
6-4	Replaceable Parts - Network Analyzer Section	6-1
6-5	Replaceable Electrical Parts - CRT Mainframe	6-18
6-5.1	Parts Ordering Information	6-18
6-5.2	List of Assemblies	6-18
6-5.3	Cross-Index - Mfr. Code Number to Manufacturer	6-18
6-5.4	Abbreviations.	6-18
6-5.5	Component Number (Column 1 of Table 6-10)	6-18
6-5.6	Tektronix Part No. (Column 2 of Table 6-10)	6-18
6-5.7	Name and Description (Column 3 of Table 6-10)	6-18
6-5.8	Mfr. Code (Column 4 of Table 6-10).	6-19

TABLE OF CONTENTS (Continued)

<u>Section</u>		<u>Page</u>
VI	PARTS LIST (Continued)	
	6-5.9 Mfr. Part Number (Column 5 of Table 6-10)	6-19
	6-5.10 WILTRON Part Number (Column 6 of Table 6-10)	6-19
6-6	Replaceable Mechanical Parts - CRT Mainframe	6-27
	6-6.1 Parts Ordering Information.	6-27
	6-6.2 Figure and Index Numbers	6-27
	6-6.3 Indentation System	6-27
	6-6.4 Abbreviations	6-28
	6-6.5 Cross-Index - Mfr. Code Number to Manufacturer	6-28
VII	SERVICE	
7-1	Introduction	7-1
7-2	General Information	7-1
	7-2.1 Printed Circuit Board Exchange Program	7-1
	7-2.2 Recommended Test Equipment	7-1
7-3	Troubleshooting.	7-1
	7-3.1 Gaining Access to Network Analyzer and CRT Mainframe Printed Circuit Boards	7-1
	7-3.2 Troubleshooting Flow Charts	7-1
7-4	Service Instructions	7-12
7-5	Microwave Components.	7-15
	7-5.1 SWR Autotester	7-15
	7-5.2 Model 560-7 Series RF Detectors	7-15
	7-5.3 Model 560-71 Series RF Detectors	7-15
	7-5.4 Diode Replacement, 560-6 Series SWR Autotesters	7-15
	7-5.5 Diode Replacement, 560-7 Series RF Detectors	7-16
	7-5.6 Diode Replacement, 560-71 Series RF Detectors	7-18
	7-5.7 WSMA Connector Center-Pin Replacement.	7-19
	7-5.8 Connector Cleaning	7-19
7-6	Log Amplifier (A3) Printed Circuit Board.	7-19
	7-6.1 R Channel Log Amplifier	7-28
	7-6.2 A10 Input Module Assembly.	7-34
	7-6.3 Channel A Local Isolated-Ground Driver and +/- 15 V Regulator Circuits	7-36

TABLE OF CONTENTS (Continued)

<u>Section</u>	<u>Page</u>
VII	SERVICE (Continued)
7-6.4	Channel A Temperature and Offset Bridge Circuits 7-36
7-6.5	Cross-Channel and Chassis Common- Mode Signal-Rejection Circuits 7-37
7-6.6	Channel B Local Isolated-Ground Driver and +/- 15 V Regulator Circuits 7-41
7-6.7	Channel B Temperature and Offset Bridge Circuits 7-41
7-6.8	Channel A&B Switched Isolated-Ground Driver and +/- 15 Volt Regulator Circuits 7-41
7-6.9	Autozero Circuit 7-42
7-6.10	Channel A&B 3-Stage Linear Amplifier and Smoothing Circuit. 7-43
7-6.11	Channel A&B 12-Section Log Shaper Circuit. 7-47
7-6.12	Channel A&B Temperature Separator and Log Shaper Bias Circuits 7-47
7-6.13	Channel A&B dBm Normalizer, Common- Mode Subtractor, Test Summer, and -R Summer and Inverter Circuits 7-47
7-6.14	Channel A&B Demultiplexer, Switch- Reference, Autozero, and Smoothing Logic Circuits. 7-48
7-6.15	Input Module Voltage Translator Circuit. 7-55
7-7	Front Panel (A1) and Digital (A2) Printed Circuit Boards. 7-56
7-7.1	Front Panel PCB Circuits 7-69
7-7.2	Vertical Signal Multiplexing, Hold-During- Bandswitch/Retrace, and Hold-During- Conversion Circuits. 7-73
7-7.3	REFERENCE dBm Indicator Flash Circuit. 7-73
7-7.4	Horizontal and Vertical A/D Converter Circuits 7-77
7-7.5	Storage Memory and Memory D/A Circuits 7-78
7-7.6	Sensitivity Storage Circuits. 7-81
7-7.7	Refresh Address Control Circuits 7-82
7-7.8	Refresh Vertical Memory, Marker Refresh Memory, and Dot Connector D/A Circuits. 7-87
7-7.9	Refresh Ramp Generator Circuit. 7-88
7-7.10	Vertical Output Circuits 7-90
7-7.11	Marker Input, Marker Output, and Seq Sync Normalizer Circuits 7-91
7-7.12	Channel A/B Alternating Sweep Circuit 7-95
7-7.13	Smoothing Sequencer, Smoothing Local/Remote Multiplexer, and Smoothing Indicator LED Circuits 7-96
7-7.14	Blanking Normalizer Circuit 7-97

TABLE OF CONTENTS (Continued)

<u>Section</u>	<u>Page</u>
VII	SERVICE (Continued)
7-7.15	Reduce Sweep Speed Circuit 7-97
7-7.16	Log Amplifier Autozeroing Pulse Generator, Log Amplifier Reference-Switch Pulse Generator, and Local/Remote Multiplexer Circuits 7-97
7-7.17	System and Output Counter Clock Circuit 7-99
7-7.18	Store Trace A (STA) and Store Trace B (STB) Circuits 7-99
7-7.19	Refresh Write Enable Control Circuit 7-101
7-7.20	Refresh-Real Time Channel A/B Alternating Sweep, Pen-Lift Relay, CRT Blank, and X-Y Plot Multiplexer Circuit 7-101
7-7.21	Remote-Local Channel Select Multiplexer Circuit. 7-101
7-7.22	Real Time and Refresh X-Y Plot Control Circuit. 7-105
7-7.23	Power-On Reset Circuit 7-108
7-7.24	Detailed Block Diagram of the A1/A2 PCBs 7-113
7-8	GPIB Interface (A6) Printed Circuit Board 7-113
7-8.1	GPIB Transceiver Integrated Circuits 7-124
7-8.2	Address Recognition Circuit 7-124
7-8.3	Listen Function Circuit. 7-127
7-8.4	Acceptor (Listener) Handshake Circuit. 7-127
7-8.5	DDM Strobe Generator Circuit 7-128
7-8.6	Remote Function Circuit 7-128
7-8.7	Talk Function Circuit. 7-129
7-8.8	Source (Talk) Handshake Circuit 7-129
7-8.9	SRQ Generator Circuit 7-131
7-8.10	Command Decoder Circuit 7-134
7-8.11	Power-On Reset Circuit 7-137
7-8.12	Channel Select Circuit 7-141
7-8.13	Calibrate (Autozero) Timing Circuit 7-141
7-8.14	Smoothing (Filter) Control Circuit 7-142
7-8.15	X-Y Plot Trigger Circuit. 7-142
7-8.16	Input Selector Circuit. 7-143
7-8.17	Settling Time Determination Circuit 7-143
7-8.18	A/D Converter Input Circuits. 7-144
7-8.19	A/D Converter Conversion Circuits 7-146
7-8.20	Byte Sequencer Circuit 7-151
7-9	GPIB Connector Panel (A7) Printed Circuit Board 7-152
7-10	Power Supply (A4) Printed Circuit Board 7-155
7-11	Interface Control (A8) Printed Circuit Board 7-156
7-11.1	Z-Axis Blanking 7-160
7-11.2	Internal Retrace Blanking 7-160

TABLE OF CONTENTS (Continued)

<u>Section</u>		<u>Page</u>
VII	SERVICE (Continued)	
	7-11.3 Alternate-Sweep Capability	7-161
7-12	A9 Rear Panel Assembly	7-165
	7-12.1 Rear Panel Switches	7-165
	7-12.2 Rear Panel Connectors	7-165
7-13	CRT Mainframe	7-166
	7-13.1 Block Diagram	7-166
	7-13.2 Deflection Amplifiers	7-168
	7-13.3 Z-Axis Amplifier.	7-169
	7-13.4 High-Voltage Power Supply	7-170
	7-13.5 Low-Voltage Power Supply	7-172
	7-13.6 CRT Mainframe X, Y, Z and +20 Volt Input Connections	7-173
	7-13.7 Parts Locator Diagrams	7-173
7-14	Disassembly/Reassembly Instructions	7-181
	7-14.1 Disassembly/Reassembly Instructions For Separating CRT Mainframe From Network Analyzer Section	7-181
	7-14.2 Disassembly/Reassembly Instructions For Network Analyzer Section Front Panel Assembly.	7-185

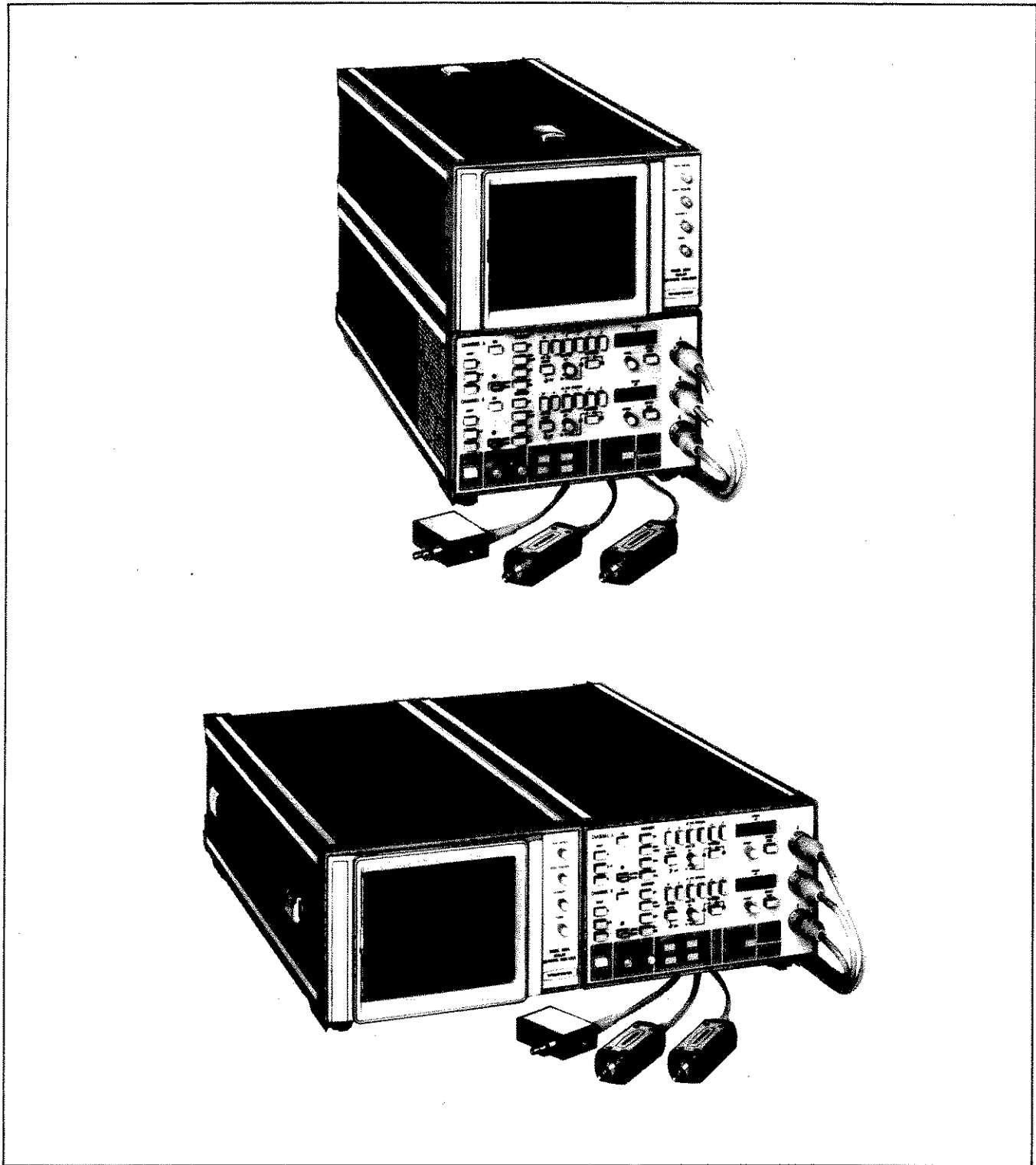

Figure 1-1. Top: Model 560A Scalar Network Analyzer Option 2 Vertical Configuration. Bottom: Model 560A Horizontal Configuration. (Components shown are ordered as separate items. See paragraph 1-2.)

SECTION I

GENERAL INFORMATION

1-1 INTRODUCTION

This manual describes the Model 560A Scalar Network Analyzer and Model 560 series microwave components. The manual is organized as follows:

SECTION I, GENERAL INFORMATION, provides a general description and specifications for the network analyzer; 560-97, -98, and -6 series SWR Autotesters; and 560-7 and 560-71 series RF detectors. Also included is a description of the IEEE-488 (IEC 625) General Purpose Interface Bus (GPIB).

SECTION II, INSTALLATION, contains initial inspection, preparation for use, and GPIB interconnection data. This section also includes information on shipment and storage of the network analyzer and its dedicated microwave components.

SECTION III, OPERATION, provides information on the controls and connectors, and on the Option 3 GPIB capability. This section also provides checkout and troubleshooting data using front panel controls.

SECTION IV, PERFORMANCE VERIFICATION, contains performance verification philosophy and procedures for the 560A, including the Option 3 GPIB circuits (A6 printed circuit board).

SECTION V, CALIBRATION, provides adjustment instructions for the Front Panel (A1), Digital (A2), Log Amplifier (A3), and Optional GPIB Interface (A6), printed circuit boards.

SECTION VI, PARTS LISTS, contains listings of replaceable electrical and mechanical parts for the 560A, including

the CRT mainframe and Option 3 GPIB Interface (A6) printed circuit board.

SECTION VII, SERVICE, provides service instructions for the 560A, including CRT mainframe and Option 3 GPIB Interface (A6) printed circuit board. This section contains troubleshooting charts; disassembly instructions; circuit descriptions; and schematic, block and timing diagrams.

1-2 DESCRIPTION OF THE MODEL 560A SYSTEM

The Model 560A Scalar Network Analyzer system measures return loss, insertion loss, gain, and absolute power over a broad frequency range. The system (Figure 1-1) is composed of a network analyzer and one, two, or three microwave components. These microwave components (depending upon application) may consist of either an SWR Autotester, an RF detector, or a combination of the two. The Model 560A Scalar Network Analyzer is described in paragraph 1-4.1, and the two models of SWR Autotesters (560-97, -98, and -6 series) and two models of RF detectors (560-7 and 560-71 series) are described in paragraphs 1-4.2 and 1-4.3, respectively.

1-3 EQUIPMENT REQUIRED BUT NOT SUPPLIED

The Model 560A Scalar Network Analyzer system requires interconnection with a sweep generator to provide the necessary vertical, horizontal, and blanking voltages (Table 1-1). While the 560A is designed for use with the WILTRON 6600(A) Series Programmable Sweep Generator, it is also compatible with other sweep generators.

1-4 SPECIFICATIONS

The following paragraphs provide a description and specifications for the 560A Scalar Network Analyzer; 560-97, -98, and -6 series SWR Autotesters; and 560-7 and -71 series RF detectors.

1-4.1 Model 560A Scalar Network Analyzer

The Model 560A Scalar Network Analyzer is a GPIB-compatible, three-channel microwave measurement instrument. The three channels consist of two measurement channels (A, B) and one reference channel (R), which allow the network analyzer to

simultaneously display the results of two measurements. The 560A also contains internal memory circuits that provide two different functions – measurement-normalization memory and display-refresh memory. The measurement-normalization memory stores transmission measurement system residuals and return loss calibration data. The display-refresh memory provides a non-flickering display, regardless of sweep generator sweep speed. The refresh memory also provides for a slow, 30-second sweep for an external X-Y plotter.

A complete listing of the 560A specifications is contained in Table 1-1.

Table 1-1. Model 560A Scalar Network Analyzer Specification Chart

FREQUENCY RANGE: See SWR Autotester and RF detector specifications, Table 1-2 and Table 1-3, respectively.

CHANNELS: Three (A, B, R) with pushbutton selection of A, B, R, A-R and B-R. Detected input signals supplied by detectors or SWR Autotester, which may be interchanged without adjustment. Two channels are displayed simultaneously.

DYNAMIC MEASUREMENT RANGE AND SENSITIVITY:

A and B with Detectors:*
66 dB (+16 dBm to -50 dBm)
A and B with SWR Autotester:
60 dB (+10 dBm to -50 dBm)**
R with Detector:*
46 dB (+16 dBm to -30 dBm)

*With 75Ω detectors, maximum output is +13 dBm.

**As seen by internal detector, typically 13 dB below input power with 0 dB return loss at test port.

OFFSET CONTROL: Positioning of A and B traces is independently and continuously adjustable over $> \pm 65$ dB range. When trace is on reference line, power is displayed in dBm on 3-digit LED readout with 0.1 resolution. Offset is displayed in dB relative to a 0 dB reference level or in dBm relative to a 0 dBm reference level.

ZERO dB REFERENCE SET: Positions reference trace at selected 0 dB reference line.

REFERENCE POSITION LOCATOR: Displays reference trace to locate reference line. Position of reference line screwdriver-adjusted.

OFFSET ZERO POSITION: Moves trace to the position it would have if OFFSET were adjusted to 0 dB.

RESOLUTION: Independent control for A and B in steps of 0.2, 0.5, 1, 2, 5, 10 dB per division. Other values (3, 6, 15 dB, etc.) obtained by depressing multiple pushbuttons.

MEMORY:

STORE TRACE: Stores displayed trace(s) in 1024-point memory. Used to store system residuals and the average of open/short reflections for subtraction from input test data.

AVERAGE: Averages data in memory with input test data and displays the result. Used to average system open/short return loss characteristics for subtraction from input test data.

SUBTRACTION: Subtracts data in memory from input test data and displays result.

RECALL: Displays stored data.

UNCALIBRATED SWEEP INDICATOR: Lights when external sweep generator sweep rate is too fast for memory.

DISPLAY MODES:

REAL TIME: Horizontal sweep is synchronized with ramp from external sweep generator.

REFRESH: External sweep generator ramp is digitized and stored in 1024-point memory (512 points for dual trace). Stored data is updated continuously at sweep generator sweep rate. Steady, nonflickering display is provided regardless of sweep generator sweep rate. Vertical resolution is 512 points for single or dual traces.

REFRESH HOLD: Updating of display data is stopped. Display is frozen.

X-Y PLOT (REAL TIME): Provides pen lift, vertical, and horizontal signals for X-Y plot. Dual traces are automatically recorded by sweeping A and B channels sequentially.

X-Y PLOT (REFRESH): Display is frozen and then plotted at 30-second sweep rate. Dual traces are automatically recorded by sweeping A and B channels sequentially. After 1 second, sweep may be aborted and returned to start.

SMOOTHING FILTERS: Three levels of filtering optimize low-level signal displays.

Table 1-1. Model 560A Scalar Network Analyzer Specification Chart (continued)

MARKERS: Threshold and tilt control of externally-applied birdie or video markers.

ACCURACY

A AND B CHANNEL ACCURACY:

± 0.2 dB at +10 dBm; decreasing ± 0.1 dB/10 dBm to -40 dBm and ± 0.3 dB to -50 dBm (see graph below).

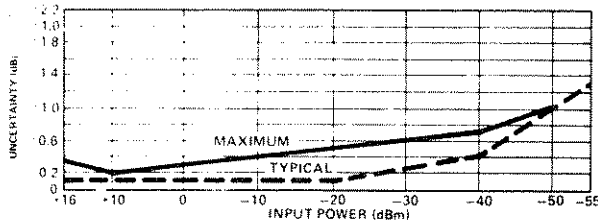

OVERALL RETURN LOSS MEASUREMENT ACCURACY:

Uncertainties resulting from SWR Autotester and sweep generator frequency response and system open/short characteristics are subtracted automatically from test data. Overall accuracy is then:

$$\text{SWR Autotester Accuracy (Table 1-2)} + \text{A and B Channel Accuracy (above)}$$

OVERALL TRANSMISSION LOSS/GAIN MEASUREMENT ACCURACY: Uncertainties resulting from frequency response of detectors, SWR Autotester, sweep generator and other test system components are subtracted automatically from test data. Overall accuracy is then:

$$\text{A and B Channel Accuracy}^*$$

* Effects of sweep generator, test device, and detector mismatch may be significant. Mismatch errors are either minimized by the exceptional low reflection characteristics of the 560 detectors (see detector return loss specifications) or padded by the insertion loss of the SWR Autotester (paragraph 1-4.2).

RATIO MEASUREMENT ACCURACY (A-R, B-R):

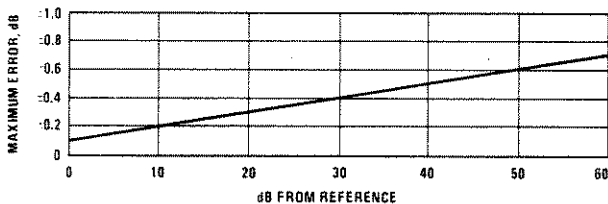

Above curve includes all log amplifier uncertainties. Errors due to Detector Mismatch variations must be accounted for separately. The use of memory eliminates errors due to detector frequency variations.

OVERALL ABSOLUTE POWER MEASUREMENT ACCURACY:

Absolute power measurement accuracy is determined by the frequency response accuracy of the detector and the absolute

accuracy of the log amplifier. Absolute power accuracy is then:
 Detector Frequency Response Accuracy (Table 1-3)
 +
 A and B Channel Accuracy (above)

CRT DISPLAY

CATHODE RAY TUBE (CRT): 8 vertical by 10 horizontal divisions. One division = 1.22 cm. Single beam, standard persistence (P31) phosphor CRT with internal graticule.

CRT BEAM CONTROLS: Intensity, Focus, Trace Rotation, and Horizontal Position.

CAMERA: Compatible with Tektronix C5A, B, or C model camera.

HOOD: Compatible with Tektronix 016-0260-00 Hood.

INPUT CONNECTIONS

HORIZONTAL INPUT: HORIZONTAL SELECT switch selects one of three types of sweep ramp inputs at rear panel
HORIZONTAL INPUT connector: 0 to +10V, 0 to +15V, and -8 to +8V. BNC connector, 100k ohms input impedance.

MARKER INPUT: 1mV to 10V peak input, rear panel BNC connector, 100k ohms input impedance. In addition, a -3V to -10V input to Z AXIS rear panel connector provides markers.

Z AXIS INPUT: +3 to +10V blanks and maintains trace amplitude during switching of sweep generator oscillators. -3V to -10V introduces markers which are controlled by THRESHOLD and TILT. Rear panel BNC connector, 10k ohms input impedance.

OUTPUT CONNECTIONS

RECORDER/CRT MONITOR CONTROL: Rear Panel OUTPUT MODE switch selects appropriate horizontal, vertical, blanking, and pen lift output voltages for external CRT monitor or mechanical recorder.

HORIZONTAL SWEEP RAMP OUTPUT: 0 to 10V in synchronism with sweep display. Rear panel BNC connector.

VERTICAL OUTPUT: Varies from 0 to $\pm 8V$ (1V/div.) in proportion to display trace position. When OUTPUT MODE switch is in CRT position, voltage alternates between A and B. When the switch is in RCDR position and an X-Y plot is initiated, voltage first varies in proportion to A over full swept range and then in proportion to B. Pen-lift voltage lifts recorder pen between sweeps. Rear panel BNC connector.

BLANK/PEN LIFT OUTPUT: Provides either CRT

Table 1-1. Model 560A Scalar Network Analyzer Specification Chart (continued)

blanking output or pen lift control signal, depending upon the position of the OUTPUT MODE switch. In the CRT mode, the positive TTL-compatible voltage is HIGH during retrace and LOW during forward sweep. In the RCDR mode, the pen lift relay contacts are normally-open during retrace. Lifted pen is held off paper until new sweep is started. Internal jumper is available for normally-closed contacts. Rear panel BNC connector.

ALTERNATING SWEEP INPUT/OUTPUT

AUX I/O: Provides interconnection between compatible sweep generators, such as the WILTRON 6600A Series Programmable Sweep Generator, and the 560A. Eliminates rear panel BNC connections between the compatible sweep generator and the 560A.

GPIB

DIGITAL INTERFACE: Conforms to IEEE 488 and IEC 625 standard digital interface for programmable instrumentation. Function subsets implemented: SH1, AH1, T6, TE0, L4, LE0, SR1, RL2, PP0, DC1, and DT0.

GPIB ADDRESS: TALK and LISTEN addresses selected by rear panel switches.

DATA DELIMITER: Rear panel switch selects either CARRIAGE RETURN (CR) or CARRIAGE RETURN and LINE FEED (CR/LF) as data delimiters when in the TALK mode.

SRQ: Instrument can be programmed to generate a service

request (SRQ) when data is available. If SRQ implementation is not desired, handshake will be completed when data is available.

REMOTE INDICATOR: Lights when test set is operating on GPIB.

PHYSICAL

TEMPERATURE RANGE:

Operating: 0°C to +50°C

Storage: -40°C to +70°C

POWER: 100V/120V/220V/240V +5%, -10% selectable on rear panel. 50 Hz to 400 Hz, 85VA maximum.

WEIGHT:

560A Horizontal or 560A Option 2

Vertical Configuration: 11kg (24.5 lb)

560A Option 1

Rack Mounting: 13.5 kg (30 lb)

SIZE:

560A Horizontal Configuration

133 mm H x 429 mm W x 500 mm D (5.26 x 16.9 x 19.7 in)

560A Option 2 Vertical Configuration

267 mm H x 213 mm W x 500 mm D (10.5 x 8.4 x 19.7 in)

560A Option 1 Rack Mount

133 mm H x 483 mm W x 500 mm D (5.25 x 19 x 19.7 in)

RACK MOUNTING (OPTION 1):

Units supplied with mounting ears and chassis track slides (90° tilt) installed.

1-4.2 Model 560 SWR Autotesters

The Model 560-97, -98, and -6 series SWR Autotesters are broadband, high-directivity reflection bridges with a built-in detector and a low-reflection test port. These SWR Autotesters are specifically designed to be compatible with all three channels of the 560A Scalar Network Analyzer. These 560 Model SWR Autotesters are well suited to making very accurate return loss (SWR) measurements.

With their typical 6.5 dB insertion loss, these components provide a pad between the source and the device under test. Padding of the sweep generator output results in a more accurate transmission loss/gain measurement because it reduces the effect of the impedance mismatch at the source.

A listing of the Model 560-97, -98, and -6 series SWR Autotester specifications is presented in Table 1-2.

Table 1-2. SWR Autotester Specifications

MODEL	TEST PORT CONNECTOR	DIRECTIVITY	ACCURACY ^①			INPUT Z	FREQUENCY SENSITIVITY	PHYSICAL
			10 MHz to 8 GHz	8 GHz to 18 GHz	18 GHz to 26.5 GHz			
560-97A50	GPC-7	36 dB	0.016 ±0.06ρ ²	0.016 ±0.1ρ ²	N/A	50Ω	±2.0 dB (Max.)	Length: 7.6 cm (3 in.) Width: 5 cm (2 in.) Depth: 2.8 cm (1-1/8 in.) Weight: 425 g (15 oz.)
Option 1		40 dB	0.01 ±0.06ρ ²	0.01 ±0.1ρ ²	N/A			
560-97S50 560-97SF50	WSMA Male Female	35 dB	0.018 ±0.08ρ ²	0.018 ±0.12ρ ²	N/A			
560-97S50 Option 1 560-97SF50 Option 1	WSMA Male Female	38 dB	0.013 ±0.02ρ ²	0.013 ±0.12ρ ²	N/A			
560-97N50 560-97NF50	Type N Male Female	35 dB 38 dB	0.018 ±0.08ρ ² 0.013 ±0.08ρ ²	0.018 ±0.12ρ ² 0.018 ±0.12ρ ²	N/A N/A			
560-98S50	Male	35 dB (01-18 GHz)	0.018 ±0.1ρ ²	0.018 ±0.1ρ ²	0.025 ±0.12ρ ²	50Ω	±1.0 dB	Length: 5.3 cm (2-3/32 in.) Width: 3.7 cm (1-15/32 in.) Depth: 1.2 cm (15/32 in.) Weight: 198 g (7 oz.)
560-98SF50	Female	32 dB (18-26.5 GHz)					±2.0 dB	
Option 1		38 dB (.01-18 GHz)					±1.0 dB	
		35 dB (18-26.5 GHz)					±2.0 dB	
560-6N50 560-6NF50	Type N Male Female	40 dB	1 MHz to 2000 MHz			50Ω	±1.0 dB (Max.)	Length: 3.8 cm (1-1/2 in.) Width: 2.9 cm (1-5/32 in.) Depth: 3 cm (1-3/16 in.) Weight: 227 g (8 oz.)
560-6N75 ^② 560-6NF75 ^②	Type N Male Female	40 dB	0.01 ±0.06ρ ²			75Ω		
All Models								
Insertion Loss: 6.5 dB ^③ nominal; Cable Length: 122 cm (4 ft.); Maximum Input Power: 27 dBm; Input Connector: N Female								

^① Where ρ is measured reflection coefficient of test device. Accuracy includes effects of test port reflections and directivity.

^② 75 ohm impedance.

^③ From RF input port to test port.

1-4.3 Model 560 RF Detectors

The Model 560-7 and 560-71 series RF detectors are specifically designed to be used interchangeably between Channel A, B, or R without need for adjustment. Both detector models are equipped with a specially-designed zero-bias Schottky diode that provides -50 dBm sensitivity. In the 560-7

series detectors, this diode is encased in a field-replaceable module; in the 560-71 series detectors this diode is a discrete component, and is also field-replaceable.

A listing of the 560-7 and 560-71 series RF detector specifications is provided in Table 1-3.

Table 1-3. RF Detector Specifications

Model 560-	Input Connector	Input Z	Frequency
7A50 7N50	GPC-7 Type N Male	50Ω 50Ω	10 MHz to 18.5 GHz 10 MHz to 18.5 GHz
7S50, Option 1 7S50, Option 2 7S50, Option 3	WSMA Male WSMA Male WSMA Male	50Ω 50Ω 50Ω	10 MHz to 18.5 GHz 10 MHz to 26.5 GHz 10 MHz to 34.0 GHz
71N50 71N75	Type N Male Type N Male	50Ω 75Ω	1.0 MHz to 2.0 GHz 1.0 MHz to 2.0 GHz

All Models

Maximum Input Power: 20 dBm (100 mW)
 Cable Length: 122 cm (4 ft)
 Dimensions: 7.6 x 2.9 x 2.2 cm (3 x 1-1/8 x 7/8 in.)
 Weight: 170 grams (6 oz.)

560-7 Series

FREQUENCY RESPONSE:

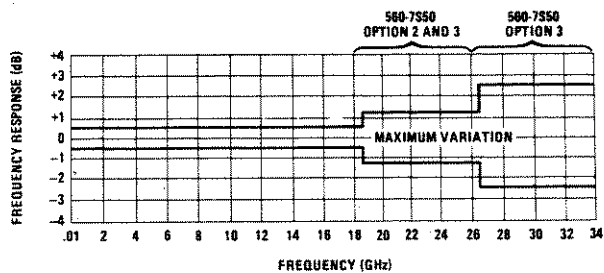

DETECTOR RETURN LOSS:

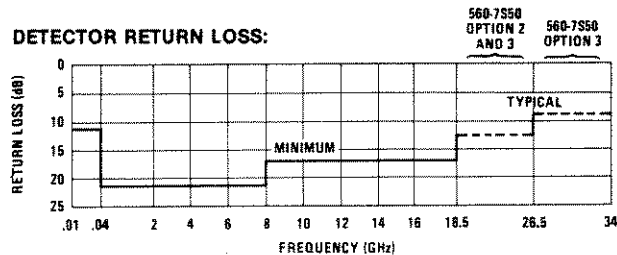

560-71 Series

FREQUENCY RESPONSE:

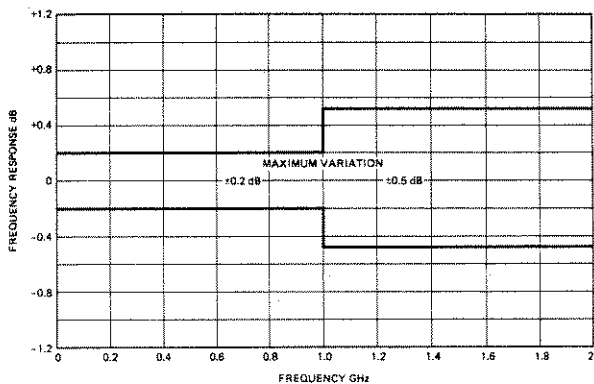

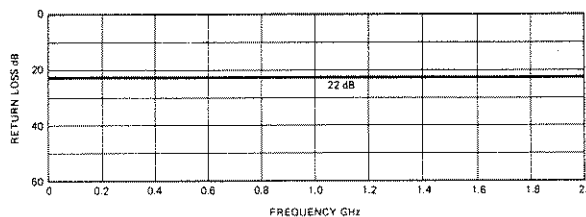

DETECTOR RETURN LOSS:



1-5 ACCESSORIES

Table 1-4 lists accessories used with the 560A Scalar Network Analyzer.

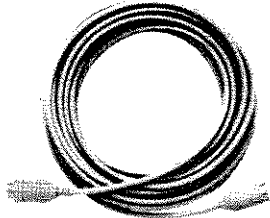
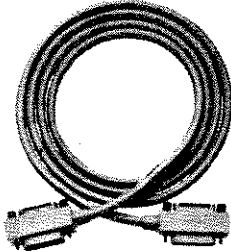
Table 1-4. Listing of Accessories

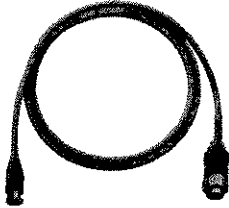
	<p>EXTENDER CABLES:</p>												
	<p>DESCRIPTION: Extender cables may be installed between SWR Autotesters or Detectors and the 560A, permitting measurements from up to 200 feet distance.</p>												
	<table border="1"> <thead> <tr> <th>CABLE LENGTH</th> <th>MODEL</th> </tr> </thead> <tbody> <tr> <td>7.6 m (25 ft)</td> <td>800-109</td> </tr> <tr> <td>15.2 m (50 ft)</td> <td>800-110</td> </tr> <tr> <td>30.5 m (100 ft)</td> <td>800-111</td> </tr> <tr> <td>61 m (200 ft)</td> <td>800-112</td> </tr> </tbody> </table>	CABLE LENGTH	MODEL	7.6 m (25 ft)	800-109	15.2 m (50 ft)	800-110	30.5 m (100 ft)	800-111	61 m (200 ft)	800-112		
CABLE LENGTH	MODEL												
7.6 m (25 ft)	800-109												
15.2 m (50 ft)	800-110												
30.5 m (100 ft)	800-111												
61 m (200 ft)	800-112												
	<p>GPIB CABLES:</p>												
	<p>DESCRIPTION: GPIB cables interconnect instruments on GPIB.</p>												
	<table border="1"> <thead> <tr> <th>CABLE LENGTH</th> <th>MODEL</th> </tr> </thead> <tbody> <tr> <td>1 m (3.3 ft)</td> <td>2100-1</td> </tr> <tr> <td>2 m (6.6 ft)</td> <td>2100-2</td> </tr> <tr> <td>4 m (13.2 ft)</td> <td>2100-4</td> </tr> <tr> <td>0.5 m (1.6 ft)</td> <td>2100-5</td> </tr> </tbody> </table>	CABLE LENGTH	MODEL	1 m (3.3 ft)	2100-1	2 m (6.6 ft)	2100-2	4 m (13.2 ft)	2100-4	0.5 m (1.6 ft)	2100-5		
CABLE LENGTH	MODEL												
1 m (3.3 ft)	2100-1												
2 m (6.6 ft)	2100-2												
4 m (13.2 ft)	2100-4												
0.5 m (1.6 ft)	2100-5												
	<p>OPEN/SHORT:</p>												
	<p>DESCRIPTION: Open/short with connectors to match the test port of the selected SWR Autotester.</p>												
	<table border="1"> <thead> <tr> <th>MODEL</th> <th>CONNECTOR</th> </tr> </thead> <tbody> <tr> <td>22A</td> <td>APC-7</td> </tr> <tr> <td>22N</td> <td>Type N Male</td> </tr> <tr> <td>22NF</td> <td>Type N Female</td> </tr> <tr> <td>22S</td> <td>WSMA Male</td> </tr> <tr> <td>22SF</td> <td>WSMA Female</td> </tr> </tbody> </table>	MODEL	CONNECTOR	22A	APC-7	22N	Type N Male	22NF	Type N Female	22S	WSMA Male	22SF	WSMA Female
MODEL	CONNECTOR												
22A	APC-7												
22N	Type N Male												
22NF	Type N Female												
22S	WSMA Male												
22SF	WSMA Female												
	<p>10BX and 10BX-1 CABLES:</p>												
	<p>The 10BX and 10BX-1 cables enable SWR Autotesters and RF detectors other than the 560 series components to be used with the Model 560A Scalar Network Analyzer. The 10BX cable is used with Si detectors, and the 10BX-1 cable is used with GaAs detectors.</p>												
	<p>Cable Length — 122 cm (4 ft.)</p>												
	<p>9-TO-25-PIN ADAPTER CABLE:</p>												
	<p>Provides interconnection between the 560A and the 6600A series sweep generators. P/N 560A-D-11359.</p>												

1-6 DESCRIPTION OF THE INTERFACE BUS

The IEEE 488 bus (General Purpose Interface Bus--GPIB) is an instrumentation interface for integrating instruments, calculators, and computers into systems. The bus uses sixteen signal lines to effect transfer of data and commands to as many as fifteen instruments. The instruments on the bus are connected in parallel, as shown in Figure 1-4. Eight of the signal lines (DIO 1 thru DIO 8) are used for the transfer of data and other messages in a byte-serial, bit-parallel form. The remaining eight lines are used for communications timing (handshake), control, and status information. Data is transmitted on the eight GPIB data lines as a series of eight-bit characters referred to as bytes. Normally, a seven-bit ASCII (American Standard Code for Information Interchange) code is used. The eighth (parity) bit is not used. Data is transferred by means of an interlocked handshake technique. This sequence permits asynchronous communications over a wide range of data rates. The following paragraphs provide an overview of the data, management, and handshake buses and describe how these buses interface with the network analyzer.

1-6.1 Data Bus Description

The data bus contains eight bi-directional active-low signal lines, DIO 1 thru DIO 8. One byte of information (eight bits) is transferred over the bus at a time. DIO 1 represents the least-significant bit (LSB) in the byte; DIO 8 represents the most-significant bit (MSB) in the byte. Each byte represents a peripheral address (either primary or secondary), a control word, or a data byte. Data bytes are usually formatted in ASCII code, without parity. The data bus provides the conduit for transmitting control information and data between the controller and the instrument (network analyzer).

1-6.2 Management Bus Description

The management bus is a group of five signal lines that are used to control the oper-

ation of the bus system. Functional information regarding the individual management bus control lines is provided below.

- a. ATN (attention). When this line is true, the 560A will respond to appropriate interface messages (e.g., device clear and serial poll) and to its own listen/talk address.
- b. EOI (end or identify). This line is set true during the last byte of a multi-byte message. This line is also used in conjunction with ATN to indicate a parallel-poll.
- c. IFC (interface clear). When this line is true, the 560A interface functions are placed in a known state, i.e., unaddressed to talk, unaddressed to listen, and service request idle.
- d. REN (remote enable). When this line is true, the 560A is enabled for entrance into the remote state (i.e., certain front panel functions disabled) upon receipt of its listen address. The remote state is exited when either: (1) the REN line is false (high), (2) the go-to-local (GTL) message is received, or (3) the 560A programming command RL (return to local) is received.
- e. SRQ (service request). If programmed for interrupt mode (IM) operation (refer to paragraph 3-7.1, d, 2), the 560A will set this line true to indicate that it requires service.

1-6.3 Data Byte Transfer Control (Handshake) Bus Description

Information is transferred on the data lines under control of a technique called the three-wire handshake. The three handshake bus signal lines are described below; Figure 1-5 shows a typical interlocking handshake operation.

- a. DAV (data valid). This line is set true (arrow 1) when the talker has (1) sensed that NRPD is false, (2) placed a byte of data on the bus, and (3) waited an appropriate length of time for the data to settle.

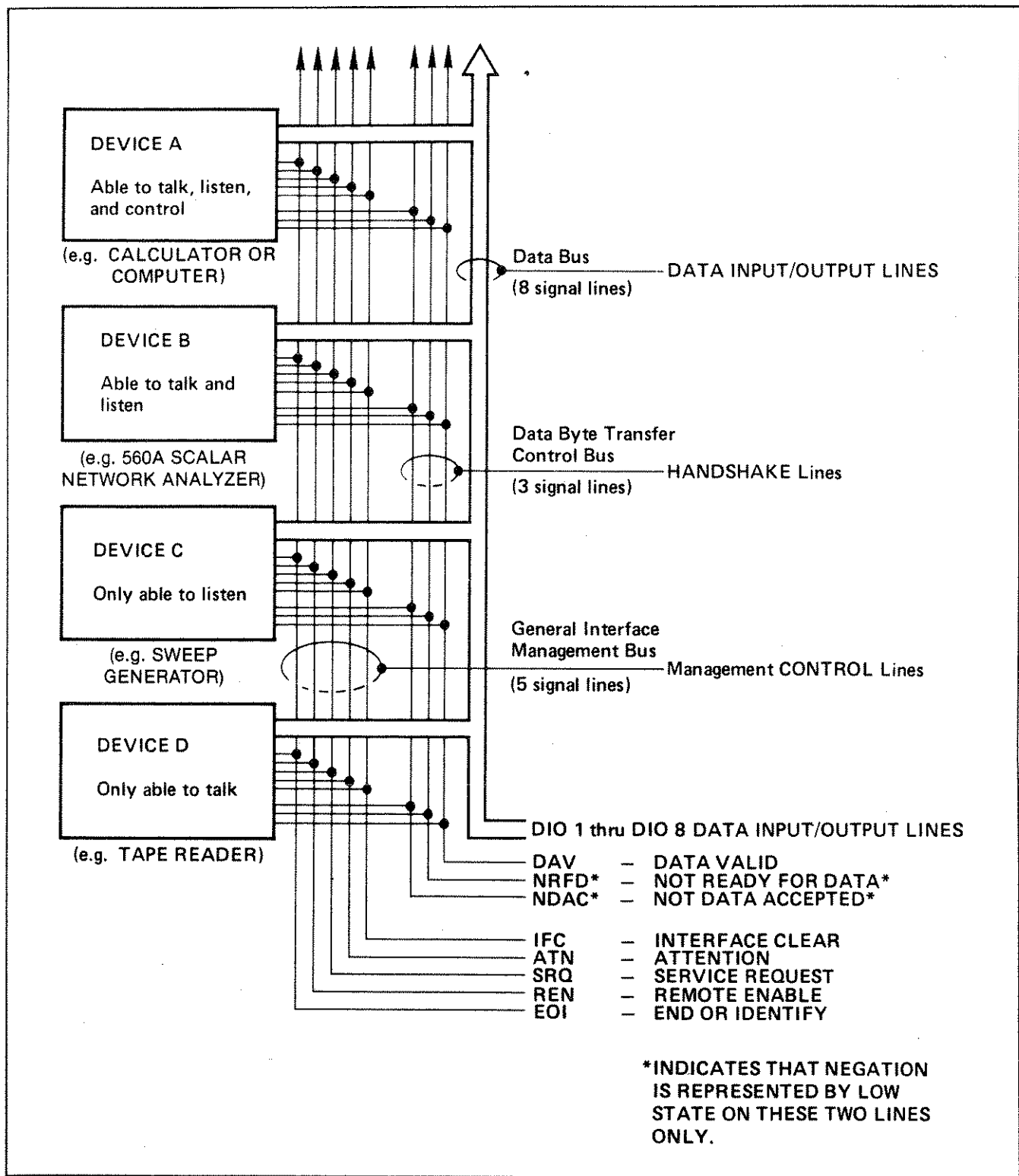

Figure 1-4. Interface Connections and Bus Structure

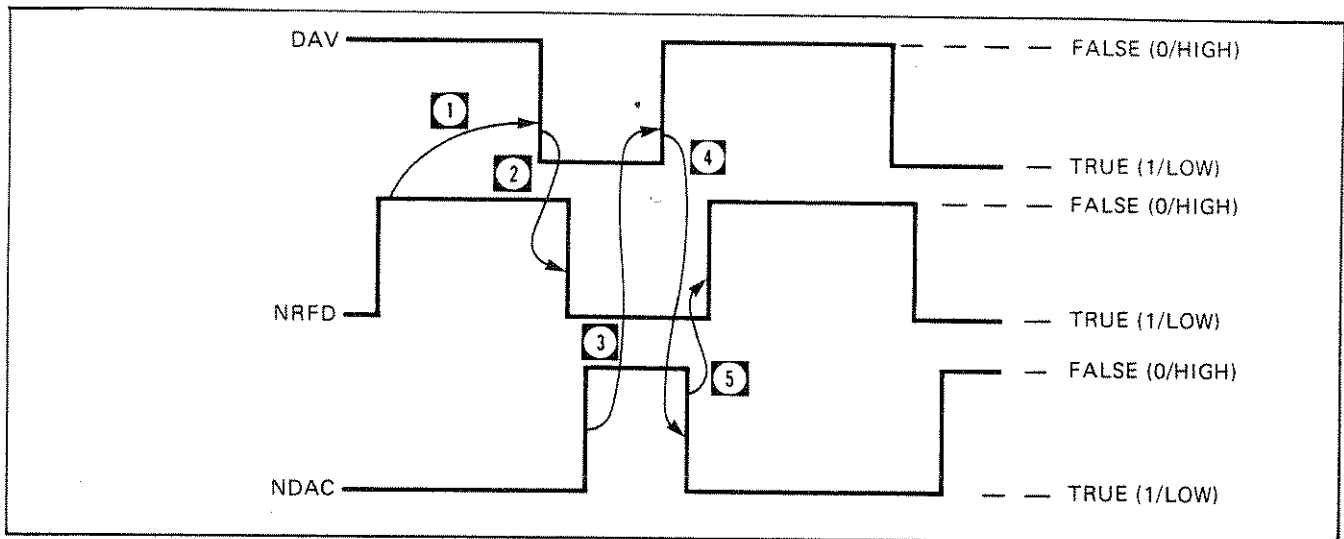

Figure 1-5. Typical Handshake Operation

b. NRFD (not ready for data). This line is set true (arrow 2) by a listener to indicate that valid data has not yet been accepted. The time between the events shown by arrows 1 and 2 is variable and depends upon the speed with which a listener can accept the information.

c. NDAC (not data accepted). This line is set false by a listener when the listener has accepted the current data byte for internal processing. When the data byte has been accepted, the listener releases its hold on NDAC and allows the line to go false. However, because the GPIB is constructed in a wired-OR configuration, this line will not go false until all listeners participating in the interchange have also released the line. As shown by the arrow labeled 3, when the NDAC line goes false the DAV line follows suit a short time later. The false state of the DAV line indicates to the bus that valid data has been removed; consequently, with valid data no longer on the line, the NDAC line is pulled low again in preparation for the next data interchange. This action is shown by the arrow labeled 4.

The next action that occurs is shown by arrow 5. This arrow shows NRFD going false following NDAC returning to its

true state. The false state on NRFD indicates to the bus that all listeners are ready for the next information interchange. The time period between these last two events (NDAC going true and NRFD going false) is variable and is dependent upon the length of time that it takes a listener to process the data byte. Therefore, the result of the wired-OR construction of the handshake bus is that a talker is forced to wait for the slowest instrument to accept the current data before it can place a new byte of information on the bus.

1-7 RF DETECTOR-DIODE REPLACEMENT

Field replacement of the detector diode is possible with both the 560-6 series SWR Autotesters, and the 560-7 and 560-71 series RF detectors. In the 560-7 series detectors, the diode is encased in a module; WILTRON part numbers are 560-7219A (0. to 18.5 GHz), -7219B (0.01 to 26.5 GHz), and -7219C (0.01 to 34.0 GHz). In both the 560-6 series SWR Autotesters and the 560-71 series RF detectors, the diodes are discrete components. For the SWR Autotesters, the diode part number is 10-9; for the detectors, the diode part number is 10-21. Parts ordering information is contained in Section VI, Parts Lists, and replacement instructions are contained in Section VII, Service.

SECTION II

INSTALLATION

2-1 INTRODUCTION

This section provides information on initial inspection, preparation for use, and General Purpose Interface Bus (GPIB) interconnections. Also included is information concerning reshipment and storage of the network analyzer and its dedicated microwave components.

2-2 INITIAL INSPECTION

Inspect the shipping container for damage. If the container or cushioning material is damaged, retain it until the contents of the shipment have been checked against the packing list, and the instrument has been checked for mechanical and electrical operation.

If the 560A is damaged mechanically, notify your local sales representative or WILTRON Customer Service. If either the shipping container is damaged or the cushioning material shows signs of stress, notify the carrier as well as WILTRON. Keep the shipping materials for carrier's inspection.

2-3 PREPARATION FOR USE

Preparing the Model 560A Scalar Network Analyzer for use consists of three operations. These three operations - selecting the operating voltage, interconnecting the 560A with a sweep generator, and normalizing the input horizontal sweep voltages - are described in the following paragraphs.

2-3.1 Selection of Operating Voltage

The Model 560A comes equipped with a voltage selector module that enables the network analyzer to be used with any of four international line voltages: 100, 115/120, 220, and 230/240 Vac. Each 560A is preset and tagged at the factory for the line

voltage used in the customer's country. If the line voltage in the user's area is the same as that stated on the tag, the user can proceed to paragraph 2-3.2. If, however, the line voltage is different from that stated on the tag, the user can reconfigure the voltage selector module (Figure 2-1) using the following procedure.

- a. Disconnect the power cord from the voltage selector module (1) and slide the cover (2) to the left to gain access to the fuse compartment.
- b. Pull forward on FUSE PULL (3) and remove line fuse (4).
- c. To select operating voltage:
 1. Pull FUSE PULL to left and remove PC board.

NOTE

The PC board is tightly secured within the module housing. It may be necessary to use needle-nose pliers or a similar tool as a pry.

2. Orient PC board so that the desired voltage is facing up and on the left side of the board.
3. With desired voltage facing up, re-install PC board into its slot. Press firmly to seat the board.
4. Push FUSE PULL back to its normal position and insert a fuse of the proper value (as indicated on the bottom of the module) into the fuse holder.

2-3.2 Sweep Generator Interconnection

The Model 560A Scalar Network Analyzer requires input from a microwave sweep

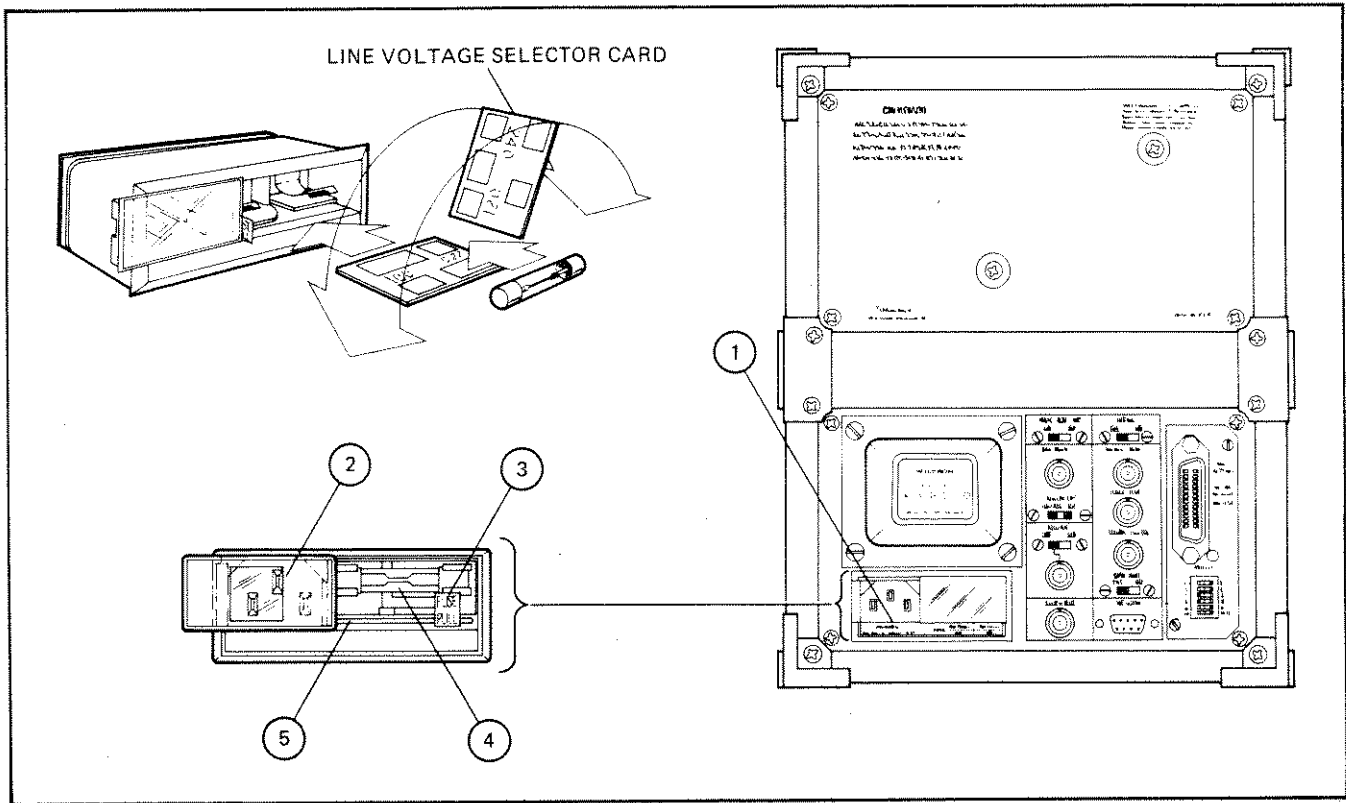

Figure 2-1. Line Voltage Selector Module

generator. Although the 560A was designed to operate with the WILTRON 6600(A) Series Programmable Sweep Generator, it is compatible with most other sweep generators. The only requirement is that the sweep generator be able to supply the required horizontal sweep ramp, retrace blanking, and marker voltages. These voltages are specified in Table 1-1, Model 560A Scalar Network Analyzer Specification Chart. Figure 2-2 shows the interconnections between the 560A and the WILTRON 6600(A) Series Programmable Sweep Generators.

NOTE

The rear panel HORIZONTAL SELECT switch must be set to the position that corresponds to the particular horizontal input ramp: 0 to +10V, 0 to +15V, or -8V to +8V.

2-3.3 Horizontal Sweep Ramp Normalization

Normalization of the horizontal sweep ramp sets the input ramp voltage to start at 0 volts and to stop at 10 volts. Normalization is necessary to make the analog real time ramp "fit" the digital storage and refresh memory circuits. The two front panel screwdriver potentiometers labeled HORIZ-START and -STOP are the normalization adjustments. The START potentiometer, in conjunction with an internal clamping circuit, adjusts the ramp to start at 0 volts; the STOP potentiometer, also in conjunction with an internal clamping circuit, adjusts the ramp to stop at 10 volts. If the START potentiometer is misadjusted, horizontal and vertical data at the low end of the frequency band will be lost; if the STOP potentiometer is misadjusted, horizontal and vertical data at the high end of the frequency band will be lost. Adjust the START and STOP potentiometers as follows:

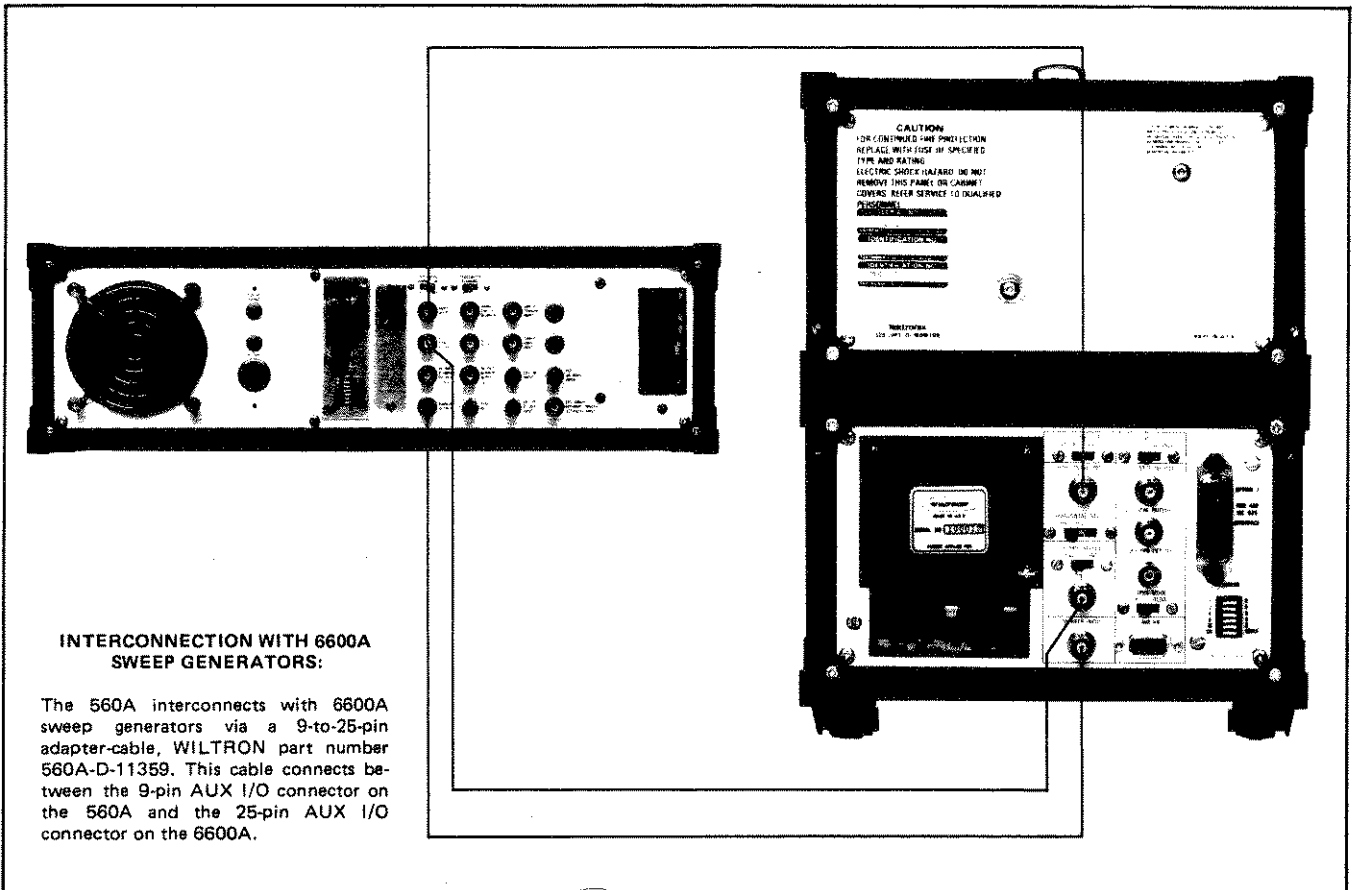
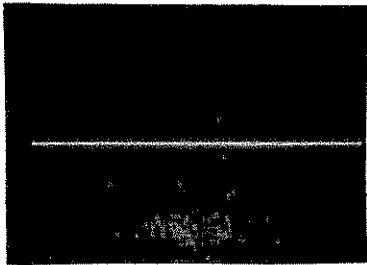

Figure 2-2. Interconnections between WILTRON 6600(A) Series Programmable Sweep Generator and Model 560A Scalar Network Analyzer

- a. Interconnect the 560A with a sweep generator (paragraph 2-3.2) and adjust the sweep generator controls to provide a 50 ms (approximate) sweep.
- b. Turn on the 560A by depressing POWER pushbutton switch. Power ON indicator should light.
- c. Turn on Channel A by depressing CHANNEL A ON pushbutton switch. The Channel A OFFSET dB display and either the dB or dBm indicator should light.
- d. Insure Channel B is off by observing that the CHANNEL B ON pushbutton switch is not depressed and that none of the Channel B indicators are lit.
- e. Place the 560A in real time display mode by depressing REAL TIME pushbutton switch.
- f. Locate horizontal trace by depressing and holding the REF POS LOCATE pushbutton switch. Position trace on center graticule line by adjusting SET screwdriver potentiometer.
- g. Adjust START and STOP potentiometers as follows:
 1. With REF POS LOCATE depressed, observe CRT and rotate START potentiometer clockwise until left trace-end dot begins to move right; then stop.

2. Rotate START potentiometer counter-clockwise until trace-end stops moving left and dot begins to intensify; stop counter-clockwise rotation. Left trace movement should stop on or within 1 minor division from left-hand graticule edge. If trace-end dot movement is not as described, refer to Table 3-5.
3. Rotate STOP potentiometer clockwise until trace-end stops moving right. Right trace movement should stop on or within 1 minor division from right graticule edge. If trace-end dot movement is not as described, refer to Table 3-5. An example of a properly aligned trace is shown below.



4. Release REF POS LOCATE.

2-4 GPIB SETUP AND INTERCONNECTION

With Option 3 installed (the option can be installed in the field), the Model 560A Scalar Network Analyzer is capable of providing automated microwave measurements via the GPIB. Specific GPIB information – including interface connections, cable requirements, and addressing instructions – is contained in the following paragraphs.

2-4.1 Interface Connector

Interface between the Model 560A and other devices on the GPIB is via a 24-wire interface cable. The interface cable is specially constructed with each end containing a connector shell with two connector faces. These double-faced connectors allow for the parallel connection of two or more cables to a single device. Figure 2-3 shows the pin assignments for the Type 57 connector installed on the 560A rear panel. Table 1-4, Accessories, contains leading particulars on the WILTRON cable assemblies. The WILTRON cables may be ordered by special request. Refer to Section VI for parts-ordering information.

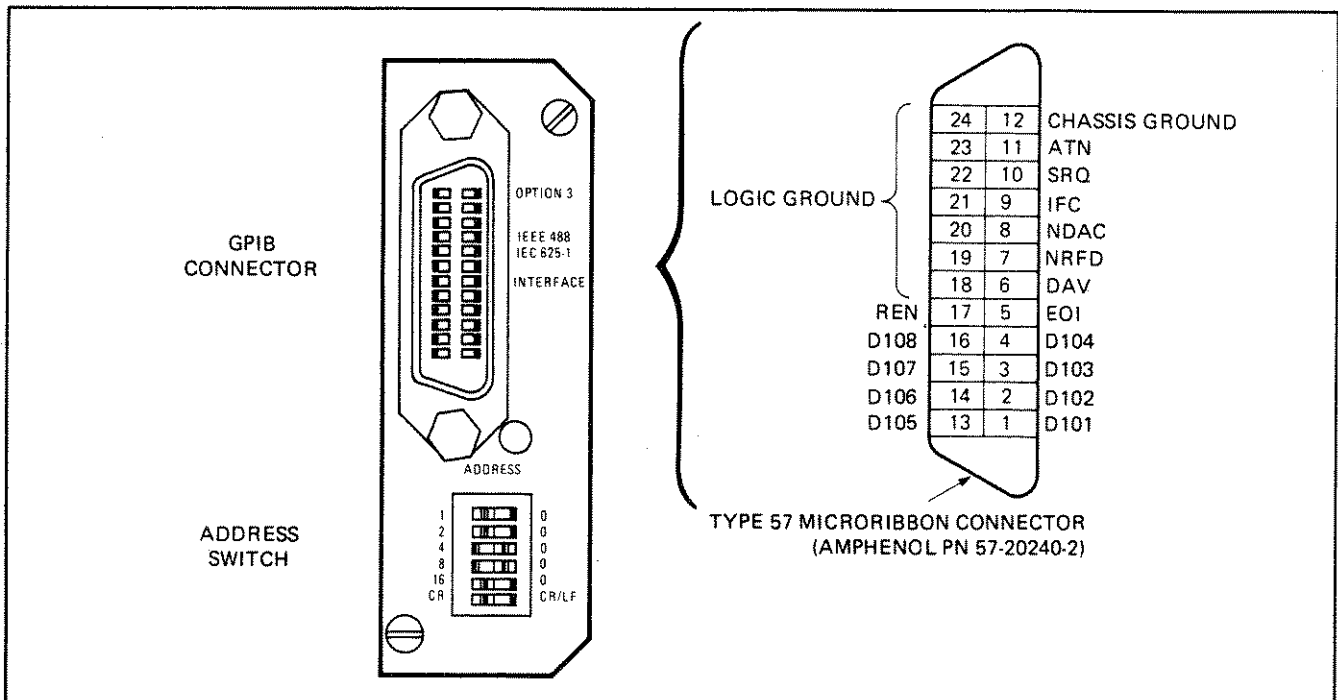

Figure 2-3. Option 3 Panel (Address Switch and GPIB Connector)

2-4.2 Cable-Length Restrictions

The GPIB system can accommodate up to fifteen instruments at any one time. To achieve design performance on the bus, the proper timing and voltage-level relationships must be maintained. If either the cable length between separate instruments or the accumulated cable length between all instruments is too long, the data and control lines cannot be driven properly and the system may fail to perform. Cable length restrictions are as follows:

- No more than 15 instruments may be installed on bus.
- Total accumulative cable length may not exceed 2 times the number of bus instruments in meters or 20 meters, whichever is less.

2-4.3 Interconnecting the Model 560A on the GPIB

The Model 560A is interconnected with a suitable sweep generator and GPIB system controller. Interconnection with other peripheral equipment, e.g. an X-Y plotter, is via the controller. GPIB interconnection is accomplished as follows:

- Interconnection with Sweep Generator. To connect the Model 560A to the sweep generator, refer to paragraph 2-3.2.
- Interconnection with Controller. To connect the Model 560A with the GPIB controller, connect a 1-, 2-, or 4-meter (as required) GPIB interconnect cable between the Option 3 interface connector on the 560A rear panel (Figure 2-3) and a like connector on the controller (refer to controller instruction manual to locate this connector).

NOTE

Since the GPIB is of parallel construction, the interconnect cable from the 560A can also connect to the open face on any other bus instrument's interface connector cable.

2-4.4 Addressing the Model 560A

Addressing the Model 560A to talk and listen is accomplished from the rear panel. The Option 3 panel (Figure 2-3), located on the rear of the Model 560A, contains a vertical row of six white ON/OFF rocker-type switches. The top five switches are used to assign the talk/listen address (talk and listen addresses use the same address number); the bottom switch is used for data delimiting (paragraph 2-4.5).

The five Option 3 address switches are arranged from top to bottom in a binary format, the least significant bit (LSB) located at the top. As shown in Figure 2-3, there are two sets of numbers assigned to switches within the ADDRESS switch row.

The numbers 1, 2, 4, 8, and 16, left and 0, right, represent binary weights; i.e., when a switch's rocker arm is depressed in the direction of the number, the number represents the binary weight of the switch. To determine the talk/listen address that has been assigned, note the positions of the switch rocker arms and add, in decimal addition, the binary weights. The sum of that addition is the talk/listen address that the Model 560A responds to. For example, assume that the first, third, and fifth switches, from top to bottom, have been depressed to the left. The decimal sum of the weighted digits 1, 4, and 16 is 21--the talk/listen address.

When assigning a talk/listen address, any number from 0 to 30 may be used. However, no two GPIB instruments can share the same address number. The tabulation in Figure 2-4 shows the available decimal address numbers, the ASCII character assigned to each number, and the binary arrangement of 1's and 0's to which the number is equivalent. Keep in mind that the most significant bit (MSB) is the left-most digit. This is the binary position that corresponds to the fifth-from-the-top switch on the Option 3 panel. The 560A is shipped from the factory with address switches set to 6.

		(MSB)					(LSB)						
Decimal Address	ASCII Character	16	8	4	2	1	Decimal Address	ASCII Character	16	8	4	2	1
0	Space	0	0	0	0	0	16	0	1	0	0	0	0
1	!	0	0	0	0	1	17	1	1	0	0	0	1
2	"	0	0	0	1	0	18	2	1	0	0	1	0
3	#	0	0	0	1	1	19	3	1	0	0	1	1
4	\$	0	0	1	0	0	20	4	1	0	1	0	0
5	%	0	0	1	0	1	21	5	1	0	1	0	1
6	&	0	0	1	1	0	22	6	1	0	1	1	0
7	'	0	0	1	1	1	23	7	1	0	1	1	1
8	(0	1	0	0	0	24	8	1	1	0	0	0
9)	0	1	0	0	1	25	9	1	1	0	0	1
10	*	0	1	0	1	0	26	:	1	1	0	1	0
11	+	0	1	0	1	1	27	;	1	1	0	1	1
12	,	0	1	1	0	0	28	<	1	1	1	0	0
13	-	0	1	1	0	1	29	=	1	1	1	0	1
14	.	0	1	1	1	0	30	>	1	1	1	1	0
15	/	0	1	1	1	1							

Switch ON = 1
Switch OFF = 0

Figure 2-4. Available Address Codes and Corresponding Address Switch Positions

2-4.5 Data Delimiting (CR-CR/LF Switch)

As described in the preceding paragraph, the bottom switch on the Option 3 panel is used for data delimiting. Data delimiting, as it applies to the GPIB, is the method by which a talker signals to the controller that data or control transmission has finished.

Two ASCII characters are used for the data-delimiting function. These characters are: carriage return (CR) and line feed (LF). The position of the CR-CR/LF switch determines which character or combination of characters is sent over the bus by the Model 560A. Some controllers want CR, some controllers want both CR and LF, and other controllers do not care. For example, the Commodore PET 2001 controller wants CR only, the Hewlett-Packard 9825A and 85 want both CR and LR (CR/LF), and the Tektronix 4051 will accept either CR or CR/LF.

2-5 PREPARATION FOR STORAGE AND/OR SHIPMENT

2-5.1 Preparation for Storage

Preparation for storage involves cleaning the unit, packing the inside of the unit with moisture-absorbing dessicant crystals, and storing the unit in a proper environment. Environmental storage conditions for the Model 560A are listed in Table 1-1.

2-5.2 Preparation for Shipment

To provide maximum protection against damage in transit, the Model 560A should be repackaged in the original shipping container. If this container is no longer available and the 560A is being returned to WILTRON for repair, contact Customer Service and a new shipping container will be sent to you free of charge. In the event neither of these two options is possible,

follow the instructions below.

- a. Use a Suitable Container. Obtain a corrugated cardboard carton with a 275-pound test strength and inside dimensions of no less than six inches more than the instrument dimensions; this allows for cushioning.
- b. Protect the Instrument. Surround the instrument with polyethylene sheeting to protect the finish.
- c. Cushion the Instrument. Cushion the instrument on all sides by tightly packing dunnage or urethane foam between the carton and the instrument, allowing three inches of cushioning on all sides.
- d. Seal the Container. Seal the carton with shipping tape or with an industrial stapler.
- e. Address the Container. If the instrument is being returned to WILTRON for service, mark the WILTRON address, as shown below, and your return address on the carton in one or more prominent locations. The WILTRON address is:

WILTRON Company
ATTN: Customer Service
825 E. Middlefield Road
Mountain View, CA 94043

A rectangular label with a wavy border containing the word "CAUTION" in bold, uppercase letters.

If the microwave components, i. e. , SWR Autotester and RF Detector(s), are being returned with the network analyzer, package them separately. Packaging network analyzer and microwave components in the same carton can result in damage to the equipment.

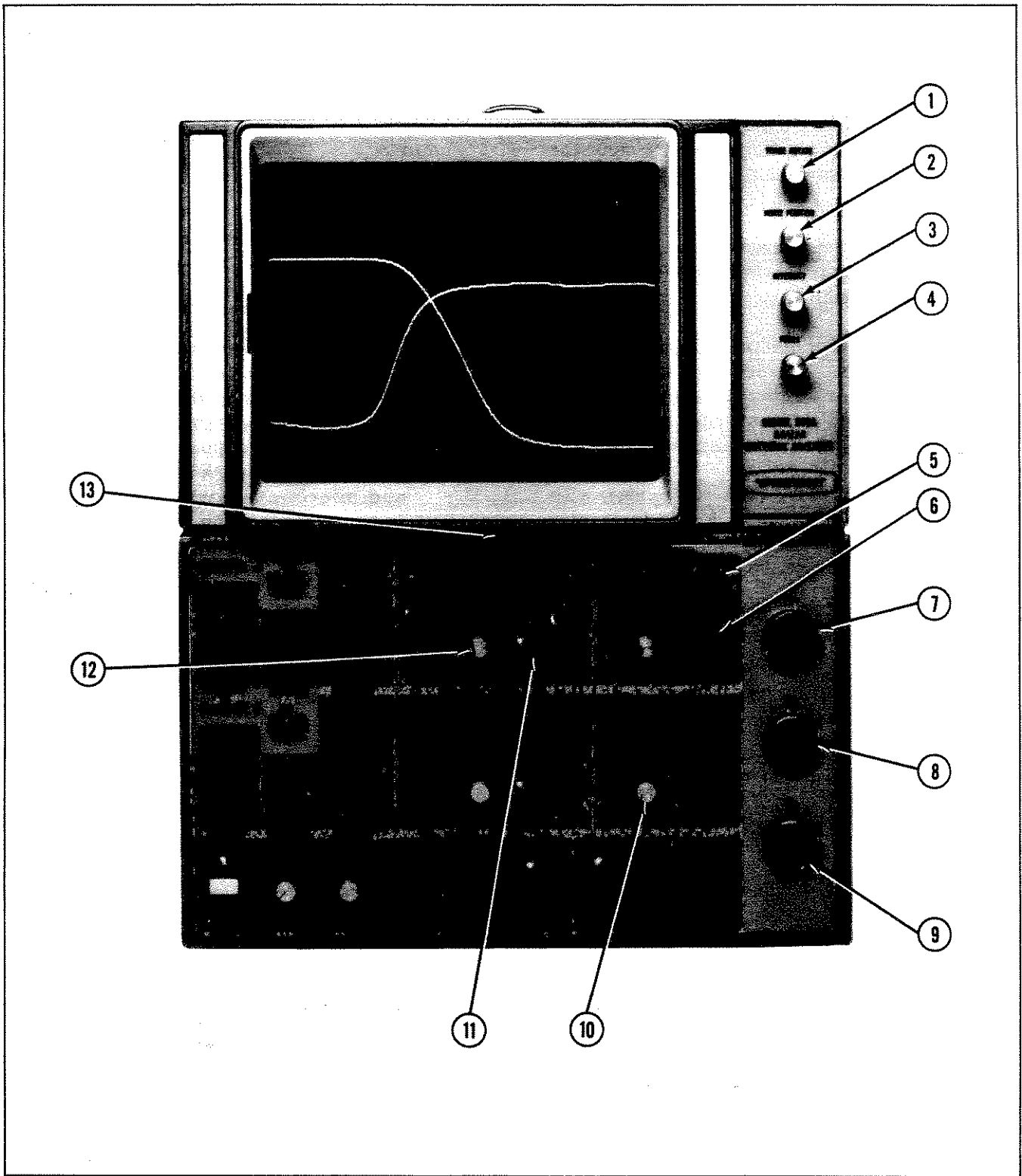

Figure 3-1a. Front Panel Controls, Connectors, and Indicators

SECTION III OPERATION

3-1. INTRODUCTION

This section provides information on 560A front and rear panel controls, operational checkout, and Option 3 GPIB operation. The GPIB information includes general information and a description and summary of GPIB command codes.

3-2. CONTROLS AND CONNECTORS

3-2.1 Front Panel Controls and Connectors

Front panel controls and connectors are indexed in Figures 3-1a and 3-1b. As shown by front panel shading, controls are arranged in three functional groups. The top group of controls are for Channel A, the middle group are for Channel B, and the bottom group of controls are common to both channels. Controls for Channels A and B function identically for their respective channels; consequently, only the Channel A controls are described.

- ① TRACE ROTATE - adjusts slope of displayed trace (paragraph 3-4.3).
- ② HORIZ POSITION - adjusts horizontal position of displayed trace (paragraph 3-4.3).
- ③ INTENSITY - controls intensity of displayed trace.
- ④ FOCUS - controls focus of displayed trace.
- ⑤ OFFSET dB - indicates offset in dB from zero dB reference when REFERENCE dB/dBm pushbutton switch is in dB position. When REFERENCE dB/dBm is in dBm position, OFFSET dB indicates absolute power in dBm at point where trace crosses reference line.

⑥ OFFSET ZERO - returns OFFSET dB display readout to 00.0 and moves trace to 0 dB reference position.

⑦ A - input connector for Channel A.

⑧ B - input connector for Channel B.

⑨ R - input connector for reference channel.

⑩ OFFSET - controls vertical position of displayed trace. Used in conjunction with REFERENCE dB/dBm pushbutton switch and OFFSET dB display to provide either absolute power (dBm) or relative power (dB) measurements at point where trace crosses reference line (refer to paragraph 3-3.3).

⑪ REFERENCE dB/dBm - determines which measurement units (dB or dBm) will be used. When dB indicator is lit, OFFSET dB display readout is in dB. When dBm indicator is lit, OFFSET dB display readout is in dBm. When dBm indicator flashes, OFFSET dB display readout is uncalibrated for absolute power measurements. The 560A is uncalibrated for dBm measurements when INPUT is in A-R (B-R) mode or when MEMORY is in SUBTRACT, AVG, or RECALL mode.

⑫ ZERO dB SET - used during relative power (dB) measurements (REFERENCE dB/dBm pushbutton switch in dB position) to control the position of the 0 dB reference; control is inoperative in the dBm mode (refer to paragraph 3-3.3).

⑬ dB PER DIVISION - group of pushbutton switches which determine vertical resolution of displayed signals. Each switch has a value, as indicated. For values other than those indicated, e.g., 3, 6, 12, etc., depress two or more switches. The sum of the depressed-switch values equals the dB per division resolution.

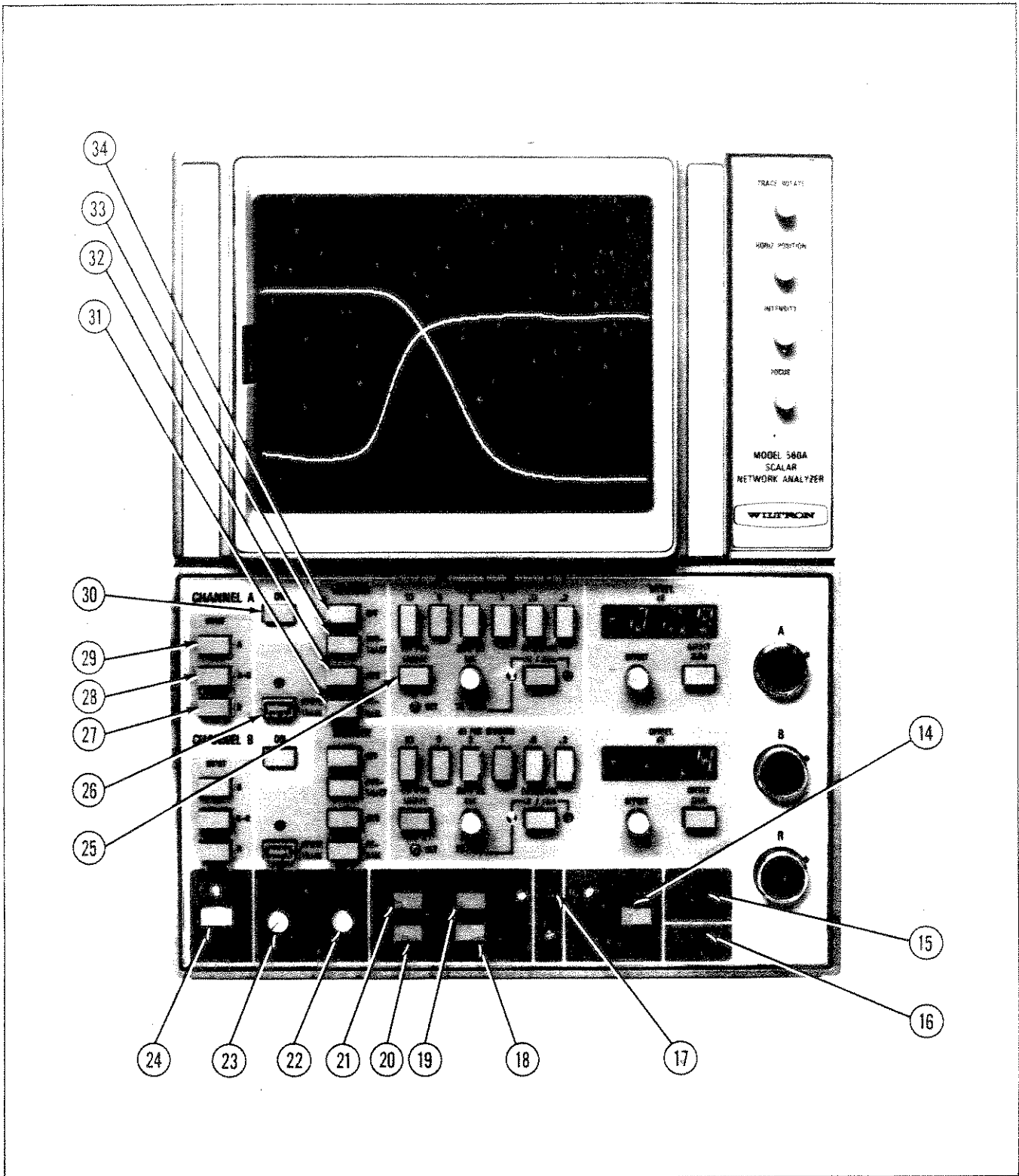

Figure 3-1b. Front Panel Controls, Connectors, and Indicators

- ⑭ SMOOTHING - three-position switch (OFF, MIN, MAX) provides two levels of filtering, thereby improving the display at low signal levels.
- ⑮ UNCAL - lights to indicate that the input horizontal ramp voltage is changing faster than internal memory can process and store data.
- ⑯ REMOTE - lights to indicate that the 560A is operating under GPIB control.
- ⑰ HORIZ START and STOP - potentiometers used to normalize the input horizontal sweep range voltage. START adjusts start of sweep (left side of CRT) and STOP adjusts end of sweep (right side of CRT). (Refer to paragraph 2-3.3.)
- ⑱ X-Y PLOT - switches X and Y data to rear panel BNC connectors for input to X-Y plotter. This control operates in conjunction with REFRESH and REAL TIME pushbutton switches (refer to paragraph 3-3.5).
- ⑲ REFRESH HOLD - stops updating of refresh display, thereby freezing it.
- ⑳ REAL TIME - displays input data in real (sweep generator frequency sweep) time. Also, provides real time data to rear panel HORIZONTAL OUTPUT connector.
- ㉑ REFRESH - displays input data at a constant 14 ms rate. When both REFRESH and X-Y PLOT pushbutton switches are depressed, refresh data is held (not updated) in memory and read out at a 30 s rate. The 30 s sweep is applied to the rear panel HORIZONTAL OUTPUT connector (refer to paragraph 3-3.5).
- ㉒ TILT - tilts displayed marker pips from -45° to $+45^\circ$.
- ㉓ THRESHOLD - controls on/off and threshold level of input markers.
- ㉔ POWER - applies line power to instrument.
- ㉕ REF POS LOCATE - locates the reference line used for absolute (dBm) or relative (dB) power measurements. This is the line about which the display expands. When depressed, displayed trace disappears and reference appears as a horizontal line. Reference line can be repositioned by adjusting the SET potentiometer.
- ㉖ STORE TRACE - stores displayed trace in internal memory. Red indicator remains lit until data is stored.
- ㉗ R - displays reference channel on Channel A.
- ㉘ A-R (Ratio Mode) - subtracts reference channel input from A channel input; result is displayed on Channel A.
- ㉙ A - displays Channel A.
- ㉚ CHANNEL A ON - switches dc power to Channel A circuits. When both this switch and the CHANNEL B ON switch are off (not depressed), the Model 560A will display Channel A.
- ㉛ RECALL - used to recall data stored in memory.
- ㉜ AVG - averages data stored in memory with selected channel input (R, A-R, A).
- ㉝ SUBTRACT - subtracts data stored in memory from selected channel input (R, A-R, A).
- ㉞ OFF - allows selected channel output (R, A-R, A) to bypass MEMORY SUBTRACT or MEMORY AVG circuits and be displayed on Channel A.

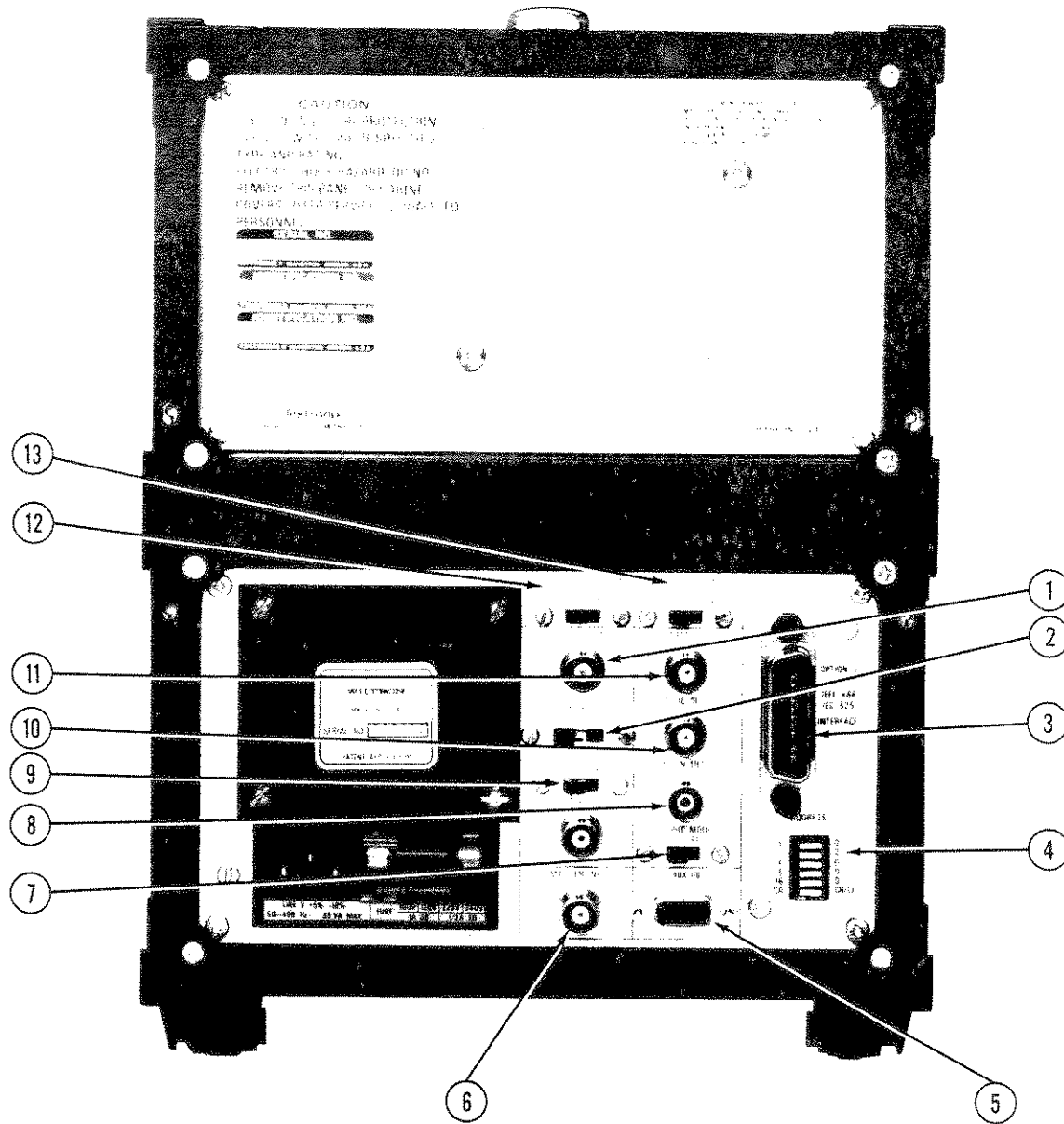

Figure 3-2. Rear Panel Controls and Connectors

3-2.2 Rear Panel Controls and Connectors

The Model 560A rear panel controls and connectors are described below. Refer to Figure 3-2 for the location of each item.

① HORIZONTAL INPUT - provides input for horizontal sweep ramp from sweep generator.

- ② HORIZONTAL SELECT - 3-position switch. Selects the proper sweep start and stop range for three possible horizontal sweep ramp inputs: 0 to +10V, 0 to +15V, and -8V to +8V.
- ③ IEEE 488, IEC 625 INTERFACE (Option 3) - provides input/output connector for GPIB interface (paragraph 2-4.3).
- ④ ADDRESS (Option 3) - six rocker switches. Each of the top five switches determines the 560A's GPIB talk/listen address; for an explanation of these switches, refer to paragraph 2-4.4. The sixth switch, (CR, CR/LF) selects the data-delimiting character; for an explanation of this switch, refer to paragraph 2-4.5.
- ⑤ AUX I/O - D-type subminiature connector. Provides horizontal input, external Z-axis, marker, blanking/pen lift, and alternate-sweep connections between the sweeper and the 560A. To display alternate sweeps on the 560A, the sweeper must have two alternate-sweep control signals: (1) an alternate-sweep line that goes TTL-low to indicate the alternate-sweep input, and (2) an alternate line that goes TTL-high for Channel A display and TTL-low for Channel B display.
- ⑥ MARKER INPUT - provides input for externally-generated marker signals.
- ⑦ OUTPUT MODE - 2-position switch. In CRT position, the horizontal and vertical signals are present at the HORIZONTAL OUTPUT and VERTICAL OUTPUT jacks while positive-TTL blanking pulses are present during retrace. In the RCDR position, the horizontal and vertical signals are disconnected from their output jacks, and the normally-open relay contacts at the BLANK/PEN LIFT OUT jack ⑧ cause the recorder pen to lift off the paper during retrace. The lifted pen is then held off the paper until the next sweep. Can be modified internally for normally-closed contact operation.
- ⑧ BLANK/PEN LIFT OUT - provides either blanking pulses or connection to pen lift relay contacts, depending upon the setting of the OUTPUT MODE switch ⑦.
- ⑨ Z AXIS SELECT - 2-position switch. Selects (1) internally generated signals for retrace blanking and bandswitch points (INT position), or (2) external Z-axis input (EXT position). If a sweeper (WILTRON 6600 series) places a dwell on the sweep ramp to produce an intensity marker, the Z-axis signal from the sweeper must be connected to the Z AXIS INPUT connector, and the switch must be set to EXT position to display the intensity marker on the 560A. Also, if the HP 8620's harmonic markers are to be displayed, its Z-axis signal must be connected to the 560A as described above for the EXT position.
- ⑩ VERTICAL OUTPUT - provides output connections for vertical, Y-axis signal. This signal varies from 0 to ±8V (1V/division), in proportion to the amplitude of the displayed signal plus the overrange (CRT has an 8-division vertical display overrange).
- ⑪ HORIZONTAL OUTPUT - provides output connection for CRT horizontal signal. Horizontal signal is a ramp that varies from 0 to +10V in sync with the displayed sweep. Connects to X-input of external oscilloscope or X-Y plotter.
- ⑫ LOW LEVEL CAL - 2-position switch. In NORM position, 560A processes input signals that fall within the specified range of the 560A. This setting is for normal instrument operation. In the EXT position, 560A processes extremely low-level signals. For these low levels, the RF output of the sweeper must be off (<60 dBm) during retrace.
- ⑬ INPUT - 2-position switch. In the NORM position, the CRT displays either Channel A, B, or both, depending upon the front panel control settings. In the A ONLY position, only the A input is detected and displayed on the CRT. Also, if the CHANNEL B INPUT button is depressed and the Channel B display controls are properly set, a second display of the A input will appear.

3-2.3 Side Panel Controls

The Model 560A right side panel controls are described below. Refer to Figure 3-3 for the location of each item.

① LOW LEVEL TRIM, CH A - Optimizes Channel A for measurements below -45 dBm.

② LOW LEVEL TRIM, CH B - Optimizes Channel B for measurements below -45 dBm.

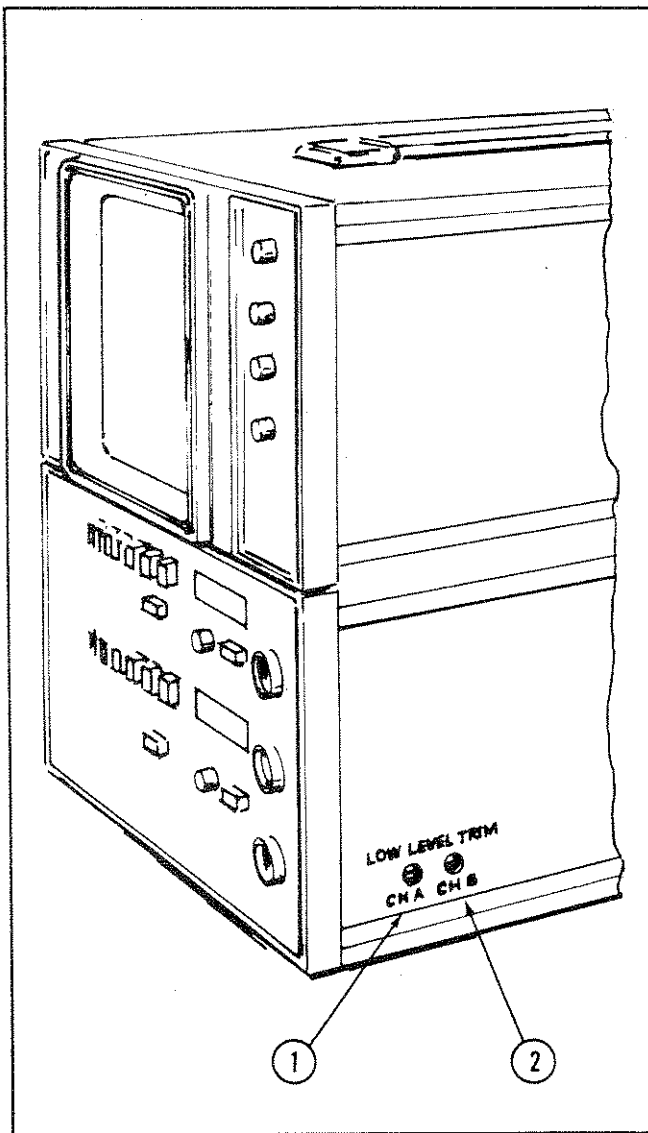

Figure 3-3. Side Panel Controls

3-3 USING FRONT PANEL CONTROLS

Front panel controls are arranged in six functional groups: input, memory, vertical scale factor, marker, display mode, and smoothing. The following paragraphs contain both a detailed description and instructions on how to use each control.

3-3.1 Input Controls

Input controls allow selection of the manner in which the RF measurement inputs are connected to the display and memory circuits. There are three input channels and two display channels available. Input controls allow the selection of A, B, R, A-R, or B-R — where R is the reference channel. The rear panel INPUT switch selects the A ONLY mode (paragraph 7-12.1).

- a. A or B Measurement Controls. These pushbuttons connect the output of the SWR Autotester to A or B Channel for return loss measurements, or the output of the RF Detector to A or B Channel for transmission loss/gain or absolute power measurement. See Figure 3-4 for a typical transmission loss/gain and return loss measurement setup.
- b. R Reference Controls. These pushbuttons connect the output of the RF detector to R Channel logarithmic amplifier

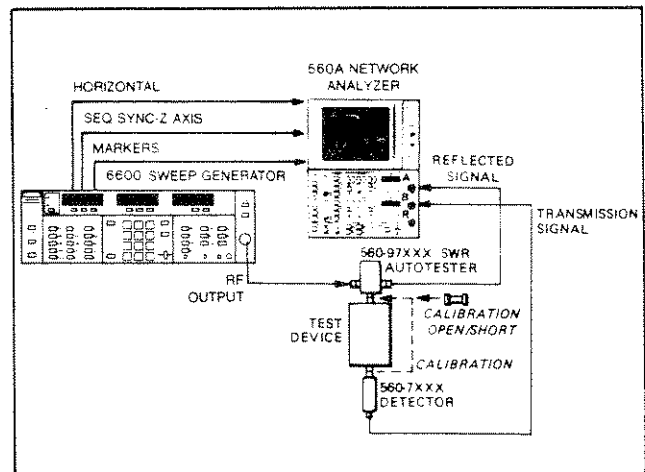

Figure 3-4. Return Loss and Transmission Loss/Gain Measurement Equipment Setup

for display on A or B Channel trace. A typical test setup using a power splitter is shown in Figure 3-5. In an equipment setup of this type, the R Channel is available to monitor the incident signal for return loss measurements or the absolute power signal for transmission measurements without having to reconfigure test cables. By depressing the R pushbutton, this data is made available to the CRT.

- c. A-R or B-R Ratio Controls. These pushbuttons subtract the output of the R Channel logarithmic amplifier from the output of the A or B Channel logarithmic amplifier. Subtracting the logarithm of R from the logarithm of A is the same as taking the ratio of the logarithm of A/R; for this reason, A-R and B-R are known as ratio inputs. These ratio inputs have several applications. In transmission measurements, they can be used to improve source match and eliminate the effects of sweep generator power drift, measure very small insertion loss signals more accurately, and track between two components, i. e., measure differences or similarities between two filters, amplifiers, attenuators, etc. In return loss measurements, ratioing can be used (1) to compensate for fluctuations in source

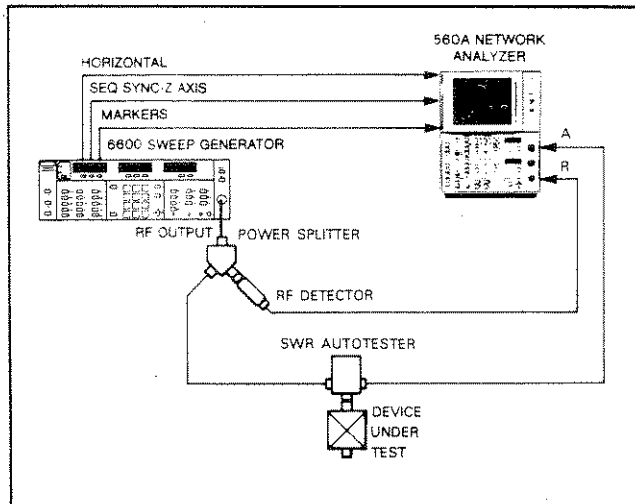

Figure 3-5. Typical Equipment Setup for Using R Channel

power where long transmission lines are used (e. g., measurement of aircraft systems where test equipment is outside the aircraft and system is inside the aircraft) or (2) to eliminate the need for recalibration when source power is deliberately changed by adding attenuation or by changing the sweep generator RF power level control.

3-3.2 Memory Controls

Memory controls are available in both Channel A and Channel B; they provide four operations: (1) storage of input data (STORE TRACE), (2) subtraction of stored data from input data (SUBTRACT), (3) averaging of stored data with input data (AVG), and (4) recall of stored data upon request (RECALL). Two uses for these controls are described below.

a. Using Memory To Store and Subtract Transmission System Residuals.

A primary use of memory is to store microwave transmission measurement system residuals. These residuals, caused by inherent frequency response variations within the measurement system, are later subtracted from measured data. The process of storing residuals and making them available for later subtraction from input data is known as display normalization. An equipment setup for transmission loss/gain and return loss measurements is shown in Figure 3-6. A procedure for normalizing the 560A display is presented in Table 3-1. This procedure, with its notes and waveform photographs, is designed to provide a demonstration of how the memory controls are used during actual measurement applications. The interaction between display and memory that occurs during the Display Normalization Procedure is summarized in Figure 3-7.

- b. Using Memory To Calibrate the Return Loss Measurement System. Another use of memory is in calibrating the SWR Autotester for return loss measurements. The reference reflection for

return loss measurements is the 100% reflection that occurs when the SWR Autotester test port is terminated in either an open or a short. When this reflection is used without compensation, an error is introduced because of test port match. To compensate for this error, a technique known as open/short averaging is used. This technique is based on the fact that the reflection from an open is 180 degrees out of phase from the reflection from a short. Consequently, when these two reflections are averaged together, the test port match error signals cancel. The remaining signal is the 100% reflection from the device under

test. In the 560A, the open/short averaging technique is accomplished with the aid of memory.

The return loss measurement system test setup is shown in Figure 3-8. A procedure for calibrating the SWR Autotester is presented in Table 3-2. This procedure, like the one used for display normalization, is designed to provide a demonstration of how the memory controls are used during actual measurement applications. The interaction between display and memory that occurs during the Return Loss Calibration Procedure is summarized in Figure 3-9.

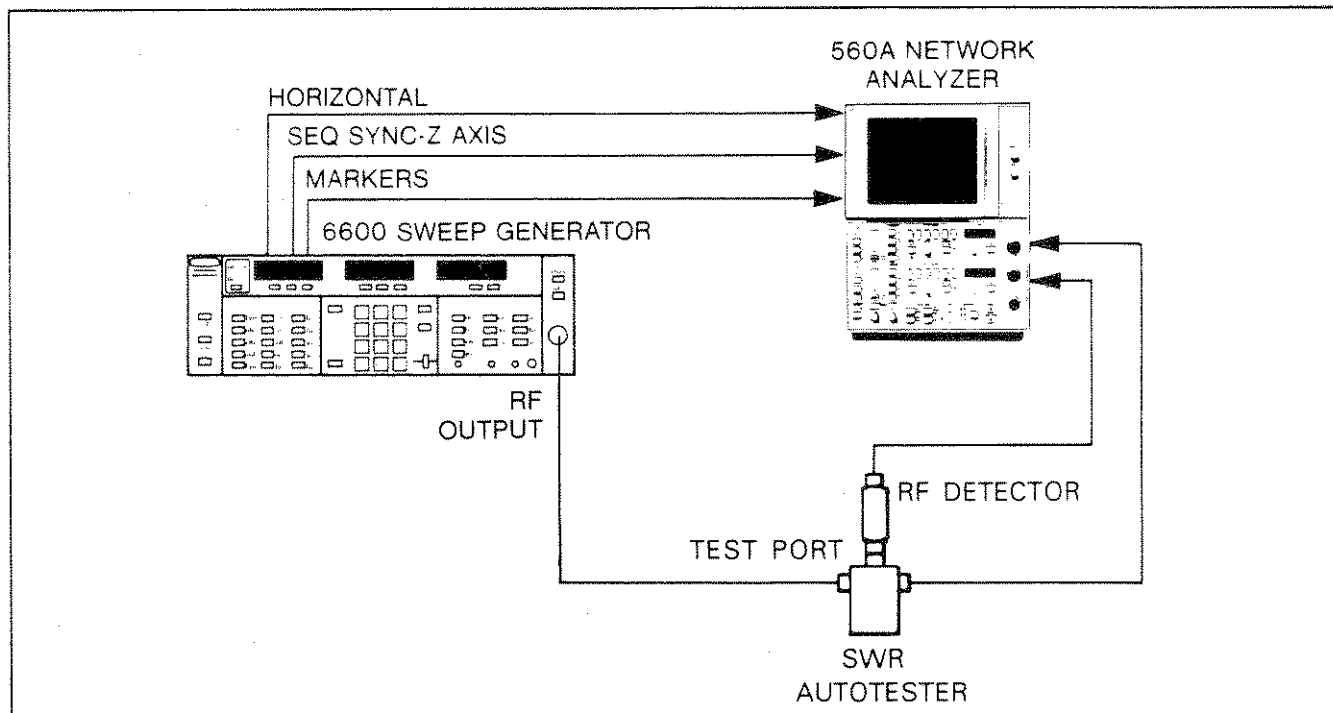

Figure 3-6. Equipment Setup for Storing Transmission System Residuals

Table 3-1. Display Normalization Procedure

<p>1. Set up equipment and perform initial switch positioning:</p> <p><u>Sweep Generator</u></p> <p>MARKERS: VIDEO MARKER AMPLITUDE: Fully CCW TRIGGER: AUTO SWEEP TIME: 50 ms FREQUENCY RANGE: F1 TO F2 RETRACE RF: OFF F1: Lower frequency of interest F2: Higher frequency of interest LEVELING: INTERNAL POWER: ON RF: ON LEVEL: Maximum leveled power (If UNLEVELED light begins flashing, reduce power until flashing stops.) SLOPE: OFF</p>		<p><u>Network Analyzer</u></p> <p>CHANNEL A ON: Not depressed INPUT: A MEMORY: OFF dB PER DIVISION: 10 REFERENCE dB/dBm: Not depressed OFFSET ZERO: Not depressed</p> <p>CHANNEL B ON: Depressed INPUT: B MEMORY: OFF dB PER DIVISION: 10 REFERENCE dB/dBm: Not depressed (dB indicator lit) OFFSET ZERO: Not depressed THRESHOLD: OFF (fully CCW) TILT: Center of range DISPLAY MODE: REFRESH SMOOTHING: OFF POWER: ON</p>	
<u>Step</u>	<u>Procedure</u>	<u>Display</u>	<u>Notes</u>
2.	Connect Channel B RF Detector to test port of SWR Autotester.	N/A	Normalization should include any adapters that will be used in the measurement, i. e., any component that will appear between the output of the sweeper and the input to the DUT must be included in the normalization process.
3.	Depress Channel B REF POS LOCATE pushbutton switch and adjust SET screwdriver potentiometer to position reference line as shown.		The SET potentiometer is analogous to Vertical Position control on oscilloscope; consequently, initial positioning is arbitrary. Center-screen is used for convenience.
4.	Release REF POS LOCATE pushbutton switch.	N/A	Reference line disappears and Channel B signal returns.

Table 3-1. Display Normalization Procedure (Continued)

Step	Procedure	Display	Notes
5.	Adjust OFFSET control for a 00.0 OFFSET dB display.	N/A	This sets the OFFSET control to its null point.
6.	Adjust ZERO dB SET control to position trace on REF POS LOCATE reference line.		This places the dB reference line coincident with the primary reference line.
7.	Decrease dB PER DIVISION setting until display fills screen. (If necessary, adjust SLOPE for a level trace.)		To allow for full resolution, the 560A has a 50% display overrange capability; consequently, signals can deflect a maximum of 8 divisions from the reference line.
8.	Depress Channel B STORE TRACE push-button switch.		Sweep generator waveform, as modified by system residuals, is stored in Channel B memory.
9.	Depress Channel B SUBTRACT push-button switch.		The straight-line trace is the normalized display. This display occurs because the store signal, which is the same as the input signal, is subtracted from input signal; consequently, the difference is zero.
10.	Remove RF Detector from test port of SWR Autotester.	N/A	N/A

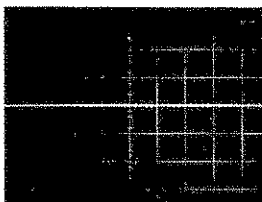
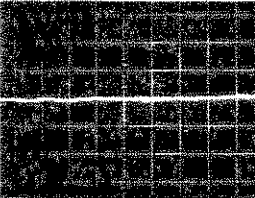
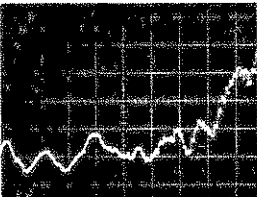
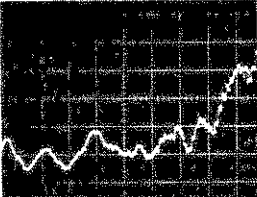
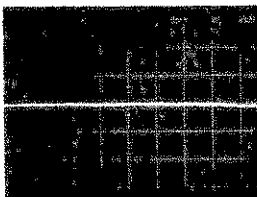
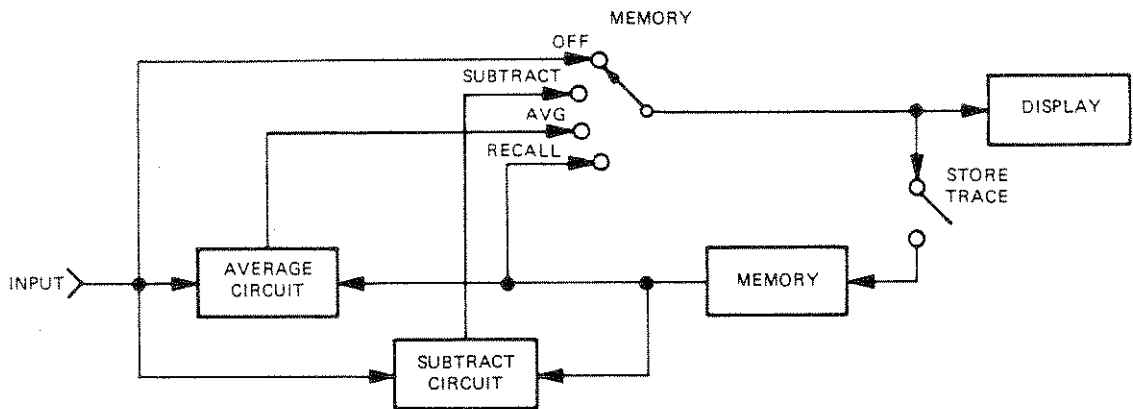

SEQUENCE OF EVENTS	CONNECTED TO TEST PORT OF SWR AUTOTESTER	POSITION OF MEMORY CONTROLS	DISPLAYED ON CRT	STORED IN MEMORY
1	RF DETECTOR	OFF	TRANSMISSION RESIDUALS	UNDEFINED
2	RF DETECTOR	OFF / STORE TRACE	TRANSMISSION RESIDUALS	TRANSMISSION RESIDUALS
3	RF DETECTOR	OFF	TRANSMISSION RESIDUALS	TRANSMISSION RESIDUALS
4	RF DETECTOR	SUBTRACT	TRANSMISSION - TRANSMISSION RESIDUALS (STRAIGHT LINE)	TRANSMISSION RESIDUALS
5	DUT	SUBTRACT	DUT - TRANSMISSION RESIDUALS	TRANSMISSION RESIDUALS

During the Display Normalization Procedure (Table 3-1), the interaction between the display of data on the CRT and the storage of data in memory is summarized in the tabulation of events shown above.

With an RF detector connected to the test port of an SWR Autotester (Figure 3-6) and the MEMORY switch in the OFF position (as shown in the block diagram), transmission residuals are applied only to the display. This is shown by Event 1. When the momentary STORE TRACE switch is activated — Event 2 — the transmission residuals are also stored in memory. When STORE TRACE is released in Event 3, the transmission residuals are in both places: display and memory. In Event 4, the MEMORY switch is changed from OFF to SUBTRACT. The transmission residuals already stored in memory are subtracted from the input transmission residuals. The difference signal, zero, is a straight line that is displayed on the CRT. Event 5 shows the results when a DUT is connected between the RF detector and the SWR Autotester test port. The transmission residuals are now subtracted from the DUT transmission signal, leaving the true DUT characteristics for display. Note: REF POS LOCATE reference line and dB PER DIVISION switch-bank settings can be altered without affecting calibration.

Figure 3-7. Summary of Memory and Display Interaction That Occurred during the Display Normalization Procedure

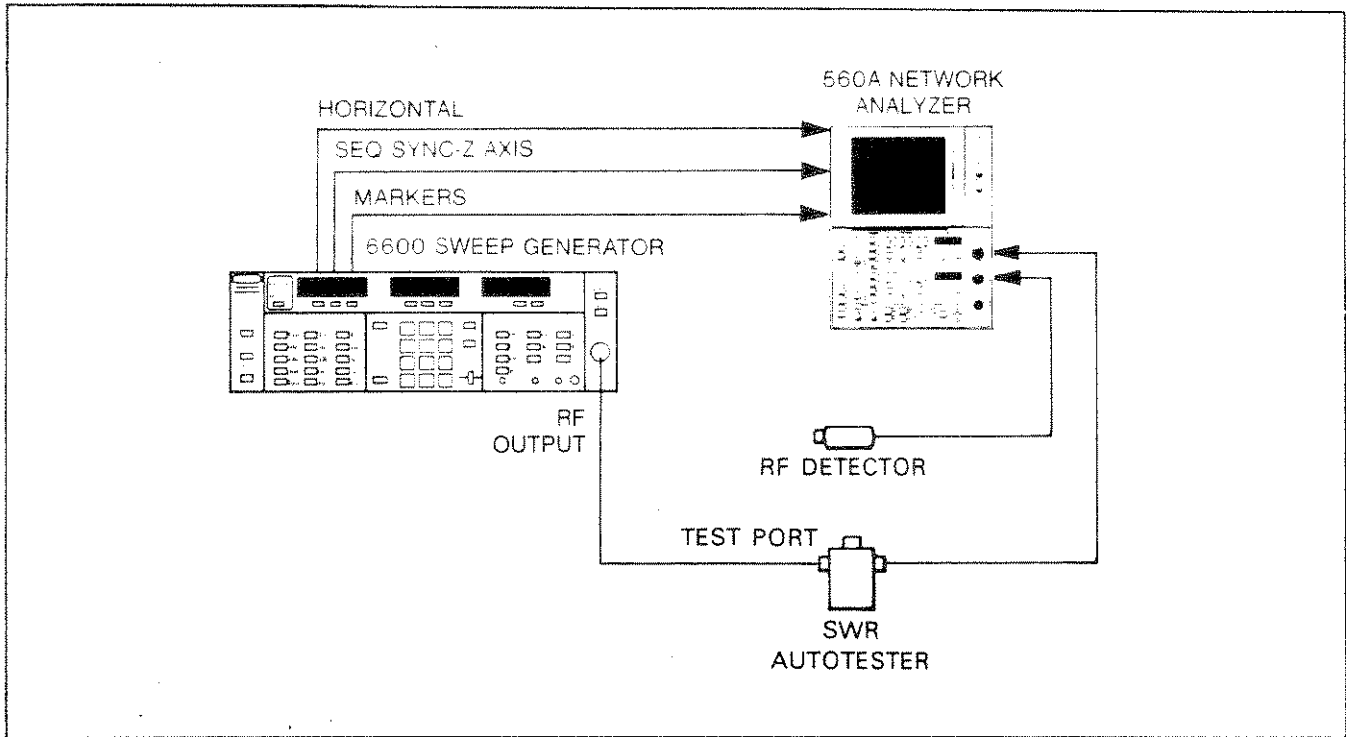

Figure 3-8. Equipment Setup for Return Loss Measurement System Calibration

Table 3-2. Return Loss Measurement Calibration Procedure

<p>1. Set up equipment and perform initial switch positioning.</p>	<p><u>Network Analyzer</u></p>
<p><u>Sweep Generator</u></p>	<p>CHANNEL A: ON INPUT: A MEMORY: OFF dB PER DIVISION: 10 REFERENCE dB/dBm: Not depressed (dB indicator lit) OFFSET ZERO: Not depressed</p>
<p>MARKERS: VIDEO MARKER AMPLITUDE: Fully CCW TRIGGER: AUTO SWEEP TIME: 50 ms FREQUENCY RANGE: F1 TO F2 RETRACE RF: OFF F1: Lower frequency of interest F2: Higher frequency of interest LEVELING: INTERNAL POWER: ON RF: ON LEVEL: Maximum leveled power (If UNLEVELED light begins flashing, reduce power until flashing stops.) SLOPE: OFF</p>	<p>CHANNEL B: OFF INPUT: B MEMORY: OFF dB PER DIVISION: 10 REFERENCE dB/dBm: Not depressed OFFSET ZERO: Not depressed THRESHOLD: OFF (fully CCW) TILT: Center of range DISPLAY MODE: REFRESH SMOOTHING: OFF POWER: ON</p>

Table 3-2. Return Loss Measurement Calibration Procedure (Continued)



Step	Procedure	Display	Notes
2.	Connect open to test port of SWR Autotester	N/A	The fully-reflected sweep generator signal is displayed.
3.	Depress Channel A REF POS LOCATE pushbutton switch; adjust SET screwdriver potentiometer and position reference line as desired.		Reference line placed in this position to observe the downward deflection of the return loss signal.
4.	Release REF POS LOCATE pushbutton switch.	N/A	N/A
5.	Adjust OFFSET control for a 00.0 OFFSET dB display.	N/A	This sets the OFFSET control to its null point.
6.	Adjust ZERO dB SET control to position trace on REF POS LOCATE reference line.		This places the dB reference line coincident with primary reference line.
7.	Decrease dB PER DIVISION setting until display fills screen. Readjust OFFSET control, if necessary, to keep display on screen.		To allow for full resolution, the 560A has a 50% overrange capability; consequently, signals can deflect a maximum of 8 divisions from the reference line in both a positive and a negative direction without undergoing compression.
8.	Depress Channel A STORE TRACE pushbutton switch.		Reflected signal from open is stored in memory.

Table 3-2. Return Loss Measurement Calibration Procedure (Continued)

<u>Step</u>	<u>Procedure</u>	<u>Display</u>	<u>Notes</u>
9.	Remove open; connect short in its place.		Except for phase reversal, this signal is similar to the reflected signal from the open.
10.	Depress Channel A AVG pushbutton switch.		The average of the open/short reflections is displayed.
11.	Depress Channel A STORE TRACE pushbutton switch <u>once</u> and wait for light to extinguish.		Display is showing the result of the open/short average being averaged with the reflections from the short. The average of the open/short reflections is in memory. It is important that STORE TRACE be depressed only once. If depressed a second time, the data on the display will be stored in memory. This will result in erroneous return loss measurements.
12.	Depress Channel A SUBTRACT pushbutton switch.		Display is showing the result of the open/short average having been subtracted from the short.
13.	Remove short from test port. Reflectometer is now ready for return loss measurements.	N/A	N/A

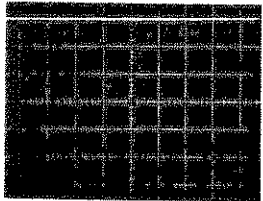
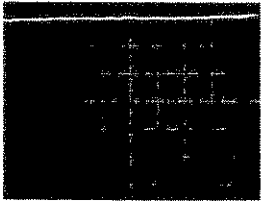
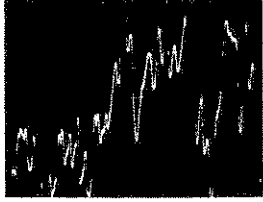
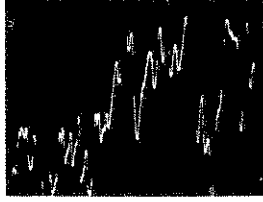
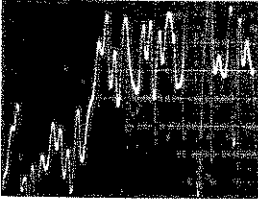
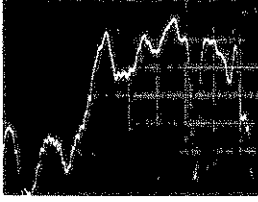
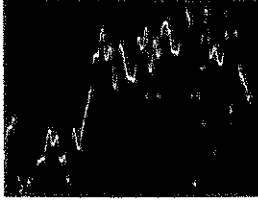

SEQUENCE OF EVENTS	CONNECTED TO TEST PORT OF SWR AUTOTESTER	POSITION OF MEMORY CONTROLS	DISPLAYED ON CRT	STORED IN MEMORY
1	OPEN	OFF	OPEN	UNDEFINED
2	OPEN	OFF / STORE TRACE	OPEN	OPEN
3	SHORT	OFF	SHORT	OPEN
4	SHORT	AVG	$\frac{SHORT + OPEN}{2}$	OPEN
5	SHORT	AVG / STORE TRACE	$\frac{SHORT + OPEN}{2} \Rightarrow \frac{SHORT - \frac{SHORT + OPEN}{2}}{2}$	$\frac{SHORT + OPEN}{2}$
6	SHORT	AVG	$\frac{SHORT + \frac{SHORT - \frac{SHORT + OPEN}{2}}{2}}{2}$	$\frac{SHORT + OPEN}{2}$
7	SHORT	SUBTRACT	$SHORT - \frac{SHORT + OPEN}{2}$	$\frac{SHORT + OPEN}{2}$
8	DEVICE UNDER TEST	SUBTRACT	$DUT - \frac{SHORT + OPEN}{2}$	$\frac{SHORT + OPEN}{2}$

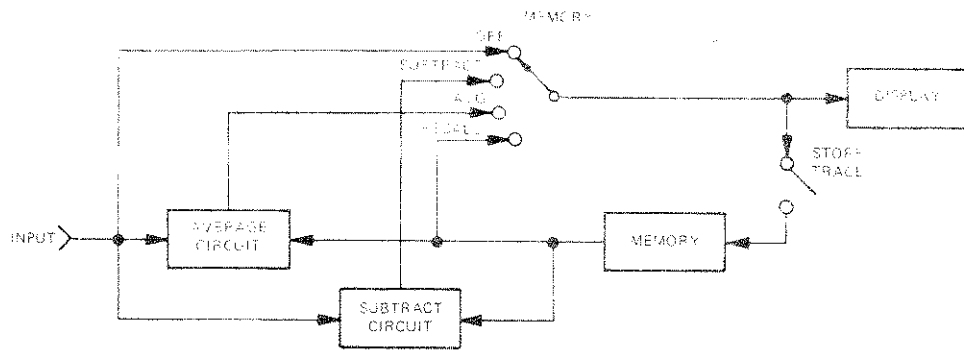
Legend: $AVG = \frac{Input + Memory}{2}$ $SUBTRACT = Input - Memory$ $DUT = Device Under Test$ \Rightarrow Changes To

During the Return Loss Calibration Procedure (Table 3.2) the interaction between the display of data on the CRT and the storage of data in memory is summarized in the tabulation of events shown above.

When the open is connected to the test port of the SWR Autotester (Figure 3-8) and the MEMORY switch is in the OFF position (as shown in the block diagram), the reflection from the open is displayed on the CRT. This is shown in Event 1. When the momentary STORE TRACE switch is activated, Event 2, the reflection from the open is also stored in memory. When the open is replaced by a short in Event 3, the reflection from the short is displayed, however, the reflection from the open is still stored in memory. When the MEMORY switch is changed from OFF to AVG in Event 4, the reflection from the short is averaged with the reflection from the open, and the result displayed on the CRT. In Event 5, STORE TRACE is activated again. The display changes as shown. The average of the open and short changes to the average of the short plus the average of the open and short. When STORE TRACE is released in Event 6, the average of the short plus the average of the open and short is still on the display; however, the average of the open and short is still in memory. When the MEMORY switch is changed from AVG to SUBTRACT in Event 7, the average of the open and short, stored in memory, is subtracted from the short, present at the input, and displayed on the CRT. Event 8 shows the results when a DUT is connected to the test port of the SWR Autotester. The average from the open and short is subtracted from the DUT, leaving the true DUT return loss signal for display. Note: REF POS LOCATE reference line and dB PER DIVISION switch-bank settings can be altered without affecting calibration.

Figure 3-9. Summary of Memory and Display Interaction That Occurred During the Return Loss Measurement Procedure, Table 3-3.

3-3.3 Vertical Scale Factor Controls

Vertical scale factor controls provide each channel (A, B) with either an absolute (dBm) or a relative (dB) power-measuring capability. These controls include the dB PER DIVISION switch-bank; the REF POS LOCATE, REFERENCE dB/dBm, and

OFFSET ZERO pushbutton switches; the OFFSET and ZERO dB SET controls; the REF POS SET screwdriver potentiometer; and the OFFSET dB display. An equipment setup for measuring the output power of the sweep generator is shown in Figure 3-10. Table 3-3 is a procedure for demonstrating the use of the vertical scale factor controls.

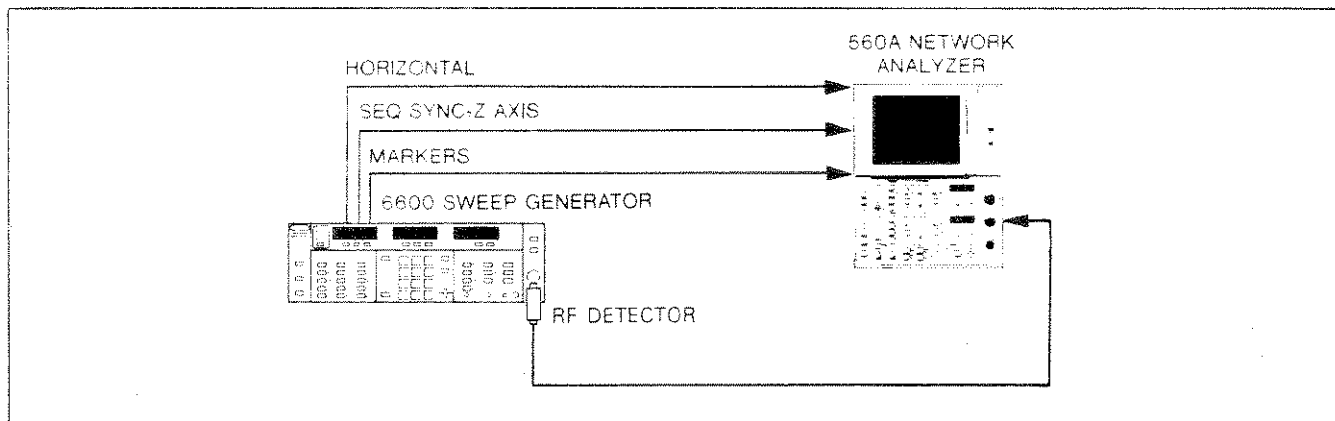

Figure 3-10. Equipment Setup for Measuring Power Output of Sweep Generator RF Plug-In

Table 3-3. Power Measurement Procedure

<p>1. Set up equipment and perform initial switch positioning:</p>	<p><u>Network Analyzer</u></p>
<p><u>Sweep Generator</u></p>	<p>CHANNEL A: OFF INPUT: A MEMORY: OFF dB PER DIVISION: 10 REFERENCE dB/dBm: Not depressed OFFSET ZERO: Not depressed OFFSET dB: 00.00</p>
<p>MARKERS: VIDEO MARKER AMPLITUDE: Fully CCW TRIGGER: AUTO SWEEP TIME: 50 ms FREQUENCY RANGE: F1 TO F2 RETRACE RF: OFF F1: Lower frequency of interest F2: Higher frequency of interest LEVELING: INTERNAL POWER: ON RF: ON LEVEL: Maximum leveled power (If UNLEVELED light begins flashing, reduce power until flashing stops.) SLOPE: OFF</p>	<p>CHANNEL B: ON INPUT: B MEMORY: OFF dB PER DIVISION: 10 REFERENCE dB/dBm: Not depressed (dB indicator lit) OFFSET ZERO: Not depressed OFFSET dB: 00.00 THRESHOLD: OFF (fully CCW) TILT: Center of range DISPLAY MODE: REFRESH SMOOTHING: OFF POWER: ON</p>

Table 3-3. Power Measurement Procedure (Continued)

Step	Procedure	Display	Notes
2.	Depress Channel B REFERENCE dB/dBm pushbutton switch.	N/A	This selects dBm as the reference for future measurements.
3.	Depress and hold Channel B REF POS LOCATE pushbutton switch and adjust SET screwdriver potentiometer to position reference line as shown.		The reference line may be positioned anywhere on the display; the position shown is for convenience only.
4.	Release REF POS LOCATE pushbutton switch.		Reference line is replaced by Channel B signal. Position of this signal in relation to reference line is determined by dB PER DIVISION pushbutton switches.
5.	Adjust OFFSET control to position the mid-frequency point (center) on the trace to the same graticule line that the REF POS LOCATE reference line is positioned to.		The OFFSET dB display indicates the input signal's absolute power level in dBm.
6.	Depress dB PER DIVISION pushbutton switch labeled .5.		Trace expands about the reference line.

Table 3-3. Power Measurement Procedure (Continued)

Step	Procedure	Display	Notes
7.	Depress REFERENCE dB/dBm pushbutton switch.	N/A	Trace may be off-screen it is displaced from the REF POS LOCATE reference line by the ZERO dB SET control.
8.	Push and turn ZERO dB SET control to position trace near center screen.		(To find trace more easily, reduce dB PER DIVISION resolution to 10. After positioning trace, return to .5.) This step and the two that follow demonstrate the relationship between this control and the REF POS LOCATE reference line.
9.	Depress and hold REF POS LOCATE pushbutton switch and adjust SET potentiometer to position reference line on center graticule line.		Trace is replaced by reference line.
10.	Release REF POS LOCATE pushbutton switch.		Trace reappears near top of screen. This shows that the reference line for dB measurements is offset from the reference line for dBm measurements by the positioning of the ZERO dB SET control.
11.	Depress OFFSET ZERO pushbutton switch.	N/A	OFFSET dB display indicates ± 00.0 .

Table 3-3. Power Measurement Procedure (Continued)

Step	Procedure	Display	Notes
12.	Push and turn ZERO dB SET control to position low-frequency end of trace on reference line.		This step and the three that follow present a technique for "adding and subtracting" in dB using the OFFSET dB display. In this technique, ZERO dB SET is used to establish a 00.0 dB reference at any desired point on the trace. After establishing this point, OFFSET is used to measure to any other point on the waveform; the measurement value is indicated on the OFFSET dB display.
13.	Depress OFFSET ZERO pushbutton switch.	N/A	Trace disappears from screen.
14.	Adjust OFFSET control to position low-frequency end of trace on reference line.		(As noted in Step 8, it will be easier to find trace if dB PER DIVISION resolution is temporarily reduced to 10.) This adjustment of the OFFSET control establishes a 0 dB reference at the low-frequency end of the trace.
15.	Adjust OFFSET control to position high-frequency end of trace on reference line.		The dB value indicated on the OFFSET dB display is the variation in power from the low end to the high end of the frequency band. Typically, this value is less than 1.0 dB.
End of Procedure			

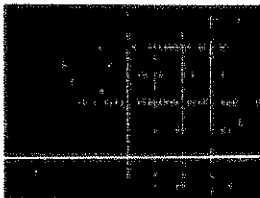
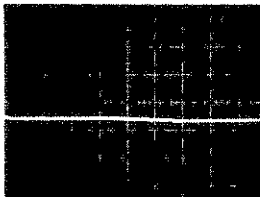
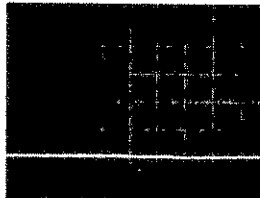
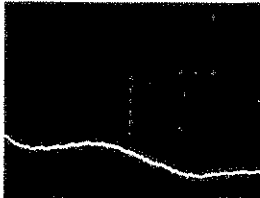
3-3.4 Marker Controls

Marker controls provide control over sweep generator markers that appear on the 560A CRT. If the WILTRON 6600(A) Series sweeper provides the markers, threshold control is provided by the front panel OFF-THRESHOLD control. If the Hewlett-Packard Model 8620 provides the markers, markers appear on screen when the OFF-THRESHOLD control is moved from the OFF (detent) position. In the case of either sweep generator, markers are fixed in amplitude. The THRESHOLD control, when used, determines only the threshold voltage at which internal marker circuitry responds to external marker inputs. The front panel TILT control provides up to plus or minus (\pm) 45 degrees of tilt for displayed markers. This tilting of markers is very helpful in identifying markers where the displayed signal has steep skirts, e. g. measurements of an electronic filter (Figure 3-11). Additionally, when the 6600(A) Series sweeper with its three different types of markers is used, the 560A response is different for each marker-type. This response is described below.

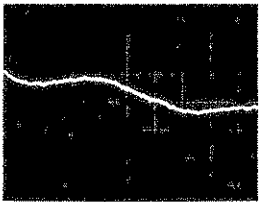
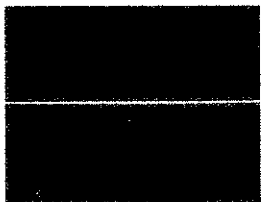
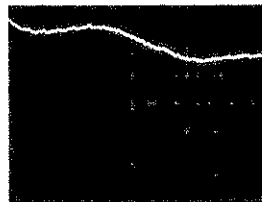
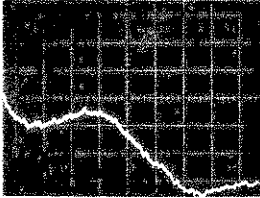
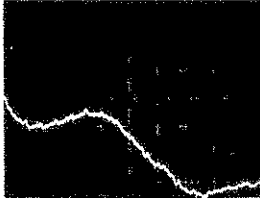
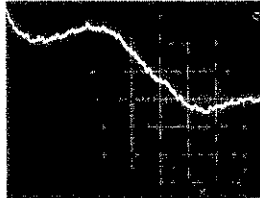
- a. INTENSITY Markers. The 560A responds to intensity markers only in the REAL TIME display mode. Markers appear as an intensified dot; see page 3-5, (9).
- b. VIDEO Markers. The 560A responds to video markers in REAL TIME or REFRESH display modes. Markers appear as a VIDEO pulse; they respond to both THRESHOLD and TILT controls.

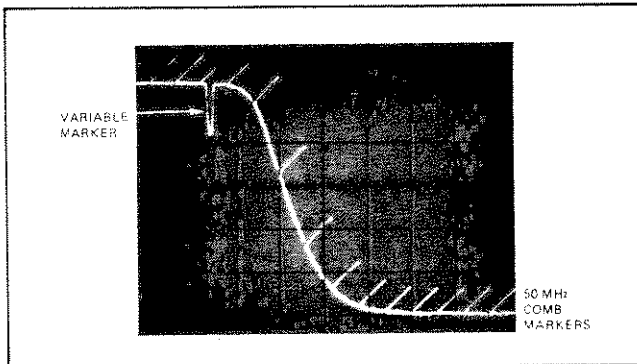

Figure 3-11. Bandpass Filter Measurement Showing Marker Tilting

- c. RF Markers. The 560A responds to RF markers in both REAL TIME and REFRESH display modes. Markers appear as a notch in the displayed trace, and, since the markers modulate the RF signal, they do not respond to either MARKER TILT or THRESHOLD control.

CAUTION

Marker data could be altered, or destroyed, if the storage memory is used to store a signal containing marker information. Since the RF marker pips modulate the signal, they are stored along with the signal; consequently, when the stored signal is recalled and either averaged with (MEMORY AVG depressed) or subtracted from (MEMORY SUBTRACT depressed) the input markers, the stored markers are also averaged with or subtracted from the input markers.

3-3.5 Display Mode Controls

Display mode controls provide for five display modes: REAL TIME, REFRESH, REFRESH HOLD, X-Y PLOT-REFRESH, and X-Y PLOT-REAL TIME. These modes are described below.

- a. REAL TIME Mode. In this mode, the horizontal sweep ramp from the sweep generator provides drive for the CRT X-axis display; the input data from the logarithmic amplifier provides drive for the Y-axis display. The horizontal display time is determined by the sweep generator sweep time control – SWEEP TIME on the WILTRON 6600(A) Series or TIME-SECONDS on the HP 8620C.
- b. REFRESH Mode. In this mode, an internally generated 14 ms sweep ramp provides drive for the CRT X-axis display. An internal memory, known as refresh memory, provides drive for the

CRT Y-axis display. The Y-axis data is effectively read into refresh memory in real time, and read out of refresh memory in refresh (14 ms) time. The data is, therefore, proportional to sweep generator frequency. The refresh capability provides a horizontal display time proportional to, but independent of, the sweep generator's sweep time control. This provides for a non-flickering display.

- c. REFRESH HOLD Mode. In this mode, the refresh (14 ms) ramp provides drive for the CRT X-axis display; refresh memory provides drive for the Y-axis display. In REFRESH HOLD, the display data is being read out of the refresh memory and applied to the display at a 14-ms rate; however, the refresh memory is prevented from having new data written into it, thereby allowing only previously-stored data to be made available for display. The indicator associated with the REFRESH HOLD switch remains lit while this mode is activated. This mode is useful when the display is to be photographed.
- d. X-Y PLOT-REFRESH Mode. In this mode, X-axis and Y-axis voltages come from the refresh circuitry. The 14 ms refresh ramp is slowed to 30 s and applied to the HORIZONTAL OUTPUT connector; the stored data in the refresh memory is applied to the VERTICAL OUTPUT connector. As described for REFRESH HOLD, above, new data is prevented from being written into the refresh memory during this mode. This mode is entered into when the X-Y PLOT pushbutton switch is depressed while the REFRESH pushbutton switch is depressed. Approximately one second after the 30 s sweep begins, the pen-lift relay causes the X-Y plotter's pen to drop. A delay of 500 ms prevents an erroneous line from being traced on the X-Y plotter's paper. In dual channel operation (both CHANNEL ON pushbutton switches depressed), the channels are plotted sequentially: first Channel A then Channel B. A one-second delay is provided be-

tween these two plots. Also, in either single or dual channel operation, the plot may be aborted by depressing X-Y PLOT a second time. For single channel operation, the indicator associated with the X-Y PLOT switch remains lit until the plot is completed; for dual channel operation, the indicator remains lit until both plots are completed. When the indicator goes out, the REFRESH sweep returns to the display. A procedure for setting the X and Y parameters on the recorder in preparation for making an X-Y plot is provided in Table 3-4; the equipment setup is shown in Figure 3-12.

- e. X-Y PLOT-REAL TIME Mode. This mode is entered when the X-Y PLOT pushbutton switch is depressed while in the REAL TIME display mode. Approximately 500 ms after the sweep generator begins a new horizontal forward sweep, the pen-lift relay causes the X-Y plotter's pen to drop. This delay prevents an erroneous line from being traced on the X-Y plotter's paper. The delay allows the X-Y plotter time in which to move the pen from its rest position to the position where the plot actually begins. In dual channel operation (both CHANNEL ON pushbuttons depressed), the channels are plotted sequentially: first Channel A then Channel B. A delay is provided between these two plots. For single channel operation, the indicator associated with the X-Y PLOT switch remains lit until the plot is completed; for dual channel operation, the indicator remains lit until both plots are completed. The intended sweep generator mode when using the X-Y plot mode is triggered sweep. With a triggered sweep, the X-Y plot circuitry is armed when the mode is entered, but the sweep does not begin until the sweep generator's trigger switch is activated.

3-3.6 Smoothing Control

Smoothing control provides two levels of filtering to improve signal response at low signal levels. This control is a three-posi-

tion (OFF, MIN, MAX) switch. When the SMOOTHING switch is depressed to light the MIN indicator, the first level of filtering is activated. With SMOOTHING-MIN selected, input signals below -30 dBm receive filtering. Input signals above -30 dBm are not filtered. When the SMOOTHING switch is depressed to light the MAX indicator, the second level of filtering is selected. With SMOOTHING-MAX selected, input signals below -30 dBm receive fil-

tering - first-level filtering from -30 dBm to -40 dBm and second-level filtering below -40 dBm. Input signals above -30 dBm receive no filtering. Filtering greatly improves noise-reduction at low signal levels; however, filtering slows the response time of the logarithmic amplifier. Consequently, if SMOOTHING-MIN or -MAX is selected, the sweep time of the sweep generator, should be reduced to ensure faithful reproduction of input signals.

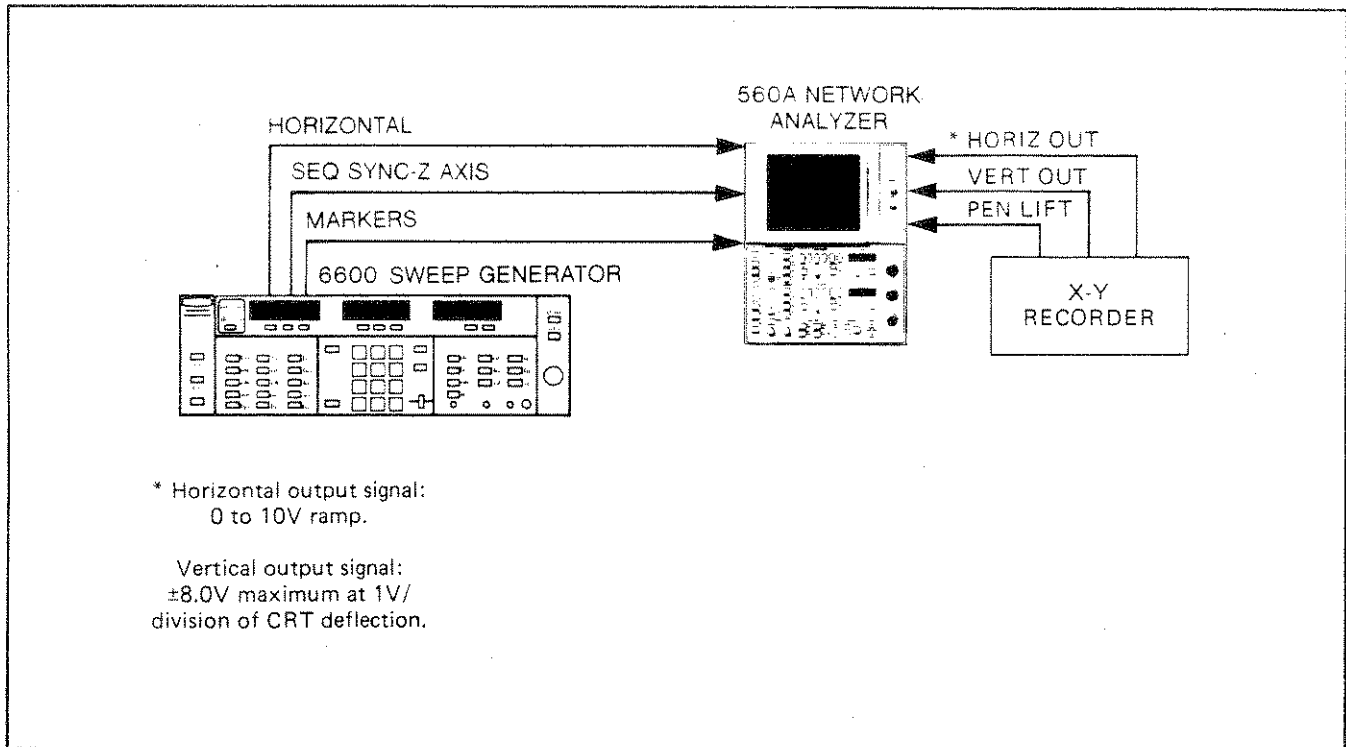

Figure 3-12. Equipment Setup for X-Y Recorder Setup

Table 3-4. X-Y Recorder Setup Procedure

<p>1. Set up equipment and perform initial switch positioning:</p> <p><u>Sweep Generator</u></p> <p>MARKERS: VIDEO MARKER AMPLITUDE: Fully CCW TRIGGER: AUTO SWEEP TIME: 50 ms FREQUENCY RANGE: F1 TO F2 RETRACE RF: OFF F1: Lower frequency of interest F2: Higher frequency of interest LEVELING: INTERNAL POWER: ON RF: ON LEVEL: Maximum leveled power (UNLEVELED light may be on; disregard it.) SLOPE: N/A</p>		<p><u>Network Analyzer</u></p> <p>CHANNEL A: ON INPUT: A MEMORY: OFF dB PER DIVISION: 10 REFERENCE dB/dEm: Depressed (dBm indicator lit) OFFSET ZERO: Not depressed OFFSET dB: 00.0</p> <p>CHANNEL B: OFF INPUT: B MEMORY: OFF dB PER DIVISION: 10 REFERENCE dB/dBm: Depressed OFFSET ZERO: Not depressed THRESHOLD: OFF (fully CCW) TILT: Center of range DISPLAY MODE: REAL TIME SMOOTHING: OFF OUTPUT MODE (rear panel): RCDR POWER: ON</p>
Step	Procedure	Results
2	On 560A, lightly depress A-R or R pushbutton switch so that all three INPUT switches are released (not depressed).	Trace is present on CRT.
3	On 560A, adjust Channel A SET screwdriver potentiometer to center trace on CRT.	Trace is centered.
4	On 560A, check that HORIZ START and STOP screwdriver potentiometers are properly adjusted; refer to paragraph 2-3.3.	Refer to paragraph 2-3.3.
5	On 6600(A), press MANUAL SWEEP button.	Beam dot appears on 560A CRT.
6	On 560A, position rear panel OUTPUT MODE switch to CRT.	N/A
7	On 6600(A), rotate MANUAL SWEEP control fully counterclockwise.	Beam dot on 560A CRT moves to left graticule edge.
8	On recorder, adjust horizontal (X) Offset (or Position) control to position pen over left edge of plot graph. Press down on pen and make contact with paper.	Ink dot superimposed on left edge of plot graph.

Table 3-4. X-Y Recorder Setup Procedure (Continued)

Step	Procedure	Results
9	On 6600(A), rotate MANUAL SWEEP control fully clockwise.	Beam dot on 560A CRT moves from left to right graticule edge.
10	<p>On recorder, press down on pen and ensure that pen is coincident with right edge of plot graph. If pen not aligned with right edge, adjust horizontal Gain (or Sensitivity) control.</p> <p style="text-align: center;"><u>NOTE</u></p> <p>If Gain (or Sensitivity) control is adjusted, it may be necessary to recheck adjustment of Offset (or Position) control.</p>	Ink dot superimposed on right edge of plot graph.
11	On 6600(A), rotate MANUAL SWEEP control until beam dot is centered on 560A display.	Beam dot centered on 560A CRT.
12	On recorder, adjust vertical (Y) Offset (or Position) control to position pen on reference line for type of measurement being plotted (i. e., top of graph if return loss being plotted or bottom of graph if transmission gain being plotted). Press down on pen and make contact with paper.	Ink dot positioned on reference line of plot graph.
13	If reference line on recorder is positioned at top of graph (return loss), adjust OFFSET control in -10 dBm increments, as indicated on OFFSET dB display, and observe recorder pen movement.	Recorder pen should deflect 1 division for each 10 dBm of OFFSET control movement.
14	If reference line on recorder is positioned at bottom of graph (transmission gain), adjust OFFSET control in +10 dBm increments, as indicated on OFFSET dB display, and observe recorder pen movement.	Recorder pen should deflect 1 division for each 10 dBm of OFFSET control movement.
15	<p>If recorder pen movement not as described in steps 13 or 14, above, adjust recorder vertical Gain (or Sensitivity) control.</p> <p style="text-align: center;"><u>NOTE</u></p> <p>If Gain (or Sensitivity) control is adjusted, it may be necessary to recheck adjustment of Offset (or Position) control.</p>	N/A

Table 3-4. X-Y Recorder Setup Procedure (Continued)

Step	Procedure	Results
16	On 560A, position rear panel OUTPUT MODE switch to RCDR.	N/A
17	On 6600(A), press AUTO button.	N/A
18	On 560A, depress desired Channel A INPUT switch (A, A-R, R).	N/A
	END OF PROCEDURE.	

3-4. OPERATIONAL CHECKOUT

panel controls as follows:

Operational checkout of the Model 560A Scalar Network Analyzer consists of evaluating the operation of front panel controls and verifying the operation of microwave input components (SWR Autotester and RF Detector). Operational checkout requires the use of a sweep generator to provide control voltages and a microwave test signal; refer to paragraph 2-3.2 for sweep generator requirements.

Front Panel

CHANNEL A

CHANNEL A ON: Not depressed
 INPUT: R
 MEMORY: OFF
 dB PER DIVISION: 10
 REFERENCE dB/dBm: Not depressed
 OFFSET ZERO: Not depressed
 SET (screwdriver pot): Center of range

3-4.1 Preliminary Checks

CHANNEL B

CHANNEL B ON: Not depressed
 INPUT: R
 MEMORY: OFF
 dB PER DIVISION: 10
 REFERENCE dB/dBm: Not depressed
 OFFSET ZERO: Not depressed
 SET (screwdriver pot.): Center of range

The following steps must be completed before beginning the operational checkout in Table 3-5. These steps include configuring the 560A for proper line voltage, interconnecting the 560A with sweep generator, energizing sweep generator, and positioning the 560A front and rear panel controls.

THRESHOLD: OFF (fully CCW until control clicks)
 TILT: Center of range
 DISPLAY MODE: REAL TIME
 POWER: Not depressed

- a. Configure for Line Voltage. Configure the 560A for correct line voltage per paragraph 2-3.1.
- b. Interconnect Sweep Generator. Interconnect the 560A sweep generator per paragraph 2-3.2.
- c. Energize Sweep Generator. Turn on and position sweep generator controls for a 50 ms sweep. Set RF output attenuation control to provide maximum output.
- d. Set Controls. Set the 560A front and rear

Rear Panel

LOW LEVEL CAL: NORM
 OUTPUT MODE: CRT

3-4.2 Operational Checkout and Troubleshooting Procedure

Operational checkout and troubleshooting instructions are presented in Table 3-5.

Table 3-5. Operational Checkout and Troubleshooting Using Front Panel Controls and Potentiometers

Step	Control	Procedure	Normal Indication	If Indication Abnormal
1	POWER	Depress. <u>NOTE</u> With both channel ON switches off (not depressed), 560A defaults to Channel A operation.	a. ON indicator lights. b. SMOOTHING OFF indicator lights. c. Channel A dB indicator lights. d. Channel A OFFSET dB display lights.	a. If ON indicator does not light but indicators in Steps 1b, c, and d do light, then ON indicator is faulty. If no indicators light, refer to Figure 7-2. b. If MAX or MIN indicators light, A2 PCB Power-On Reset (PON) circuit is faulty. Refer to paragraphs 7-7.13 and 7-7.23. c. A1 PCB faulty; refer to paragraph 7-7.1. d. A1 PCB faulty; refer to paragraph 7-7.1.
Channel A Checkout				
2	CHANNEL A ON	Depress.	No change from Step 1.	N/A
3	REFERENCE dB/dBm	Depress.	dB indicator goes out and dBm indicator lights.	A1 PCB faulty. Refer to paragraph 7-7.1.
4	OFFSET	Rotate throughout range, then set control to -30.0	a. OFFSET dB display varies $>\pm 65.0$ dB. b. Horizontal trace is on the display.	a. A1 PCB faulty. Refer to paragraph 7-7.1. b. Refer to Figure 7-3.

Table 3-5. Operational Checkout and Troubleshooting Using Front Panel Controls and Potentiometers (Continued)

Step	Control	Procedure	Normal Indication	If Indication Abnormal
5	OFFSET ZERO	Depress.	OFFSET dB indicates ± 00.0 ; trace deflects downward near bottom of CRT or off-screen.	A1 PCB faulty; refer to paragraph 7-7.1.
6	OFFSET ZERO	Depress.	OFFSET dB display indicates -30.0 and trace returns to near center of CRT.	A1 PCB faulty; refer to paragraph 7-7.1.
7	OFFSET	Rotate counterclockwise (CCW) to obtain 00.0 readout on OFFSET dB display.	OFFSET dB indicates ± 00.0 ; trace deflects downward near bottom of CRT or off-screen.	A1 PCB faulty; refer to paragraph 7-7.1.
8	REF POS LOCATE	Depress and hold.	Trace appears on or near center of CRT.	Refer to Figure 7-4.
9	SET potentiometer	Rotate throughout range.	Trace moves vertically on display.	Refer to Figure 7-5.
10	SET potentiometer	Adjust so that trace is centered on display.	Trace is centered on display.	N/A
11	REF POS LOCATE	Release.	Trace deflects downward near bottom of CRT or off-screen.	N/A
12	OFFSET	Rotate clockwise (CW) to obtain -30.0 on OFFSET dB display.	Trace returns to near center of CRT and OFFSET dB display indicates -30.0 .	N/A
13	HORIZ START	Check that potentiometer is properly adjusted so that input horizontal sweep ramp starts at 0 volts (paragraph 2-3.3). Determine proper adjustment as follows:	N/A	N/A

Table 3-5. Operational Checkout and Troubleshooting Using Front Panel Controls and Potentiometers (Continued)

Step	Control	Procedure	Normal Indication	If Indication Abnormal
13	(Cont'd)	<p>a. Observe CRT and rotate START potentiometer CW until left hand trace end begins to move right; stop CW rotation.</p> <p>b. Rotate START potentiometer CCW until trace-end stops moving left and dot begins to intensify; stop CCW rotation.</p>	<p>N/A</p> <p>Trace movement to the left stops on or within 1 minor division from left edge of graticule.</p>	<p>a. If trace-end dot fails to intensify when START is rotated fully CCW or fails to deintensify when START is rotated fully CW, refer to Figure 7-6.</p> <p>b. If <u>intensified</u> trace-end dot fails to extend to graticule left edge, adjust CRT mainframe HORIZ POSITION potentiometer, refer to paragraph 3-4.3.</p>
14	HORIZ STOP	Check that potentiometer is properly adjusted so that input horizontal sweep ramp stops at 10 volts. Proper adjustment is determined by observing CRT and rotating STOP potentiometer CW until trace movement to the right stops and trace-end dot begins to intensify.	Trace movement to the right stops on or within 1 minor division from right edge of graticule.	Refer to Figure 7-7.
15	None	Check that trace is level.	Trace is level.	Adjust CRT mainframe TRACE ROTATE potentiometer. Refer to paragraph 3-4.3 for adjustment procedure.
16	None	Connect 560-7 series RF Detector between front panel R connector and RF OUTPUT on sweep generator.	Trace deflects approximately 3 divisions upward from centerline.	RF detector, detector connector, or 560A input connector faulty.

Table 3-5. Operational Checkout and Troubleshooting Using Front Panel Controls and Potentiometers (Continued)

Step	Control	Procedure	Normal Indication	If Indication Abnormal
17	OFFSET	Rotate control CCW to center trace on display.	Trace centered on display.	N/A
18	SLOPE (on sweep generator)	Adjust control for a level trace.	Level trace centered on display.	Sweep generator faulty.
19	INPUT A-R	Depress.	a. Trace deflects either near bottom or off CRT. b. dBm indicator begins flashing.	a. N/A b. A2 PCB faulty. Refer to paragraph 7-7.3.
20	INPUT A	Depress.	Trace remains unchanged, but dBm indicator stops flashing.	N/A
21	None	Disconnect RF detector from R connector and connect to A connector.	Trace on or near center of CRT.	Refer to Figure 7-8.
22	SLOPE (on sweep generator)	Rotate fully CW.	Trace on CRT slopes downwards from left to right.	Sweep generator faulty.
23	dB PER DIVISION	Depress each switch in turn and observe that displayed trace changes in slope; leave .5 switch depressed.	Trace changes in slope.	A1 PCB faulty. Refer to paragraph 7-7.1.
24	SLOPE (on sweep generator)	While observing CRT, adjust control for a trace slope of 4 divisions.	Trace slopes 4 divisions downwards from left to right.	N/A
25	STORE TRACE	Depress and release. When red indicator located	Trace as specified in Step 24 appears on CRT.	a. If red LED fails to light, A1 PCB is faulty. Refer

Table 3-5. Operational Checkout and Troubleshooting Using Front Panel Controls and Potentiometers (Continued)

Step	Control	Procedure	Normal Indication	If Indication Abnormal
25	(Cont'd)	above switch goes out, trace is stored. <u>NOTE</u> The length of time this LED remains lit depends upon sweep speed.		to paragraph 7-7.1. b. If red LED fails to go out, A2 PCB is faulty. Refer to paragraph 7-7.18.
26	None	On sweep generator, position RF output switch to OFF.	Trace disappears from CRT.	Troubleshoot sweep generator.
27	RECALL	Depress.	Trace as specified in Step 24 reappears on CRT and dBm indicator begins flashing.	a. If straight-line trace appears on CRT or if dBm indicator fails to flash, A1 PCB faulty. Refer to paragraph 7-7.1. b. If a trace does not appear on CRT, or if CRT displays random lines, A2 is faulty. Refer to paragraphs 7-7.4, 7-7.5 and 7-7.18.
28	MEMORY OFF	Depress.	Trace disappears from CRT and dBm indicator stops flashing.	N/A
29	None	On sweep generator, position RF output switch to ON.	Trace as specified in Step 24 reappears on CRT.	N/A
30	SUBTRACT	Depress.	Trace changes to straight-line trace and dBm indicator begins flashing.	A1 PCB faulty. Refer to paragraph 7-7.1.

Table 3-5. Operational Checkout and Troubleshooting Using Front Panel Controls and Potentiometers (Continued)

Step	Control	Procedure	Normal Indication	If Indication Abnormal
31	STORE TRACE	Depress and Release.	Trace as specified in Step 24 reappears on CRT.	A1 PCB faulty. Refer to paragraph 7-7.1.
32	AVG	Depress.	Trace slopes downwards 2 divisions from left to right.	A1 PCB faulty. Refer to paragraph 7-7.1.
33	MEMORY OFF	Depress.	Trace as specified in Step 24 reappears on CRT.	N/A
34	SLOPE (on sweep generator)	While observing CRT, rotate control CCW until trace is level.	Trace is level.	N/A
35	REFERENCE dB/dBm	Depress	a. dBm indicator goes out; dB indicator lights. b. Trace may shift vertically or may disappear entirely.	A1 PCB faulty. Refer to paragraph 7-7.1.
36	ZERO dB SET	Push and turn to move trace onto display. If trace already present on display, rotate control and verify that trace moves vertically. Increase to 10 dB PER DIVISION as necessary.	Trace moves vertically on CRT.	A1 PCB faulty. Refer to paragraph 7-7.1.
37	ZERO dB SET	Rotate control (push and turn) to center trace on CRT.	Trace centered on CRT.	A1 PCB faulty. Refer to paragraph 7-7.1.
Channel B Checkout				
38	CHANNEL B ON	Depress.	a. Channel B dB indicator lights. b. Channel B OFFSET dB display lights.	A1 PCB faulty. Refer to paragraph 7-7.1.

Table 3-5. Operational Checkout and Troubleshooting Using Front Panel Controls and Potentiometers (Continued)

Step	Control	Procedure	Normal Indication	If Indication Abnormal
39	CHANNEL A ON	Depress.	Channel A OFFSET dB display and dB indicator goes out.	N/A
40	REFERENCE dB/dBm	Depress.	dB indicator goes out and dBm indicator lights.	A1 PCB faulty. Refer to paragraph 7-7.1.
41	OFFSET	Rotate throughout range, then leave control set at -30.0.	a. OFFSET dB display varies $>\pm 65$ dB. b. Horizontal trace is on the display.	a. A1 PCB faulty. Refer to paragraph 7-7.1. b. Refer to Figure 7-9.
42	OFFSET ZERO	Depress.	OFFSET dB display indicates +00.0; trace deflects downward near bottom of CRT or off-screen.	A1 PCB faulty. Refer to paragraph 7-7.1.
43	OFFSET ZERO	Depress.	OFFSET dB display indicates -30.0 and trace moves back to center of CRT.	A1 PCB faulty. Refer to paragraph 7-7.1.
44	OFFSET	Rotate CCW to obtain +00.0 readout on OFFSET dB display.	OFFSET dB indicates +00.0; trace deflects downwards near bottom of CRT or off-screen.	A1 PCB faulty. Refer to paragraph 7-7.1.
45	REF POS LOCATE	Depress and hold.	Trace moves to center of CRT.	Refer to Figure 7-10.
46	SET potentiometer	Rotate throughout range.	Trace moves vertically on CRT.	Refer to Figure 7-11.
47	SET potentiometer	Center trace on CRT.	Trace is centered on display.	N/A
48	REF POS LOCATE	Release.	Trace deflects downwards near bottom of CRT or off-screen.	N/A

Table 3-5. Operational Checkout and Troubleshooting Using Front Panel Controls and Potentiometers (Continued)

Step	Control	Procedure	Normal Indication	If Indication Abnormal
49	OFFSET	Rotate CW to obtain -30.0 on OFFSET dB display.	Trace returns to near center of CRT and OFFSET dB display indicates -30.0.	N/A
50	None	Disconnect RF detector from A connector and connect to R connector.	Trace deflects approximately 3 divisions upwards from centerline.	N/A
51	OFFSET	Rotate control CCW to center trace on CRT.	Leveled trace centered on CRT.	N/A
52	INPUT B-R	Depress.	a. Trace deflects downwards near bottom of CRT or off-screen. b. dBm indicator begins flashing.	N/A
53	INPUT B	Depress.	Trace remains unchanged, but dBm indicator stops flashing.	N/A
54	None	Disconnect RF detector from R connector and connect to B connector.	Trace on or near center of CRT.	Refer to Figure 7-12.
55	SLOPE (on sweep generator)	Rotate fully CW.	Trace on CRT slopes downwards from left to right.	N/A
56	dB PER DIVISION	Depress each switch in turn and observe that displayed trace changes in slope; leave .5 switch depressed.	Trace changes in slope.	A1 PCB faulty. Refer to paragraph 7-7. 1.
57	SLOPE (on sweep generator)	While observing CRT, adjust control for a trace slope of 4 divisions.	Trace slopes downwards 4 divisions from left to right.	N/A

Table 3-5. Operational Checkout and Troubleshooting Using Front Panel Controls and Potentiometers (Continued)

Step	Control	Procedure	Normal Indication	If Indication Abnormal
58	STORE TRACE	Depress and release. When red indicator located directly above switch goes out, trace is stored.	Trace is as specified in Step 57.	<p>a. If red LED fails to light, A1 PCB is faulty. Refer to paragraph 7-7.1.</p> <p>b. If red LED fails to go out, A2 PCB is faulty. Refer to paragraph 7-7.18.</p>
59	None	On sweep generator, position RF output switch to OFF.	Trace disappears from CRT.	N/A
60	RECALL	Depress.	Trace as specified in Step 57 reappears on CRT and dBm indicator begins flashing.	<p>a. If straight-line trace appears on CRT or if dBm indicator fails to flash, A1 PCB faulty. Refer to paragraph 7-7.1.</p> <p>b. If trace does not appear on CRT or if CRT displays random lines, A2 PCB faulty. Refer to paragraphs 7-7.4, 7-7.5 and 7-7.18.</p>
61	MEMORY OFF	Depress.	Trace disappears from CRT and dBm indicator stops flashing.	N/A
62	None	On sweep generator, position RF output switch to ON.	Trace as specified in Step 57 reappears.	N/A
63	SUBTRACT	Depress.	Trace changes to straight-line trace and dBm indicator begins flashing.	A1 PCB faulty. Refer to paragraph 7-7.1.

Table 3-5. Operational Checkout and Troubleshooting Using Front Panel Controls and Potentiometers (Continued)

Step	Control	Procedure	Normal Indication	If Indication Abnormal
64	STORE TRACE	Depress and Release.	Trace as specified in Step 57 reappears on CRT.	A1 PCB faulty. Refer to paragraph 7-7.1.
65	AVG	Depress.	Trace slopes downwards 2 divisions from left to right.	A1 PCB faulty. Refer to paragraph 7-7.1.
66	MEMORY OFF	Depress.	Trace as specified in Step 57 reappears on CRT.	N/A
67	SLOPE (on sweep generator)	While observing 560A CRT, rotate control CCW until trace is level.	Trace is level.	N/A
68	REFERENCE dB/dBm;	Depress.	a. dBm indicator goes out/ dB indicator lights. b. Trace may shift vertically or it may disappear entirely.	N/A
69	ZERO dB SET	Push and turn to move trace onto display. If trace already present on display, rotate control and verify that trace moves vertically. (Increase to 10 dB PER DIVISION as necessary.)	Trace moves vertically on CRT.	A1 PCB faulty. Refer to paragraph 7-7.1.
70	ZERO dB SET	Rotate control (push and turn) to center trace on CRT.	Trace centered on CRT.	A1 PCB faulty. Refer to paragraph 7-7.1.

Table 3-5. Operational Checkout and Troubleshooting Using Front Panel Controls and Potentiometers (Continued)

Step	Control	Procedure	Normal Indication	If Indication Abnormal
Markers, Display Mode, and Smoothing Checkout				
71	None	On sweep generator, position marker control(s) to provide video marker near center of band (on 6600(A) MARKER AMPLITUDE must be maximum).	N/A	N/A
72	THRESHOLD	<p>a. If WILTRON 6600(A) series sweeper is used, rotate control CW until video marker appears.</p> <p>b. If HP 8620 sweeper is used, rotate control CW until it clicks (<u>on</u> position).</p>	<p>a. Marker pulse positioned near center of trace.</p> <p>b. Marker pulse positioned near center of trace.</p>	<p>a. Refer to Figure 7-13.</p> <p>b. Refer to Figure 7-14.</p>
73	TILT	Refer to page 3-5, (9).	Marker tilts $\pm 45^\circ$.	A1 PCB or wiring between A1 and A2 faulty.
74	THRESHOLD	Rotate CCW to OFF (detent)	Marker pulse disappears.	N/A
75	REFRESH	Depress.	Real time display replaced by refresh display.	Refer to Figure 7-15.
76	REFRESH HOLD	Depress.	Display freezes and REFRESH HOLD indicator lights.	<p>a. If indicator does not light, A1 PCB faulty.</p> <p>b. If display does not freeze, A2 PCB or wiring between A1 and A2 faulty.</p>

Table 3-5. Operational Checkout and Troubleshooting Using Front Panel Controls and Potentiometers (Continued)

Step	Control	Procedure	Normal Indication	If Indication Abnormal
77	REFRESH HOLD	Depress.	Refresh display returns and REFRESH HOLD indicator goes out.	N/A
78	X-Y PLOT	Depress. <u>NOTE</u> The data in this step is being read out of memory. Consequently, controls may be changed or input disconnected without affecting the recording of X-Y plot data.	Indicator comes on, display disappears, and intensified dot begins a 30-second sweep from left to right across CRT. At conclusion of sweep, indicator goes out and display returns.	a. If indicator does not light, A1 PCB faulty. Refer to paragraph 7-7.1. b. If indicator lights but no sweep appears, A2 PCB faulty. Refer to paragraph 7-7.22.
79	X-Y PLOT	Depress. After approximately 1 second, depress switch again.	a. X-Y PLOT indicator comes on, display disappears, and intensified dot begins a 30-second sweep across CRT. b. Coincident with second time switch is depressed, X-Y PLOT indicator goes out and display returns.	A2 PCB faulty. Refer to paragraph 7-7.22.
80	CHANNEL A ON	Depress.	Channel A dBm indicator and OFFSET dB display comes on.	
81	None	Disconnect RF detector from B and connect to R.	N/A	N/A
82	Channel A INPUT R	Depress.	Trace appears near center of CRT.	N/A

Table 3-5. Operational Checkout and Troubleshooting Using Front Panel Controls and Potentiometers (Continued)

Step	Control	Procedure	Normal Indication	If Indication Abnormal
83	Channel B INPUT R	Depress.	Second trace appears near center of CRT.	N/A
84	Channel A OFFSET	Rotate CW to position Channel A trace 3 divisions up from centerline.	Channel A trace superimposed on next-to-top graticule-line.	N/A
85	Channel B OFFSET	Rotate CCW to position Channel B trace 3 divisions down from centerline.	Channel B trace superimposed on next-to-bottom graticule-line.	N/A
86	X-Y PLOT	Depress.	<p>a. X-Y PLOT indicator comes on when control is depressed.</p> <p>b. After a short delay, intensified dot begins 30-second sweep for Channel A trace (top of CRT). Approximately 1 to 2 seconds after Channel A sweep, dot returns to left side of CRT and begins 30-second sweep for Channel B trace (bottom of CRT). After Channel B sweep, indicator goes out and refresh displays return.</p>	A2 PCB faulty. Refer to paragraph 7-7.22.
87	CHANNEL A ON	Depress.	<p>a. Channel a dBm indicator and OFFSET dB display go out.</p> <p>b. Channel A trace disappears.</p>	N/A

Table 3-5. Operational Checkout and Troubleshooting Using Front Panel Controls and Potentiometers (Continued)

Step	Control	Procedure	Normal Indication	If Indication Abnormal
88	REAL TIME	Depress.	Refresh display disappears and real time display returns.	N/A
89	SWEEP TIME (on 6600(A)), TIME-SECONDS (on 8620)	On sweeper, set controls for a 3- to 5-second sweep.	Horizontal sweep on 560A CRT slows and trace changes to intensified dot sweeping across screen.	N/A
90	X-Y PLOT	Observe CRT and when intensified dot reaches near mid screen, depress X-Y PLOT; listen for clicking sound.	<p>a. X-Y PLOT indicator lights when control depressed.</p> <p>b. When first click is heard, plot begins and intensified dot begins left to right sweep. When second click is heard, plot is finished and indicator goes out.</p> <p>c. Real time sweep returns to CRT.</p>	A2 PCB faulty. Refer to paragraph 7-7.22.
91	CHANNEL A ON	Depress.	Channel A dB indicator and OFFSET dB display lights.	N/A
92	X-Y PLOT	Observe CRT and when intensified dot reaches middle of Channel A sweep (top of CRT), depress X-Y PLOT; listen for clicking sound.	<p>a. X-Y PLOT indicator comes on when control is depressed.</p> <p>b. Intensified dot completes sweeping Channel A trace then returns to the left side of screen and starts sweeping Channel B trace. After Channel B sweep, clicking sound is</p>	A2 PCB faulty. Refer to paragraph 7-7.22.

Table 3-5. Operational Checkout and Troubleshooting Using Front Panel Controls and Potentiometers (Continued)

Step	Control	Procedure	Normal Indication	If Indication Abnormal
92	(Cont'd)		heard and intensified dot begins Channel A sweep. Channel A is swept (plotted) and then Channel B is swept (plotted). After Channel B sweep (plot), a second click is heard and indicator goes out. c. Real time sweep returns.	
93	CHANNEL A ON	Depress.	a. Channel A dB indicator and OFFSET dB display go out. b. Channel A sweep disappears.	N/A
94	SMOOTHING	Depress control several times and observe that indicators switch between OFF, MIN, and MAX.	Indicators switch between OFF, MIN, and MAX.	Refer to Figure 7-16.
95	SWEEP TIME (on 6600(A)), TIME-SECONDS (on 8620)	On sweeper, set controls for a 10 ms sweep.	Horizontal sweep on 560A CRT speeds up, display changes from intensified dot to trace.	N/A
96	None	On 560A, observe UNCAL, REDUCE SWEEP SPEED indicator.	UNCAL indicator flashing.	Refer to Figure 7-17.
97	None	On sweeper, rotate sweep VERNIER control CCW until UNCAL indicator goes out.	UNCAL indicator off.	N/A

Table 3-5. Operational Checkout and Troubleshooting Using Front Panel Controls and Potentiometers (Continued)

Step	Control	Procedure	Normal Indication	If Indication Abnormal
<u>SWR Autotester Checkout</u>				
98	OFFSET	Rotate to position trace on center line of graticule. Record value of OFFSET dB display.	Trace located on center line.	N/A
99	None	Disconnect RF Detector from sweep generator RF OUTPUT connector.	N/A	N/A
100	None	Connect INPUT port of SWR Autotester to sweep generator RF OUTPUT connector.	N/A	N/A
101	None	Connect Channel B RF Detector to TEST PORT of SWR Autotester; output of SWR Autotester may be left disconnected.	Trace appears on display.	N/A
102	OFFSET	Rotate to position trace on center line of graticule. Record value of OFFSET dB display.	Approximately 6.5 dB difference between OFFSET dB value obtained in Step 99 and OFFSET dB value obtained in this step.	SWR Autotester faulty. Refer to paragraph 7-5.1.

3.4.3 CRT Mainframe Horiz Position and Trace Rotate Adjustment Instructions

The HORIZ POSITION and TRACE ROTATE controls are mounted on the front panel. Their adjustment is specified in steps 13 and 15 of Table 3-5. Adjustment instructions are given below.

- a. The HORIZ POSITION potentiometer moves the displayed trace horizontally on the CRT. Clockwise (CW) adjustment moves the trace to the right; counter-clockwise (CCW) adjustment moves the trace to the left.

- b. The TRACE ROTATE potentiometer adjusts the slope of the displayed trace. The adjustment of the potentiometer moves the trace as shown by the arrows labeled A and B below. CW adjustment is shown by arrow A, and CCW adjustment is shown by arrow B.

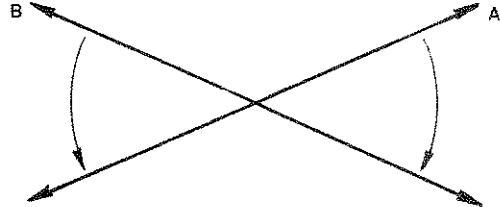

3-5 LOW LEVEL (<45 dBm) TRIM ADJUSTMENTS

The low-level trim potentiometers are internally mounted and are accessible through holes in the right side panel (Figure 3-13). The potentiometers are used to cancel the effects of thermocouple junctions that exist between the RF detector (or SWR Autotester) and the input to the A or B log amplifier. In normal operation for most low-level measurements using standard 560 microwave components (RF detector or SWR Autotester), the adjustment of the CH A or CH B LOW LEVEL TRIM potentiometers is unnecessary; however, for measurements below approximately -45 dBm, adjustment of the applicable channel's LOW LEVEL TRIM potentiometer can provide increased low-level accuracy. Additionally, the LOW LEVEL TRIM potentiometers are used to ensure accurate low-level measurements when the 560-10BX(-1) cable is used. This cable adapts waveguide or other non-560 type RF detectors (or SWR Autotesters) for use with the 560A.

The test setup for the low-level trim adjustments is shown in Figure 3-14; a procedure for adjusting the CH A and CH B potentiometers is given in Table 3-6. The procedure in Table 3-6 provides the CRT deflection circuits with a calibrated voltage

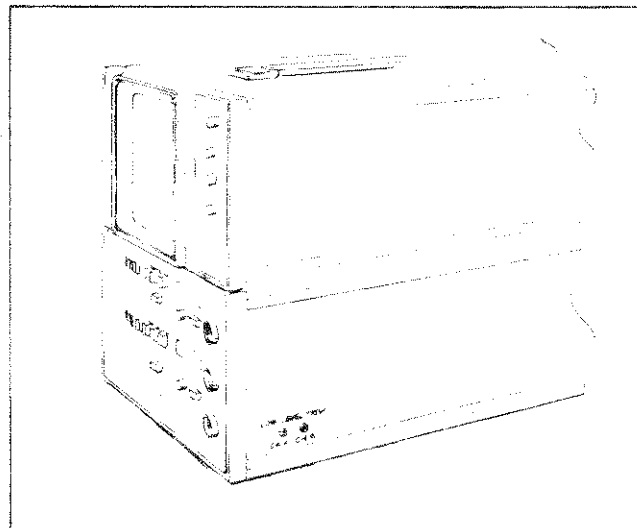

Figure 3-13. Location of Low-Level Trim Potentiometers

from the OFFSET potentiometer that represents the approximate noise floor of the A, B log amplifier. Since no input signal is provided to the A, B log amplifier, the waveform present on the CRT represents the noise level of the first amplifier stage. The CH A or CH B potentiometer is adjusted until the noise level of this amplifier stage is near the noise floor and only random negative clipping occurs. Allow the 560A to warm up for at least 30 minutes before performing the procedure in Table 3-6.

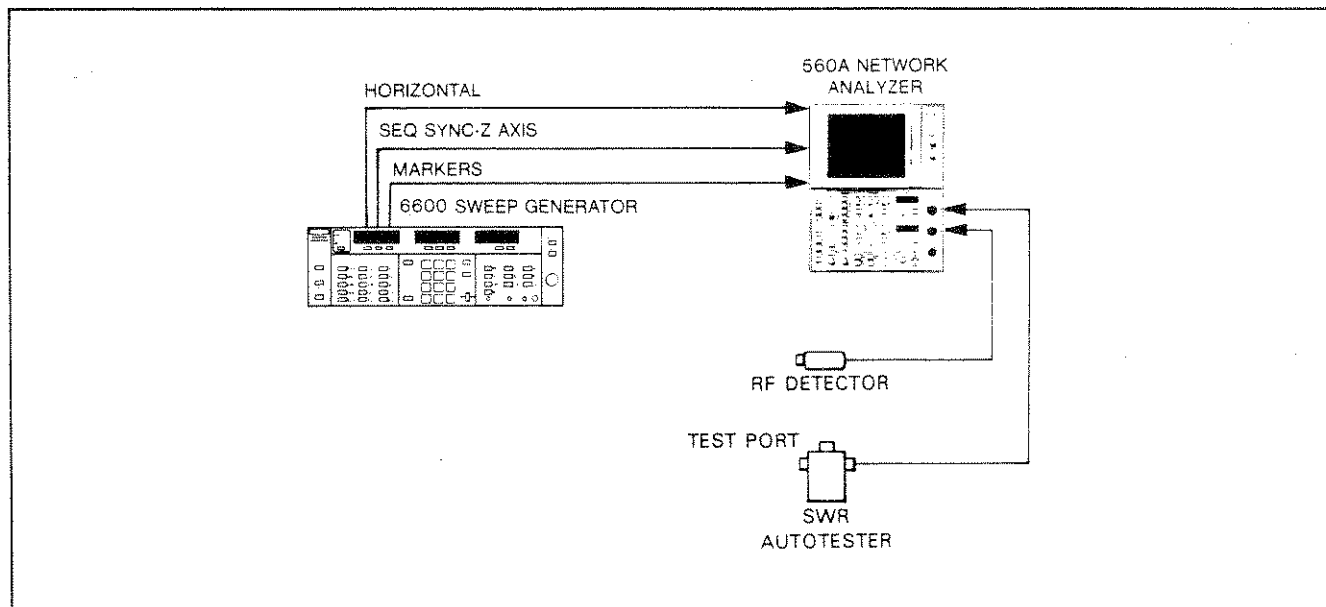

Figure 3-14. Equipment Setup for Low-Level Trim Adjustment

Table 3-6. Channel A and Channel B Low Level Trim Procedure

1. Set up equipment and perform initial switch positioning:

Sweep Generator

MARKERS: VIDEO
 MARKER AMPLITUDE: Fully CCW
 TRIGGER: AUTO
 SWEEP TIME: 100 ms
 FREQUENCY RANGE: F1 TO F2
 RETRACE RF: OFF
 F1: Lower frequency of interest
 F2: Higher frequency of interest
 LEVELING: INTERNAL
 POWER: ON
 RF: OFF
 LEVEL: Maximum leveled power
 (UNLEVELED light will be on; disregard it.)
 SLOPE: N/A

Network Analyzer

CHANNEL A: ON

INPUT: A
 MEMORY: OFF
 dB PER DIVISION: 1
 REFERENCE dB/dBm: Depressed
 (dBm indicator lit)
 OFFSET ZERO: Not depressed
 CHANNEL B: OFF
 INPUT: B
 MEMORY: OFF
 dB PER DIVISION: 1
 REFERENCE dB/dBm: Depressed
 OFFSET ZERO: Not depressed
 THRESHOLD: OFF (fully CCW)
 TILT: Center of range
 DISPLAY MODE: REFRESH
 SMOOTHING: OFF
 POWER: ON
 LOW LEVEL CAL (rear panel): NORM

Step	Procedure	Result
2.	Depress and hold Channel A REF POS LOCATE pushbutton switch. Adjust SET potentiometer to position reference line on center graticule line.	
3.	Release REF POS LOCATE.	N/A
4.	Depress SMOOTHING pushbutton switch until MAX indicator lights.	MAX indicator lit.
5.	Adjust Channel A OFFSET control for -58.0 on OFFSET dB display.	OFFSET dB display indicates -58.0.

Table 3-6. Channel A and Channel B Low Level Trim Procedure (Continued)

Step	Procedure	Results
6.	<p>A trace similar to one of the three examples shown should appear on the display. If trace is not present, proceed to Step 6A. If trace is present, proceed to Step 7.</p>	<p style="text-align: center;">EXAMPLE 1</p>  <p style="text-align: center;">Noise trace with no clipping, but located too far above reference line.</p> <p style="text-align: center;">EXAMPLE 2</p>  <p style="text-align: center;">Noise trace with no clipping, located on reference line.</p> <p style="text-align: center;">EXAMPLE 3</p>  <p style="text-align: center;">Noise trace with clipping.</p>
6A.	<p>Increase dB PER DIVISION switch-bank until trace appears on screen. Adjust CH A potentiometer clockwise to position trace on centerline. Return dB PER DIVISION switch-bank setting to 1. Proceed to Step 7.</p>	<p style="text-align: center;">N/A</p>

Table 3-6. Channel A and Channel B Low Level Trim Procedure (Continued)

Step	Procedure	Results
7.	If trace is being clipped (Example 3 in Step 6), adjust CH A potentiometer counterclockwise until clipping just ceases. If trace is not being clipped (Examples 1 and 2 in Step 6), adjust CH A potentiometer clockwise until clipping just starts; back potentiometer off until clipping just ceases.	Trace containing noise with no clipping appears on or near -58 dB reference line (Example 2 in Step 6).
8.	Depress CHANNEL B ON pushbutton switch.	Channel B dBm indicator and OFFSET dB display light.
9.	Depress CHANNEL A ON pushbutton switch.	Channel A dBm indicator and OFFSET dB display go out.
10.	Repeat steps 2, 3, and 5 through 7 for Channel B.	

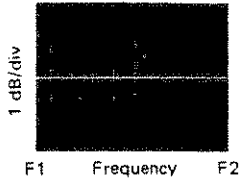
3-6 560-10BX(-1) CABLE

The 560-10BX(-1) cable permits the 560A to be used with detectors other than the 560-7 and 560-71 series and with SWR Autotesters other than the 560-97, -98, and -6 series; specifically, the cable allows the 560A to be used with all types of waveguide detectors and with other SWR Autotesters, e.g. the Series -97, -98, and -63. Before making measurements using this cable, it is necessary to adjust the applicable CH A or CH B LOW LEVEL TRIM side panel potentiometer. To perform this adjustment, connect the 560-10BX(-1) cable between the 560A A or B connector and the RF detector; leave the RF detector unconnected from the source and perform the low-level trim procedure in Table 3-6.

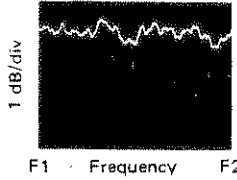
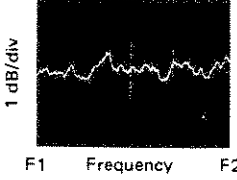
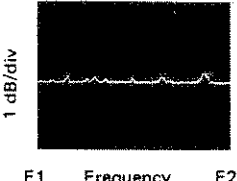
NOTE

When making measurements using the 560-10BX(-1) cable, there are two factors that should be considered. Because the 560 microwave components and 560A network analyzer are interdependent, the accuracy of absolute power (dBm) and low-level power (<-40 dBm) measurements made with the 560-10BX(-1) cable cannot be specified. Consequently, all measurements should be made with the 560A REFERENCE dB/dBm switch in the dB position, and transmission or return loss measurements below approximately -40 dBm should not be attempted.

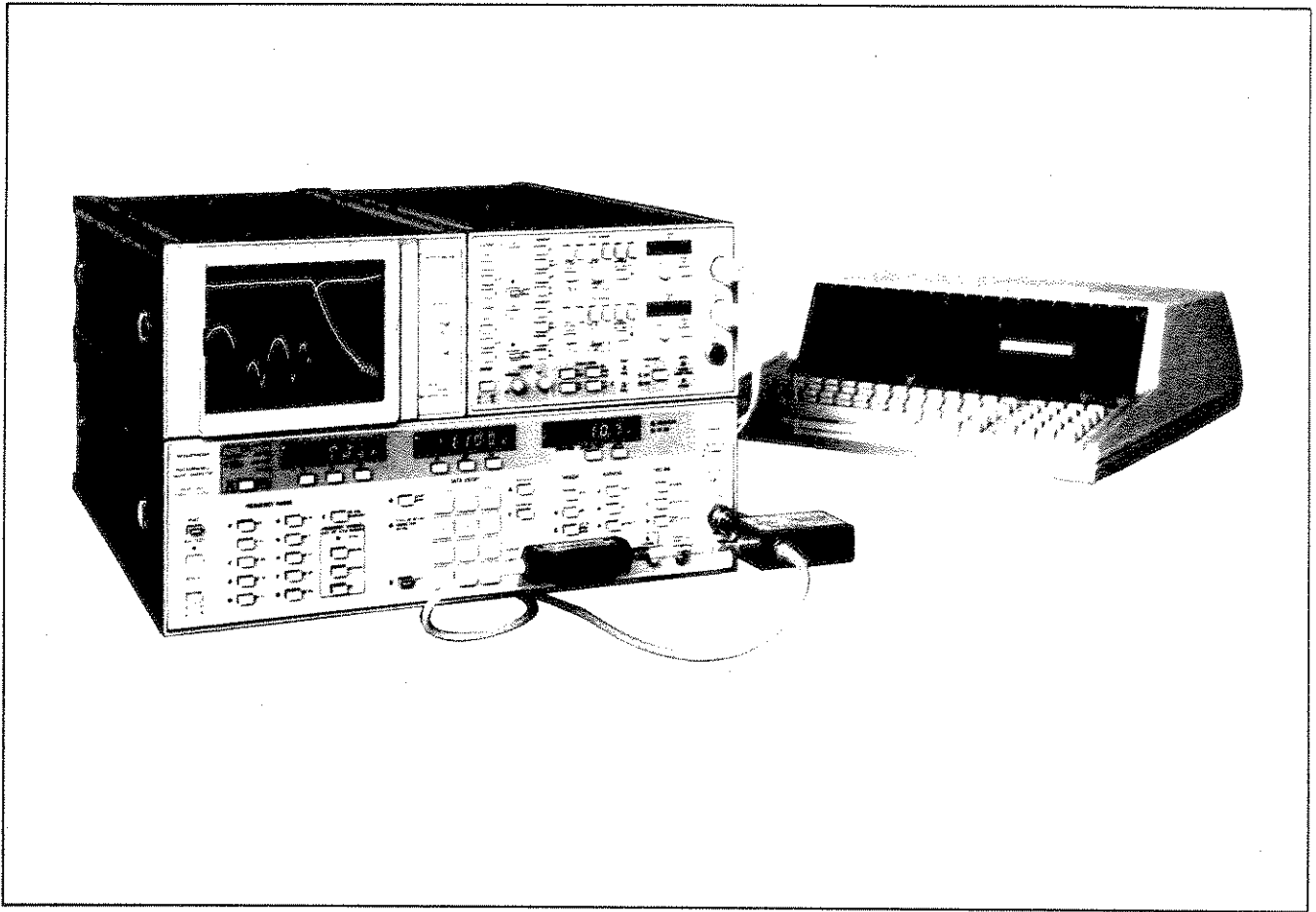

Figure 3-15. Typical GPIB Equipment Setup

3-7 GPIB OPERATION (OPTION 3)

A typical GPIB equipment setup consists of a WILTRON Model 560A/Option 3 Scalar Network Analyzer, a Model 6647(A)/Option 3 Programmable Sweep Generator, and a Model 85 Controller (Figure 3-15). In a measurement setup of this type, the 560A is capable of providing automated microwave transmission and return loss measurements. GPIB operation for the 560A is described in the following paragraphs.

3-7.1 General Information and Description of Model 560A GPIB Command Codes

The Model 560A is used on the interface bus as both a listener and a talker. When addressed to listen, the 560A can be com-

manded to collect measurement data and to make that data available to the bus. When addressed to talk, the data which has been collected is sent over the bus to all listeners. Also, in a semi-automatic bus operation, the 560A can be programmed to furnish data to an analog, non-GPIB X-Y plotter.

Interconnection to the GPIB is shown in Figure 3-16. Except for the output connection labeled DISPLAY (used during AD, BD modes only -- see subparagraph a below), the GPIB Interface Circuit Board is connected to the outputs of the channel-amplifiers and the subtract circuit. With connection made at these points, except for POWER, none of the Model 560A front panel controls (MEMORY, dB PER DIVISION, DISPLAY MODE, etc.) have any effect on bus opera-

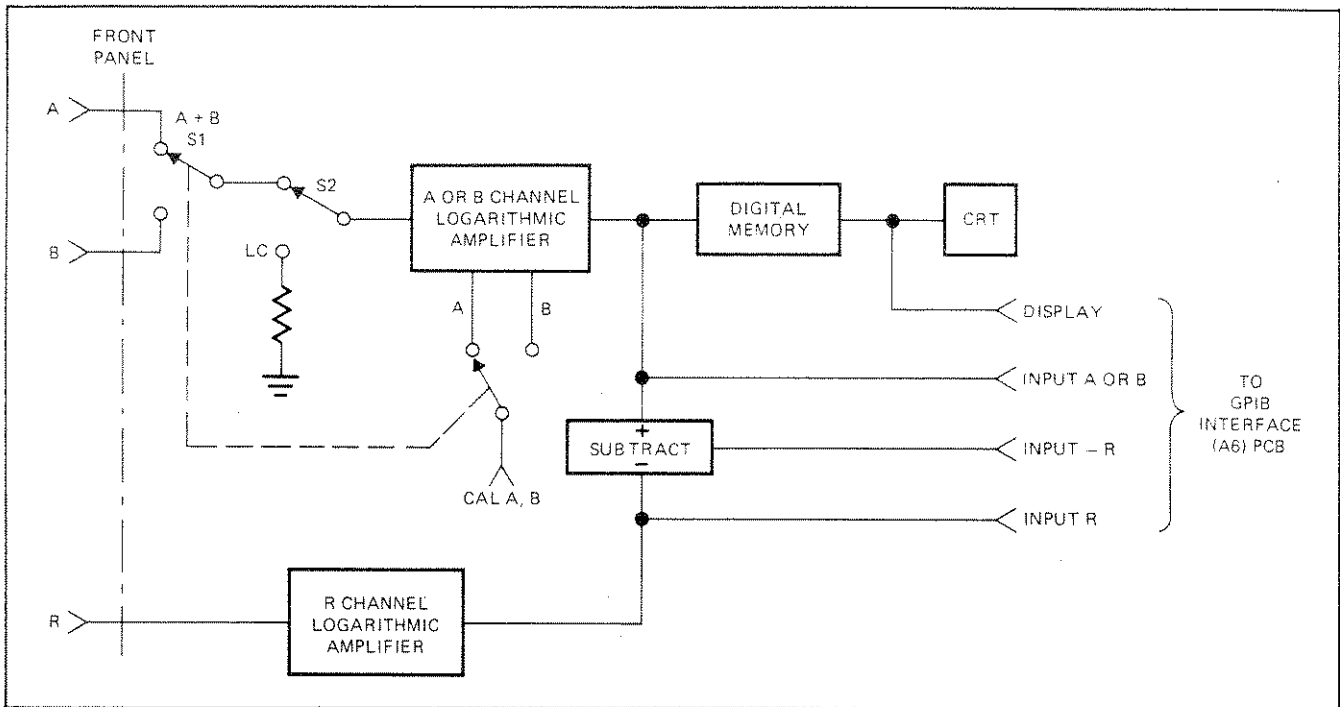

Figure 3-16. Simplified Block Diagram Showing GPIB Interconnection

tion. Measurement data is detected by the applicable microwave input device (RF detector of SWR Autotester), amplified, and applied directly to analog-to-digital converters located on the 560A GPIB Interface Circuit Board.

Control over the Model 560A bus operations is provided through the use of twenty 2-character command codes. These command codes are categorized into four functional groups, plus two miscellaneous commands. The four command groups are data, calibrate, smoothing, and mode. The two miscellaneous commands are XY (initiate X-Y plot) and RL (return to local). Command codes are described below.

- a. Data Commands. Data commands are used to direct the 560A to collect and condition (digitize) data for transmission over the bus. Data commands consist of input commands, input minus reference commands, display commands, and a special noise level (NL) command that is used to obtain a readout of the selected amplifier's internal noise level

(noise floor). Descriptions of these commands follow:

1. Input commands AI, BI, and RI provide for collection of input data from A Channel, B Channel, and R Channel, respectively. These codes command the 560A to (1) collect analog data from the respective A, B, or R Channel log amplifier, (2) convert the analog data collected into a 7-bit ASCII format, and (3) hold the ASCII binary data until addressed to talk. To see how this multilevel task is accomplished, refer to Figure 3-16 while reading the following description.

When either an AI or BI command is received, S1 connects the appropriate front panel channel connector (A, B) to the input of the A or B Channel log amplifier; at the same time, the input line INPUT A or B is connected to the GPIB Interface Board A/D Converter input. When RI is received, the input line INPUT R is connected to the GPIB Interface

Board A/D Converter input (amplifier input is always connected to front panel connector). The analog data from the applicable log amplifier is then routed to the GPIB Interface Circuit Board, where it is converted to ASCII data and held for later transmission over the bus. Transmission of the data does not occur until the 560A is addressed to talk.

2. The input-minus-reference commands, AR and BR, provide for collection of A-R and B-R data, respectively. Circuit operations are similar to those described for the input commands. The main difference between operation in these modes and operation in the input modes is the point from which the circuit output is taken. As shown in Figure 3-16, the circuit output is taken from the Subtract circuit; this circuit contains the difference signal when the selected A or B Channel output signal is subtracted by the R Channel output signal.
3. Display commands AD and BD provide for the collection of CRT vertical deflection data from Channel A and Channel B, respectively. As the CRT horizontal frequency data sweeps across the screen, the point at which an AD or BD command is received determines the frequency at which vertical data is supplied to the bus. This vertical data is supplied to the bus in a 160-unit format, with 80 units displayed on-screen and 80 units off-screen in an area known as overrange deflection. An oscillograph relating the CRT screen to this 160-unit digital readout format, plus a narrative describing how to interpret this format, are presented in Figure 3-17. For the display commands to be used, however, the following 560A front panel controls must be positioned as indicated below:

AD command - CHANNEL A ON,
depressed

CHANNEL B ON,
not depressed
REAL TIME,
depressed.

BD command - CHANNEL A ON,
not depressed

CHANNEL B ON,
depressed
REAL TIME,
depressed

4. Noise level command NL provides for measurement, in dBm, of the A, B Channel log amplifier's internal noise level (noise floor). During measurements, this command can be used to determine the 560A's actual sensitivity. Although sensitivity is specified at -50 dBm, the 560A is often usable to -55 dBm or less.

- b. Calibrate Commands. Calibrate commands are used to correct for thermal drift within the A, B Channel log amplifier. Under local (non-GPIB) control, thermal drift is compensated for during sweep generator retrace. Under GPIB control, however, thermal compensation has to be programmed. Programming is accomplished through the use of calibrate commands. Calibrate commands consist of local calibrate (LC), external calibrate (EC), and channel select (CA, CB) commands. To provide optimum amplifier accuracy, calibrate command LC or EC should be programmed for bus transmission each time the 560A is turned on and again prior to each series of measurements. Before sending a calibrate command, however, the desired channel (A or B) must be selected. Channel selection is accomplished either by sending a channel select command such as CA or CB, or by sending a data command such as AI, BI, RI, AR, BR, AD or BD. The calibrate commands are described below.

1. Local calibrate command LC provides

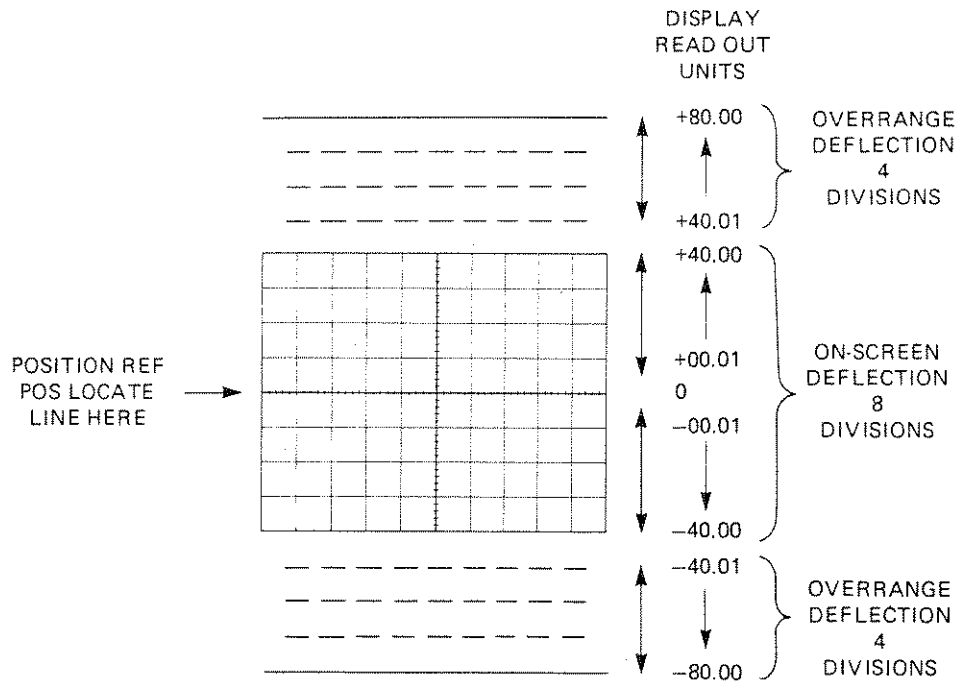

The CRT display range includes screen and eight divisions of overrange deflection. As shown above, this display range is organized into a 160-unit format. The 80.00 units preceded by the positive (+) sign are allocated to the top half of the display range, and the 80.00 units preceded with the minus (-) sign are allocated to the bottom half of the display range. Since these units are fixed with reference to the CRT centerline graticule, the 560A vertical deflection system should also be referenced to the centerline. This can be accomplished by positioning the REF POS LOCATE reference line on the centering graticule (see oscillograph above).

With the 560A vertical display data referenced to the centerline, the digitized readout that results from a display command can be converted into the input signal's absolute value, in dBm. To effect this conversion, however, the values of the dB PER DIVISION switch bank and the OFFSET dB display must be known. Also, the REFERENCE dB/dBm switch must be in the dBm position (pushbutton switch depressed.) The formula for accomplishing data conversion is shown below.

$$\left(\frac{\text{Readout Digit}}{10} \times \text{dB/DIV} \right) + \text{OFFSET} = \text{dBm}$$

Where Readout Digit refers to the four-digit computer readout, including algebraic sign and decimal point.

dB/DIV refers to the value of the dB PER DIVISION switch bank.

OFFSET refers to the value of the OFFSET dB LED display.

Example: Assume computer Readout Digit equals +20.10; dB PER DIVISION switch bank equals .5 (.5 pushbutton switch depressed), and OFFSET dB display equals +10.2.

$$\left(\frac{+20.10}{10} \times 0.5 \right) + +10.2 = +11.2 \text{ dBm}$$

Figure 3-17. Digitized Display Resulting from Display Command (AD or BD), and Example Showing Conversion of Readout Digits to True Measurement Value

thermal compensation for the A, B Channel log amplifier with no signal present and with the amplifier input grounded. To see the circuit operation, refer to Figure 3-16. When the LC command is received, switch S2 momentarily grounds the A or B Channel log amplifier input; the CAL A, B signal causes thermal compensation to be affected.

2. External calibrate command EC provides thermal compensation for the A, B Channel log amplifier when the amplifier input is connected to its microwave input device (RF detector or SWR Autotester). This command provides better thermal compensation than LC does; however, sweep generator RF must be off (<-60 dBm) for this command to be effective. Circuit operation for EC is the same as described for LC, except that switch S2 is not affected and remains connected, as shown in Figure 3-16.
 3. Channel select commands CA and CB provide channel-switching only. In the absence of a data command, these two commands select the channel to which the calibrate signal will be applied. As shown in Figure 3-16, channel input switch S1 is "ganged" with the CAL A, B switch. When a CA or CB command is received, it causes these two switches to switch to their A or B positions, respectively. The CAL A, B switch is used to apply the calibrate signal to the appropriate amplifier; S1 is used to connect the appropriate channel connector to the amplifier unit.
- c. Smoothing Commands. Smoothing commands provide for A, B Channel log amplifier smoothing. The three smoothing commands S \emptyset , S1, and S2 correspond to the OFF, MIN, and MAX positions of the front panel SMOOTHING switch. Amplifier smoothing operations caused by these commands are identical to those caused by the SMOOTHING switch. These operations are described

in paragraph 3-3.6.

Although the smoothing process is the same for both local and bus operation, there is an inherent log amplifier characteristic that affects smoothing during bus operation. This characteristic determines the amount of time required for the log amplifier to process input signals with rapidly-changing power levels, such as those seen when measuring the transmission or return loss of an electronic filter. (A filter can cause a power change of 50 or 60 dB when the frequency sweep crosses the bandpass/reject crossover point.) The worst-case (power change from +16 to -55 dBm) time required for log amplification is 12 ms for normal smoothing (S \emptyset), 40 ms for minimum smoothing (S1), and 200 ms for maximum smoothing (S2).

For local (non-GPIB) operation, these times are not significant. For GPIB operation, however, these times are very significant because overall GPIB operational speed is affected. Remember, because of the asynchronous three-wire handshake process, the speed of GPIB operations is determined by the speed with which the slowest instrument can process data. Consequently, the delay in the 560A between the time a measurement starts and the time data is available for bus transmission affects overall GPIB speed.

Three methods of reducing this delay time have been devised. The first method, using hardware to determine which level of smoothing has been selected, is described later in this paragraph. The other two methods, interrupt mode and fast mode, are described in subparagraph d.

The method of using hardware to determine which level of smoothing has been selected is represented in the flowchart in Figure 3-18. This flowcharted routine is initiated by receipt of one of the data commands (AI, BI, RI, AR,

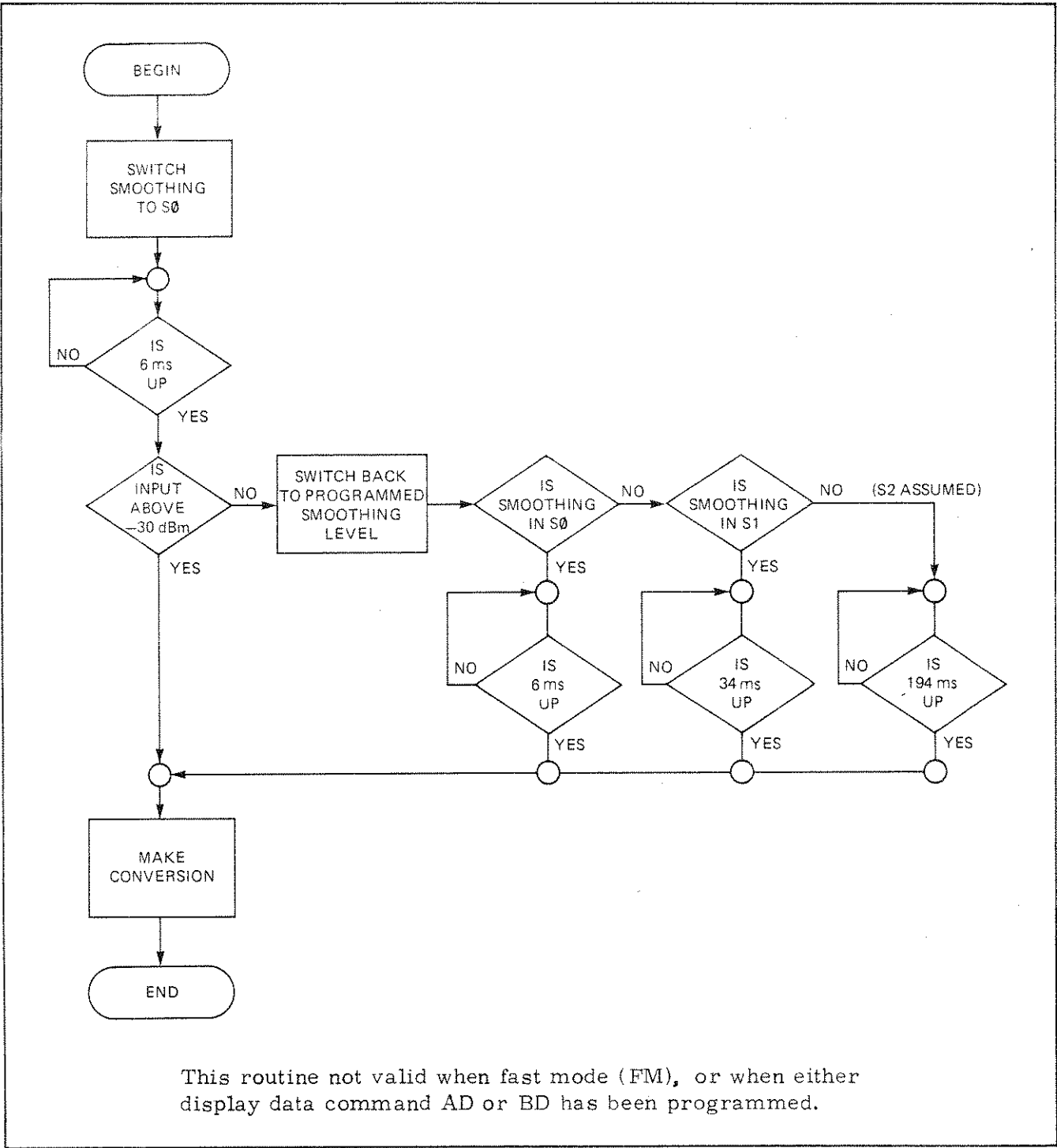

Figure 3-18. Flowchart Showing Smoothing Command Operation

BR, AD, BD, or NL). The routine starts off by switching smoothing to SØ and waiting 6 ms for the input data to settle. After this 6 ms delay, the routine determines whether the input signal is above or below -30 dBm. If above -30 dBm (i. e. , +16 to -30), no further settling time is required and the input analog signal is converted to ASCII data bytes and made available for bus transmission. If, however, the input signal is determined to be below -30 dBm, more settling time is required before data conversion. The amount of additional settling time required depends on the level of smoothing programmed. If SØ is programmed, an additional 6 ms is required. If S1 is programmed, an additional 34 ms is required. If S2 is programmed, an additional 194 ms is required. The result of this overall routine is: for input power levels above -30 dBm, overall settling time is 6 ms regardless of which smoothing level is programmed; for input power levels below -30 dBm, overall settling time is 12 ms for SØ, 40 ms for S1, and 200 ms for S2. The GPIB operator can see the results of this routine's logical decision processes by observing the front panel SMOOTHING OFF, MIN, and MAX indicator LED's. These LED's change as the routine runs its course.

d. Mode Commands. Mode commands provide alternate methods of data conversion and data handling. These commands consist of hold mode (HM), interrupt mode (IM), and fast mode (FM). The HM, IM, and FM modes provide, respectively, normal data conversion with its up to 200 ms amplifier settling time requirement, normal conversion but with more efficient data handling using the SRQ management bus control line, and fast (immediate) data conversion. These three modes are described below.

1. Hold mode command HM provides for data conversion in the normal (up to 200 ms delay) mode. Upon receipt of

a data command (AI, BI, RI, AR, BR, AD, or BD), the 560A initiates the flowcharted process shown in Figure 3-18. If the 560A is addressed to talk before the flowcharted process has run its course, GPIB handshake is inhibited until data conversion is complete. This is the easiest and least complex mode for which to program. Also, this is the default mode of operation. Each time power is applied, the 560A comes on line in this mode.

2. Interrupt mode command IM also uses the flowcharted process of Figure 3-18 for data conversion. However, in this mode, instead of delaying bus operation by holding up the handshake when addressed to talk, the Service Request (SRQ) control line is used. This line is set TRUE (low) to indicate an instrument needs service. When the controller senses that SRQ is TRUE, it sets ATN TRUE and sends a serial poll enable message to all instruments. When the 560A receives this message, it responds when next addressed to talk with an appropriately-coded Status Byte (STB). The status byte and request service bit are shown in Figure 3-19.
3. Fast mode command FM provides for data conversion without waiting for

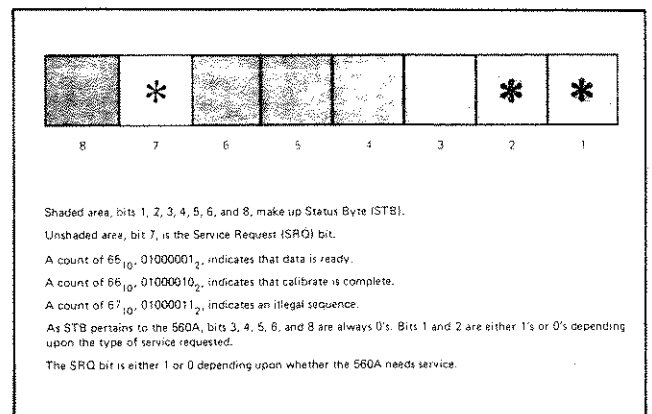

Figure 3-19. Request Service Bit and Status Byte

the normal, up to 200 ms, log amplifier delay (settling time). In this mode, the 560A completes data conversion immediately upon receipt of a data command. This mode provides for very rapid data transactions and it can be used to advantage in "averaging" algorithms. This mode should be used with care, however. Since it does not allow for amplifier settling, measurement data obtained using the fast mode could contain errors if used incorrectly.

e. Miscellaneous Commands. Miscellaneous commands XY and RL are used to control auxiliary GPIB functions. These two commands are described below.

1. The XY command is used to initiate an X-Y plot when a non-GPIB X-Y plotter is connected to rear panel connectors. The operation that this command controls is semi-automatic, in that manipulation of front panel controls is necessary to obtain a proper CRT display. When this command is sent over the bus, it serves the same function as physically depressing the front panel X-Y PLOT pushbutton switch. Operation of the X-Y pushbutton switch is described in paragraph 3-3.5. (An X-Y plot can also be initiated from the front panel while under GPIB control.)
2. The RL command is used to return the 560A to local (front panel) control.

3-7.2 Summary of GPIB Command Codes

To provide quick reference to GPIB command codes, a summary description of each code is provided in Table 3-7. Also, each code contains reference to the paragraph in text where the command is fully described.

3-7.3 Data Output Format

When addressed to talk, the 560A transmits ASCII coded data to the bus in the following format: +DD.DD CR(LF). In this format, the letter "D" stands for digit; the letters CR(LF) are abbreviations for carriage

return and line feed, respectively. The LF abbreviation is set off in parentheses because the ASCII character for line feed may not be transmitted; this character can be inhibited by the rear panel CR-CR/LF switch. When this switch is in the CR position, the line feed character is inhibited. Conversely, when the switch is in the CR/LF position, the line feed character is sent over the bus. This format produces a controller readout similar to the following example: +18.12. An explanation of the +DD.DD CR(LF) format is shown below.

- Sign (+/-) character
- Most significant measurement digit
- Next most significant measurement digit
- Decimal point
- Next least significant measurement digit
- Least significant measurement digit
- Least significant measurement digit
- Carriage return character (CR)
- Line feed character (LF)

3-7.4 Sample Program in HPL Computer Language for HP 9825A Programmable Calculator

A sample program in HPL that exercises most of the 560A GPIB functions is presented in Figure 3-20. This program is intended for use with a GPIB system that uses an HP 9825A Programmable Calculator as system controller.

3-7.5 Sample Program in BASIC Computer Language for Commodore PET 2001 Controller

A sample program in BASIC that exercises most of the 560A GPIB functions is presented in Figure 3-21. This program is intended for use with a GPIB system that uses a Commodore PET 2001 as system controller.

3-7.6 Sample Program in BASIC Computer Language for HP 85 Controller

A sample program in BASIC that exercises most of the 560A GPIB functions is presented in Figure 3-22. This program is intended for use with a GPIB system that uses an HP 85 as system controller.

Table 3-7. Summary of GPIB Command Codes

Command Code	Name	Function
AI	A Channel Input	Connects A Channel to bus; returns data in dBm. See paragraph 3-7.1, a, 1 for description.
BI	B Channel Input	Connects B Channel to bus; returns data in dBm. See paragraph 3-7.1, a, 1.
RI	R Channel Input	Connects R Channel to bus; returns data in dBm. See paragraph 3-7.1, a, 1.
AR	A Channel minus R Channel	Connects A-R to bus; return data proportional to the dB difference between A Channel and R Channel. See paragraph 3-7.1, a, 2.
BR	B Channel minus R Channel	Connects B-R to bus; returns data proportional to the dB difference between B Channel and R Channel. See paragraph 3-7.1, a, 2.
AD	A Channel Display	Connects A Channel CRT display to bus. Returns data in a ± 80.00 -unit format. See paragraph 3-7.1, a, 3.
BD	B Channel Display	Connects B Channel CRT display to bus. Returns data in a ± 80.00 -unit format. See paragraph 3-7.1, a, 3.
NL	Noise Level	Returns data, in dBm, of A, B Channel log amplifier noise floor. See paragraph 3-7.1, a, 4.
LC	Local Calibrate	Connects input of A, B Channel log amplifier to ground and compensates thermal drift. Desired channel must first be selected using either AI, BI, BR, CA, or CB. See paragraph 3-7.1, b, 1.
EC	External Calibrate	Compensates A, B Channel log amplifier drift with microwave input components connected to amplifier input. Sweep generator RF must be off (< -60 dBm). Desired channel must first be selected (see above). See paragraph 3-7.1, b, 2.

Table 3-7. Summary of GPIB Command Codes (Continued)

Command Code	Name	Function
CA	A Channel Select	Connects A Channel to bus. See paragraph 3-7.1, b, 3.
CB	B Channel Select	Connects B Channel to bus. See paragraph 3-7.1, b, 3.
S0	Smoothing Off	Provides for minimal smoothing. See paragraph 3-7.1, c.
S1	Smoothing Minimum	Provides for first level (MIN) smoothing when input signal is below -30 dBm. See paragraph 3-7.1, c.
S2	Smoothing Maximum	Provides for second level (MAX) smoothing when input signal is below -40 dBm. See paragraph 3-7.1, c.
HM	Hold Mode	Provides for amplifier settling times of up to 200 ms before allowing data conversion and GPIB handshake. See paragraph 3-7.1, d, 1.
IM	Interrupt Mode	Provides for more efficient data handling using GPIB SRQ function. Data conversion is handled normally, but handshake is completed immediately upon receipt of data command. See paragraph 3-7.1, d, 2.
FM	Fast Mode	Enables immediate data conversion and GPIB handshake. Extremely fast method for data transaction; however, because amplifier settling time is not provided, measurement errors may be introduced. See paragraph 3-7.1, d, 3.
XY	Plot	Initiates X-Y plot when non-GPIB plotter is connected to rear panel jacks. See paragraph 3-7.1, e, 1.
RL	Return to Local	Returns 560A to local (front panel) control. See paragraph 3-7.1, e, 2.

```

0: ent "ENTER 560 ADDRESS", A; 700+A} A
1: dev "560", A; dim A$[32]
2: wrt "560", "CALC"; prt "CA LC"
3: wrt "560", "CBLC"; prt "CB LC"
4: wrt "560", "CANL"; red "560", A$; prt "CA NL= ", A$
5: wrt "560", "CBNL"; red "560", A$; prt "CB NL= ", A$
6: wrt "560", "AI"; red "560", A$; prt "A INPUT= ", A$
7: wrt "560", "BI"; red "560", A$; prt "B INPUT= ", A$
8: wrt "560", "RI"; red "560", A$; prt "R INPUT= ", A$
9: wrt "560", "AR"; red "560", A$; prt "A-R= ", A$
10: wrt "560", "BR"; red "560", A$; prt "B-R= ", A$
11: wrt "560", "AD"; red "560", A$; prt "A DISP= ", A$
12: wrt "560", "BD"; red "560", A$; prt "B DISP= ", A$

```

Figure 3-20. Sample Program in HPL for HP 9825A Controller Exercising 560A GPIB Functions

```

200 OPEN6, 6
210 PRINT"CA LC"
220 PRINT#6, "CALC"
230 PRINT"CB LC"
240 PRINT#6, "CBLC"
250 PRINT#6, "CANL"
260 INPUT#6, B$
270 PRINT"CA NL = ", B$
280 PRINT#6, "CBNL"
290 INPUT#6, B$
300 PRINT"CB NL = ", B$
310 PRINT#6, "AI"
320 INPUT#6, B$
330 PRINT"A INPUT = ", B$
340 PRINT#6, "BI"
350 INPUT#6, B$
360 PRINT"B INPUT = ", B$
370 PRINT#6, "RI"
380 INPUT#6, B$
390 PRINT"R INPUT = ", B$
400 PRINT#6, "AR"
410 INPUT#6, B$
420 PRINT"A-R = ", B$
430 PRINT#6, "BR"
440 INPUT#6, B$
450 PRINT"B-R = ", B$
460 PRINT#6, "AD"
470 INPUT#6, B$
480 PRINT"A DISP =", B$
490 PRINT#6, "BD"
500 INPUT#6, B$
510 PRINT"B DISP = ", B$
520 PRINT#6, "S1": FOR J=1TO200: NEXTJ
530 PRINT#6, "S2": FORJ=1TO200: NEXTJ
540 PRINT#6, "S0": FORJ=1TO200: NEXTJ: GOT0520

```

Figure 3-21. Sample Program in BASIC for Commodore PET 2001 Controller
Exercising 560A GPIB Functions

```

10 : 560TST
20 PRINT USING 30
30 IMAGE 5/,"WILTRON MODEL 560
  SCALAR NETWORKANALYZER GPIB
  FUNCTION EXERCISER",5/
40 OUTPUT 706 ;"CALC"
50 PRINT USING 60
60 IMAGE 2/,"CHANNEL A CAL COMP
  LETE",2/
70 OUTPUT 706 ;"CBLC"
80 PRINT USING 90
90 IMAGE "CHANNEL B CAL COMPLET
  E",2/
100 OUTPUT 706 ;"S2CANL"
110 ENTER 706 ; N1
120 PRINT USING 130 ; N1
130 IMAGE "CH. A NOISE LEVEL= ",
  S2D.D," dBM",2/
140 OUTPUT 706 ;"S2CBNL"
150 ENTER 706 ; N2
160 PRINT USING 170 ; N2
170 IMAGE "CH. B NOISE LEVEL= ",
  S2D.D," dBM",2/
180 OUTPUT 706 ;"S0"
190 OUTPUT 706 ;"HMAI"
200 ENTER 706 ; A
210 OUTPUT 706 ;"HMBI"
220 ENTER 706 ; B
230 OUTPUT 706 ;"HMRI"
240 ENTER 706 ; R
250 PRINT USING 260
260 IMAGE "A INPUT",5X,"B INPUT"
  ,5X,"R INPUT",/,2X,"dBm",9X,
  "dBm",9X,"dBm",/
270 PRINT USING 280 ; A,B,R
280 IMAGE X,S2D.D,7X,S2D.D,7X,S2
  D.D,2/
290 OUTPUT 706 ;"HMAR"
300 ENTER 706 ; A1
310 OUTPUT 706 ;"HMBR"
320 ENTER 706 ; B1
330 PRINT USING 340
340 IMAGE 9X,"A-R",.6X,"B-R",/,/,
  10X,"dB",8X,"dB",/
350 PRINT USING 360 ; A1,B1
360 IMAGE 8X,S2D.D,5X,S2D.D,2/
370 CLEAR
380 DISP USING 390
390 IMAGE 2/,"PLACE 560 IN REAL
  TIME MODE",2/,"PRESS CONTINU
  E WHEN READY"
400 BEEP 100,60
410 PAUSE
420 CLEAR
430 OUTPUT 706 ;"CAAD"
440 ENTER 706 ; A2
450 OUTPUT 706 ;"CBBD"
460 ENTER 706 ; B2
470 PRINT USING 480
480 IMAGE 9X,"A DISP",5X,"B DISP
  ",/
490 PRINT USING 500 ; A2,B2
500 IMAGE 9X,S2Z.2D,5X,S2Z.2D,4/
510 OUTPUT 706 ;"RL"
520 PRINT USING 530
530 IMAGE "560 GPIB EXERCISE COM
  PLETE",2/,"PLACE 560 IN REFR
  ESH MODE",5/
540 END

```

Figure 3-22. Sample Program in BASIC for HP 85 Controller Exercising 560A GPIB Functions

3-8. ALTERNATING-SWEEP OPERATION

Alternating-sweep capability allows the 560A to process and then display two swept-frequency ranges with only one RF detector connected to the Channel A input. A sweep generator with alternating-sweep capability, such as the WILTRON

6600(A) Series Programmable Sweep Generator, must be connected to the rear panel AUX I/O connector for the 560A to display simultaneously one swept-frequency range on Channel A and the other swept-frequency range on Channel B. In the alternating-sweep mode, the front panel Channel A and Channel B display controls independently adjust each display trace.

SECTION IV

PERFORMANCE VERIFICATION

4-1 INTRODUCTION

This section provides performance verification philosophy and procedures for the Model 560A Scalar Network Analyzer. Also included is a listing of recommended test equipment.

4-2 RECOMMENDED TEST EQUIPMENT

Performance verification for the 560A can be accomplished using a minimum of test equipment. Table 4-1 provides a listing. If recommended test equipment items are not available, however, equipment with equivalent characteristics may be substituted.

4-3 PERFORMANCE VERIFICATION

The philosophy pertaining to 560A performance verification and the detailed instructions for accomplishing this verification are provided in the following paragraphs.

4-3.1 Performance Verification Philosophy

The 560A performance verification tests verify that the 560A Front Panel (A1), Digital (A2), Power Supply (A4), Interface Control (A8), and optional GPIB Interface (A6) PCB circuits are performing properly, and that the Log Amplifier (A3) PCB circuits are within specified limits for absolute power measurements. These performance tests are verified from the front panel; no internal circuits or controls other than the A3 PCB TEST-NORMAL switch are disturbed. Each performance test contains instructions that, in most cases, direct the reader to Section V for the applicable adjustment procedure, should the test fail. In cases where no adjustments are applicable, the reader is told which PCB is faulty. If all of the tests in paragraph 4-3.2 are with-

in their specified tolerances, the 560A requires no calibration and none should be attempted.

4-3.2 Performance Verification Procedure

The procedure for verifying 560A performance is given below. This entire procedure is intended to be accomplished from start to finish; no break-in points are provided. The performance verification tests require the use of a sweep generator to provide the proper operational signals, and markers.

The radio frequency at which performance verification testing is conducted is 50 MHz. In the front panel and digital PCB tests, this frequency is used for convenience. In the log amplifier and optional GPIB interface PCB tests, this frequency is used for two reasons: the 8481A power sensor is calibrated at 50 MHz, and the 355D Step Attenuator is more accurate at this frequency. (50 MHz is low enough in frequency that the 355D specifications for dc may be used.)

a. Equipment Setup and Initial Switch Positioning

1. Connect test equipment and position sweep generator controls as shown in Figure 4-1.
2. Position A3 PCB TEST-NORMAL switch to TEST. Access to this switch is permitted through a hole in the bottom panel of the network analyzer section. Reposition 560A upright.

Table 4-1. Recommended Test Equipment

INSTRUMENT	REQUIRED CHARACTERISTICS	RECOMMENDED MANUFACTURER
SWEEP GENERATOR	Horizontal output, blanking, and marker signals compatible with the 560A. Refer to Table 1-1. Frequency: 50 MHz*. Output Power: +10 dBm.	WILTRON Model 6647(A) Programmable Sweep Generator
DIGITAL VOLTMETER	4-1/2 digit readout.	Hewlett-Packard 3465A
POWER METER	50 MHz calibrated output.	Hewlett-Packard 435A
POWER SENSOR	Ability to handle 0 dBm.	Hewlett-Packard 8481A
POWER SUPPLY	+20V at 180 mA.	Hewlett-Packard 6215A
STEP ATTENUATOR	60 dB range.	Hewlett-Packard 355D
POWER AMPLIFIER	Gain: 10 dB; Output Power: 31 dBm	Anzac Model AM109
ATTENUATOR, 6 dB	SWR: 1.04 at 50 MHz. Accuracy: ± 0.05 dB	Weinschel 50-6
ATTENUATOR, 10 dB		Weinschel 50-10
ADAPTER	BNC jack to Type N plug.	Pamona Part No. 3288
ADAPTER	Type N jack to BNC plug.	Pamona Part No. 3535
CABLE, 12"	BNC to BNC.	Pamona P/N 2249-C-12
<u>Additional Equipment Required for GPIB PC Board Calibration:</u>		
OSCILLOSCOPE	20mV/division vertical sensitivity.	Tektronix 5103N/D10 with 5A15N and 5B10N
GPIB CONTROLLER	IEEE 488 (IEC 625-1) Interface.	Model 85 with: HP 82903A 16k Memory Module HP 82936A ROM Drawer HP 00085-15002 Plotter/Printer ROM HP 00085-15003 I/O ROM HP 00085-15004 Matrix ROM HP 82937A GPIB Interface

*50 MHz is used because (1) the 8481A Power Sensor is calibrated at this frequency and (2) the 355D Step Attenuator is more accurate at this frequency. (50 MHz is low enough in frequency that the 355D specifications for dc may be used.)

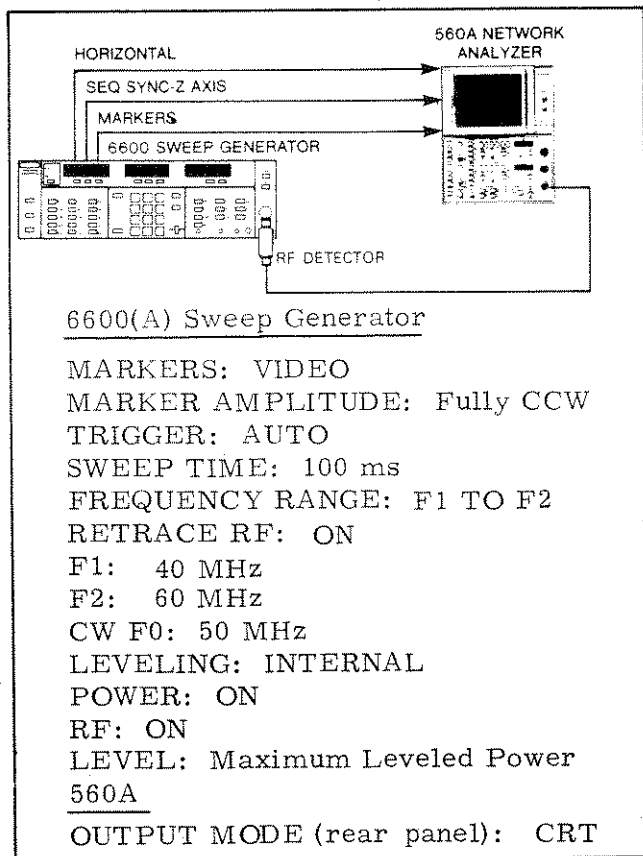

Figure 4-1. Test Setup for Performance Verification

CAUTION

On 560As where access to the TEST-NORMAL switch is via the hole in the bottom panel, use a short-shafted screwdriver to gently nudge the switch toward the center of the PCB. Do not press down on switch shaft with screwdriver blade. Applying pressure to switch shaft can damage switch.

NOTE

In the horizontal clamp test (subparagraph b, below), instructions will be given to adjust the CRT mainframe HORIZ POSITION potentiometer. The earth's magnetic fields may affect the horizontal

positioning of the CRT trace; consequently, the potentiometer should be adjusted with the 560A oriented in either the same position in which it will be used or the same position in which further testing will be conducted.

3. Position 560A controls as follows:

- CHANNEL A ON: On
- INPUT: R
- MEMORY: Off
- dB PER DIVISION: 17 (10, 5, & 2 depressed)
- REFERENCE dB/dBm: dBm
- OFFSET ZERO: Not depressed
- OFFSET: + 50.0
- CHANNEL B ON: Off
- INPUT: R
- MEMORY: Off
- dB PER DIVISION: 17 (10, 5, & 2 depressed)
- REFERENCE dB/dBm: dBm
- OFFSET ZERO: Not depressed
- MARKER THRESHOLD: Off
- REAL TIME: On
- REFRESH HOLD: Off
- SMOOTHING: Off
- POWER: On

b. Horizontal Clamp and CRT Mainframe HORIZ POSITION Adjustments

1. Adjust OFFSET to position trace so that both ends can be observed; see waveform below.

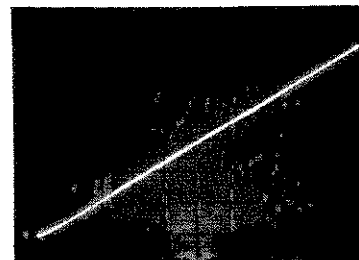

2. Adjust front panel HORIZ START screwdriver potentiometer until left end of trace begins to intensify and clamping starts. Clamping is indicated when the trace stops rising diagonally and either "shoots up" (right end) or "drops off" (left end) vertically. See waveform below.

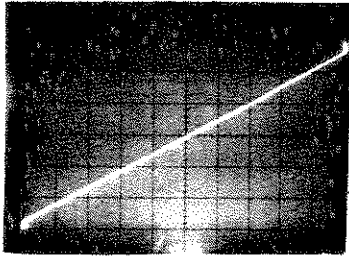

3. Adjust HORIZ STOP potentiometer until right end of trace starts clamping. An example of a properly adjusted waveform is shown below.

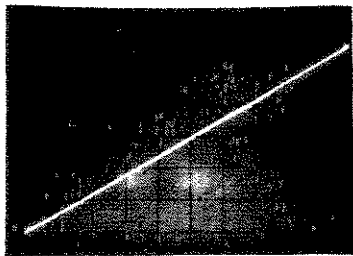

4. Press MANUAL SWEEP button (6647(A)); adjust MANUAL SWEEP control to low end of frequency band.
5. Connect DVM between 560A HORIZONTAL OUTPUT connector (rear panel) center conductor and chassis. Meter should indicate $0V \pm 0.2V$ (OUTPUT MODE switch in CRT position).
6. Adjust MANUAL SWEEP control (6647(A)) to high end of frequency band. DVM should indicate $+10.0 \pm 0.2 Vdc$. If meter does not indicate correct voltage, refer to HORIZ STOP troubleshooting chart, Figure 7-7.
7. Press AUTO button (6647(A)).
8. Depress INPUT A pushbutton lightly so that all three Channel A INPUT switches are released.
9. Rotate OFFSET control clockwise

until trace is positioned on center graticule line.

10. Adjust CRT mainframe HORIZ POSITION to position left end of trace on left graticule edge.
11. Adjust CRT mainframe X-Gain potentiometer (Figure 5-12) to position right end of trace on right graticule edge. The HORIZ POSITION and X-Gain potentiometers are interactive; repeat steps 10 and 11 until trace is positioned as shown below.

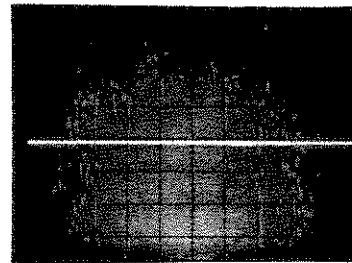

c. Refresh Horizontal Gain Test

1. Depress Channel A INPUT R.
2. Rotate OFFSET control counterclockwise for $+50.0$, as indicated on OFFSET dB display.
3. Depress CHANNEL B ON.
4. Adjust Channel B OFFSET for $+40.0$, as indicated on OFFSET dB display.
5. Depress REFRESH.
6. Adjust both OFFSET controls to position traces so that the start (left end) of Channel A refresh ramp (diagonal trace) and the finish (right end) of the Channel B refresh ramp can be observed. Channel A ramp should start on the left graticule edge, and the Channel B ramp should end on the right graticule edge. Traces should not be broken up (waveform A below) or flattened out at the right end (wave-

form B below). If traces are not as described, refer to paragraph 5-3.3.

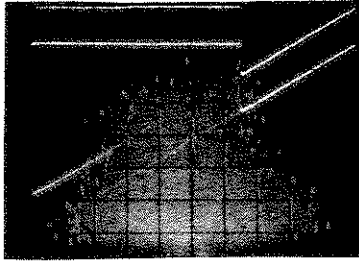

A

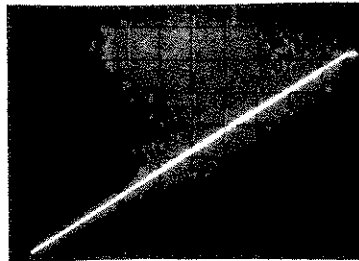

B

7. Readjust both OFFSET controls as required to observe the finish of both ramps. Both ramps should end at right graticule edge - see below. If traces do not end at right graticule edge, refer to paragraph 5-3.3.

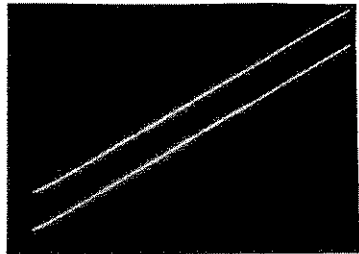

8. Depress CHANNEL B ON pushbutton (turn Channel B off).
9. Channel A ramp should finish at right graticule edge. If trace does not finish at right graticule edge, refer to paragraph 5-3.3.
10. Depress X-Y PLOT pushbutton and observe intensified dot as it moves

across CRT. If dot fails to reach right graticule edge, refer to paragraph 5-3.3.

d. Channel A and Channel B OFFSET ZERO tests

1. Depress Channel A and Channel B .2 dB PER DIVISION pushbuttons.
2. Depress REAL TIME.
3. Rotate OFFSET control clockwise for -00.0, as indicated on OFFSET dB display.
4. Depress INPUT A pushbutton lightly so that all three Channel A INPUT switches are released.
5. Depress REF POS LOCATE momentarily and insure that trace deflects to center graticule line.
6. Depress OFFSET ZERO; verify that trace deflects to center graticule line. If trace does not deflect as described, refer to paragraph 5-3.4.
7. Depress REF POS LOCATE momentarily and verify that trace does not deflect. If trace deflects, refer to paragraph 5-3.4.
8. Depress (release) OFFSET ZERO.
9. Depress Channel A INPUT R.
10. Depress CHANNEL A ON and CHANNEL B ON pushbuttons (turn Channel A off and Channel B on).

11. Repeat steps 3 thru 8 for Channel B.

e. CRT Mainframe Vertical Calibration

1. Rotate OFFSET control counterclockwise for +06.0, as indicated on OFFSET db display (CHANNEL B INPUT switches must be out; see step d4 above).
2. Depress 1 dB PER DIVISION pushbutton.

3. Depress and hold REF POS LOCATE and adjust SET potentiometer to position trace on next-to-top graticule line.
4. Release REF POS LOCATE. Trace should deflect to next-to-bottom graticule line. If trace does not deflect as described, refer to paragraph 5-3.5.
5. Rotate OFFSET control clockwise for -06.0, as indicated on OFFSET dB display.
6. Depress and hold REF POS LOCATE and adjust SET potentiometer to position trace on next-to-bottom graticule line.
7. Release REF POS LOCATE. Trace should deflect to next-to-top graticule line. If trace deflection is not as described, A2 PCB is faulty.
8. Depress and hold REF POS LOCATE and adjust SET potentiometer to position trace to center graticule line.
9. Release REF POS LOCATE.
10. Depress Channel B INPUT R.

f. Storage Memory Digital-to-Analog Converter Calibration

1. Rotate OFFSET control counterclockwise to position diagonal trace to center screen. See waveform below.

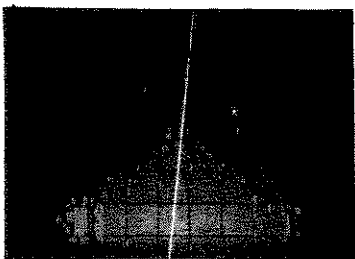

2. Depress STORE TRACE momentarily.
3. Depress RECALL. A digitized trace

similar to that observed in step 1 should be present. See waveform below.

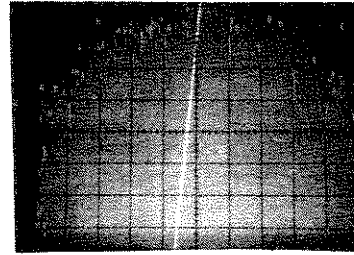

4. Depress 2 dB PER DIVISION push-button. A digitized trace that resembles a backwards Z should be present on CRT. If the horizontal elements of this backwards Z-shaped waveform are not positioned as shown in the waveform below (i.e., slightly above and slightly below the top and bottom graticule lines), refer to paragraph 5-3.6.

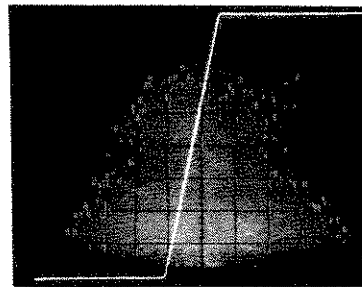

g. Vertical Analog-to-Digital Converter Calibration

1. Depress 10 dB PER DIVISION push-button.
2. Depress REFRESH.
3. Depress MEMORY OFF.
4. Depress STORE TRACE momentarily.
5. Depress SUBTRACT.
6. Depress .2 dB PER DIVISION push-button.
7. Observe CRT. A trace similar to

that shown below should be present near center-screen. The perturbations on the trace should not exceed 1-1/2 major divisions on either side of the center graticule line. If the trace is not as described, refer to paragraph 5-3.7.

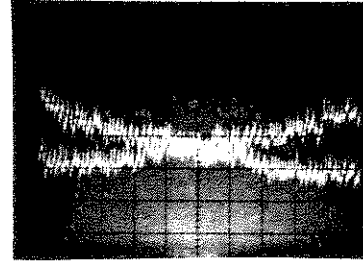
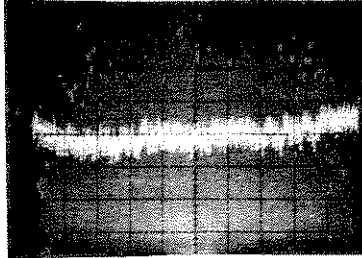

8. Depress MEMORY OFF.
9. Depress CHANNEL A ON pushbutton.
10. Depress Channel A and Channel B 10 dB PER DIVISION pushbuttons.
11. Rotate Channel A OFFSET control counterclockwise until Channel A trace is superimposed on Channel B trace.
12. Depress Channel A and Channel B STORE TRACE pushbuttons.
13. Depress Channel A and Channel B SUBTRACT pushbuttons.
14. Depress Channel A and Channel B .2 dB PER DIVISION pushbuttons.
15. Observe CRT. A criss-cross wave-form pattern similar to that shown below should be present. The ends of the Channel A and Channel B traces should be contained within the 6 major divisions that extend ± 3 divisions on either side of the center graticule line. If the traces are not as described, refer to paragraph 5-3.7.

h. Channel A and Channel B Memory and Subtract Balance

1. Depress Channel A and Channel B MEMORY OFF pushbuttons.
2. Depress CHANNEL A ON pushbutton (turn Channel A off).
3. Depress REAL TIME.
4. Depress INPUT B pushbutton lightly so that all three Channel B INPUT switches are released.
5. Rotate OFFSET control clockwise for -00.0, as indicated on OFFSET dB display.
6. Depress OFFSET ZERO. Trace should deflect to center graticule line.
7. Depress STORE TRACE momentarily.
8. Depress RECALL. Verify that trace does not deflect from center graticule line. If trace deflects, refer to paragraph 5-3.8.
9. Depress SUBTRACT. Verify that trace does not deflect from center graticule line. If trace deflects, refer to paragraph 5-3.8.
10. Depress (release) OFFSET ZERO.
11. Depress MEMORY OFF.

12. Depress Channel B INPUT R.
 13. Depress CHANNEL A ON and CHANNEL B ON pushbuttons. (Turn Channel A on and Channel B off.)
 14. Repeat steps 4 thru 11 for Channel A.
- i. Refresh Memory Digital-to-Analog Converter and Dot-Connector Calibration

1. Depress Channel A 5 dB PER DIVISION.
2. Depress and hold REF POS LOCATE and adjust SET potentiometer to position trace on next-to-bottom graticule line.
3. Release REF POS LOCATE.
4. Rotate OFFSET control clockwise to position trace on next-to-top graticule line (≈ -30.0 as indicated on OFFSET dB display).
5. Depress REFRESH.
6. Depress OFFSET ZERO. Trace should deflect to next-to-bottom graticule line. If trace deflection is not as described, refer to paragraph 5-3.9. Depress OFFSET ZERO.
7. Depress and hold REF POS LOCATE and adjust SET potentiometer to position trace on next-to-top graticule line.
8. Release REF POS LOCATE.
9. Rotate OFFSET control counterclockwise to position trace on next-to-bottom graticule line ($\approx +30.0$ as indicated on OFFSET dB display).
10. Depress OFFSET ZERO. Trace should deflect to next-to-top graticule line. If trace deflection is not as described, A2 PCB is faulty. Depress OFFSET ZERO.
11. Depress REAL TIME.

12. Set SWEEP TIME controls for a 10 s sweep.
13. Observe CRT and when intensified dot reaches the right of the screen, depress REFRESH.
14. Depress OFFSET ZERO; when refresh sweep starts, alternately release and depress OFFSET ZERO to obtain approximately 10 to 12 rectangular pulses on the CRT. At the conclusion of the refresh sweep, immediately depress REFRESH HOLD to save the display.
15. Observe CRT and verify that pulses are rectangular with no overshoot or ringing. See waveform below. If overshoot or ringing is present, refer to paragraph 5-3.9.

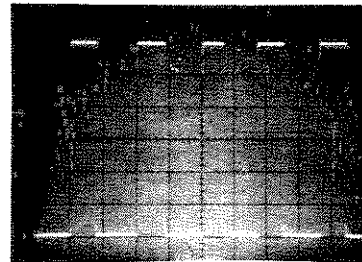

16. Depress X-Y PLOT.
17. Observe CRT. Intensified dot should trace the rectangular pulse pattern; there should be no overshoot or ringing. If overshoot or ringing is present, refer to paragraph 5-3.9.
18. Depress (release) REFRESH HOLD.
19. Set SWEEP TIME controls for a 100 ms sweep.
20. Depress REF POS LOCATE and adjust SET potentiometer to position trace on center graticule line.
21. Position A3 PCB TEST-NORMAL switch to NORMAL.

22. Reinstall bottom cover (if necessary).
23. Remove RF detector from between sweeper and 560A.

POWER ACCURACY TESTS

Power Accuracy Verification is divided into 2 tests. The first test verifies the most common measurement range, +10 to -50 dBm, and is contained in steps j thru q. This test requires only two additional items of test equipment: (1) a power meter/power sensor and (2) a step attenuator.

The second test verifies power accuracy at +16 dBm and is provided in steps r and s. This test requires an RF power amplifier, a dc power supply, and two attenuators in addition to the power meter/power sensor.

Unless the 560A is going to be used at +16 dBm, verification at this power level is not necessary - skip steps r and s and proceed to step t.

j. Power Meter/Power Sensor Calibration at 50 MHz

1. Position CAL FACTOR control on power meter to the correct power factor (see chart on power sensor).
2. Position the RANGE control to 1mW.
3. Connect power sensor to POWER REF connector. Adjust CAL ADJ screwdriver potentiometer to position meter pointer on CAL mark.
4. Disconnect power sensor from POWER REF connector.

k. Sweep Generator/Step Attenuator Output Power Calibration

1. Set FREQUENCY RANGE to CW F0 (6647(A)).
2. Set LEVEL to +10 dBm (6647(A)).

3. Position attenuation dial on 355D to 10.
4. Connect equipment as shown in Figure 4-2 below.

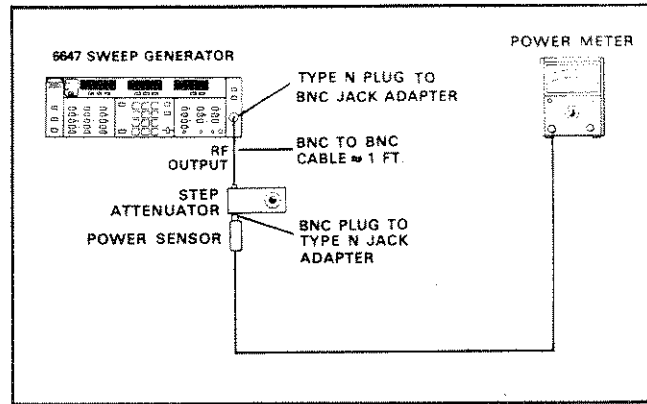

Figure 4-2. Test Setup for Sweep Generator/Step Attenuator Output Power Calibration

5. Set FREQUENCY RANGE to F1 TO F2 (6647(A)).

m. Channel A Low Level Calibration

1. Connect RF detector to front panel connector A. (Leave detector unconnected from RF source.)

NOTE

Ensure that bottom cover is installed.

2. Depress SMOOTHING to MAX.
3. Depress INPUT A.
4. Rotate OFFSET control clockwise to -58.0, as indicated on display.
5. Depress 1 dB PER DIVISION push-button.
6. On right side panel, adjust CH A (LOW LEVEL TRIM) control as follows:

- (a) If trace is below center graticule line, rotate potentiometer counterclockwise until trace is slightly above center line and exhibits only random negative clipping. See waveform below.

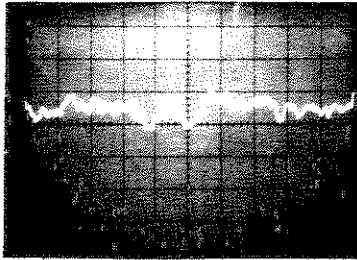

- (b) If trace is either above center graticule line or off-screen, rotate potentiometer clockwise until trace is positioned as described in (a) above.

3. Depress .2 dB PER DIVISION push-button.
 4. Construct a chart similar to that shown below in Table 4-2.
 5. Operate the chart of Table 4-2 as follows:

- (a) Position 355D to first Attenuator Dial Setting.
 (b) Adjust OFFSET control to position center of trace (50 MHz) coincident with center of graticule cross-hairs on CRT; see waveform below.

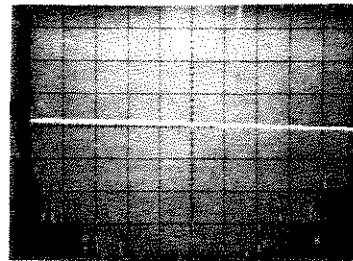

- (c) Record OFFSET dB display value in OFFSET dB Reading column.
 (d) Repeat steps (a) thru (c) for re-

n. Channel A Power Accuracy Test

1. Rotate OFFSET control counterclockwise to +10.0, as indicated on display.
 2. Connect RF detector to output connector of 355D.

Table 4-2. Power Accuracy Chart

Attenuator Dial Setting	Input Power Level (dBm)	OFFSET dB Reading	Limits (dBm)
0	+10		+10.6 to + 9.5
10	0		+ 0.7 to - 0.5
20	-10		- 9.4 to -10.6
30	-20		-19.3 to -20.6
40	-30		-29.2 to -30.7
50	-40		-39.2 to -40.8
60	-50		-49.1 to -50.9*

*If power accuracy reading is not within limits, recheck Channel A Low Level Calibration (subparagraph m above).

maining Attenuator Dial Settings.

- (e) If any of the power accuracy readings are out of tolerance, refer to paragraph 4-4 for instructions on how to interpret the chart in Table 4-2.

o. Channel B Low Level Calibration

1. Depress CHANNEL A ON and CHANNEL B ON pushbuttons (turn Channel A off and Channel B on).
2. In subparagraph m, repeat step 1 and steps 3 thru 6 for Channel B.

p. Channel B Power Accuracy Test

Repeat subparagraph n, steps 1 thru 5 for Channel B.

q. Channel R Power Accuracy Test

1. Disconnect RF detector from B and move to R connector.
2. Depress Channel B INPUT R pushbutton.
3. Rotate OFFSET control counterclockwise for +10.0, as indicated on OFFSET dB display.

NOTE

The output signal from the R channel log amplifier is processed by the A1/A2 PCB Channel B circuits and displayed on Channel B trace.

4. Repeat subparagraph n, steps 1 thru 5 for Channel R except: for Channel R complete the chart in Table 4-2 only thru Attenuator Dial Setting 40. The R channel has a power measurement range of +16 to -30 dBm.

r. +16 dBm Power Accuracy Test Setup Output Power Calibration

1. Set FREQUENCY SELECTOR to CW F0 (6647(A)).
2. Set RF output at 6 dBm.
3. Connect equipment as shown in Figure 4-3.

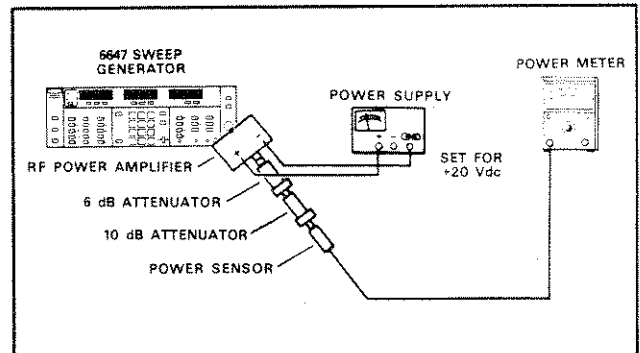

Figure 4-3. Equipment Setup, +16 dBm Verification

4. Disconnect power sensor from 10 dB attenuator.
5. Remove both attenuators from test setup and connect RF detector to output of power amplifier.
6. Set FREQUENCY SELECTOR to F1 TO F2 (6647(A)).

s. +16 dBm Power Accuracy Test

1. Rotate OFFSET control counterclockwise to +16.0, as indicated on OFFSET dB display.
2. Adjust OFFSET control to position center of trace (50 MHz) on center of graticule crosshairs on CRT.
3. Record the OFFSET dB display value. This reading, which is the R channel power accuracy at +16 dBm, should fall between +16.8 and +15.7 dBm.

4. Move RF detector to front panel connector B.
5. Repeat steps 2 and 3 above for Channel B (the same accuracy limits apply).
6. Depress CHANNEL A ON and CHANNEL B ON (turn on Channel A and turn off Channel B).
7. Move RF detector to front panel connector A.
8. Repeat steps 2 and 3 above for Channel A (the same accuracy limits apply).

t. Smoothing Verification Tests

1. Position RF ON switch to off (6647).
2. Depress 2 dB PER DIVISION.
3. Disconnect RF detector from R connector and move to B connector.
4. Depress INPUT B.
5. Adjust OFFSET control for -58.0, as indicated on OFFSET dB display.
6. Depress SMOOTHING to OFF, MIN, and MAX and observe trace at each position. Trace should exhibit a change in noise level (see waveforms A, B, and C below). If no change in noise is observed, the A3 PCB is faulty.

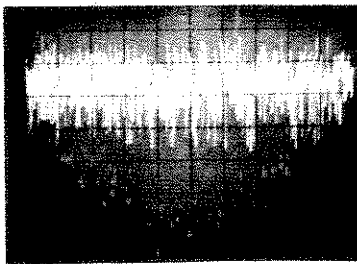

A - SMOOTHING OFF

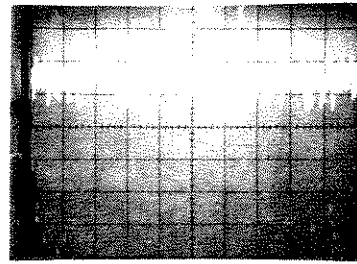

B - SMOOTHING MIN

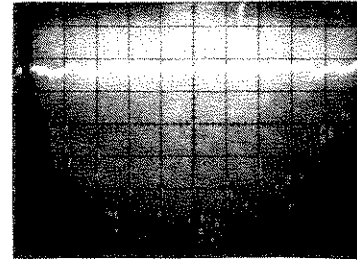

C - SMOOTHING MAX

u. Marker Verification Tests

1. Position RF ON switch to ON (6647).
2. Rotate OFFSET control counter-clockwise for ± 00.0 on OFFSET dB display.
3. Position attenuation dial on 355D to 10.
4. Depress the 5 dB PER DIVISION pushbutton.
5. Rotate MARKER AMPLITUDE control fully clockwise (6647).
6. Rotate MARKER THRESHOLD control (560A) clockwise out of detent until marker pulse appears on trace. If no marker appears on trace, refer to Marker Malfunction Troubleshooting Chart, Figure 7-13.
7. Rotate TILT control throughout its range. Marker should tilt ± 45 de-

grees. If marker does not tilt, A1 PCB is faulty.

4-3.3 Performance Verification Procedure (Option 3--GPIB)

The procedure for verifying 560A GPIB Interface (A6) PCB performance is given below. This procedure assumes the 560A performance to be within specified limits; consequently, the procedures in paragraph 4-3.2 should be completed first. The A6 PCB test setup and initial control positioning requirements for the sweep generator are shown in Figure 4-4. To verify the performance of the A6 PCB, proceed as follows:

- a. Power Meter/Power Sensor Calibration at 50 MHz (Refer to Performance Verification Procedure, paragraph 4-3.2j.)
- b. Sweep Generator/Step Attenuator Output Power Calibration (Refer to Performance Verification Procedure, paragraph 4-3.2k.)
- c. Initial Positioning of 560A Controls

CHANNEL A ON: On
 INPUT: A
 MEMORY: Off
 dB PER DIVISION: 1
 REFERENCE dB/dBm: dBm
 OFFSET: -58.0
 OFFSET ZERO: Not depressed
 CHANNEL B ON: Off
 INPUT: B
 MEMORY: Off
 dB PER DIVISION: 1
 REFERENCE dB/dBm: dBm
 OFFSET ZERO: Not depressed
 MARKER THRESHOLD: Off
 REFRESH: On
 REFRESH HOLD: Off
 SMOOTHING: MAX
 POWER: On

d. Channel A Low-Level Calibration

1. Connect RF detector to front panel A connector. (Leave detector unconnected from RF source.)

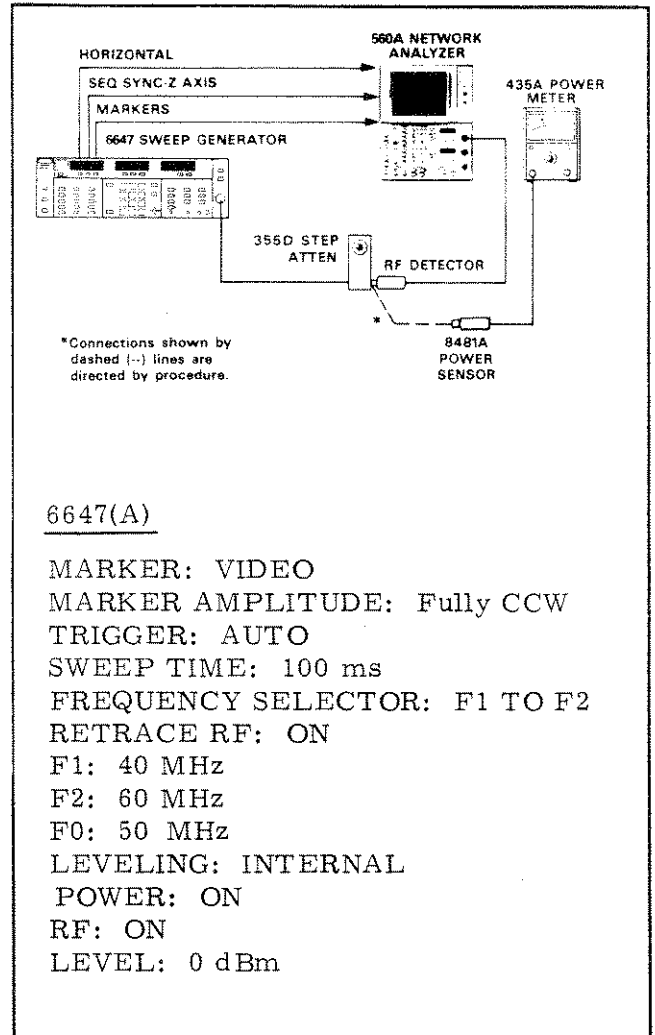
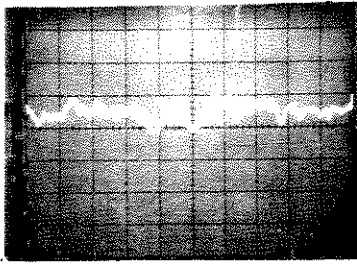

Figure 4-4. Equipment Setup for A6 PCB Performance Verification

2. Depress and hold REF POS LOCATE and adjust SET potentiometer to position trace on center graticule line.
3. Release REF POS LOCATE.
4. Adjust CH A side panel control as follows:
 - (a) If trace is below center graticule line, rotate potentiometer counter-clockwise until trace is slightly above center graticule line and exhibits only random negative clipping. See waveform below.



(b) If trace is either above the center graticule line or off-screen, rotate potentiometer clockwise until trace is positioned as described in step (a), above.

e. GPIB Controller Readout/560A OFFSET dB Display Tracking Tests

1. Set FREQUENCY RANGE to CW F0 (6647(A)).
2. Adjust attenuator dial on 355D to 0.
3. Program controller (1) for maximum smoothing, and (2) to take data continuously from Channel A. See flowchart in Figure 4-5. A computer program that implements this flowchart is provided in Figure 4-6; this program is written in HPL for use with the HP 9825A Programmable Calculator.

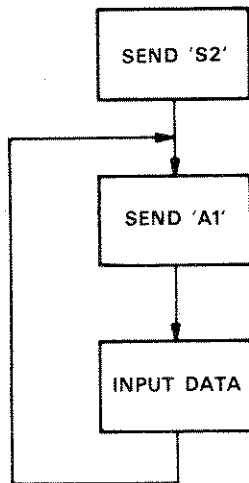

Figure 4-5. Flowchart for Programming SMOOTHING MAX (S2) and Continuous Data Readout on Channel A

```

0: wrt 706, "S2"
1: wrt 706, "A1"
2: red 706, X
3: dsp X
4: wait 50
5: ato 1
  
```

Figure 4-6. GPIB Program in HPL for HP 9825A Controller

4. Rotate OFFSET control on 560A counterclockwise to position intensified dot at left side of CRT on center graticule line. The OFFSET dB display should indicate between +10.6 and +09.5 ± 1 digit; the readout on the controller should indicate the same value as that shown on the OFFSET dB display ± 0.1 dB. Example: OFFSET dB display indicated +10.1; controller should indicate between +10.00 and +10.20. If reading is not correct, refer to paragraph 5-5 for calibration procedure.
5. Repeat step 4 for 355D attenuator dial settings of 10 thru 60. At each attenuator dial setting, OFFSET dB display readout should be within the limits specified in Table 4-2. To compensate for noise at the lower power levels (i. e., -40 and -50 dBm), it may be necessary to average approximately 100 readings to meet the specified tolerance. If readout is not as specified, refer to paragraph 5-5 for calibration procedure.

f. -30 dBm Comparator Trip Point Test

1. Adjust attenuator dial on 355D to 10 (0 dBm). Observe controller display and make a mental note of the rate at which readout digits change (readout rate).
2. Rotate attenuator dial counterclockwise to 40 (-30 dBm). The controller readout rate should slow. If readout rate does not slow, refer to paragraph 5-5 for calibration procedure.

3. Increase RF output of sweeper until controller readout rate increases. The increase in the readout rate should occur around -29.5 dBm (-29.50 on controller readout). If test is not as specified, proceed to paragraph 5-5 for calibration procedure.

g. +/- Sign Change Trip Point Test

1. Rotate attenuator dial on 355D clockwise to 10.
2. Disconnect RF detector from 355D; connect power sensor in its place.
3. Set RF output for a 0 dBm reading on power meter.
4. Disconnect power sensor from 355D and reconnect RF detector.
5. Decrease and then increase the RF output of the sweeper. The sign of the readout digits, as shown on the controller display, should change as the RF power level is varied approximately 0.05 dB either side of 0 dBm. If test result is not as specified, refer to paragraph 5-5 for calibration procedure.

h. Smoothing Sequencer Test

1. Rotate attenuator dial on 355D counterclockwise to 50 (-40 dBm).
2. Observe SMOOTHING indicators on 560A front panel. The MAX indicator should appear to be lit continuously, and the OFF indicator should be flashing. If test results are not as specified, A6 PCB is faulty.

i. Settling Time Determination Tests

1. Referring to flowchart in Figure 4-7 or program in Figure 4-8, program the controller to (1) send a fast mode (FM) command and (2) take 1000 read-

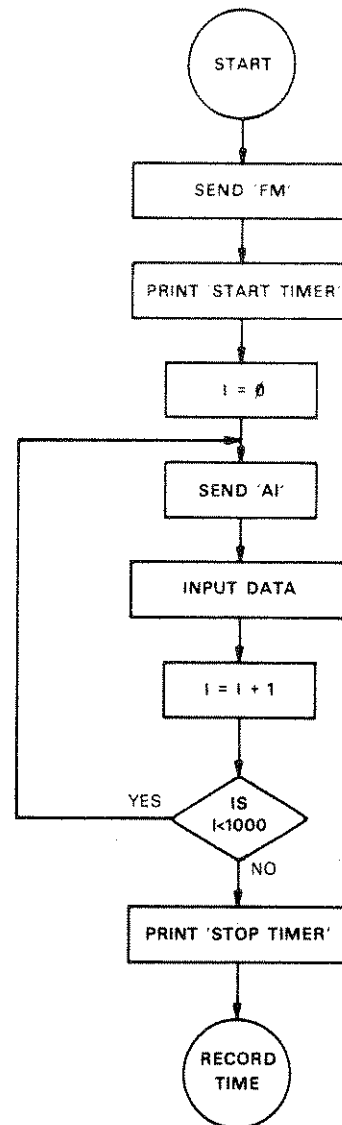

Figure 4-7. Flowchart for Programming 560A to Return 1000 Readings of Channel A Data

ings of Channel A data. Use a stopwatch to measure the time between "START TIMER" and "STOP TIMER" in the controller program. Record this time, for it will be used as a reference time for S0, S1 and S2 measurements. (This time is the inherent time delay of the controller/560A GPIB system.)

2. Program controller to (1) send hold

mode (HM) command, (2) send smoothing off (SØ) command, and (3) take 1000 readings of Channel A data. (In flowchart of Figure 4-7, change "FM" to "HMSØ" and rerun program.) Use a stopwatch to measure the time between "START TIMER" and "STOP TIMER" in controller program. Subtract the time measured in step 1 from the time measured in this step. The difference between these two times should be 12 ± 2 seconds. If the time is not 12 ± 2 seconds, the A6 PCB is faulty; there is no adjustment for this time delay.

3. Program controller for smoothing 1 (substitute "S1" for "SØ" in flowchart) and repeat step 2. The time should be 40 ± 6 seconds. As in step 2 above, if this time is incorrect the A6 PCB is faulty.
4. Program controller for smoothing 2 (substitute "S2" for "S1" in flowchart) and repeat step 2. The time should be 200 ± 30 seconds. As in step 2 above, if this time is incorrect the A6 PCB is faulty.

```

0: wrt 706, "FM"
1: prt "Start
   timing with
   the first beep
   ."ispc
2: prt "Stop
   timing with the
   second beep."i
   spc 3
3: 0+1
4: wait 50ibeep
5: wrt 706, "AI"
6: red 706, X
7: 1+1+1
8: if 1<1000;
   ato 5
9: beep;prt "Sto
   o timing."ispc
   3
10: wrt 706, "RL"
11: stop

```

Figure 4-8. GPIB Program in HPL for Taking 1000 Readings of Measurement Data

4-4 POWER ACCURACY MEASUREMENT CHART

This paragraph describes the power accuracy measurement chart that appears in paragraph 4-3.2 n. of the Performance Verification Procedure. This description is divided into two areas: (1) a description and listing of the possible error sources inherent in the power measurement system of paragraph 4-3.2, and (2) recommended courses of action, should one or more power accuracy readings be out of tolerance.

4-4.1 Error Sources Inherent in Performance Verification Procedure Power Measurement System

The power measurement system (i. e., power meter, sweep generator, step attenuator, and RF detector) in paragraph 4-3.2 contains several inherent possible error sources. A listing of these error sources is given below; the degree to which these error sources contribute to measurement uncertainty is given in Table 4-3.

- a. Detector/Source Match Interaction Error. The impedance mismatch between the RF source and the RF detector contributes a possible error known as source match. For the Model 6647(A) Programmable Sweep Generator and the 560-7 series detectors, this error is: At +10 dBm (355D Attenuator Dial at 0), the source match of the sweeper and the mismatch of the RF detector interact to produce an overall error of 0.28 dB. At 0 dBm and below (355D Attenuator Dial between 10 and 60), the source match of the 355D and the RF detector interact to produce an error of 0.14 dB.
- b. Harmonic Frequency Error. In the linear range of the RF detector, i. e., +16 dBm to approximately -15 dBm, harmonics of the sweep generator fundamental frequency contribute possible errors in measurements.
- c. Step Attenuator Error. The HP 355D Step Attenuator has a specified accuracy of ± 0.3 dB from dc to approximately 50 MHz. This possible error in accuracy is present at all attenuator dial

settings, including zero.

- d. Model 560-7 or 560-71 Series RF Detectors Frequency Sensitivity Error.
This possible error source varies with frequency and is graphically shown in Table 1-3.
- e. A and B Log Amplifier Accuracy Error.
This possible error source varies with input power; it is graphically shown in Table 1-1.

4-4.2 Recommended Courses of Action for Power Accuracy Out-of-Tolerance Conditions

The Channel A and B accuracy potentiometers (R154 and R181), along with those for Channel R (R230 and R294), are critical adjustments. These potentiometers should not be adjusted until all of the other possible-error-producing sources have been checked, or, in the case of the 560 detectors, until the possible-error sources

Table 4-3. Possible Errors Inherent in Power Measurement System of Paragraph 4-3.2

Input Power (dBm)	Possible Error (dB) at 50 MHz					RMS Error*
	Det./Source Match Interaction	Harmonic Frequency at 30 dBc	Attenuator Accuracy	Detector Frequency Sensitivity	Log Amp Accuracy	
+16	±0.31	+0.6 -0.4	±0.04	+0.3 -0.2	±0.4	+0.8 -0.7
+10	±0.28	+0.3 -0.2	±0.3	+0.3 -0.2	±0.2	+0.6 -0.5
0	±0.14	+0.3 -0.2	±0.3	+0.3 -0.2	±0.3	+0.7 -0.5
-10	±0.14	+0.15 -0.1	±0.3	+0.3 -0.2	±0.4	±0.6
-20	±0.14	+0.15 -0.1	±0.3	+0.3 -0.2	±0.5	+0.7 -0.6
-30	±0.14	+0.15 -0.1	±0.3	+0.3 -0.2	±0.6	+0.8 -0.7
-40	±0.14	+0.15 -0.1	±0.3	+0.3 -0.2	±0.7	±0.8
-50	±0.14	+0.15 -0.1	±0.3	+0.3 -0.2	±0.8	±0.9

*The rms error is found by squaring the individual errors, summing them, and taking their square root. The rms error for +10 dBm would be as follows:

$$\sqrt{(0.28)^2 + (0.3)^2 + (0.3)^2 + (0.3)^2 + (0.2)^2} = 0.62, \text{ or } 0.6.$$

have been isolated from the 560A input. Therefore, the following should be performed before the accuracy adjustments are attempted.

a. If any of the power accuracy readings for Channel A (or B) are out of tolerance, perform the Channel B (or A) low-level calibration and power accuracy tests in paragraph 4-3.2. After performing the Channel B (or A) tests:

1. If Channel A (or B) is out of tolerance but Channel B (or A) is not, perform the Channel A (or B) checks and adjustments in paragraph 5-4.1. After performing these checks and adjustments, recheck Channel A (or B) power accuracy.

2. If both channels' power accuracy readings are out of tolerance:

- (a) Try a different RF detector.
- (b) Try a different 355D Step Attenuator.
- (c) Perform the power accuracy test in paragraph 4-5.

b. If only the -50 dBm power accuracy readings (60 on step attenuator dial) are out of tolerance, recheck the appropriate channel's low-level calibration (paragraph 4-3.2 m and/or o).

c. If the R input power accuracy readings are out of tolerance, perform the Channel R checks and adjustments of paragraph 5-4.1. After performing these checks and adjustments, recheck Channel R power accuracy.

4-5 POWER ACCURACY TEST USING DC VOLTAGE STANDARD

This test uses highly-accurate (0.0005%) dc voltages to simulate input RF power for 560A power accuracy verification. The test in this paragraph may be used to isolate the RF detector as a possible-error-producing source in log amplifier power

accuracy tests. To connect the dc voltages to the log amplifier input requires a special connector test jig. Instructions, along with a parts list, for building this connector test jig are given in Figure 4-9. The EDC Model 501 DC Power Supply (Table 4-1) may be used to supply the dc voltages. To perform this test, proceed as follows:

a. Connect equipment, with the exception of the RF detector, as shown in Figure 4-1 (page 4-3).

b. Position 560A controls as follows:

CHANNEL A ON: On
INPUT: A
MEMORY: Off
dB PER DIVISION: .2
REFERENCE dB/dBm: dBm
OFFSET: See Table 4-4
OFFSET ZERO: Not depressed

CHANNEL B ON: Off
INPUT: B
MEMORY: Off
dB PER DIVISION: .2
REFERENCE dB/dBm: dBm
OFFSET ZERO: Not depressed

MARKER THRESHOLD: Off
REFRESH: On
REFRESH HOLD: Off
SMOOTHING: MAX

c. On 560A, press REF POS LOCATE and adjust the SET potentiometer to position trace on center graticule line.

d. Connect the special connector test jig (Figure 4-9) to the front panel "A" connector.

e. Connect the black lead of the test jig to the negative (-) terminal on the floating-ground power supply.

f. Connect the red lead of the test jig to the positive (+) terminal on the floating-ground power supply.

g. Connect the shield lead of the test jig to the ground terminal on the floating-ground power supply.

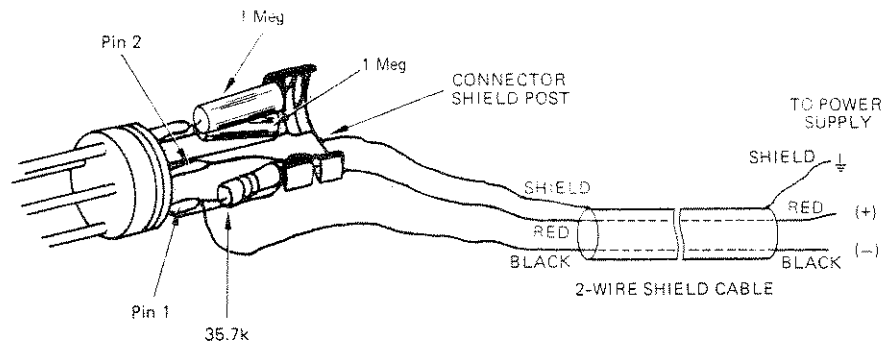

Fabricate special connector test jig as follows:

1. Solder one end of the 35.7 k Ω resistor to pin 1. Solder the other end of the 35.7 k Ω resistor to the shield post and to pin 2.
2. On the 2-wire shielded cable, solder the black lead to pin 1. Solder both the red and shield leads to the connector shieldpost.
3. Solder 1 M Ω resistor to pin 3. Solder the other resistor lead to shieldpost.
4. Solder 1 M Ω resistor to pin 4. Solder the other resistor lead to shieldpost.

Special Connector Parts List

Part Description	Part Number	Vendor
Connector, Plug	09CL4M	Switchcraft, Inc.
Shielded Wire, 2-conducted, 22 ga.	2464	Belden
Resistor, Metal Film, 1 M Ω , 1/8W, 0.1% (2 each)	EMF55T9-1 Meg-0.1% RNC55J1DO4BS	Dale Elect. Mil. Spec.
Resistor, Metal Film, 35.7 k Ω , 1/8W, 1/8W, 0.1%	EMF55FT9-35.7k-0.1%	Dale Elect.

Figure 4-9. Fabrication Instructions for Special Connector Used With DC Voltage Standard

h. On the power supply, adjust the controls to provide voltage number 1 in Table 4-4.

i. On 560A, adjust OFFSET to position trace on center graticule line. The OFFSET dB display should read the dBm value that corresponds to voltage number 1 in Table 4-4.

j. Repeat steps h and i for the remaining voltages in Table 4-4.

NOTE

Trace instability at -40 and -47 dBm (Table 4-3) may be due to thermocouple-induced voltages and 60-hertz noise.

Table 4-4. Equivalency Chart,
DC Voltage to dBm

DC Voltage	OFFSET dB Reading
1. -1.462V	+16, ±0.2
2. -0.6208V	+9, ±0.2
3. -0.2449V	+2, ±0.2
4. -86.94 mV	-5, ±0.2
5. -26.13 mV	-12, ±0.2
6. -6.268 mV	-19, ±0.2
7. -1.313 mV	-26, ±0.2
8. -263.0 μ V	-33, ±0.2
9. -52.0 μ V	-40, ±0.3
10. -10.0 μ V	-47, ±0.3

SECTION V CALIBRATION

5-1 INTRODUCTION

This section provides calibration instructions for the Front Panel (A1), Digital (A2), Log Amplifier (A3), and optional GPIB Interface (A6) PCBs. The instructions in this section should not be performed unless the performance verification instructions in Section IV indicate that an out-of-tolerance condition exists.

5-2 GAINING ACCESS TO THE 560A PRINTED CIRCUIT BOARDS

The 560A Scalar Network Analyzer is produced in two configurations, horizontal and vertical (Option 2), and is composed of two main assemblies, network analyzer and CRT mainframe. The network analyzer and CRT mainframe PCBs in either 560A configuration are readily accessible. How to gain access to these PCBs is described below:

Horizontal Configuration

To gain access to the network analyzer PCBs, remove the two straight brackets and the two left-corner brackets from the rear of the 560A (Figure 5-1), and slide the bottom cover to the rear; to gain access to the CRT mainframe PCBs, remove the two right-corner brackets in addition to the two straight brackets, and slide the top cover to the rear.

Vertical Configuration

To gain access to the network analyzer PCBs, remove the two straight brackets and the two bottom-corner brackets from the rear of the 560A (Figure 5-2), and slide the bottom cover to the rear; to gain access to the CRT mainframe PCBs, remove the two top-corner brackets in addition to the two straight brackets, and slide the top

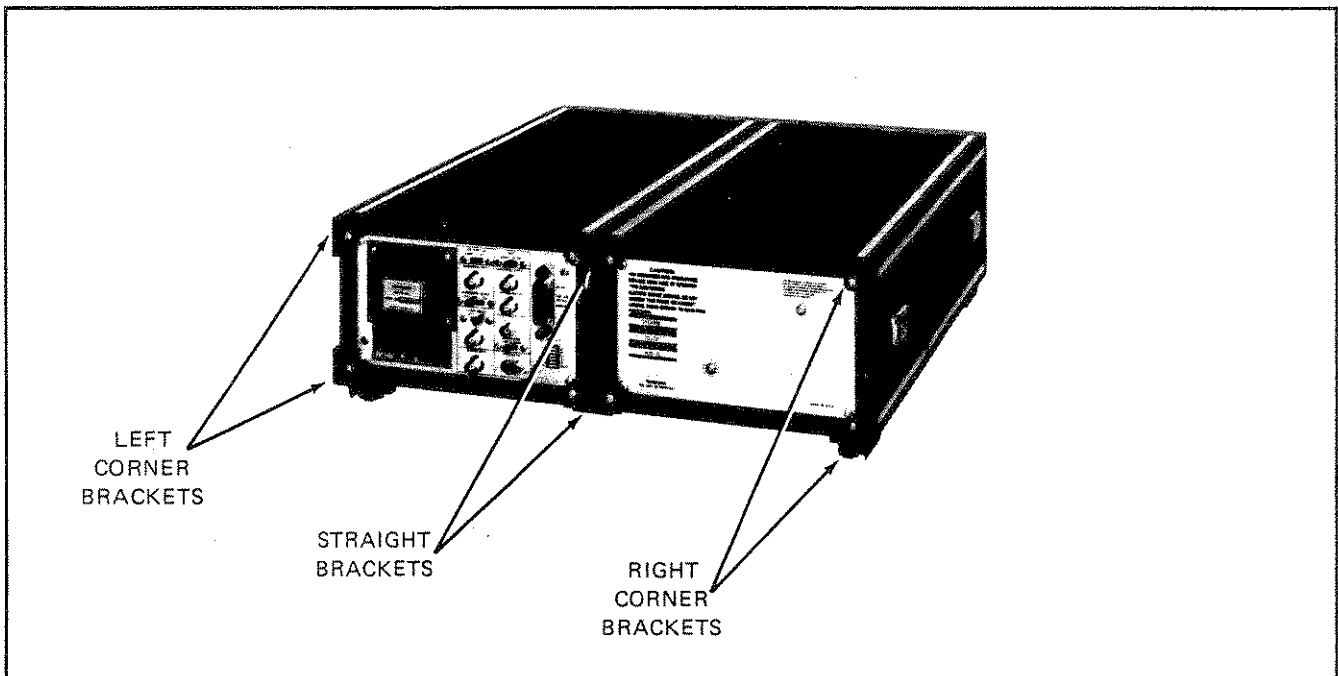

Figure 5-1. Rear Panel Brackets, 560A Horizontal Chassis

cover to the rear. Figure 5-3 shows a vertical chassis with the network analyzer PCBs exposed.

5-3 FRONT PANEL (A1) AND DIGITAL (A2) PCB ADJUSTMENTS

The adjustments required to calibrate the

front panel and digital PCB circuits are described in the following paragraphs. The calibration of these two PCBs requires a digital voltmeter and a sweep generator. The sweep generator interconnections and initial control positioning for the WILTRON 6647(A) Programmable Sweep Generator are

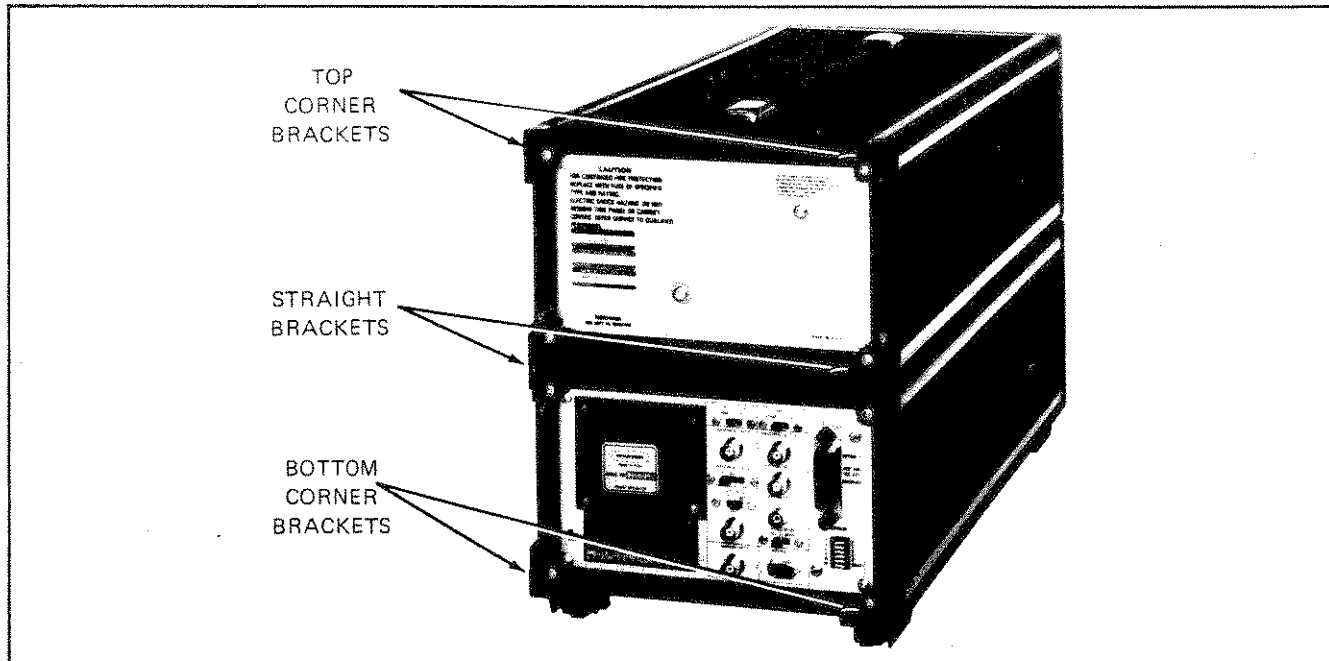

Figure 5-2. Rear Panel Brackets, 560A Vertical Chassis

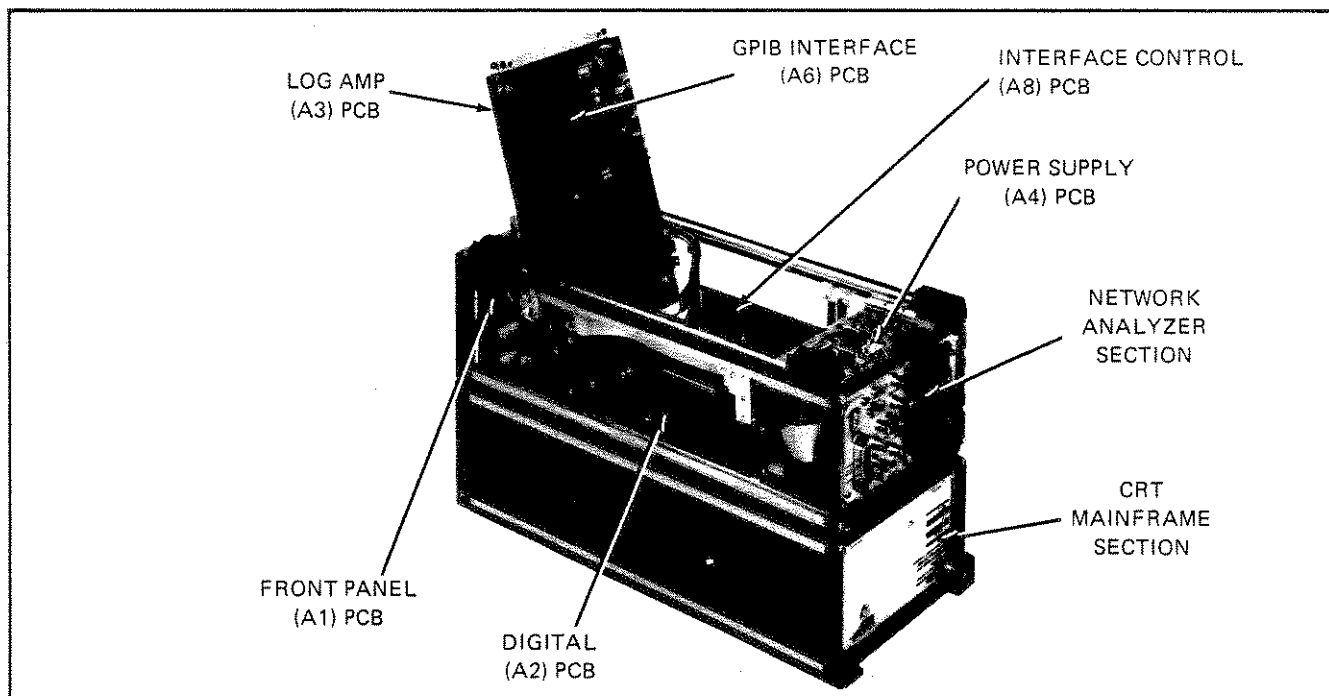

Figure 5-3. Vertical Chassis With Network Analyzer Exposed

shown in Figure 5-4.

NOTE

Reference to top and bottom of the CRT in the following procedures is viewed with the 560A upside down (Figure 5-3).

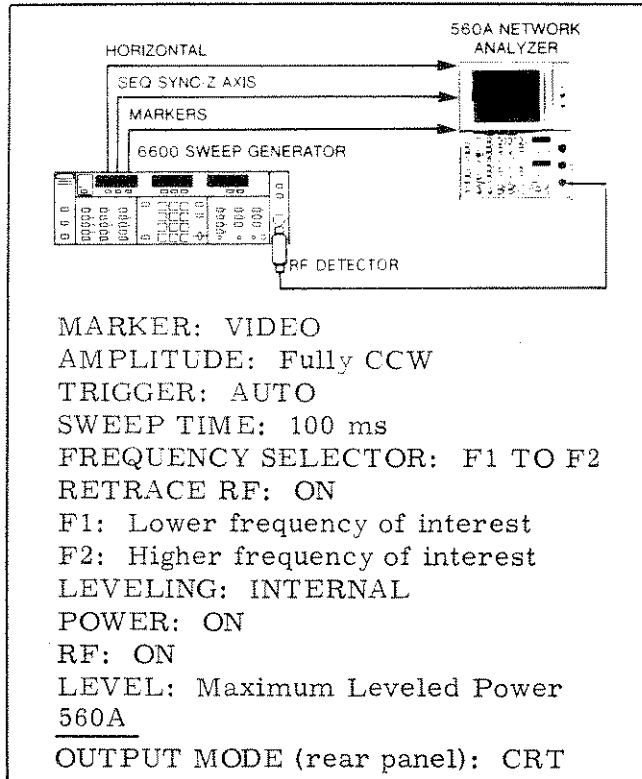

Figure 5-4. Digital PCB Calibration Equipment Setup Using WILTRON 6600(A) Series Programmable Sweep Generator

5-3.1 Power Supply Checks and OFFSET dB Display Reference Voltage Check and Adjustment

This paragraph provides instructions for checking the +15V, -15V, and +5V power supply output voltages, plus the +1.000Vdc input reference voltage for the Channel A and Channel B OFFSET dB digital voltmeter displays. Instructions for adjusting the OFFSET dB reference voltage are also included. The power supply voltage checks contain no corresponding adjustment instructions; there are no adjustments for these voltages. If any of the three power

supply voltages are out of tolerance, the power supply (A4) PCB is faulty. To perform voltage checks, proceed to subparagraph a, below. If the +1.000 volt OFFSET dB display reference voltage is out of tolerance, perform the voltage adjustment outlined in subparagraph b, below.

a. Voltage Checks

1. Connect 560A to sweep generator and position sweep generator controls as shown in Figure 5-4.
2. Gain access to the network analyzer digital and front panel PCBs; refer to paragraph 5-2.
3. Depress POWER pushbutton.
4. Connect DVM test leads to A2TP1 (common) (see Figure 5-14 for location) and A2TP2. Verify that meter indicates $+15.0 \pm 0.6$ Vdc.
5. Connect DVM test leads between A2TP1 (common) and A2TP3. Verify that meter indicates -15.0 ± 0.6 Vdc.
6. Connect DVM test leads between A2TP1 (common) and A2TP4. Verify that meter indicates $+5.0 \pm 0.2$ Vdc.
7. Connect DVM test leads between A1TP1 (see Figure 5-13 for location) and A1TP2 (common). Verify that meter indicates $+1.000V \pm 1.0$ mVdc.



To adjust A1R73 in b below, use a tubular adjustment tool with a recessed screwdriver tip (General Cement (GC) part number 8276, or equivalent). A1R73 is difficult to reach; the use of a normal screwdriver may result in the screwdriver's slipping from the potentiometer screw slot and damaging the A1 PCB.

- b. OFFSET dB Reference Voltage Adjustment. With DVM connected between A1TP1 and A1TP2, adjust potentiometer A1R73 for +1.000Vdc.

5-3.2 Horizontal Clamp and CRT Mainframe HORIZ POSITION and X-Gain Adjustments

This paragraph provides instructions for aligning the CRT mainframe horizontal deflection with the network analyzer normalized 0-10V input horizontal sweep ramp. To perform these adjustments, proceed as follows:

- a. Perform voltage checks per paragraph 5-3.1.
- b. Position 560A controls as follows (controls not identified may be in any position):

CHANNEL A ON: On
 INPUT: R
 MEMORY: Off
 dB PER DIVISION: 17 (10, 5, & 2 depressed)
 REFERENCE dB/dBm: dBm
 OFFSET ZERO: Not depressed
 OFFSET: +50.0
 MARKER THRESHOLD: Off
 REAL TIME: On
 SMOOTHING: Off

- c. Position A3 PCB TEST-NORMAL switch to TEST.
- d. Adjust OFFSET to position trace so that both ends can be observed; see waveform below.

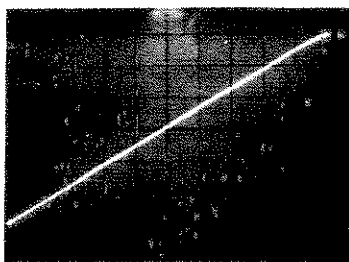

- e. Adjust front panel HORIZ START screwdriver potentiometer until right end of trace, as observed on CRT, begins to

intensify and clamping starts. Clamping is indicated when the trace stops rising diagonally and either "shoots up" (right end) or "drops off" (left end) vertically. See waveform below.

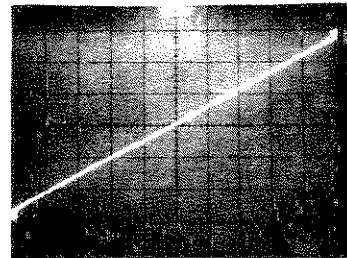

- f. Adjust HORIZ STOP potentiometer until left end of trace starts clamping. An example of a properly adjusted waveform is shown below.

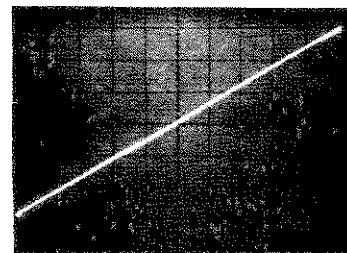

- g. Select manual sweep on sweep generator to Manual and adjust its control fully CCW (to low end of band). Connect DVM between HORIZONTAL OUTPUT, on rear panel of 560A, and chassis. Meter should indicate zero ± 0.2 volts (OUTPUT MODE switch in CRT position).
- h. Adjust manual sweep control fully CW (to high end of band). DVM should indicate +10.0 ± 0.2 Vdc. If meter does not indicate correct voltage, refer to HORIZ STOP troubleshooting chart, Figure 7-7.
- i. Select AUTO mode on sweep generator.

NOTE

If no other calibration adjustments are to be performed, complete steps

- j and k, and proceed to step n (skip step m). However, if additional calibration adjustments are required, disregard steps j and k and proceed to step m.
- j. Position A3 PCB TEST-NORMAL switch to NORMAL.
 - k. Refasten A3 PCB to chassis and position 560A upright.
 - m. (See NOTE above.) Depress INPUT A lightly so that all three Channel A INPUT switches are released.
 - n. Adjust OFFSET control until trace is positioned on center graticule line.
 - o. Adjust CRT mainframe HORIZ POSITION control to position left end of trace on left graticule edge.
 - p. Adjust CRT mainframe X-Gain potentiometer to position right end of trace on right graticule edge (Figure 5-12). The HORIZ POSITION control and X-Gain potentiometer are interactive; repeat steps o and p until trace is positioned as shown below.

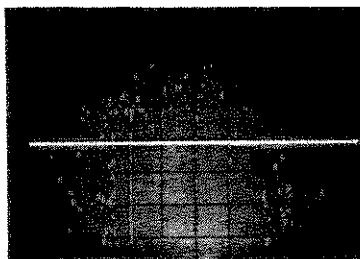

5-3.3 Refresh Horizontal Gain Adjustment (Including X-Y Plot)

This paragraph provides instructions for adjusting the start of the refresh horizontal sweep ramp (R10) and the gains of the refresh sweep ramp in dual-channel sweep (R77), in single-channel sweep (R79) and in single-channel X-Y plot (R81). To perform these adjustments, proceed as follows:

- a. Perform voltage checks per paragraph 5-3.1.

- b. Perform horizontal clamp and CRT mainframe adjustments per paragraph 5-3.2.
- c. Position 560A controls as follows (controls in bold type indicate changes from the previous step):
 CHANNEL A ON: On
INPUT: R
 MEMORY: Off
 dB PER DIVISION: 17 (10, 5, & 2 depressed)
 REFERENCE dB/dBm: dBm
OFFSET dB: +50.0
 OFFSET ZERO: Not depressed
CHANNEL B ON: On
INPUT: R
MEMORY: Off
dB PER DIVISION: 17 (10, 5, & 2 depressed)
REFERENCE dB/dBm: dBm
OFFSET dB: +40.0
 OFFSET ZERO: Not depressed
 MARKER THRESHOLD: Off
REFRESH: On
REFRESH HOLD: Off
 SMOOTHING: Off
A3 PCB TEST-NORMAL: TEST
- d. Adjust both channel OFFSET controls to position traces so that the start (right end) of Channel A refresh ramp (diagonal trace) and the finish (left end) of the Channel B refresh ramp can be observed. See waveform below.

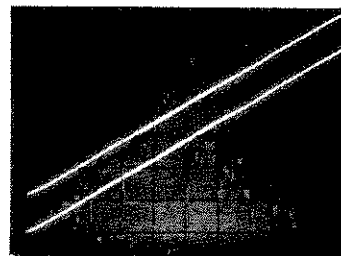

- e. Rotate A2R10 (see Figure 5-14 for location) clockwise until trace flattens on the left side; stop rotation.

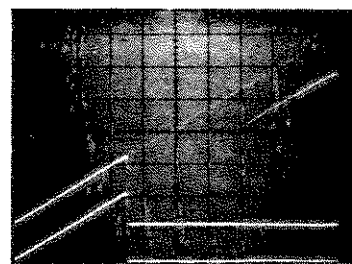

- f. Rotate A2R10 counterclockwise until the trace returns to normal (step d waveform). Continue counterclockwise adjustment for approximately 1/4 turn.
- g. Depress CHANNEL B ON pushbutton (turn Channel B off).
- h. Depress X-Y PLOT pushbutton and observe intensified dot as it moves across CRT. If dot fails to reach left graticule edge, adjust potentiometer A2R81 clockwise; if dot travels beyond left graticule edge, adjust A2R81 counterclockwise. Repeat, as necessary, until dot reaches left graticule edge before disappearing from CRT.
- i. Depress CHANNEL B ON pushbutton.
- j. Adjust A2R77 so that both refresh ramp endpoints coincide with left graticule edge.
- k. Depress CHANNEL B ON pushbutton (turn Channel B off).
- o. Refasten A3 PCB to chassis and position 560A upright.
- p. Adjust CRT mainframe HORIZ POSITION to position left end of trace on left graticule edge.
- q. Adjust CRT mainframe X-Gain potentiometer to position right end of trace on right graticule edge (Figure 5-12). The HORIZ POSITION and X-Gain potentiometers are interactive; repeat steps p and q until trace is positioned as shown below.

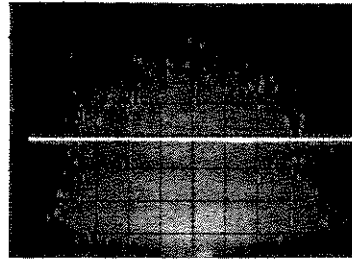

5-3.4 Channel A and Channel B OFFSET ZERO Adjustments

This paragraph provides instructions for adjusting the Channel A and Channel B OFFSET ZERO traces so that their position is coincident with their respective channel's REF POS LOCATE trace position. To perform these adjustments proceed as follows:

- a. Perform voltage checks per paragraph 5-3.1.
- b. Position 560A controls as follows (controls in bold type indicate changes from the previous step):

CHANNEL A ON: **On**
 INPUT: R
 MEMORY: Off
dB PER DIVISION: .2

NOTE

If no other calibration adjustments are to be performed, proceed to step m. If additional calibration adjustments are required, however, disregard steps m thru q and proceed to next calibration adjustment paragraph.

- m. Readjust A2R10 (steps e and f), if necessary.
- n. Adjust A2R79 so that left end of Channel A refresh ramp coincides with left graticule edge.

REFERENCE dB/dBm: dBm
OFFSET: - 00.0
CHANNEL B ON: Off
INPUT: R
MEMORY: Off
dB PER DIVISION: .2
REFERENCE dB/dBm: dBm
OFFSET ZERO: Not depressed
MARKER THRESHOLD: Off
REAL TIME: On
SMOOTHING: Off

- c. Depress INPUT A pushbutton lightly so that all three Channel A INPUT switches are released.
- d. Depress and hold REF POS LOCATE pushbutton and adjust SET screwdriver potentiometer to position trace on center graticule line.
- e. Release REF POS LOCATE.
- f. Depress OFFSET ZERO; adjust A2R195 (see Figure 5-14 for location) to position trace on center graticule line.
- g. Depress REF POS LOCATE momentarily and insure that trace does not deflect. (Note: Increase sweep generator sweep speed for a steady, non-flickering trace.)
- h. Depress (release) OFFSET ZERO.
- i. Depress Channel A INPUT R.
- j. Depress both CHANNEL A ON and CHANNEL B ON pushbuttons (turn Channel A off and Channel B on).
- k. Depress INPUT B pushbutton lightly so that all three Channel B INPUT switches are released.
- m. Depress and hold REF POS LOCATE and adjust SET potentiometer to position trace on center graticule line.
- n. Release REF POS LOCATE.

- o. Depress OFFSET ZERO; adjust potentiometer A2R197 to position trace on center graticule line.
- p. Depress REF POS LOCATE momentarily and insure that trace does not deflect. (Note: Increase sweep speed for steady, non-flickering trace.)
- q. Depress (release) OFFSET ZERO.
- r. Depress Channel B INPUT R.

NOTE

If no other calibration adjustments are to be performed, proceed to step s. If additional calibration adjustments are required, however, disregard step s and proceed to next calibration adjustment paragraph.

- s. Refasten A3 PCB to chassis and position 560A upright.

5-3.5 CRT Mainframe Vertical Calibration

This paragraph provides instructions for adjusting the CRT mainframe vertical deflection circuits to be compatible with the 560A vertical signal. To perform these adjustments, proceed as follows:

- a. Perform voltage checks per paragraph 5-3.1.
- b. Perform Channel A and Channel B OFFSET ZERO adjustments per paragraph 5-3.4
- c. Position 560A controls as follows (controls not indicated may be in any position. Controls in bold type indicate changes from the previous step):

CHANNEL A ON: On
INPUT: R
MEMORY: Off
dB PER DIVISION: 5

REFERENCE dB/dBm: dBm

OFFSET: 30.0

OFFSET ZERO: Not depressed

CHANNEL B ON: Off

MARKER THRESHOLD: Off

REAL TIME: On

SMOOTHING: Off

OUTPUT MODE (rear panel): CRT

- d. Depress INPUT A pushbutton lightly so that all three Channel A INPUT push-buttons are released.
- e. Depress and hold REF POS LOCATE.
- f. Observe CRT and adjust SET screwdriver potentiometer to position trace on next-to-bottom graticule line.
- g. Release REF POS LOCATE.
- h. Observe CRT and adjust CRT mainframe Y-Gain potentiometer (see Figure 5-12 for location) to position trace on next-to-top graticule line. The CRT mainframe Y-Gain and 560A Reference Position SET potentiometers interact to control vertical deflection; repeat steps e thru h until trace is positioned as described.
- i. Connect DVM between rear panel VERTICAL OUTPUT connector center conductor and chassis.
- j. Depress and hold REF POS LOCATE.
- k. Adjust SET potentiometer for 0.000 ± 0.025 Vdc, as indicated on DVM.
- m. Adjust CRT mainframe Y-Position potentiometer to position trace on center graticule line.
- n. Observe CRT and rotate SET potentiometer throughout its entire range. Trace should move smoothly from off-screen top to off-screen bottom. If trace does not deflect as described, refer to Figure 7-5 and troubleshoot the Reference Position SET circuit.
- o. Release REF POS LOCATE.

NOTE

If no other calibration adjustments are to be performed, proceed to step p. If additional calibrations are required, however, disregard steps p and q and proceed to next calibration paragraph.

- p. Depress INPUT R.
- q. Refasten A3 PCB to chassis and position 560A upright.

5-3.6 Storage Memory Digital-to-Analog Converter Calibration

This paragraph provides instructions for calibrating the storage memory digital-to-analog (D/A) converter's gain and offset potentiometers, A2R31 and A2R34, respectively. To perform these adjustments, proceed as follows:

- a. Perform voltage checks per paragraph 5-3.1.
- b. Perform horizontal clamp and CRT mainframe horizontal deflection adjustments per paragraph 5-3.2.
- c. Perform refresh horizontal gain adjustments per paragraph 5-3.3.
- d. Perform Channel A and Channel B OFFSET ZERO adjustments per paragraph 5-3.4.
- e. Perform CRT mainframe vertical calibration per paragraph 5-3.5.
- f. Position 560A controls as follows (controls not indicated may be in any position; controls in bold type indicate changes from previous step):

CHANNEL A ON: On
INPUT: R
MEMORY: Off
dB PER DIVISION: 1

REFERENCE dB/dBm: dBm
OFFSET ZERO: Not depressed
OFFSET: +50.0

MARKER THRESHOLD: Off
REAL TIME: On
SMOOTHING: Off

A3 PCB TEST-NORMAL: TEST

- g. Depress and hold REF POS LOCATE and adjust SET screwdriver potentiometer to position trace on center graticule line.
- h. Release REF POS LOCATE.
- i. Observe CRT. A diagonal trace with a steep slope should be present; see waveform below.

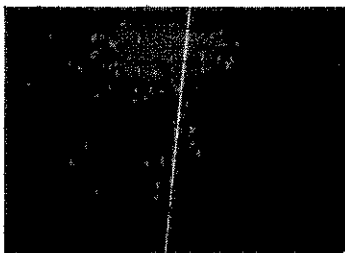

- j. Depress STORE TRACE momentarily.
- k. Depress RECALL. A digitized trace similar to that observed in step i should be present on CRT. See waveform below.

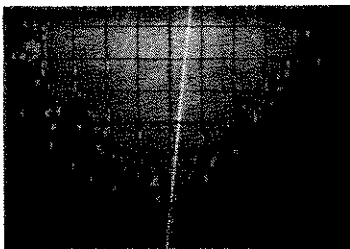

- m. Depress 2 dB PER DIVISION pushbutton.
- n. Observe CRT; a digitized trace that resembles a backwards Z (see waveform below) should be present.

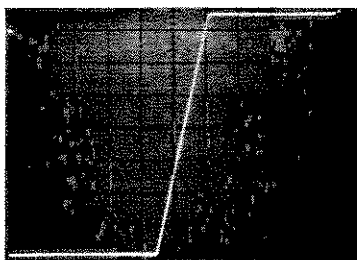

- o. Adjust A2R31 and A2R34 (see Figure 5-14 for locations) so that horizontal elements of the Z-shaped trace are slightly above and below the top and bottom solid graticule lines; see waveform below. (Note: A2R31 adjusts the overall height of the Z, and A2R34 adjusts its vertical offset.)

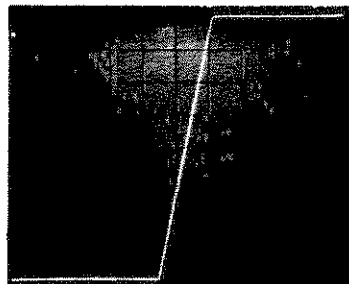

NOTE

If no other calibration adjustments are to be performed, proceed to step p. If additional calibration adjustments are required, however, disregard steps p thru u and proceed to next calibration adjustment paragraph.

- p. Depress MEMORY OFF.
- q. Position A3 PCB TEST-NORMAL switch to NORMAL.
- r. Refasten A3 PCB to chassis and position 560A upright.
- s. Adjust OFFSET control until trace is positioned on center graticule line.
- t. Adjust CRT mainframe HORIZ POSITION control to position left end of trace on left graticule edge.
- u. Adjust CRT mainframe X-Gain potentiometer to position right end of trace on right graticule edge. The HORIZ POSITION control and X-Gain potentiometer are interactive; repeat steps t and u until trace is positioned as shown below.

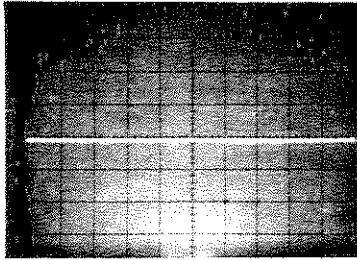

5-3.7 Vertical Analog-to-Digital Converter Calibration

This paragraph provides instructions for calibrating the vertical analog-to-digital (A/D) converter's gain and offset potentiometers, A2R19 and A2R24 respectively. To perform these adjustments, proceed as follows:

- a. Perform voltage checks per paragraph 5-3.1.
- b. Perform horizontal clamp and CRT mainframe horizontal deflection adjustments per paragraph 5-3.2.
- c. Perform refresh horizontal gain adjustments per paragraph 5-3.3.
- d. Perform Channel A and Channel B OFFSET ZERO adjustments per paragraph 5-3.4.
- e. Perform CRT mainframe vertical calibration per paragraph 5-3.5.
- f. Perform storage memory digital-to-analog converter calibration per paragraph 5-3.6.
- g. Position 560A controls as follows (controls in bold type indicate changes from previous step):

CHANNEL A ON: On
 INPUT: R
 REFERENCE dB/dBm: dBm
 OFFSET: +50.0
 OFFSET ZERO: Not depressed
 CHANNEL B ON: Off
 INPUT: R
dB PER DIVISION: 10

REFERENCE dB/dBm: dBm
 OFFSET ZERO: Not depressed
 MARKER THRESHOLD: Off
REFRESH: On
REFRESH HOLD: Off
 SMOOTHING: Off

A3 PCB TEST-NORMAL: TEST

- h. Depress and hold REF POS LOCATE and adjust SET screwdriver potentiometer to position trace on center graticule line.
- i. Release REF POS LOCATE.

NOTE

Steps j thru o, below, provide a means of observing the output of the vertical A/D converter. The analog input signal is digitized, memo- rized, recalled and subtracted from a signal of equal value. The subtracted signal is then amplified at .2 dB per divi- sion and displayed on the CRT. When the vertical A/D con- verter gain and offset potenti- ometers are properly adjusted, the subtracted signal is a straight line ± 0.6 dB.

- j. Depress MEMORY OFF.
- k. Depress 10 dB PER DIVISION pushbutton.
- m. Depress STORE TRACE momentarily.
- n. Depress SUBTRACT.
- o. Depress .2 dB PER DIVISION pushbutton.
- p. Observe CRT. A sloping trace similar to either A or B below should appear.

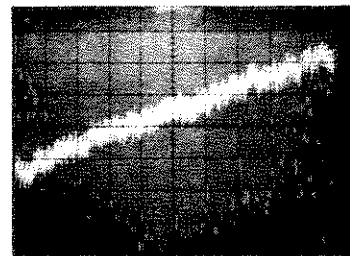

A

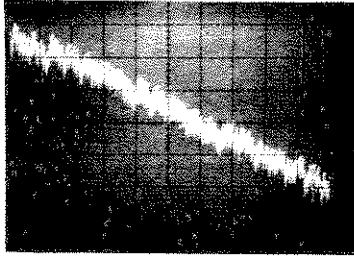

B

NOTE

Trace may be off screen. Increase dB PER DIVISION switch settings to either 1, 2, or 5 to bring trace back on screen.

NOTE

In steps q thru y, below, adjustments made to A2R24 (offset) and A2R19 (gain) will have only minimal effects on the trace presently being displayed. Reason: The displayed trace is created, in part, by the storage memory and these two potentiometers affect the signal before it is memorized. The potentiometer's effect will be seen when the A/D converter output is next recalled from memory and displayed, which occurs each time steps j thru o are performed.

- q. If trace observed on CRT is below center graticule line, rotate A2R24 (see Figure 5-14 for location) slightly clockwise. If trace is above center graticule line, rotate A2R24 slightly counterclockwise.
- r. Repeat steps j thru o, above.
- s. Observe CRT with .2 dB PER DIVISION pushbutton depressed. If right trace end is not superimposed on right side of center graticule line, repeat steps j thru q. If right end of trace is positioned as described (see below), proceed with step t.

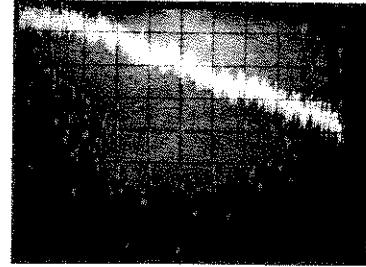

A

- t. Observe CRT. If trace has a right-to-left downward (negative) slope (waveform A below), adjust potentiometer A2R19 slightly clockwise. Conversely, if trace has a right-to-left upward (positive) slope (waveform B below), adjust A2R19 slightly counterclockwise.

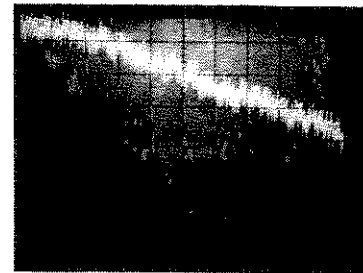
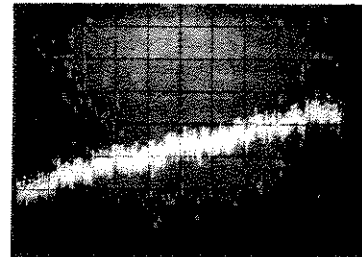

B

- u. Repeat steps j thru o, above.
- v. Observe CRT. If trace still has a slope, repeat steps j thru o and t, above, until trace is level at .2 dB per division of trace deflection. Now, if trace is level and superimposed on center graticule line, as shown below, proceed to step z. However, if trace is level but not centered, proceed to step w.

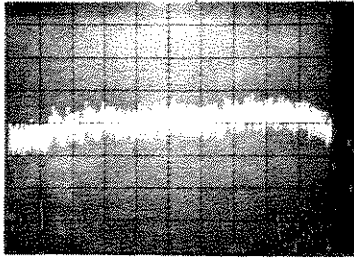

w. Observe CRT. If level trace is above center graticule line, rotate A2R24 slightly clockwise. Conversely, if level trace is below center graticule line, rotate A2R24 slightly counterclockwise.

x. Repeat steps j thru o, above.

y. Observe CRT. If trace is level and superimposed on center graticule line, proceed to step z. If trace is not centered, repeat steps w thru y until trace is centered.

NOTE

The purpose of steps z thru ah is to balance A2R19 so that the vertical A/D converter has equal gain (slope) for Channel A and Channel B signals.

z. Depress MEMORY OFF.

aa. Depress 10 dB PER DIVISION push-button.

ab. Depress CHANNEL B ON pushbutton (turn Channel B on).

ac. Depress and hold Channel B REF POS LOCATE and adjust SET potentiometer to center Channel B trace on center graticule line.

ad. Adjust Channel B OFFSET control to superimpose Channel B trace over Channel A trace.

ae. Repeat steps j thru o, above, for both channels.

af. Observe CRT. If the left-to-right excursion of the Channel B trace slopes more

than ± 3 major divisions from the center graticule line (see waveform below), re-adjust A2R19 either slightly clockwise or slightly counterclockwise. The direction of A2R19 rotation depends on whether the trace-slope is positive or negative, as described in step t.

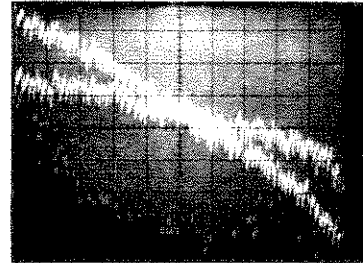

ag. Repeat steps j thru o, above, for both channels.

ah. Observe CRT. The ends of the Channel A and Channel B traces, in the criss-cross waveform pattern (see below), should be contained within the 6 major divisions that extend ± 3 divisions on either side of the center graticule line. If the distance between the trace ends is, as described, the adjustment is complete. If, however, the distance between the trace ends is not correct, repeat steps j thru o, af, and ag, above, until trace end distance is within the ± 3 division tolerance.

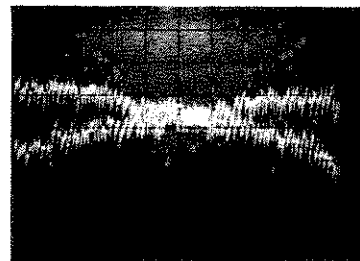

NOTE

If no other calibration adjustments are to be performed, proceed to step ai. If additional calibration adjustments are required, however, disregard steps ai thru ap and proceed to next calibration adjustment paragraph.

- ai. Depress CHANNEL B ON pushbutton (turn Channel B off).
- aj. Depress Channel A and Channel B MEMORY OFF.
- ak. Position A3 PCB TEST-NORMAL switch to NORMAL.
- am. Refasten A3 PCB to chassis and position 560A upright.
- an. Adjust OFFSET control until trace is positioned to center graticule line.
- ao. Adjust CRT mainframe HORIZ POSITION to position left end of trace on left graticule edge.
- ap. Adjust CRT mainframe X-Gain potentiometer to position right end of trace on right graticule edge. The HORIZ POSITION control and X-Gain potentiometer are interactive; repeat steps ao and ap until trace is positioned as shown below.

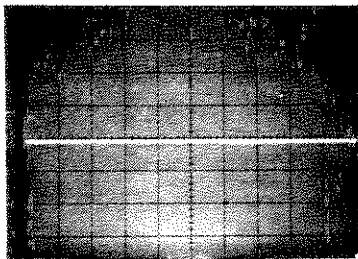

5-3.8 Channel A and Channel B Memory and Subtract Balance Adjustments

This paragraph provides instructions for adjusting the Channel A and Channel B storage memory and memory-subtract balance potentiometers. The storage memory potentiometers, A2R138 and A2R133, are located on the digital (A2) PCB. The memory-subtract balance potentiometers, A1R84 and A1R86, are located on the front panel (A1) PCB. To perform these adjustments, proceed as follows:

- a. Perform voltage checks per paragraph 5-3.1.

- b. Perform horizontal clamp and CRT mainframe horizontal deflection adjustments per paragraph 5-3.2.
- c. Perform refresh horizontal gain adjustments per paragraph 5-3.3.
- d. Perform Channel A and Channel B OFFSET ZERO adjustments per paragraph 5-3.4.
- e. Perform CRT mainframe vertical calibration per paragraph 5-3.5.
- f. Perform storage memory digital-to-analog converter calibration per paragraph 5-3.6.
- g. Perform vertical analog-to-digital converter calibration per paragraph 5-3.7.
- h. Position 560A controls as follows (controls in bold type indicate changes from previous step):

CHANNEL A ON: On
 INPUT: R
MEMORY: Off
 dB PER DIVISION: 2
 REFERENCE dB/dBm: dBm
 OFFSET ZERO: Not depressed
CHANNEL B ON: Off
 INPUT: R
MEMORY: Off
 dB PER DIVISION: 2
 REFERENCE dB/dBm: dBm
 OFFSET ZERO: Not depressed
 THRESHOLD: Off
REAL TIME: On
 SMOOTHING: Off
A3 PCB TEST-NORMAL: TEST

- i. Depress INPUT A pushbutton lightly so that all three Channel A INPUT switches are released.
- j. Depress and hold REF POS LOCATE and adjust SET screwdriver potentiometer to position trace on center graticule line.
- k. Release REF POS LOCATE.
- m. Depress OFFSET ZERO.
- n. Depress STORE TRACE momentarily.

- o. Depress RECALL.
- p. Observe CRT and adjust A2R138 (see Figure 5-14 for location) to position trace on the center graticule line.
- q. Depress SUBTRACT.

CAUTION

In step r, A1R84 is difficult to reach, particularly on the horizontal chassis. To reach the potentiometer, place the A3 PCB in the horizontal (closed) position. To perform the adjustment, use an insulated adjustment tool; exercise caution to avoid slipping off the potentiometer and causing damage to the A1 PCB.

- r. Observe CRT and adjust A1R84 (see Figure 5-13 for location) to position trace on center graticule line.
- s. Depress RECALL and SUBTRACT alternately; there should be no change in trace position. If change is observed, repeat steps p thru s until trace position shows no change.
- t. Depress (release) OFFSET ZERO.
- u. Depress Channel A INPUT R.
- v. Depress CHANNEL B ON and CHANNEL A ON pushbuttons (turn Channel B on and Channel A off).
- w. Depress INPUT B pushbutton lightly so that all three Channel B INPUT switches are released.
- x. Depress and hold REF POS LOCATE and adjust SET screwdriver potentiometer to position trace on center graticule line.
- y. Release REF POS LOCATE.
- z. Depress OFFSET ZERO.

- aa. Depress STORE TRACE momentarily.
- ab. Depress RECALL.
- ac. Observe CRT and adjust A2R133 to position trace on center graticule line.
- ad. Depress SUBTRACT.

CAUTION

In step ae, A1R86 is difficult to reach, particularly on the horizontal chassis. To reach the potentiometer, place the A3 PCB in the horizontal (closed) position. To perform the adjustment, use an insulated adjustment tool; exercise caution to avoid slipping off the potentiometer and causing damage to the A1 PCB.

- ae. Observe CRT and adjust A1R86 to position trace on center graticule line.
- af. Depress RECALL and SUBTRACT alternately; there should be no change in trace position. If change is observed, repeat steps ac thru af until trace position shows no change.
- ag. Depress (release) OFFSET ZERO.
- ah. Depress Channel B INPUT R.
- ai. Depress Channel A and Channel B MEMORY OFF pushbuttons.

NOTE

The purpose of the following steps is to recheck the vertical A/D converter's gain and offset.

- aj. Depress CHANNEL A ON pushbutton (turn Channel A on).
- ak. Depress Channel A and Channel B 10 dB PER DIVISION pushbuttons.
- am. Depress REFRESH.

- an. Readjust Channel B OFFSET to superimpose Channel B trace on Channel A trace.
- ao. Depress Channel A and Channel B STORE TRACE; then SUBTRACT.
- ap. Depress Channel A and Channel B .2 dB PER DIVISION pushbuttons.
- aq. Observe CRT. The ends of the Channel A and Channel B traces, in the criss-cross waveform pattern (see below), should be contained within the 6 major divisions that extend ± 3 divisions on either side of the center graticule line. If the criss-cross waveform pattern is positioned as described, proceed to step ar. If, however, the criss-cross pattern is offset from the center graticule line, readjust A2R24 as described in step w of paragraph 5-3.7.
- au. Refasten A3 PCB to chassis and position 560A upright.
- av. Adjust OFFSET control until trace is positioned to center graticule line.
- aw. Adjust CRT mainframe HORIZ POSITION to position left end of trace on left graticule edge.
- ax. Adjust CRT mainframe X-Gain potentiometer to position right end of trace on right graticule edge. The HORIZ POSITION control and X-Gain potentiometer are interactive; repeat steps aw and ax until trace is positioned as shown below.

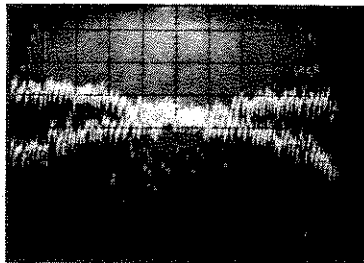

NOTE

If no other calibration adjustments are to be performed, proceed to step ar. If additional calibration adjustments are required, however, disregard steps ar thru ax and proceed to next calibration adjustment paragraph.

- ar. Depress Channel B INPUT R.
- as. Depress Channel A and Channel B MEMORY OFF.
- at. Position A3 PCB TEST-NORMAL switch to NORMAL.

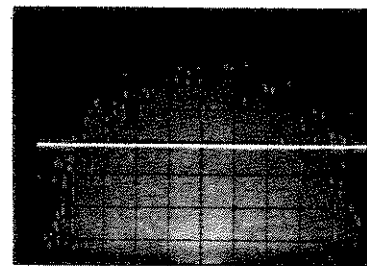

5-3.9 Refresh Digital-to-Analog Converter Calibration and Dot Connector Adjustments

This paragraph provides instructions for calibrating the refresh memory's offset and gain potentiometers, A2R43 and A2R40 respectively, and adjusting the dot connector potentiometers A2R46 and A2R50. To perform these adjustments, proceed as follows.

- a. Perform voltage checks per paragraph 5-3.1.
- b. Perform horizontal clamp and CRT mainframe horizontal deflection adjustments per paragraph 5-3.2.
- c. Perform refresh horizontal gain adjustments per paragraph 5-3.3.
- d. Perform Channel A and Channel B OFFSET ZERO adjustments per paragraph 5-3.4.
- e. Perform CRT mainframe vertical calibration per paragraph 5-3.5.

- f. Perform storage memory digital-to-analog converter calibration per paragraph 5-3.6.
- g. Perform vertical analog-to-digital converter calibration per paragraph 5-3.7.
- h. Perform Channel A and Channel B memory and subtract balance adjustments per paragraph 5-3.8.
- i. Position 560A controls as follows (controls not indicated may be in any position; those in bold type are changes from the previous step):

CHANNEL A ON: On
 INPUT: R
MEMORY: Off
dB PER DIVISION: 5
 REFERENCE dB/dBm: dBm
 OFFSET: -30.0
 OFFSET ZERO: Not depressed

CHANNEL B ON: Off
MEMORY: Off
 MARKER THRESHOLD: Off
REAL TIME: On
 SMOOTHING: Off
A3 PCB TEST-NORMAL: TEST

- j. Depress INPUT A pushbutton lightly so that all three Channel A INPUT switches are released.
- k. Depress and hold REF POS LOCATE.
- m. Observe CRT and adjust SET screwdriver potentiometer to position trace on next-to-bottom graticule line.
- n. Release REF POS LOCATE.
- o. Observe CRT and adjust OFFSET control to position trace on next-to-top graticule line.
- p. Depress OFFSET ZERO and insure that trace deflects to next-to-bottom graticule line. Depress (release) OFFSET ZERO. If trace is not coincident with the REF POS LOCATE reference trace (next-to-bottom graticule line), refer to paragraph 5-3.4 and repeat the OFFSET

ZERO adjustments.

- q. Depress REFRESH; insure REFRESH HOLD is not depressed.
- r. Depress OFFSET ZERO.
- s. Observe CRT and adjust potentiometer A2R43 (see Figure 5-14 for location) to position trace on next-to-bottom graticule line. See waveform below.

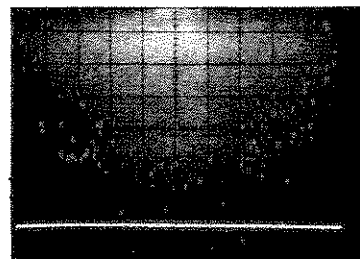

- t. Depress (release) OFFSET ZERO.
- u. Observe CRT and adjust potentiometer A2R40 to position trace on next-to-top graticule line. See waveform below.

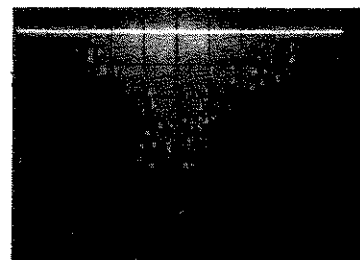

- v. Depress REAL TIME.
- w. Depress and hold REF POS LOCATE.
- x. Observe CRT and adjust SET potentiometer to position trace to next-to-top graticule line.
- y. Release REF POS LOCATE.
- z. Observe CRT and adjust OFFSET control to position trace on next-to-bottom graticule line (≈ -30.0).
- aa. Depress OFFSET ZERO and insure that trace deflects to next-to-top graticule line. Depress (release) OFFSET ZERO.
- ab. Depress REFRESH.

- ac. Depress OFFSET ZERO and insure that trace deflects to next-to-top graticule line ± 1 minor division. If trace deflection is not as described, A2 PCB is faulty.
- ad. Depress REAL TIME.
- ae. Set controls for a 10 s sweep.
- af. Observe CRT and when intensified dot reaches the right side of the screen, depress REFRESH.
- ag. Depress OFFSET ZERO; when refresh sweep starts, alternately release and depress OFFSET ZERO to obtain approximately 10 to 12 rectangular pulses on the CRT. At the conclusion of the refresh sweep, immediately depress REFRESH HOLD to save the display.
- ah. Adjust A2R46 to obtain optimum pulse response--no overshoot or ringing; see waveform below.

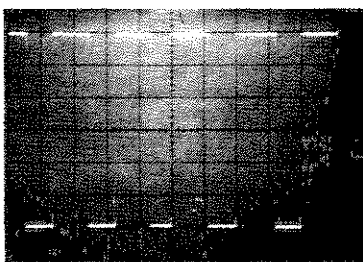

- ai. Depress X-Y PLOT and adjust A2R50 to obtain optimum pulse response--no overshoot or ringing.
- aj. Depress (release) REFRESH HOLD.
- ak. Set controls for 100 ms sweep.
- am. Depress REAL TIME.
- an. Position A3 PCB TEST-NORMAL switch to NORMAL.
- ao. Refasten A3 PCB to chassis and position 560A upright.

- ap. Adjust OFFSET control until trace is positioned to center graticule line.
- aq. Adjust CRT mainframe X-position potentiometer (see Figure 5-12 for location) to position left end of trace on left graticule edge.
- ar. Adjust CRT mainframe X-Gain potentiometer to position right end of trace on right graticule edge. The HORIZ POSITION control and the X-Gain potentiometer are interactive; repeat steps aq and ar until trace is positioned as shown below.

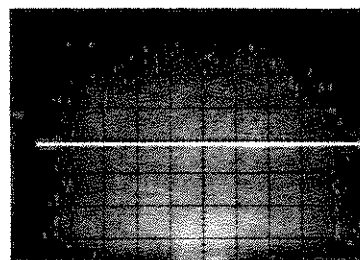

5-4 LOG AMPLIFIER (A3) PCB ADJUSTMENTS

The adjustments required to calibrate the log amplifier PCB circuits are described in the following paragraphs. These adjustments should only be performed by qualified personnel, and only when the performance verification tests of Section IV indicate an out-of-tolerance condition exists. The log amplifier accuracy adjustments in paragraph 5-4.3 are particularly critical and should not be attempted unless it is reasonably certain that log amplifier accuracy specifications are not being met (refer to paragraph 4-4.1 and Table 4-3). If the performance tests in Section IV indicate that the log amplifier is within the range of tolerances specified in Table 1-1, do not adjust log amplifier potentiometers.

5-4.1 Channels A, B, A&B, and R Power Supply, Offset, Reference, and Thermistor Voltage Checks and Adjustments

This paragraph provides instructions for checking and/or adjusting the Channel A,

B, A&B, and R power supply, offset, reference, and thermistor voltages. To check and adjust these voltages does not require that a sweep generator be connected to the 560A. However, the sweep generator may be left connected if desired; it will not affect voltage readings. To check and adjust the offset, reference, and thermistor voltages requires the use of a simulated detector. This simulated detector contains precision resistors for simulating the detector diode, offset potentiometer, and thermistor resistances. Figure 5-5 shows

this simulated detector and provides both fabrication instructions and a parts list. To perform the checks and adjustments in this paragraph, gain access to the A3 PCB (paragraph 5-2) and proceed as follows:

- a. Depress 560A POWER to ON. Other controls may be in any position.
- b. Perform Channel A, Channel B, Channel A&B, and Channel R power supply checks as follows:

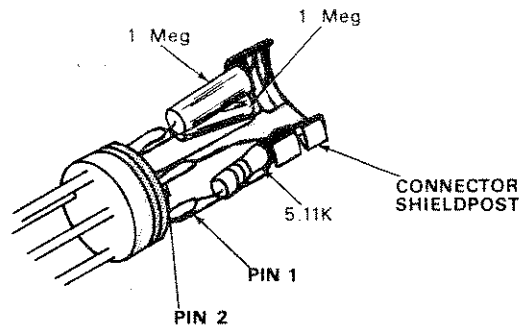

Fabricate simulated detector as follows:

1. Solder one end of 5.11 k Ω resistor to pin 1. Solder the other resistor lead to the connector shieldpost and to pin 2.
2. Solder 1 M Ω resistor to pin 3. Solder the other resistor lead to shieldpost.
3. Solder 1 M Ω resistor to pin 4. Solder the other resistor lead to shieldpost.

Simulated Detector Parts List

Part Description	Part Number	Vendor
Connector, Plug	09CL4M	Switchcraft, Inc.
Resistor, Metal Film, 5.11 k Ω , 1/8W, 1% (1 each)	EMF55T1-5.11k-1%	Dale Elect.
Resistor, Metal Film, 1 M Ω , 1/8W, 0.1% (2 each)	EMF55T9-1 Meg-0.1% RNC55J1DO4BS	Dale Elect. Mil. Spec.

Figure 5-5. Simulated Detector Fabrication Instructions and Parts List

1. Connect DVM test leads between TP19 and TP20 (see Figure 5-10 for location). Meter should indicate $30.0 \pm 1.2\text{Vdc}$.
 2. Connect DVM test leads between TP21 and TP22. Meter should indicate $30.0 \pm 1.2\text{Vdc}$.
 3. Connect DVM test leads between TP1 and TP4 (common). Meter should indicate $+15.0 \pm 0.6\text{Vdc}$.
 4. Connect DVM test leads between TP2 and TP4 (common). Meter should indicate $-15.0 \pm 0.6\text{Vdc}$.
 5. Connect DVM test leads between TP9 and TP12 (common). Meter should indicate $+15.0 \pm 0.6\text{Vdc}$.
 6. Connect DVM test leads between TP10 and TP12 (common). Meter should indicate $-15.0 \pm 0.6\text{Vdc}$.
- c. Connect simulated detector to front panel A connector.
- d. Depress CHANNEL A ON pushbutton (turn Channel A on). Insure that CHANNEL B ON pushbutton is not depressed (Channel B off).
- e. Perform Channel A&B zero tracking, and Channel A offset and thermistor checks and/or adjustments as follows:
1. Connect DVM test leads between TP3 and TP4 (common). Adjust potentiometer A3R68 for 0 volts $\pm 50\mu\text{V}$.
 2. Connect DVM test leads between TP16 and TP4 (common). Adjust potentiometer A3R18 for 0 volts $\pm 20\text{mV}$.
 3. Connect DVM test leads between TP15 and TP4 (common). Meter should indicate 0 ± 0.1 volts.
- f. Connect simulated detector to front panel B connector.
- g. Depress CHANNEL A ON and CHANNEL B ON pushbuttons. (Turn Channel A off and Channel B on.)
- h. Perform Channel B offset, thermistor, and reference voltage checks and adjustments as follows:
1. Connect DVM test leads between TP16 and TP4 (common). Adjust potentiometer A3R27 for 0 volts $\pm 20\text{mV}$.
 2. Connect DVM test leads between TP15 and TP4 (common). Meter should indicate $0 \pm 0.1\text{Vdc}$.
 3. Connect DVM test leads between TP5 and TP6. Adjust potentiometer A3R182 for 8.25 volts $\pm 3.0\text{mV}$.
- i. Connect simulated detector to front panel R connector.
- j. Perform Channel R zero tracking, offset, thermistor, LOG 1 R, LOG 2 R, and reference voltage checks and/or adjustments as follows:
1. Connect DVM test leads between TP11 and TP12 (common). Adjust potentiometer A3R209 for 0 volts $\pm 50\mu\text{V}$.
 2. Connect DVM test leads between TP18 and TP12 (common). Adjust potentiometer A3R255 for 0 volts $\pm 20\text{mV}$.
 3. Connect DVM test leads between TP17 and TP12 (common). Meter should indicate $0 \pm 0.1\text{V}$.
 4. Connect DVM test leads between TP7 and TP12 (common). Adjust potentiometer A3R190 for 0 volts $\pm 100\mu\text{V}$.
 5. Connect DVM test leads between TP8 and TP12 (common). Adjust potentiometer A3R194 for 0 volts $\pm 3.0\text{mV}$.
 6. Connect DVM test leads between TP13 and TP14. Adjust potentiometer A3R284 for 8.25 volts $\pm 3.0\text{mV}$.

5-4.2 Channels A&B Detector Balance Adjustment

This paragraph provides instructions for adjusting Detector A Balance and Detector B Balance potentiometers R315 and R312 respectively. For these adjustments, the 560A must be interconnected with the sweeper as shown in Figure 5-4. To perform these adjustments, proceed as follows:

- a. Perform the voltage checks and adjustments in paragraph 3-4.1.
- b. Reinstall bottom cover and place 560A in upright position (normal operating configuration). Allow 30 minutes for temperature stabilization.

NOTE

To allow for normal airflow across the affected components, the 560A must be upright with all covers in place.

- c. Position 560A controls as follows:

CHANNEL A ON: On
INPUT: A
MEMORY: Off
dB PER DIVISION: 10
REFERENCE dB/dBm: dBm
OFFSET ZERO: Not depressed
CHANNEL B ON: Off
INPUT: B
MEMORY: Off
dB PER DIVISION: 10
REFERENCE dB/dBm: dBm
OFFSET ZERO: Not depressed
MARKER THRESHOLD: Off
REFRESH: On
REFRESH HOLD: Off
SMOOTHING: OFF
POWER: On

- d. Disconnect simulated detector from front panel R connector; leave front panel connectors A and B disconnected.
- e. Position CHA A and CH B LOW LEVEL TRIM potentiometers (right side panel) to midrange.
- f. Turn 560A upside down and slide bottom cover back.
- g. Adjust OFFSET Channel A control to place the trace in the center of the display (≈ -35 dBm).
- h. Adjust R315 for waveform similar to the one shown below.
- i. Depress CHANNEL A ON (release) and depress CHANNEL B ON.
- j. Adjust OFFSET Channel B control to place the trace in the center of the display (≈ -35 dBm).
- k. Adjust R312 for waveform similar to the one shown below.

NOTE

Perform these adjustments as rapidly as possible, while the 560A's internal temperature is still stable.

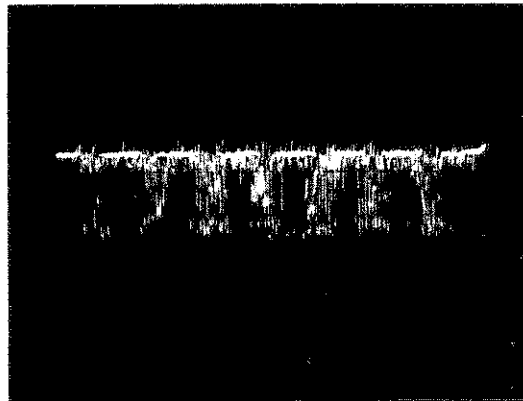

5-4.3 Channels A&B and R Log Amplifier Accuracy Adjustments

This paragraph provides instructions for checking and adjusting the Channel A&B and Channel R log amplifier accuracy. There are two accuracy adjustments for each log amplifier channel (A&B and R); one adjusts the log amplifier channel to provide 125mV per dBm of input signal, and the other adjusts the log amplifier output so that 0 volts equals 0 dBm. Both of these adjustments are critical and should not be adjusted unless it is reasonably certain, based on the criteria in paragraph 4-4, that the log amplifier accuracy specifications are not being met. As explained in the NOTE preceding step j in paragraph 4-3, log amplifier accuracy testing is divided into two tests--one test for +10 to -50 dBm and a second test, if necessary, for +16 dBm. Figure 5-6 shows the test setup and provides initial sweep generator control positioning for the +10 to -50 dBm test.

To perform log amplifier accuracy tests and adjustments, gain access to the A3 PCB (paragraph 5-2); then proceed as follows:

- a. Calibrate the power meter and power sensor as follows:
 1. Position CAL FACTOR control on power meter to specified calibrate factor, as indicated by chart on power sensor.
 2. Position Range control on power meter to 1mW.
 3. Connect power sensor to POWER REF connector; adjust CAL ADJ screw-driver potentiometer to position meter pointer on CAL mark.
 4. Disconnect power sensor from POWER REF connector.
- b. Calibrate the sweep generator/step attenuator power output for 0 dBm, as indicated on power meter. Proceed as follows:

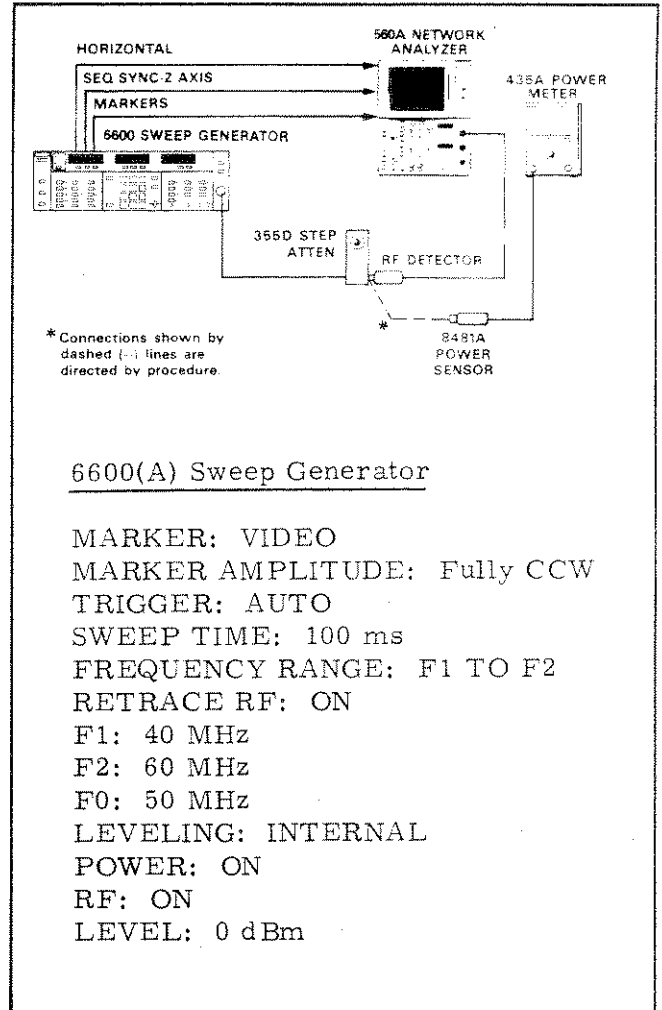

Figure 5-6. Test Setup for Power Accuracy Tests

1. Set FREQUENCY RANGE to CW F0 (6647(A)).
2. Set controls for +10 dBm output.
3. Position attenuation dial on 355D to 10.
4. Connect power sensor to 355D output (dashed line connection shown in Figure 5-6).
5. Set controls for 0 dBm output.

6. Set FREQUENCY RANGE to F1 TO F2 (6647).

7. Disconnect power sensor from 355D.

c. Position 560A controls as follows:

CHANNEL A ON: On
INPUT: A
MEMORY: Off
dB PER DIVISION: 1
REFERENCE dB/dBm: dBm
OFFSET ZERO: Not depressed

CHANNEL B ON: Off
INPUT: B
MEMORY: Off
dB PER DIVISION: 1
REFERENCE dB/dBm: dBm
OFFSET ZERO: Not depressed
MARKER THRESHOLD: Off
REFRESH: On
REFRESH HOLD: Off
SMOOTHING: MAX
POWER: On

d. Perform Channel A low level calibration. In this and all subsequent steps, the directions to rotate controls clockwise and counterclockwise and to observe CRT trace for up or down movement assume that 560A is positioned upside down.

1. Connect RF detector to front panel A connector. (Leave detector unconnected from RF source.)
2. Depress and hold REF POS LOCATE and adjust SET potentiometer to position trace on center graticule line.
3. Release REF POS LOCATE.
4. Adjust OFFSET control for -58.0, as indicated on OFFSET dB display.
5. Adjust CH A LOW LEVEL TRIM control (right side panel) as follows:

(a) If trace is above center graticule line, rotate potentiometer clockwise until trace is slightly below

center graticule line and exhibits only random positive clipping. See waveform below.

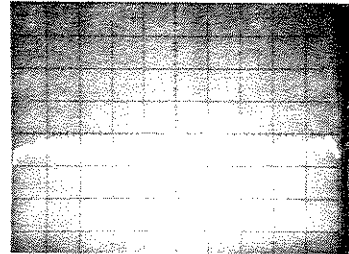

(b) If trace is either below center graticule line or off-screen, rotate potentiometer counterclockwise until trace is positioned as described in step (a), above.

e. Perform Channel A power accuracy test as follows:

1. Rotate OFFSET control clockwise to +10.0, as indicated on OFFSET dB display.
2. Connect RF detector to 355D output connector.
3. Depress .2 dB PER DIVISION push-button.

4. Construct a chart similar to that shown in Table 5-1.

5. Operate the chart of Table 5-1 as follows:

(a) Position 355D to first Attenuator Dial Setting.

(b) Adjust OFFSET control for first OFFSET dB Reading.

(c) Read accuracy error at 50 MHz (center of trace) directly from CRT. If the trace is below the center graticule line, the accuracy error is + (positive); conversely, if the trace is above the center graticule line, the error is - (negative).

Table 5-1. Channel A Power Accuracy Chart

Attenuator Dial Setting	OFFSET dB Reading	Accuracy Error	* Tolerance (dB)
0	+10.0		+0.6 -0.5
10	- 0.0		+0.6 -0.5
20	-10.0		+0.6 -0.5
30	-20.0		+0.7 -0.6
40	-30.0		±0.7
50	-40.0		±0.8
60	-50.0		±0.9

* Tolerance arrived at through a statistical probability formula--refer to paragraph 4-4.1.

- (d) Record the accuracy error in the "Accuracy Error" column of the chart.
- (e) Repeat steps (a) thru (d) for Attenuator Dial Settings of 10 thru 50.

NOTE

The following steps recheck low level calibration. The LOW LEVEL TRIM potentiometers compensate for thermocouple junction voltage drops between the RF detector and the A3 PCB input circuits. With the bottom cover removed, thermocouple voltage drops between the A connector and the Channel A input circuit may have changed.

- (f) Rotate OFFSET counterclockwise for -58.0, as indicated on the OFFSET dB display.

- (g) Disconnect RF detector from 355D.

- (h) Readjust CH A LOW LEVEL TRIM potentiometer if necessary so that trace is slightly below center graticule line and exhibits only random positive clipping.

- (i) Rotate OFFSET control clockwise for -50.0, as indicated on OFFSET dB display.

- (j) Reconnect RF detector to 355D.

- (k) Position 355D attenuator dial to 60.

- (m) Read and record accuracy error, as described in steps (c) and (d) above.

- f. Perform Channel B low level calibration as follows:

1. Depress CHANNEL A ON and CHANNEL B ON pushbuttons (turn Channel A off and Channel B on).

2. Repeat subparagraph d, steps 1 thru 5 for Channel B.
- g. Perform Channel B power accuracy test by repeating for Channel B the instructions contained in subparagraph e, steps 1 thru 5.
- h. Reconfigure and calibrate the test setup for +16 dBm log amplifier accuracy test as shown below. If testing at +16 dBm is unnecessary (see NOTE preceding step j, paragraph 4-3), skip this step and the one that follows; proceed to step j.

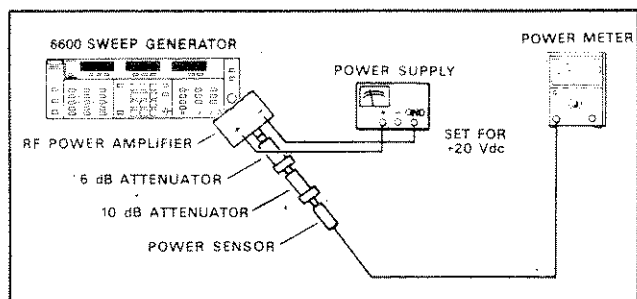

1. Set FREQUENCY RANGE to CW F0 (6647(A)).
2. Set controls for +6 dBm output.
3. Set controls for 0 dBm output.
4. Disconnect power sensor from 10 dB attenuator.
5. Remove both attenuators from test setup and connect RF detector to output of power amplifier.
6. Set FREQUENCY RANGE to F1 TO F2 (6647(A)).
- i. Perform +16 dBm log amplifier accuracy test for Channel A, then Channel B, as follows:
 1. Depress CHANNEL A ON and CHANNEL B ON pushbuttons (turn Channel A on and Channel B off).
 2. Move RF detector to front panel connector A.

3. Rotate OFFSET control counterclockwise to +16.0, as indicated on OFFSET dB display.
4. Read and record the accuracy error at 50 MHz (center of trace) directly from CRT. If trace is below the center graticule line, the accuracy error is + (positive); conversely, if the trace is above the center graticule line, the error is - (negative).
5. Depress CHANNEL A ON and CHANNEL B ON pushbuttons (turn Channel A off and Channel B on).
6. Move RF detector to front panel connector B.
7. Repeat step 4 above for Channel B.
- j. If any of the Channel A or Channel B log amplifier accuracy readings are clearly out of tolerance (refer to paragraph 4-4), see below.

1. The accuracy error in both channels at each Attenuator Dial Setting (Power Accuracy Charts, subparagraphs e4 and g4 above), and at ± 16 dBm (subparagraph i above) should be within ± 0.4 dBm of each other.
 - (a) If the variation is greater than ± 0.4 dBm, the out-of-tolerance condition is not caused by the common A&B log shaper circuit so the accuracy potentiometers (R154 and R181) will not correct the problem; the out-of-tolerance condition is caused by a defect or a maladjustment in the applicable channel's input circuit. (Applicable channel refers to the channel in which the out-of-tolerance condition occurs.) Repeat the adjustment instructions in paragraphs 5-4. 1; if the out-of-tolerance condition still exists, troubleshoot the applicable channel's input circuit.

- (b) If the variation is within ± 0.4 dBm, but the reading(s) is out of tolerance, try a different RF detector and take the measurement again. If the reading(s) is still out of tolerance, proceed to step 2.
2. Construct a graph similar to that shown in Figure 5-7. When the accuracy error reading at each Attenuator Dial Setting (Table 5-1) and at +16 dBm is plotted onto the graph, the graph will show the overall shape of the log amplifier response curve. The two accuracy potentiometers, R181 and R154, do not adjust individual response points; they adjust the overall shape of the response curve. Potentiometer R181 (offset) moves the curve up or down and potentiometer R154 (gain) alters the response curve's slope.
3. Take the accuracy error data recorded in subparagraph e4, g4, or i and plot it onto the graph constructed in step 2 above.
4. Determine whether R181 or R154 needs to be adjusted. This determination is accomplished as follows:
- If by moving the plot up or down all of the response points can be brought within the upper and lower error limits (Figure 5-7), adjust R181. Figure 5-8 describes the R181 adjustment.
 - If by changing the slope (gain) of the plot all of the response points can be brought within the upper and lower error limits, adjust R154. As a point of fact, however, it is very probable that if the response curve's slope is incorrect,

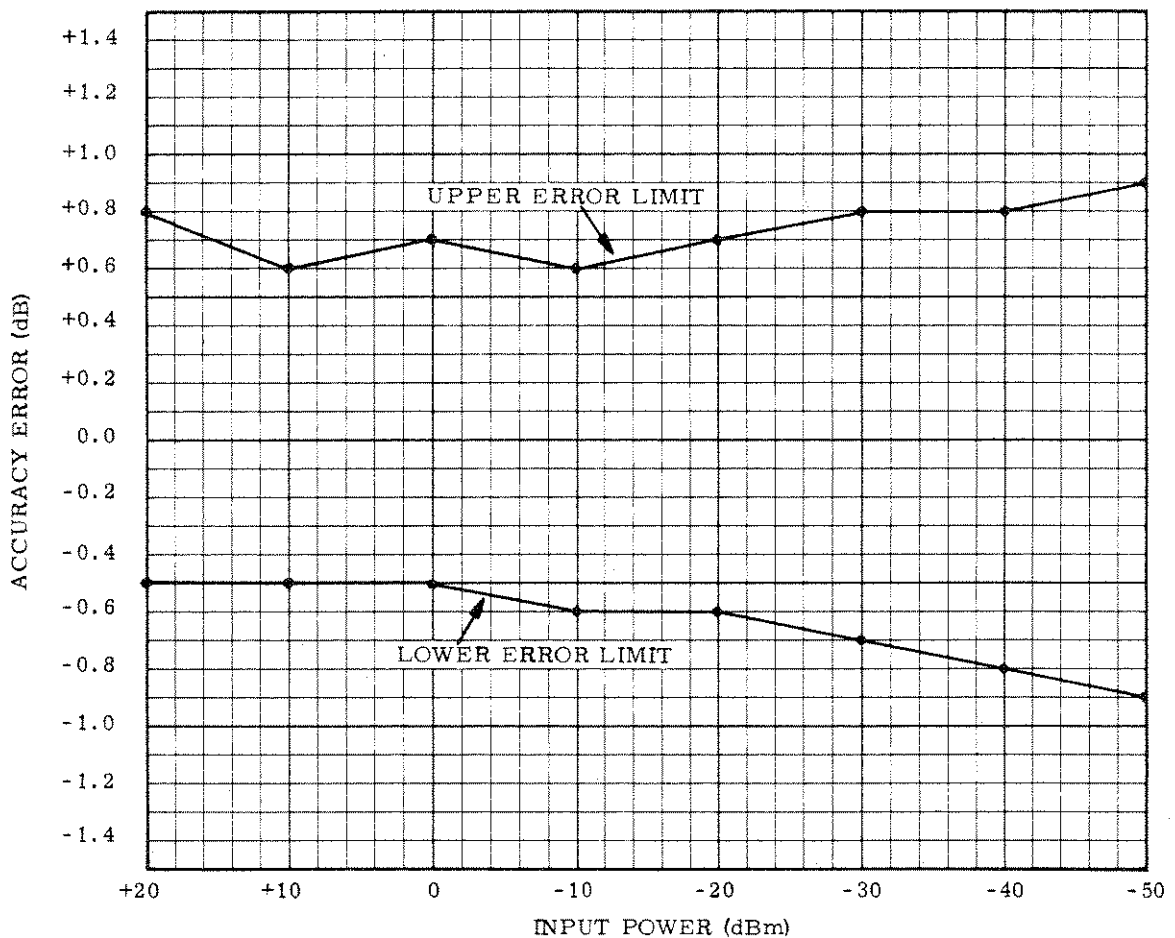

Figure 5-7. A&B Log Amplifier Response Graph

its offset will be incorrect also; consequently, both R181 and R154 will require adjustment. Figure 5-9 describes the adjustment of R181 and R154.

k. Perform Channel R Power Accuracy test as follows:

1. Disconnect RF detector from B and move to R front panel connector.
2. Depress Channel B INPUT R.
3. Adjust OFFSET control for +10.0, as indicated on OFFSET dB display.
4. Insure .2 dB PER DIVISION push-button is depressed.
5. Construct a chart similar to that shown in Table 5-2.
6. Operate the chart in Table 5-2 as follows:

(a) Position 355D to first Attenuator Dial Setting.

(b) Adjust OFFSET control for first OFFSET dB Reading.

(c) Read accuracy error at 50 MHz (center of trace) directly from CRT. If the trace is below the center graticule line, the accuracy error is + (positive); conversely, if the trace is above the center graticule line, the error is - (negative).

(d) Record the accuracy error in the "Accuracy Error" column of the chart.

(e) Repeat steps (a) thru (d) for remaining Attenuator Dial Settings.

m. If Channel R power accuracy readings are clearly out of tolerance (refer to paragraph 4-4), perform Channel R log accuracy adjustments in the same manner described for Channel A&B (refer to subparagraph j, above, and Figures 5-8 and 5-9). For the Channel R response curve, slope is adjusted using R230 and offset (up/down) is adjusted using R294.

5-5 GPIB INTERFACE (A6) PCB ADJUSTMENTS

The adjustments required to calibrate the GPIB interface PCB circuits are described

Table 5-2. Channel R Power Accuracy Chart

Attenuator Dial Setting	OFFSET dB Reading	Accuracy Error	* Tolerance (dB)
0	+10.0		+0.6 -0.5
10	- 0.0		+0.6 -0.5
20	- 10.0		+0.6 -0.5
30	-20.0		+0.7 -0.6
40	-30.0		±0.7

*Tolerance arrived at through a statistical probability formula - refer to paragraph 4-4.1.

Power Accuracy Chart

Attenuator Dial Setting	OFFSET dB Reading	Accuracy Error	* Tolerance (dB)
0	+10.0	+0.3	+0.6
10	- 0.0	0	-0.5
20	-10.0	+0.2	+0.6
30	-20.0	0	-0.5
40	-30.0	-0.4	+0.7
50	-40.0	-1.0	-0.6
60	-50.0	-0.8	±0.9

* Tolerance arrived at through statistical probability formula - refer to paragraph 4-4.1.

ADJUSTMENT PROCEDURE
Offset (R181) Potentiometer

1. Extract error data from power accuracy chart, above.
2. Plot error data on graph.
3. Connect error points together.
4. Study graph. As shown, if the error point at -40 dBm were moved upwards 0.2 dB, all error points would fall within the error range.
5. To make the adjustment, position 355D attenuator dial to 50; adjust OFFSET control for -40.8, as indicated on OFFSET dB display.
6. Adjust R181 counterclockwise to position trace on center graticule line.
7. Recheck power accuracy at all step attenuator dial settings.

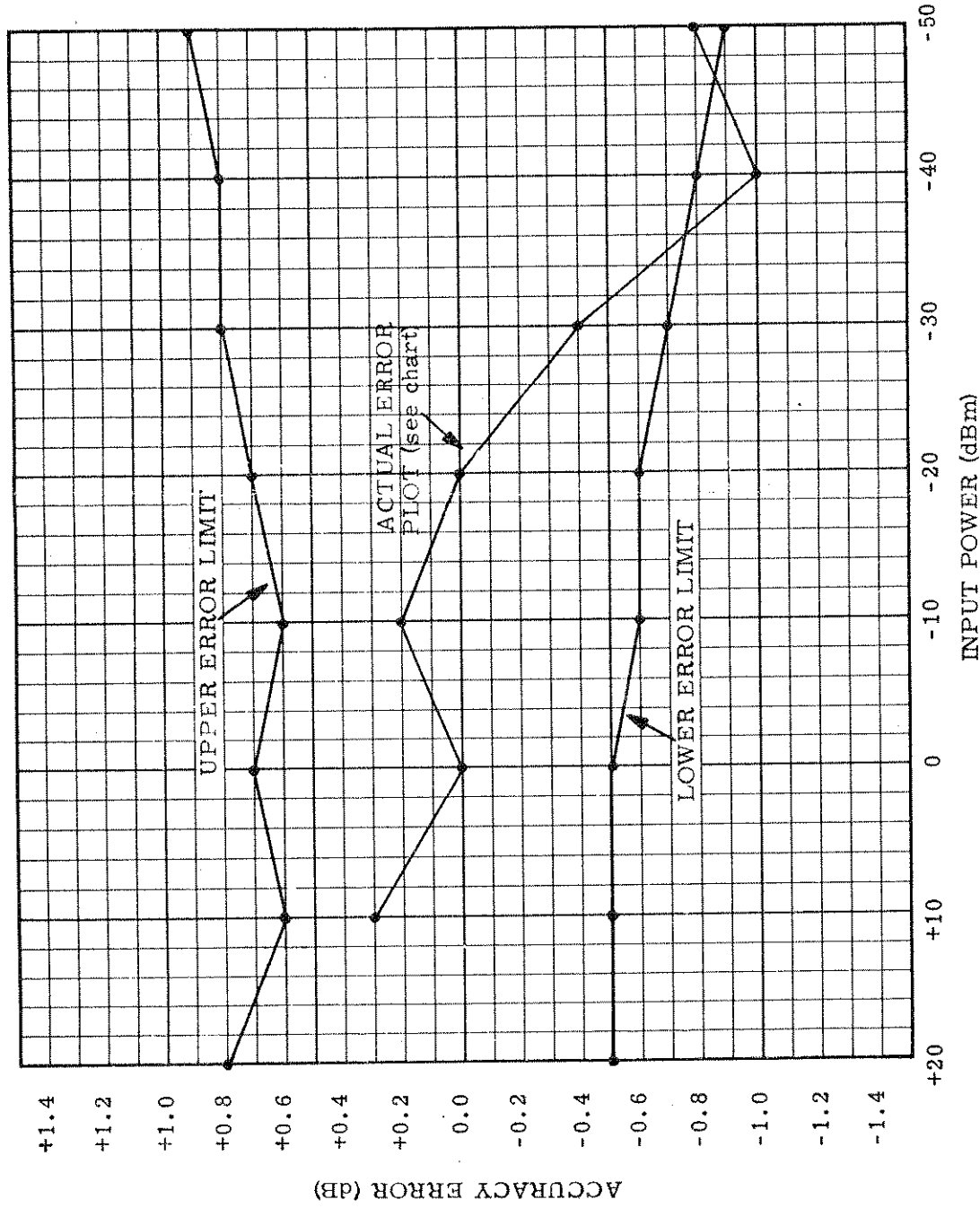

Figure 5-8. Example Describing How To Make R181 OFFSET ADJUSTMENT

Power Accuracy Chart

Attenuator Dial Setting	OFFSET dB Reading	Accuracy Error	*Tolerance (dB)
0	+10.0	+0.2	+0.6 -0.5
10	- 0.0	0.0	+0.7 -0.5
20	-10.0	0.0	±0.6
30	-20.0	-0.4	+0.7 -0.6
40	-30.0	-0.7	+0.8 -0.7
50	-40.0	-1.0	±0.8
60	-50.0	-1.3	±0.9

* Tolerance arrived at through a statistical probability formula - refer to paragraph 4-4.1.

ADJUSTMENT PROCEDURE
Gain (R154) and Offset (R181) Potentiometers

1. Extract error data from power accuracy chart, above.
2. Plot error data on graph.
3. Draw straight line between the error point at +10 dBm and the error point at -50 dBm.
4. Study graph. As shown, the response curve needs two corrections: slope and offset (up/down). R154 needs to correct slope approximately -1.0 dB; R181 needs to correct offset approximately +1.2 dB. Adjust offset first, then adjust slope.
5. To make the adjustments:
 - a. Position 355D attenuator dial to 60; adjust OFFSET control for -50.0, as indicated on OFFSET dB display.
 - b. Adjust R181 counterclockwise to position trace on center graticule line.
 - c. Position 355D attenuator dial to 0; adjust OFFSET control for +10.0, as indicated on OFFSET dB display.
 - d. Adjust R154 counterclockwise to position trace on center graticule line.
6. Recheck power accuracy at -50 dBm. If OFFSET dB reading is still out of tolerance, construct a new graph and repeat steps 5a thru d, above, until all power accuracy readings are within the error range.

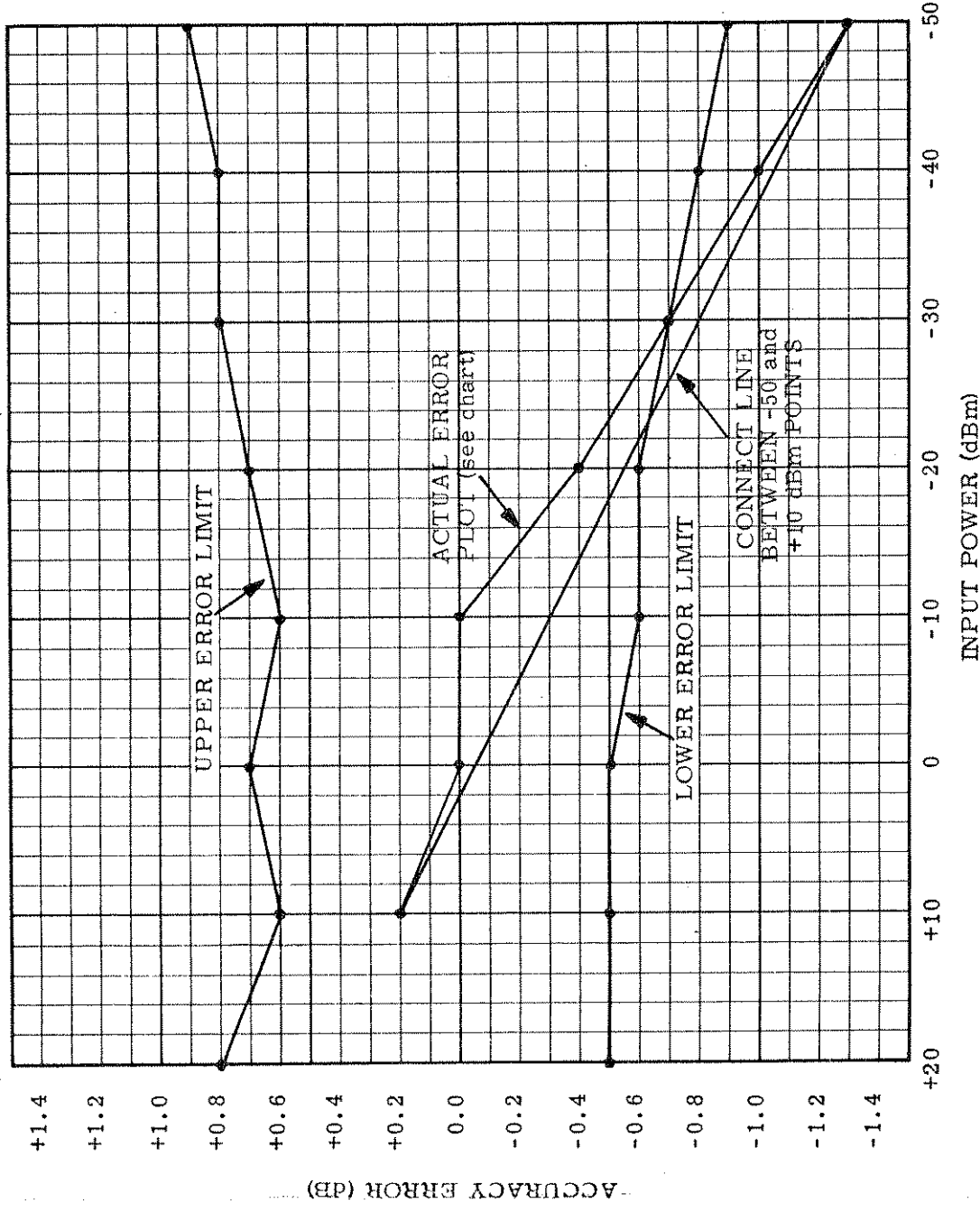

Figure 5-9. Example Describing How To Make R181/R154 OFFSET/SLOPE ADJUSTMENTS

below. These adjustments should be performed by qualified personnel, and only when the performance verification tests of Section IV indicate an out of tolerance condition exists. Calibration of the A6 PCB requires a sweep generator, a GPIB controller, and an oscilloscope. To calibrate the A6 PCB, proceed as follows:

- a. Perform the GPIB checks in paragraph 4-3.3.
- b. Gain access to the A6 PCB (paragraph 5-2).

CAUTION

Avoid contact with the ground tab on VR2. This tab is at a -18 Vdc potential. If the VR2 tab is shorted to ground, damage to A6 components will result.

- c. Turn on 560A power and program controller to take data continuously from Channel A; see program below.

```

10 OUTPUT 706;"AI"
20 ENTER 706;X
30 DISP X
40 WAIT 50
50 GO TO 10
60 END

```

HP 85 Program

```

0: wrt 706;"AI"
1: red 706;X
2: dsp X
3: wait 50
4: sto 0

```

HP 9825A Program

- d. Calibrate amplifier offset potentiometer A6R8 as follows:

- 1. Connect clip leads between test

points A6TP12 and A6TP14 (Figure 5-11).

- 2. Connect oscilloscope to test point A6TP9.
- 3. Set vertical sensitivity to 10 mV/division; set horizontal time base to 10 ms/division.
- 4. Adjust A6R8 for lowest voltage point (maximum dip).
- e. Calibrate A/D converter offset potentiometer A6R9 as follows:
 - 1. Adjust A6R9 so that the controller display reads 00.01 dBm.
- f. Calibrate +/- sign comparator reference potentiometer A6R29 as follows:
 - 1. Connect oscilloscope to test points A6TP10.
 - 2. Set vertical sensitivity to 2 volts/division.
 - 3. Adjust A6R29 until a 0 to \approx +4V band of noise appears on the oscilloscope.
- g. Calibrate amplifier gain potentiometer A6R41 as follows:
 - 1. Disconnect clip leads from test points A6TP12 and A6TP14. Set sweep generator output to +10.0 dBm.
 - 2. Estimate absolute power reading to the nearest .01 dBm as follows:
 - (a) Adjust Channel A OFFSET dB to place the trace on top of the center horizontal graticule line.
 - (b) Decrease OFFSET dB readout by .1 dB. For example, if the OFFSET dB readout was +10.0 dBm, decrease it to +9.9 dBm.
 - (c) Determine the distance from the trace to the center horizontal graticule line, to the nearest .01

- of a division. Multiply the value by .2 dB/division to determine the value in dB's.
- (d) If the trace is above the center graticule line, subtract the value determined in step (c) from the OFFSET dB readout in step (b). If the trace is below the center graticule line, add the value determined in step (c) to the OFFSET dB readout determined in step (b). For example, if the trace is .15 dB below the center graticule horizontal line and the OFFSET dB readout indicates +9.9 dBm, then add .15 dB and +9.9 dBm, for a final value of 10.05 dBm.
3. Set attenuator to 30 dB.
 4. Adjust OFFSET dB control so trace is on top of the center horizontal graticule line (≈ -30.0 dBm).
 5. Estimate absolute power reading to the nearest .01 dBm, ± 0.3 dB, using the method listed in step 2.
 6. Adjust amplifier gain potentiometer A6R41 for a controller power reading that is the same as the absolute power determined in step 5.
 7. Set attenuator to 10 dB.
 8. Adjust OFFSET dB control so trace is on top of the center horizontal graticule line ($\approx +10.0$ dBm).
 9. Determine absolute power reading to the nearest .01 dB using the method listed in step 2.
 10. Adjust A6R8 for a controller power reading that is the same as the absolute power reading determined in step 9.
- h. Calibrate -30 dBm comparator reference potentiometer A6R37 as follows:
1. Adjust OFFSET dB control for a -30.0 dBm reading.
 2. On sweep generator, manually adjust RF output so trace is on top of the 560A's center horizontal graticule line.
 3. Connect oscilloscope to test point A6TP15.
 4. Adjust A6R37 counterclockwise until the oscilloscope shows a waveform switching back and forth between $\approx +5V$ and $0V$.
 5. Adjust A6R37 clockwise until the oscilloscope shows a waveform at $\approx +5V$, with local calibrate pulses running across the screen.

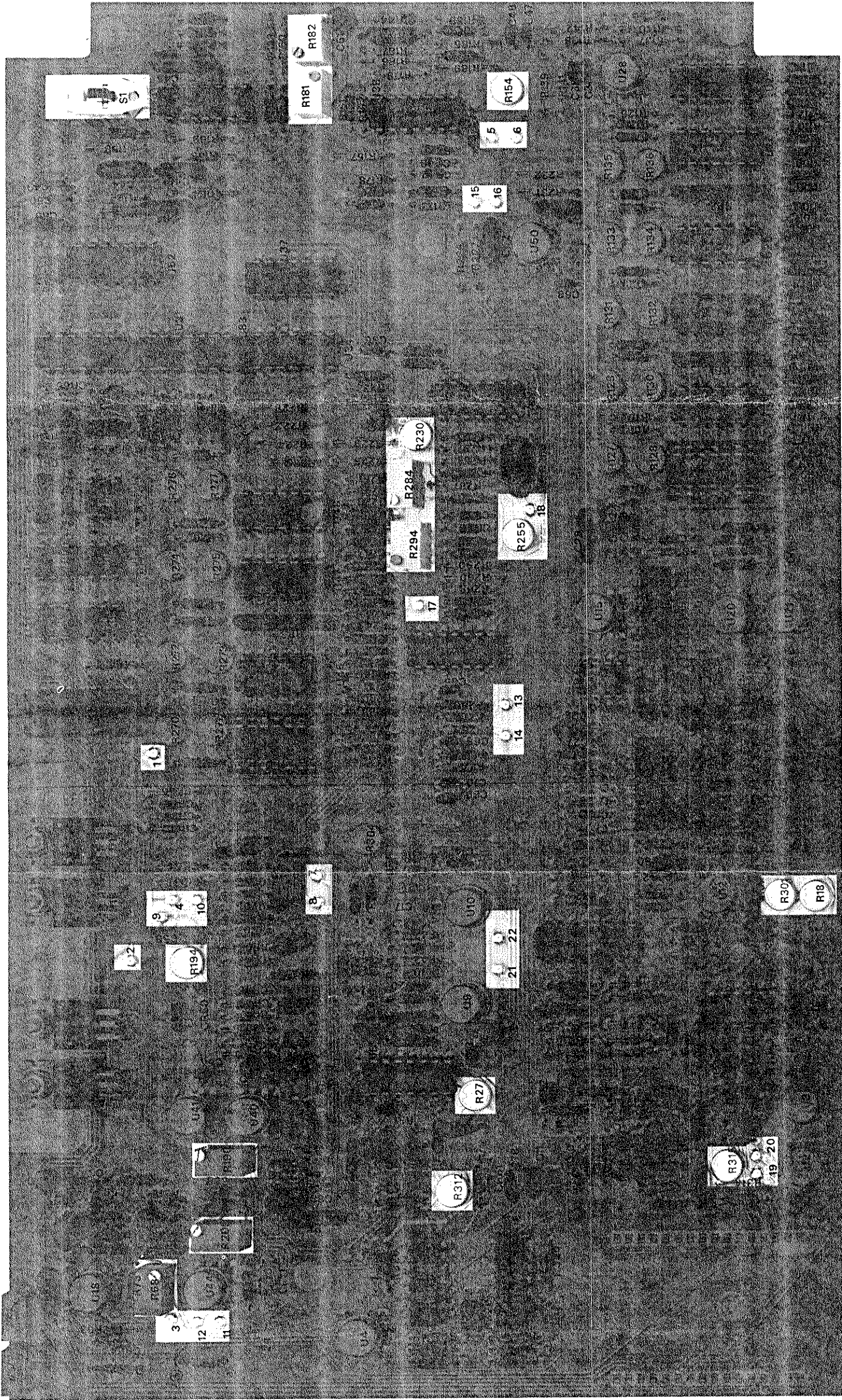

Figure 5-10. Locations of Test Points and Potentiometers, A3 PCB

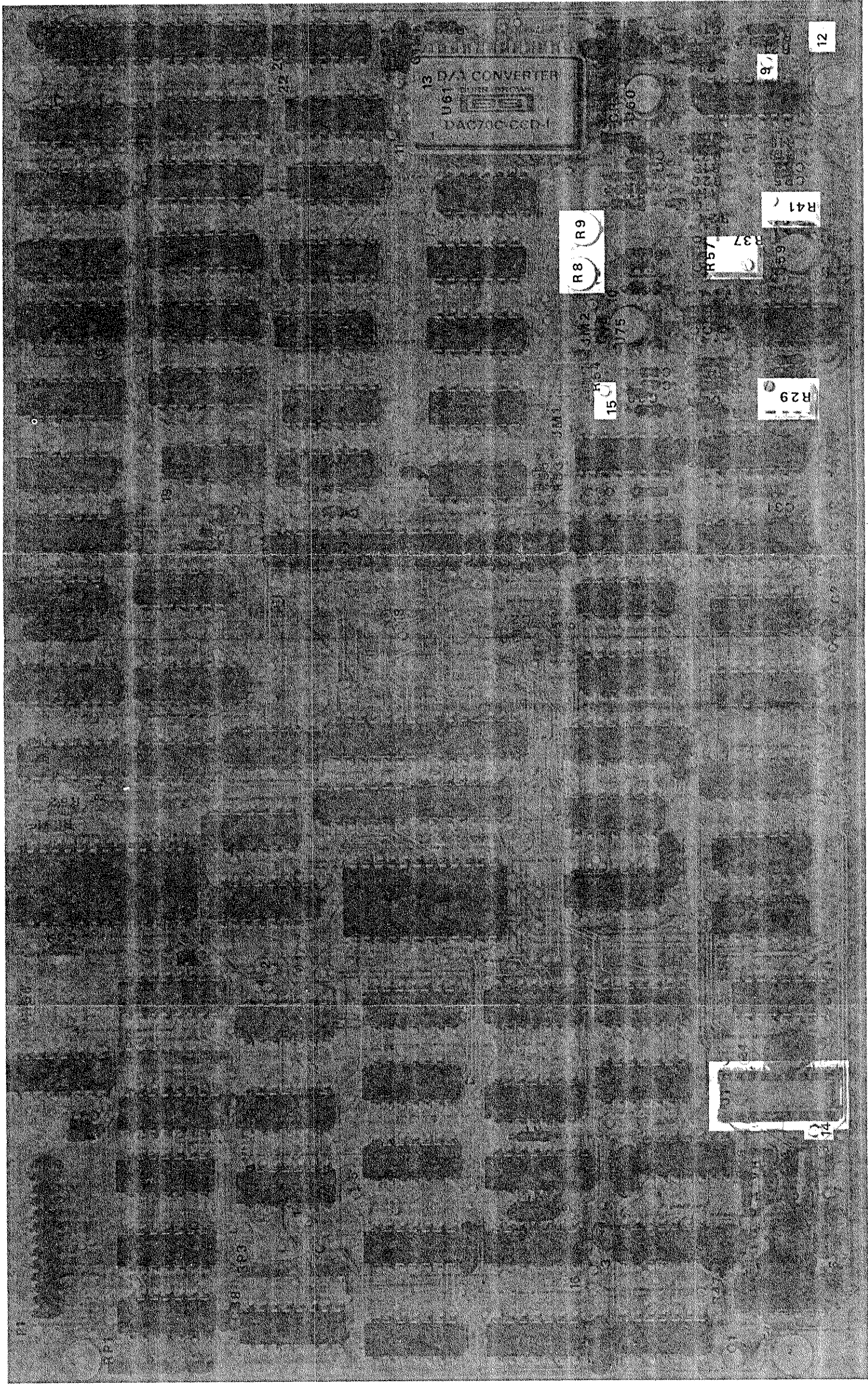

Figure 5-11. Locations of Test Points and Adjustments, A6 PCB

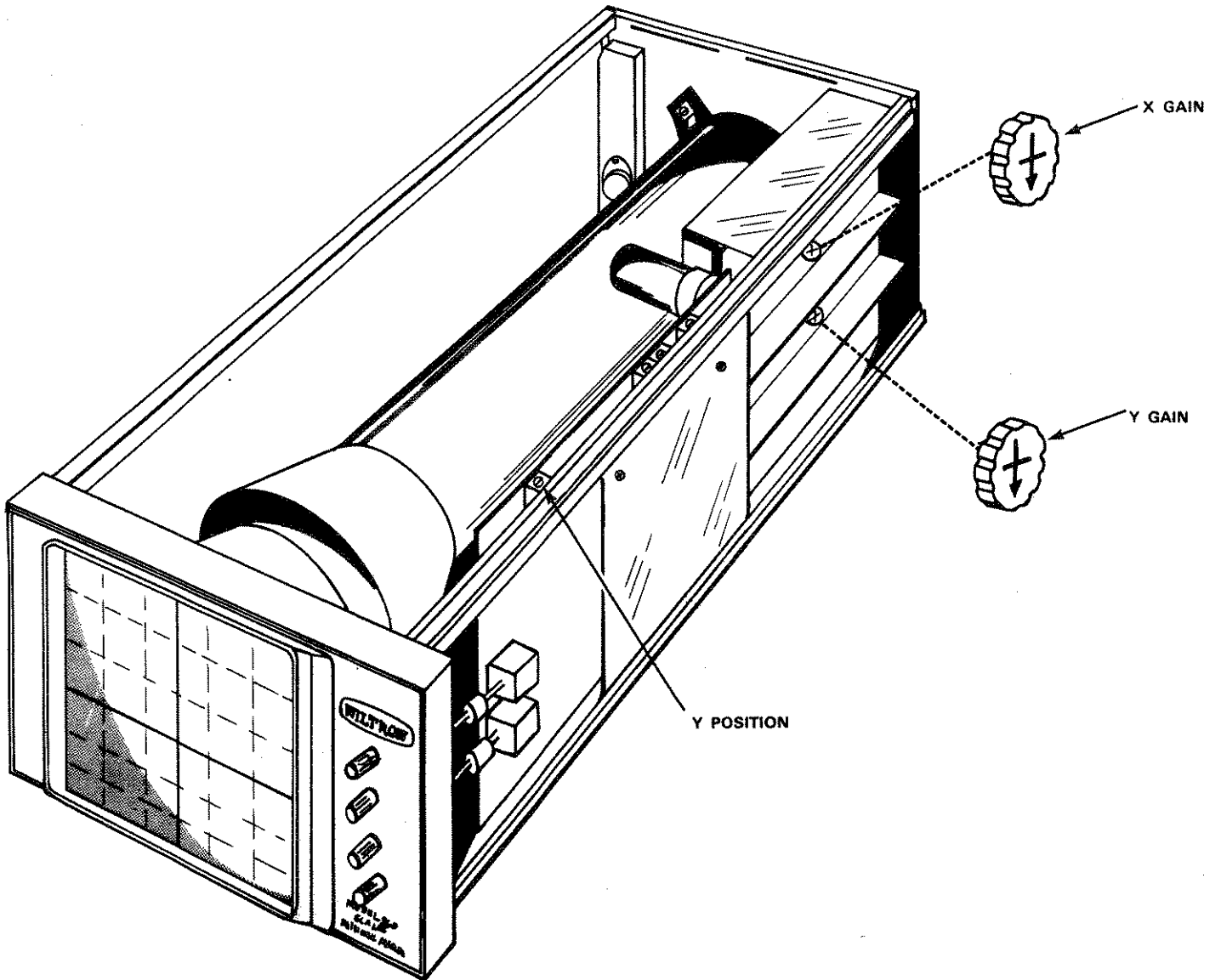

Figure 5-12. Locations of Test Points and Potentiometers, CRT Mainframe

← Figure 5-11.

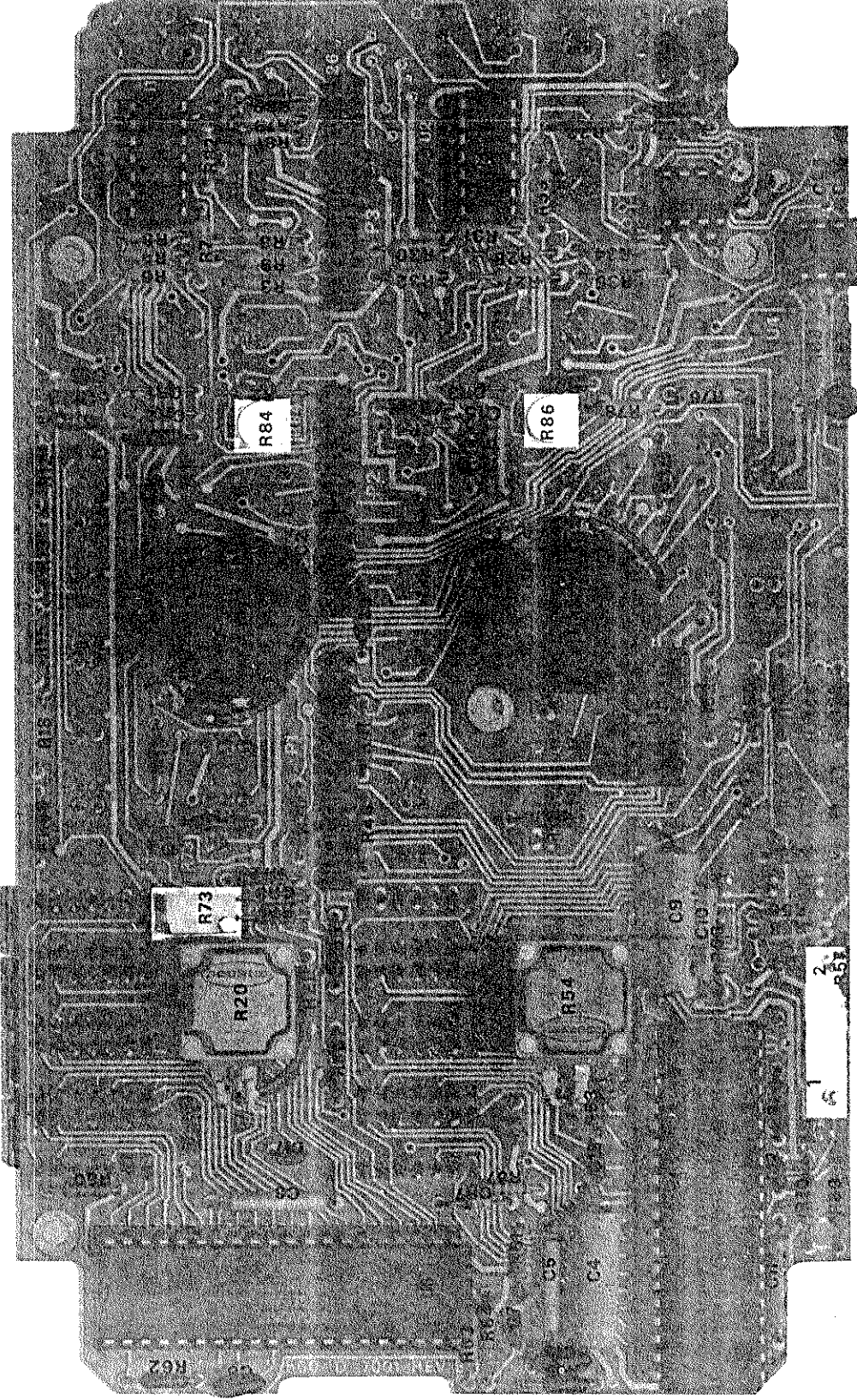
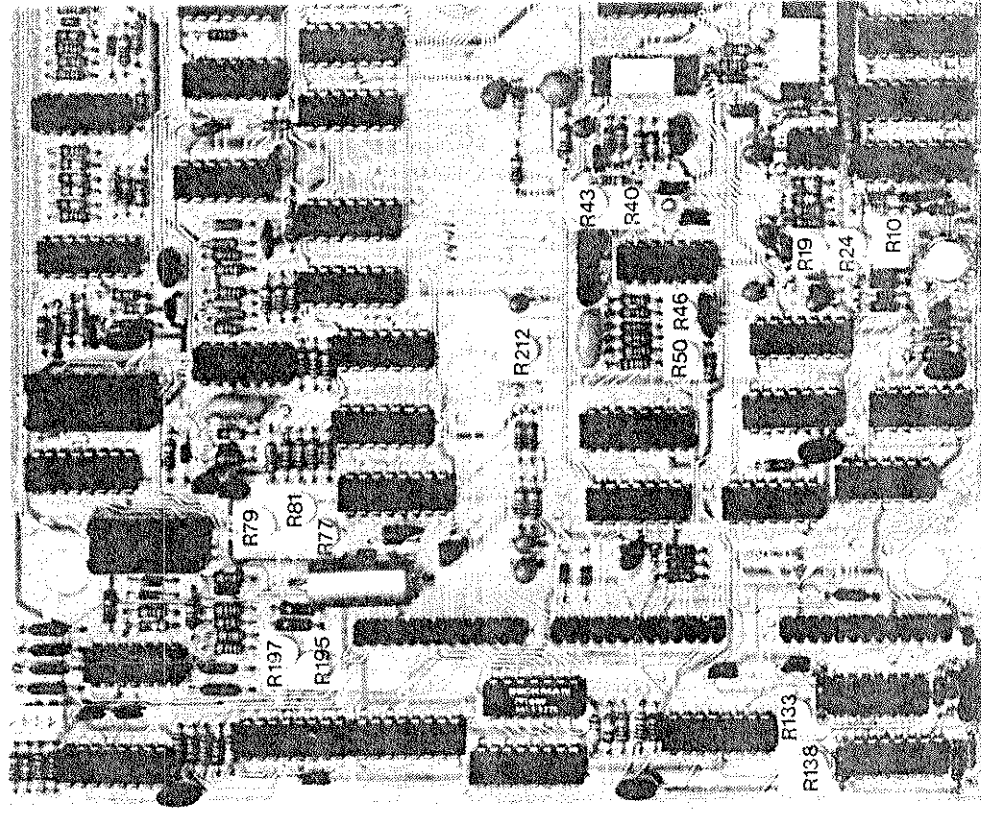

Figure 5-13. Locations of Test Points and Potentiometers, A1 PCB

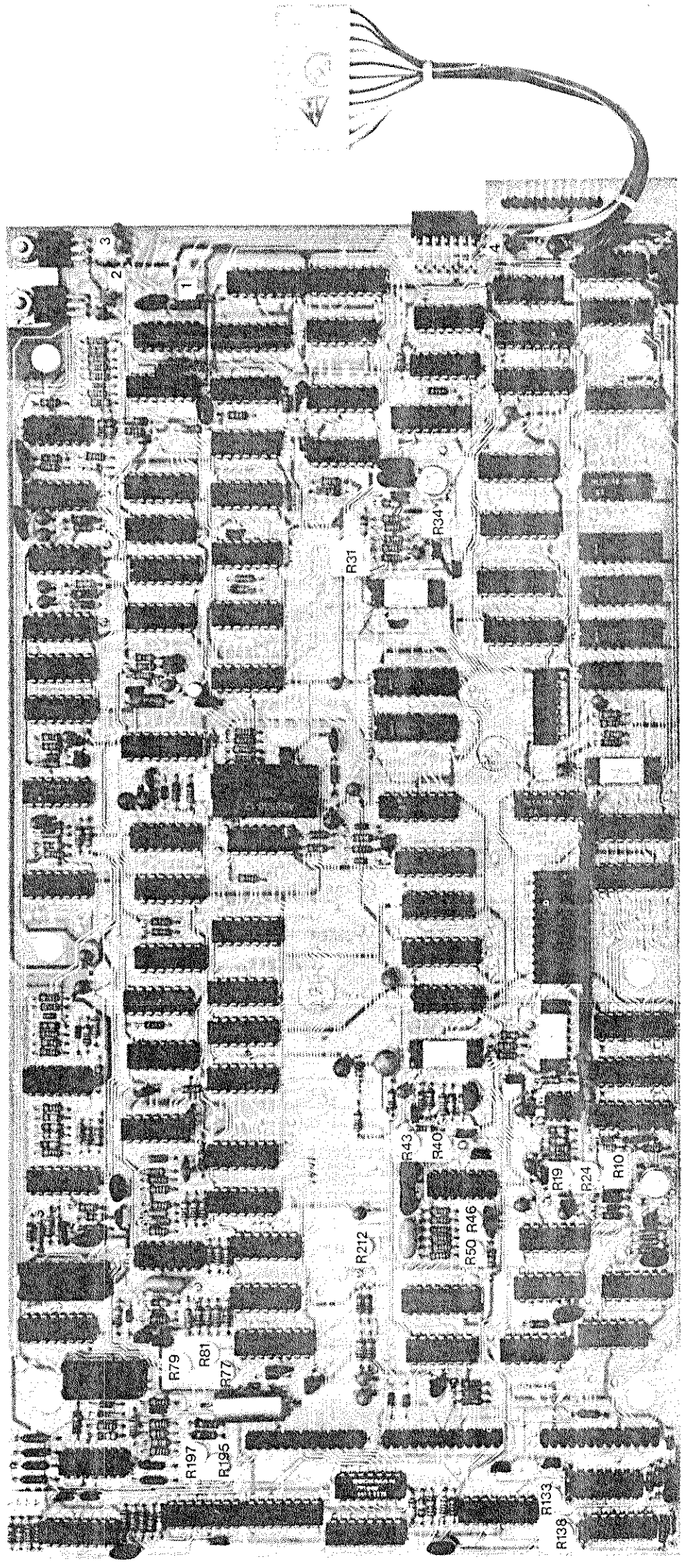
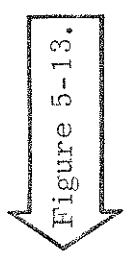

Figure 5-14. Locations of Test Points and Potentiometers, A2 PCB



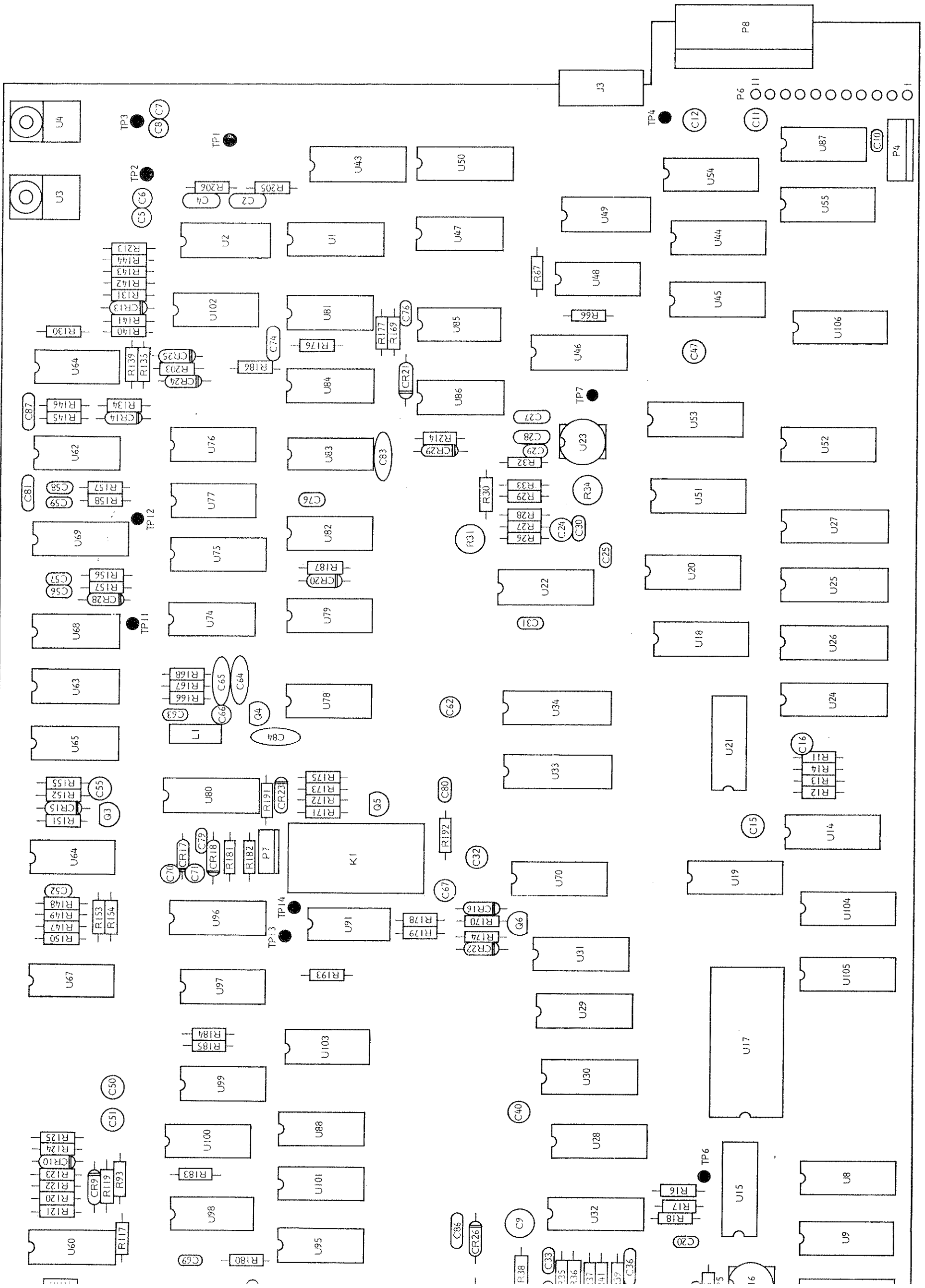

Fig. 5-15 A2 (Digital) board

