

PRICE \$1.00



Assembling  
and Using Your...

# Heathkit

**Q MULTIPLIER**

MODEL QF-1

**HEATH COMPANY**

*A Subsidiary of Daystrom Inc.*

**BENTON HARBOR, MICHIGAN**

# STANDARD COLOR CODE — RESISTORS AND CAPACITORS

<p><b>AXIAL LEAD RESISTOR</b></p> <p>Brown — Insulated Black — Non-insulated</p>	<table border="1"> <thead> <tr> <th>INSULATED UNINSULATED Color</th> <th>FIRST RING BODY COLOR First Figure</th> <th>SECOND RING END COLOR Second Figure</th> <th>THIRD RING DOT COLOR Multiplier</th> </tr> </thead> <tbody> <tr><td>BLACK</td><td>0</td><td>0</td><td>None</td></tr> <tr><td>BROWN</td><td>1</td><td>1</td><td>0</td></tr> <tr><td>RED</td><td>2</td><td>2</td><td>00</td></tr> <tr><td>ORANGE</td><td>3</td><td>3</td><td>,000</td></tr> <tr><td>YELLOW</td><td>4</td><td>4</td><td>0,000</td></tr> <tr><td>GREEN</td><td>5</td><td>5</td><td>00,000</td></tr> <tr><td>BLUE</td><td>6</td><td>6</td><td>000,000</td></tr> <tr><td>VIOLET</td><td>7</td><td>7</td><td>0,000,000</td></tr> <tr><td>GRAY</td><td>8</td><td>8</td><td>00,000,000</td></tr> <tr><td>WHITE</td><td>9</td><td>9</td><td>000,000,000</td></tr> </tbody> </table>	INSULATED UNINSULATED Color	FIRST RING BODY COLOR First Figure	SECOND RING END COLOR Second Figure	THIRD RING DOT COLOR Multiplier	BLACK	0	0	None	BROWN	1	1	0	RED	2	2	00	ORANGE	3	3	,000	YELLOW	4	4	0,000	GREEN	5	5	00,000	BLUE	6	6	000,000	VIOLET	7	7	0,000,000	GRAY	8	8	00,000,000	WHITE	9	9	000,000,000	<p><b>DISC CERAMIC RMA CODE</b></p>
INSULATED UNINSULATED Color	FIRST RING BODY COLOR First Figure	SECOND RING END COLOR Second Figure	THIRD RING DOT COLOR Multiplier																																											
BLACK	0	0	None																																											
BROWN	1	1	0																																											
RED	2	2	00																																											
ORANGE	3	3	,000																																											
YELLOW	4	4	0,000																																											
GREEN	5	5	00,000																																											
BLUE	6	6	000,000																																											
VIOLET	7	7	0,000,000																																											
GRAY	8	8	00,000,000																																											
WHITE	9	9	000,000,000																																											
<p><b>RADIAL LEAD DOT RESISTOR</b></p>	<p><b>5-DOT RADIAL LEAD CERAMIC CAPACITOR</b></p>	<p><b>EXTENDED RANGE TC CERAMIC HICAP</b></p>																																												
<p><b>RADIAL LEAD (BAND) RESISTOR</b></p>	<p><b>BY-PASS COUPLING CERAMIC CAPACITOR</b></p>	<p><b>AXIAL LEAD CERAMIC CAPACITOR</b></p>																																												

The standard color code provides all necessary information required to properly identify color coded resistors and capacitors. Refer to the color code for numerical values and the zeroes or multipliers assigned to the colors used. A fourth color band on resistors determines tolerance rating as follows: Gold = 5%, silver = 10%. Absence of the fourth band indicates a 20% tolerance rating.

The physical size of carbon resistors is determined by their wattage rating. Carbon resistors most commonly used in Heathkits are 1/2 watt. Higher wattage rated resistors when specified are progressively larger in physical size. Small wire wound resistors 1/2 watt, 1 or 2 watt may be color coded but the first band will be double width.

## MOLDED MICA TYPE CAPACITORS

<p><b>CURRENT STANDARD CODE</b></p> <p>JAN &amp; 1948 RMA CODE</p>	<p><b>RMA 3-DOT (OBSOLETE) RATED 500 W.V.D.C. ± 20% TOL.</b></p>	<p><b>BUTTON SILVER MICA CAPACITOR</b></p>
<p><b>RMA (5-DOT OBSOLETE CODE)</b></p>	<p><b>RMA 6-DOT (OBSOLETE)</b></p>	<p><b>RMA 4-DOT (OBSOLETE)</b></p>

## MOLDED PAPER TYPE CAPACITORS

<p><b>TUBULAR CAPACITOR</b></p> <p>Normally stamped for value</p> <p>A 2 digit voltage rating indicates more than 900 V. Add 2 zeros to end of 2 digit number.</p>	<p><b>MOLDED FLAT CAPACITOR Commercial Code</b></p>	<p><b>JAN. CODE CAPACITOR</b></p>
--	---	-----------------------------------

The tolerance rating of capacitors is determined by the color code. For example: red = 2%, green = 5%, etc. The voltage rating of capacitors is obtained by multiplying the color value by 100. For example: orange = 3 × 100 or 300 volts. Blue = 6 × 100 or 600 volts.

In the design of Heathkits, the temperature coefficient of ceramic or mica capacitors is not generally a critical factor and therefore Heathkit manuals avoid reference to temperature coefficient specifications.

# ASSEMBLY AND OPERATION OF THE HEATHKIT Q MULTIPLIER MODEL QF-1

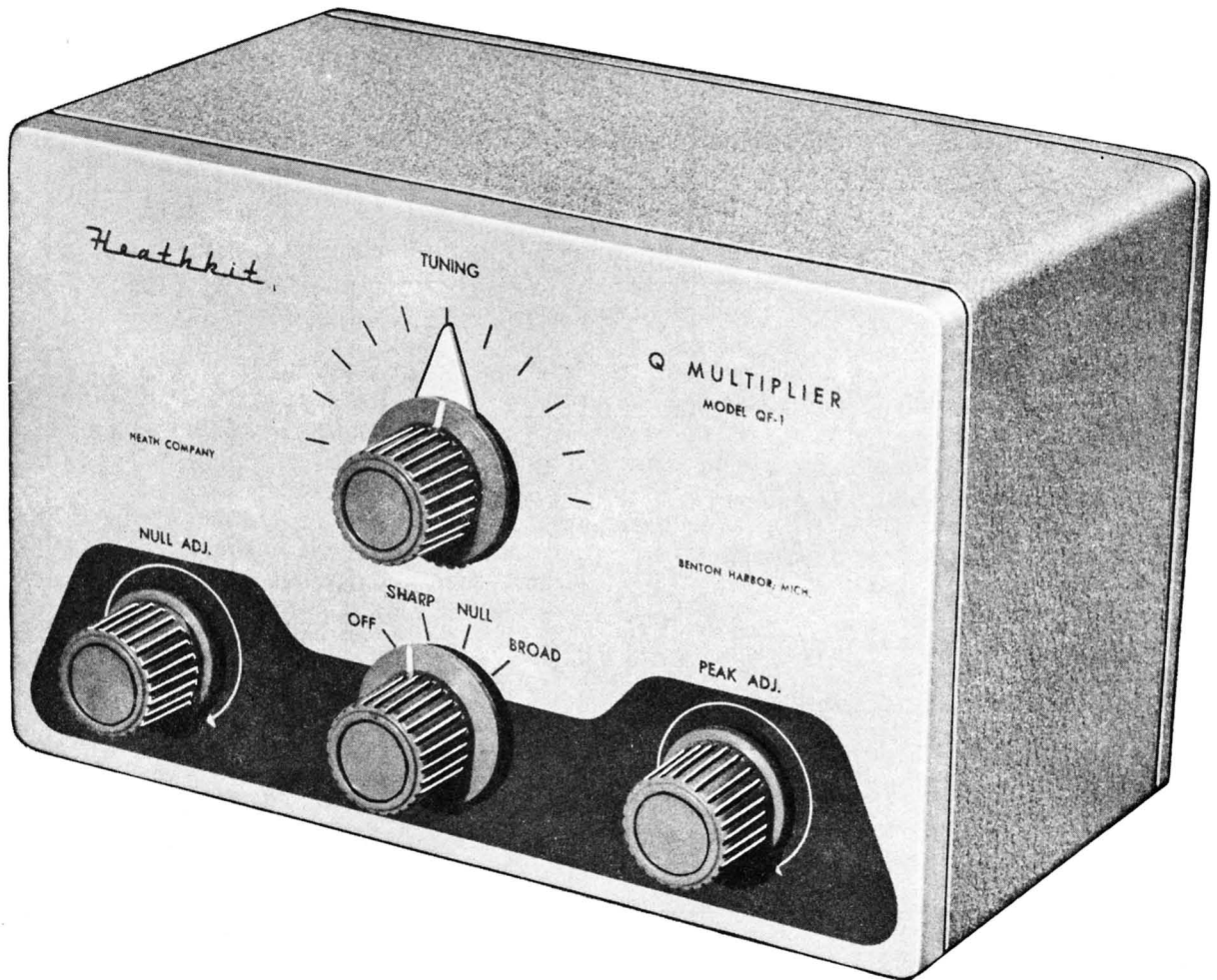

## SPECIFICATIONS

Operating Frequency.....	450-460 kc
Operation.....	OFF - SHARP PEAK - NULL - BROAD PEAK
Tube Complement.....	.12AX7 multiplier
Power Requirements.....	6.3 volts AC 300 ma, 150-250 volts DC 2 ma
Cabinet Size.....	7 3/8" wide x 4 11/16" high x 4 1/8" deep
Net Weight.....	1 1/2 lbs.
Shipping Weight.....	3 lbs.

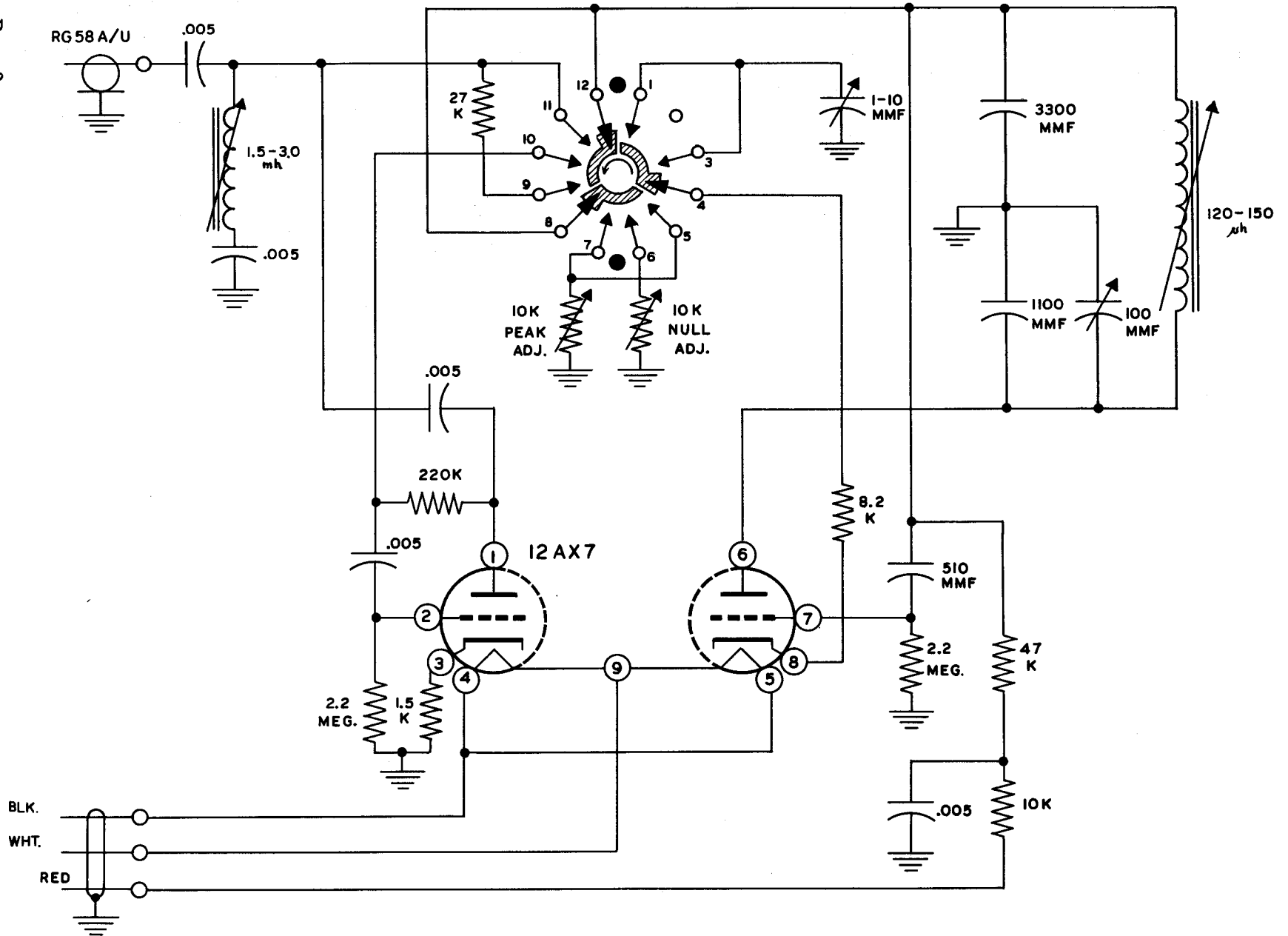

SCHEMATIC OF Q MULTIPLIER OF-1

## INTRODUCTION

The Heathkit model QF-1 Q Multiplier when used with a communications receiver, provides additional selectivity or signal rejection as desired. Because the peak or null effect of the Q Multiplier may be tuned across the receiver's IF bandpass, its operation is more flexible than that of a crystal filter. The Q Multiplier may be used with a receiver which already has a crystal filter to obtain two simultaneous functions. For example, the receiver's crystal filter could be set to peak the desired signal and the Q Multiplier used to null an adjacent signal.

The QF-1 requires very little power in either filament AC or B+, consequently, it can derive its power from any receiver without overloading the receiver power supply. When properly connected and adjusted, it will not decrease the receiver sensitivity and may even increase it. In peak position, an audible gain will be noted on CW signals; on phone signals a carrier gain will be noted on the S meter. However, the audio will be down slightly due to narrowing of the transmitted sidebands.

The reduced sideband reception will tend to attenuate the higher audio frequencies. This is more than compensated for by the increased readability against the surrounding QRM.

## CIRCUIT DESCRIPTION

The Q Multiplier functions as a very high Q circuit coupled in parallel across the IF transformer for peak or by inversion through another triode tube section, in series for null. Any high Q circuit tends to have a very sharp point of resonance as either a series or parallel tuned circuit.

As the Q of the circuit is increased, the side slope of the resonant peak or dip becomes steeper. A parallel circuit has a very high impedance at resonance and a series circuit a very low impedance, consequently when circuits of this type are connected in shunt across the receiver IF circuit, the following action takes place. As a parallel circuit, any signal passing through the IF at the resonant frequency of the Q Multiplier sees a very high shunt impedance and is not attenuated, whereas signals slightly off the resonant frequency fall along the slope or "skirt" of the Q Multiplier bandpass and seeing a relatively low impedance, are shunted to ground. See Figure 1. By means of the variable capacitor in the QF-1, this peak can be tuned to any place in the IF bandpass to peak one signal and attenuate all others.

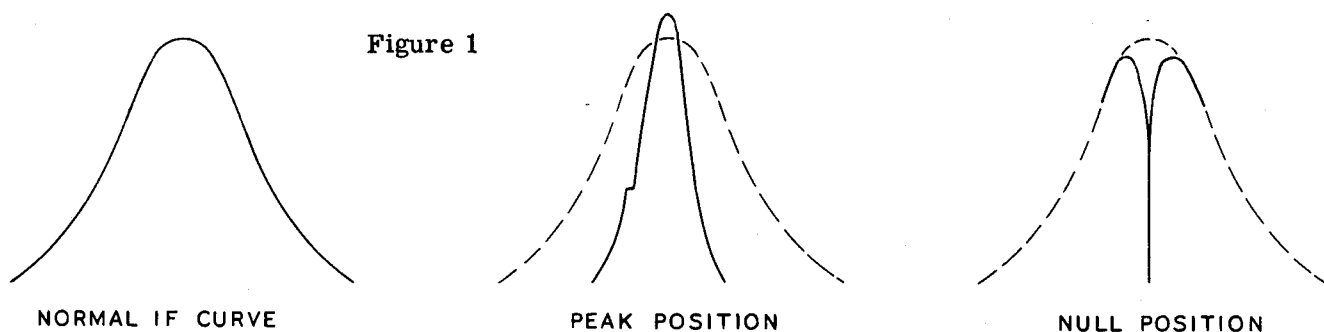

In the null position, any signal passing at the series resonant frequency of the Q Multiplier sees a very low impedance to ground and is rejected at this point. The series resonance can also be moved across the IF pass band, consequently a heterodyne adjacent to the desired signal can be dropped into the notch and eliminated.

Basically, the Q multiplier bears a resemblance to the old regenerative IF but is capable of higher Q and is more versatile. The circuit is centered around a coil having a Q of 200 or more (#40-68) and this coil's Q amplified by positive feedback in one triode section of the 12AX7 tube to an apparent Q of approximately 4000. This compares very favorably with the Q of the quartz crystal used in crystal filters. The other triode section of the 12AX7 tube is switched in as a negative feedback circuit to form the null circuit. The remaining coil (#40-67) is used to tune out the capacity of the coaxial cable connecting the Q Multiplier to the receiver IF stage. This is necessary to prevent detuning the receiver IF by the cable capacity.

## NOTES ON ASSEMBLY AND WIRING

The components furnished with your QF-1 are of excellent electrical quality and are reasonably strong. However, all parts should be handled with due care and consideration for the weak points inherent in certain components.

The terminals on the coils should not be subjected to undue strain while making connections. This also applies to switch terminals. During the process of assembly and wiring, the rotor plates of the variable capacitor should be kept fully meshed to prevent possible damage to this part. Many of the resistors and capacitors are mounted with short leads and should be for proper operation. This entails greater care in soldering to prevent damage by overheating while making a good soldered connection.

This manual is supplied to assist you in every way to complete the QF-1 with the least chance of error. We suggest that you take a few minutes now and read the entire manual through with the exception of the Step-By-Step Assembly. In so doing, you will receive an overall picture of the principle and use of a Q multiplier. The large pictorial is handy to attach to the wall above your work space. It is also reproduced in smaller form in the manual. We suggest that you retain the manual for future reference, both in the use of the QF-1 and for its maintenance.

**UNPACK THE KIT CAREFULLY AND CHECK EACH PART AGAINST THE PARTS LIST.** In so doing, you will become acquainted with each part. Refer to the charts and other information shown on the inside covers of the manual to help you identify any parts about which there may be a question. If some shortage is found in checking the parts, please notify us promptly and return the inspection slip with your letter to us. Hardware items are counted by weight and if a few are missing, please obtain them locally if at all possible.

Read the note on soldering on the inside of the back cover. Crimp all leads tightly to the terminal before soldering. Be sure both the lead and terminal are free of wax, corrosion or other foreign substances. Use only the best rosin core solder, preferably a type containing the new activated fluxes such as Kester "Resin-Five," Ersin "Multicore" or similar types.

**NOTE: ALL GUARANTEES ARE VOIDED AND WE WILL NOT REPAIR OR SERVICE INSTRUMENTS IN WHICH ACID CORE SOLDER OR PASTE FLUXES HAVE BEEN USED. WHEN IN DOUBT ABOUT SOLDER, IT IS RECOMMENDED THAT A NEW ROLL PLAINLY MARKED "ROsin CORE RADIO SOLDER" BE PURCHASED.**

Resistors and capacitors generally have a tolerance rating of  $\pm 10\%$  unless otherwise stated in the parts list. Therefore, a 100 K $\Omega$  resistor may test anywhere from 90 K $\Omega$  to 110 K $\Omega$ . The letter K is commonly used to designate a multiplier of 1000.

In order to expedite delivery to you, we are occasionally forced to make minor substitutions of parts. Such substitutions are carefully checked before they are approved and the parts supplied will work satisfactorily. By checking the parts list for resistors, for example, you may find that a 2 K $\Omega$  resistor has been supplied in place of a 2.2 K $\Omega$  as shown in the parts list. These changes are self-evident and are mentioned here only to prevent confusion in checking the contents of your kit. The parts furnished with your Heathkit will not adversely affect the operation of the finished instrument. We strongly urge that you follow the wiring and parts layout shown in the manual. The position of wires and components is somewhat critical in a Q multiplier and changes may seriously affect the characteristics of the circuit.

Resistors and capacitors usually have leads longer than necessary to make the indicated connections. Both in the interest of efficiency and appearance, the leads should be cut to an appropriate length before the connections are made. In designating color code on mica capacitors, only the significant colors will be given.

## STEP-BY-STEP ASSEMBLY INSTRUCTIONS

The following instructions are presented in a simple, logical, step-by-step sequence to enable you to complete your kit with the least possible confusion.

Be sure to read each step all the way through before starting. When a step is completed, check it off in the space provided. This makes it easy to resume construction after your work has been interrupted.

**NOTE:** We suggest you do the following before any work is started:

1. Attach the large pictorial to the wall above your work space.
2. After identifying the components from the parts list, place them in a shallow box so that they are readily accessible. This will save considerable time in construction.
3. Thoroughly read the assembly and wiring instructions on the inside rear cover of the manual and refer to the general information on both inside covers to identify the parts.
4. In assembling the kit, use lockwashers under all nuts unless a solder lug is used or unless otherwise specified.

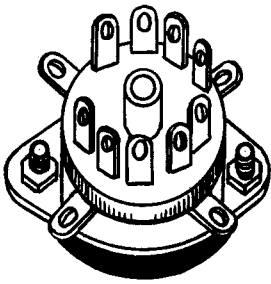

- ( ) Mount a 9-pin miniature socket in the 3/4" hole near the chassis bottom, using 3-48 screws, lockwashers and nuts. Position the socket so the pins appear as shown in Figure 2.

- ( ) Mount the 1-10  $\mu\text{mf}$  trimmer capacitor by pushing the mounting clip through the 5/16" hole until it catches (see Figure 2). The stator terminal should face toward the chassis rear. This trimmer capacitor and the two coils have a small locating projection on one side of the mounting clip. This should be bent back or broken off before the clip is pushed into the mounting hole.

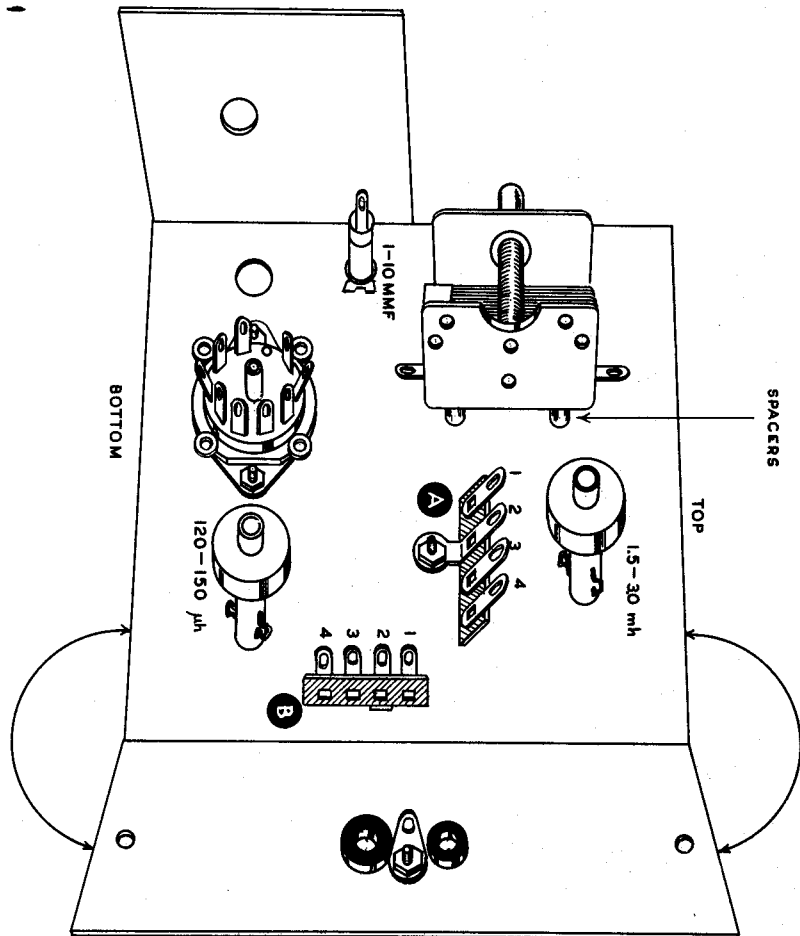

Figure 2

- ( ) Select a 1.5 K $\Omega$  resistor (brown-green-red). It is easy to confuse this resistor with the 2.2 megohm resistor, so check the color code carefully. Bend one end of the resistor to an acute angle about 3/8" from the resistor body. Pass this lead up through the #1 ground lug, between pins 1 and 9 of the socket, to the socket center post and solder both connections. See Pictorial 1 on Page 7.



- ( ) Cut the other resistor lead to 3/8" and connect to socket pin 3 (S). Keep the resistor close to the tube socket.
- ( ) Cut one lead of a 2.2 megohm resistor (red-red-green) to 5/8" and the other lead to 1/2". Bend the leads as shown in Pictorial 1. Connect the 5/8" lead to ground lug 2 (S) and the 1/2" lead to pin 2 (NS).
- ( ) Cut both leads of a 2.2 megohm resistor to 1/2" and connect from ground lug 3 (S) to pin 7 (NS).
- ( ) Mount the 100  $\mu\mu\text{f}$  tuning capacitor near the top front of the chassis in the following manner. First bend the capacitor terminals at right angles as shown in Figure 2. Insert four 4-40 x 3/8" screws through the 1/8" holes and place 3/16" spacers over them. Place the capacitor over the screws, and holding the screws with the fingers and the capacitor with the thumb of one hand, start each screw separately. When all screws are started, align the capacitor squarely and tighten all screws.
- ( ) Mount the two 4-lug terminal strips in the positions shown in Figure 2, using 6-32 screws, lockwashers and nuts.
- ( ) Mount two 5/16" grommets on the rear chassis apron as shown.
- ( ) Bend a solder lug at right angles 3/8" from the narrow end and mount it between the grommets. Do not use a lockwasher here.

NOTE: In order to show the wiring on the pictorial drawing, the coil terminals are not illustrated in their exact position. The terminals of both coils should face directly toward the front and rear of the chassis and parallel to the sides. Either terminal may be toward the rear.

- ( ) Mount the 1.5-3.0 mh coil #40-67 (this is the coil not completely enclosed by an external core) in the 5/16" hole nearest the top of the chassis and terminal strip A. See Figure 2.
- ( ) Connect a .005  $\mu\text{fd}$  disc ceramic capacitor from A2 (NS) to coil terminal 2 (S).
- ( ) Connect a .005  $\mu\text{fd}$  capacitor from A2 (NS) to A3 (NS). See Pictorial 1 and keep the capacitor close to the terminal strip to allow room for the two mica capacitors.
- ( ) Connect a .005  $\mu\text{fd}$  capacitor from A1 (NS) to terminal 1 of the coil (NS).
- ( ) Connect a wire to A1 (S). Leave the wire long enough to reach pin 1 of the tube socket (about 2 1/2"). Strip the end but do not connect yet.
- ( ) Cut a wire to 3 3/4", strip both ends and connect one end to terminal 1 of the coil (NS). Leave the other end free.
- ( ) Cut one lead of a .005  $\mu\text{fd}$  capacitor to 1/2" and connect to terminal 1 of the coil (S).
- ( ) Slip a 1 1/8" length of sleeving over the other lead and connect to A4 (NS).
- ( ) Connect a 10 K $\Omega$  resistor (brown-black-orange) from A3 (NS) to B1 (NS).
- ( ) Mount the 120-150  $\mu\text{h}$  Q multiplier coil in the 5/16" hole between the tube socket and chassis rear, arranging the lugs as referred to in the note above.
- ( ) Slip a bare wire through the #1 coil terminal (NS) and connect to the lower tuning capacitor terminal (S). See Pictorial 1.



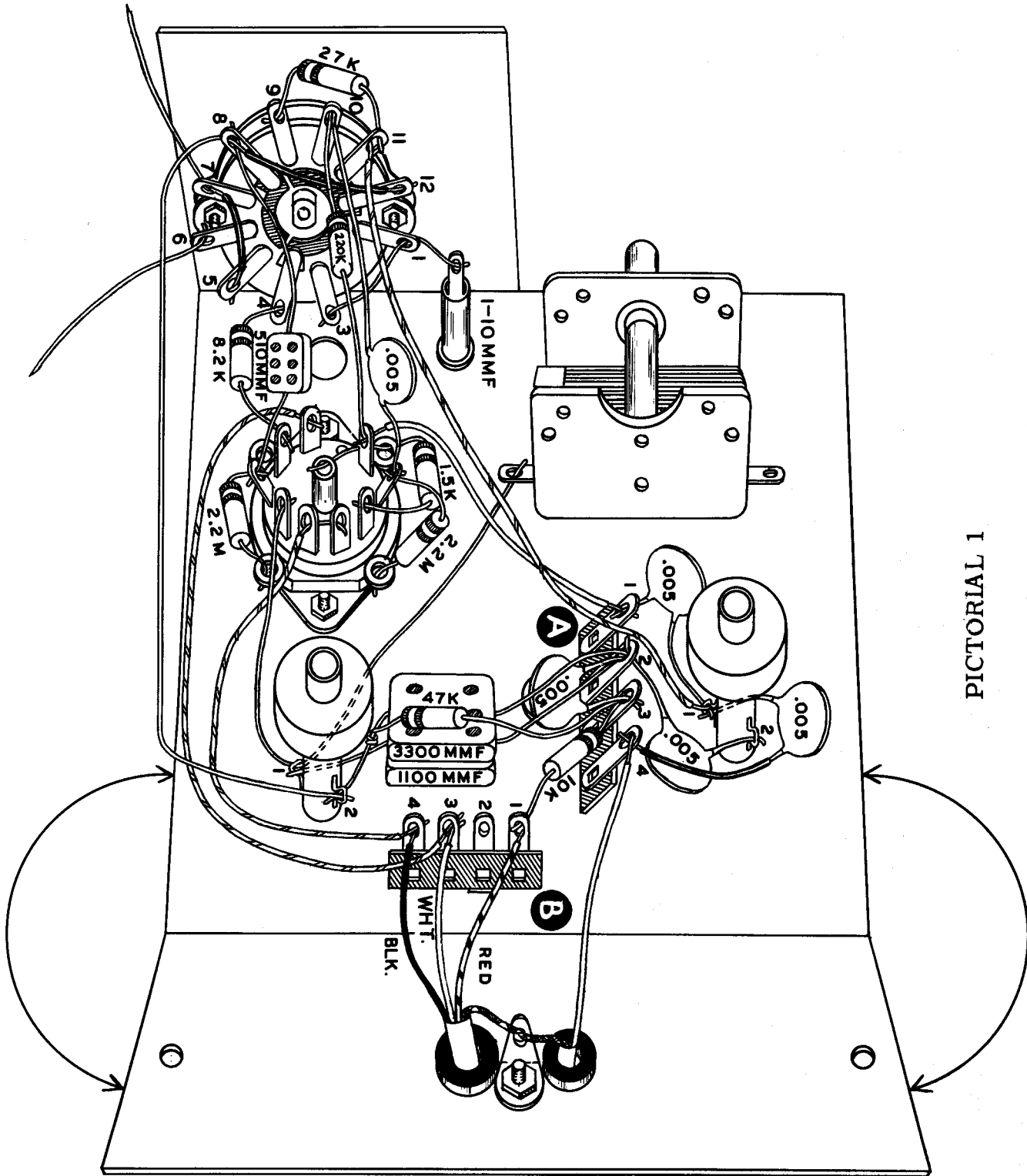

PICTORIAL 1

( ) Arrange the wire to clear all other components. Now bring the remaining end of the wire over to pin 6 of the tube socket (S). Do not solder the coil terminal.

( ) Connect the wire coming from A1 to pin 1 of the tube socket (NS).

**NOTE:** The next two steps are wired for 6 volt operation. In the event 12 volt operation is desired, the two wires are connected to pins 4 and 5 and pin 9 is left open.

( ) Connect a wire from pin 9 of the tube socket (S) to B3 (NS). Place wire as shown.

( ) Connect a wire through pin 5 to pin 4 of the tube socket. Solder both terminals.

( ) Connect the other end of this wire to B4 (NS).

**NOTE:** In mounting the 1100 and 3300  $\mu\mu\text{f}$  mica capacitors, particular care must be taken to prevent damage to the coil terminals. The capacitor leads are quite heavy and can cause undue strain on the coil terminals unless properly shaped before mounting. Figure 3 shows how the capacitors lie in the chassis and the lead arrangement.

Figure 3

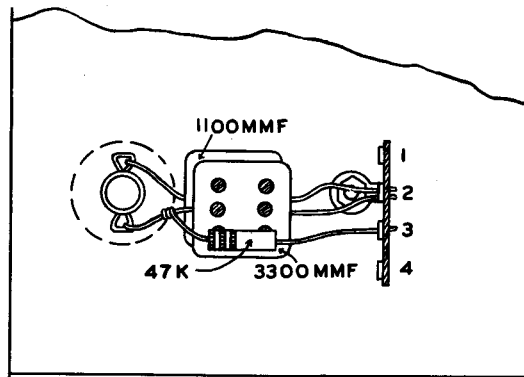

( ) Shape and fit the leads of the 1100  $\mu\mu\text{f}$  silver mica capacitor (brown-brown-red) to allow the capacitor to lie in line between A2 and the coil and flat against the chassis. One lead of the capacitor connects to A2 (NS) and the other lead to coil terminal 1 (S). Do not attempt to wrap the capacitor lead around the coil terminal.

( ) Shape and fit the leads of the 3300  $\mu\mu\text{f}$  silver mica capacitor (orange-orange-red) so that it will lie squarely on top of the 1100  $\mu\mu\text{f}$  capacitor. Before mounting the capacitor, connect one lead of a 47 K $\Omega$  resistor (yellow-violet-orange) to the capacitor lead going to coil terminal 2. Make the connection close to the capacitor body and solder. See Pictorial 1 and Figure 3.

( ) Now mount the 3300  $\mu\mu\text{f}$  capacitor with the combination resistor-capacitor lead connected to coil terminal 2 (NS). Do not crimp.

( ) Connect the other capacitor lead to A2 (S).

( ) Connect the free end of the 47 K $\Omega$  resistor to A3 (S).

**SWITCH WIRING:** To facilitate construction, part of the switch is wired before the switch is mounted. See Figure 4.

( ) Insert a bare tinned wire through switch terminal 8, slide a 1" length of sleeving over the wire as it comes through and connect this end to terminal 12. Solder terminal 12 only. Leave 3 3/8" of wire extending past terminal 8.

( ) Cut both leads of a 27 K $\Omega$  resistor (red-violet-orange) to 1/2". Connect one lead to terminal 9 (S) and the other lead to terminal 11 (NS).

( ) Insert a bare wire through terminal 7, slide a 7/8" length of sleeving over this end and connect to terminal 5. Arrange the lead to clear the switch post. Solder terminals 5 and 7 and leave 1 3/4" of bare wire extending past terminal 7.

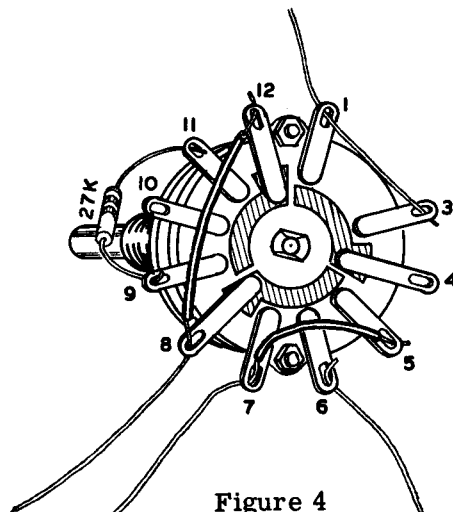

Figure 4

- ( ) Connect one end of a bare wire 2" long to terminal 6 (S). Leave the other end free.
- ( ) Insert a bare wire through terminal 1 to terminal 3. Solder both connections and leave 5/8" of wire extending past terminal 1.
- ( ) Mount the switch on the chassis with the terminals positioned as shown in Pictorial 1, using a 3/8" lockwasher behind the chassis and a flat washer and nut on the front. Do not tighten unnecessarily, as the nut must be removed when the panel and chassis are assembled.
- ( ) Connect the short bare wire from switch terminal 1 to the stator terminal of the 1-10  $\mu\mu\text{f}$  trimmer capacitor (S). Cut off any excess wire.
- ( ) Connect the wire coming from terminal 1 of the 1.5-3 mh coil to terminal 11 of the switch (S).
- ( ) Connect a 220 K $\Omega$  resistor (red-red-yellow) from pin 1 of the tube socket (S) to terminal 10 of the switch (NS).
- ( ) Cut one lead of a .005  $\mu\text{fd}$  disc ceramic capacitor to 3/8" and connect to pin 2 of the tube socket (S). Be sure no shorts occur at this point.
- ( ) Connect the other lead to terminal 10 of the switch (S).
- ( ) Form the bare wire from terminal 6 of the switch so that it will pass through the adjacent hole in the chassis. See Figure 6 on Page 10.
- ( ) Cut both leads of an 8.2 K $\Omega$  resistor (grey-red-red) to 1/2" and bend at right angles close to the resistor body.
- ( ) Connect one lead of the resistor to pin 8 of the tube socket (S) and the other lead to terminal 4 of the switch (S).
- ( ) Form the bare wire coming from terminal 8 of the switch as shown in Pictorial 1 and connect to terminal 2 of the 120-150  $\mu\text{h}$  coil (S). Do not allow this wire to extend below the chassis edge at any point.
- ( ) Connect a 510  $\mu\mu\text{f}$  silver mica capacitor (green-brown-brown) from pin 7 of the tube socket (S) to terminal 8 of the switch (S).
- ( ) Remove the outer covering at one end of the 3-wire shielded cable for a distance of 1 1/2". Comb out the shield braid to this point and retwist tightly to form the ground lead.
- ( ) Leave the black wire full length. Cut the white wire to 1 1/4" and the red and shield wires to 1". Strip the wires for a distance of 5/16".
- ( ) Insert the prepared end of the cable through the 5/16" rubber grommet in the chassis rear, turning the twisted shield braid toward the adjacent solder lug.
- ( ) Make a short direct connection of the shield braid to the solder lug so that cable strain will be absorbed at this point (NS). Cut off any excess lead not necessary for a firm connection.
- ( ) Connect the red lead to B1 (S).
- ( ) Connect the white lead to B3 (S).
- ( ) Connect the black lead to B4 (S).

- ( ) On the coaxial cable, remove the outer covering for 1", then comb out and twist the shield braid. Strip the inner conductor for 5/16".
- ( ) Insert this cable through the 5/16" grommet and make a direct connection of the shield braid to the adjacent solder lug (S).
- ( ) Connect the inner conductor to A4 (S).

NOTE: The connections to be made at the remaining ends of these cables depend on the receiver used and will be explained later under CONNECTION TO THE RECEIVER.

### PANEL PREPARATION

Figure 6

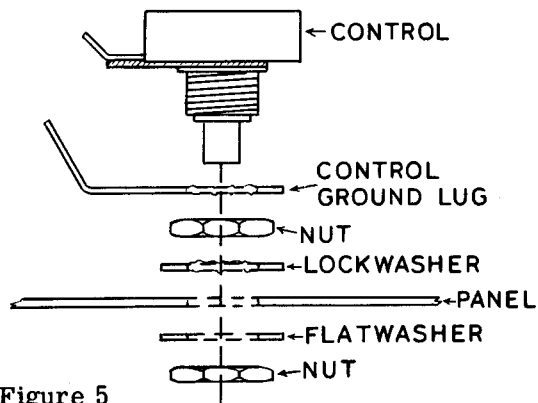
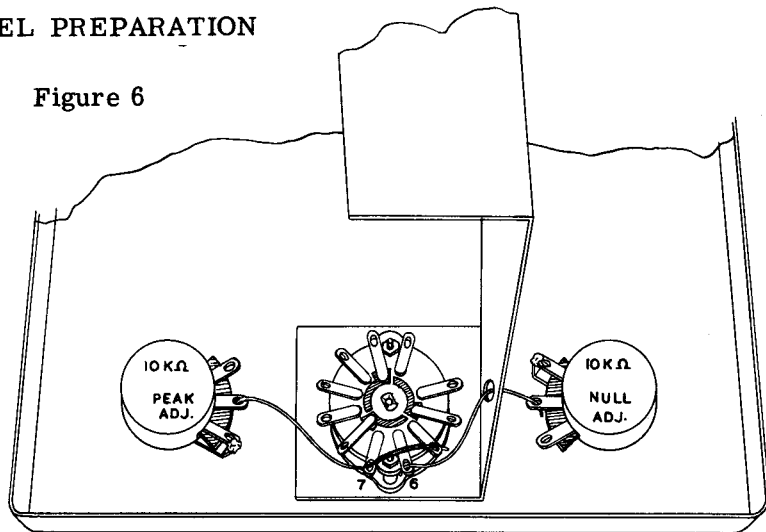

Figure 5

NOTE: One terminal of each 10 K $\Omega$  control is grounded by means of a special solder lug. However, the solder lug must be modified in the following manner for best results. First, straighten the solder lug, then rebend at a point 7/8" from the end, to approximately the original shape. Now cut 3/8" from the end.

- ( ) On each control, mount a ground lug, using a 3/8" nut. Position the lugs as shown in Figure 6 and solder. You will note that this is the same terminal of each control although they appear opposite in Figure 6. This is due to the controls facing each other.
- ( ) Mount the two 10 K $\Omega$  controls to the panel, using lockwashers, flatwashers and nuts. See Figure 5. Position the controls as shown in Figure 6.
- ( ) Now remove the nut and flatwasher from the switch and mount the chassis to the panel using the switch bushing to secure them. Center the tuning capacitor shaft in the 3/4" panel hole and tighten securely.
- ( ) Connect the bare wire coming through the chassis hole from switch terminal 6 to the center tap of the adjacent control (S). Be sure the wire is centered in the hole and is not grounded.
- ( ) Connect the bare wire from terminal 7 to the center tap of the other control (S).
- ( ) Insert 8-32 set screws in the four knobs and the pointer assembly.
- ( ) You will note the tuning capacitor is made with two 1/4" concentric shafts. Slide the pointer assembly with the bushing first, over the shafts until it rides on the shaft closest to the capacitor frame. The pointer should be about 1/32" from the panel.
- ( ) Rotate the tuning capacitor to its mid-point, then align the pointer to the mid-point on the scale and tighten the set screw.

- ( ) Place a small pointer knob over the outer shaft of the tuning capacitor. Align the white index with the pointer and tighten the set screw. Be sure the knob and pointer do not bind together.
- ( ) Turn the switch shaft counterclockwise and install the other pointer knob with the index at the OFF position.
- ( ) Install the two round knobs on the peak and null adjust controls. No positioning is necessary here.
- ( ) Insert the 12AX7 tube in the 9-pin socket.

This completes the assembly and wiring of the Q multiplier.

### CONNECTION TO THE RECEIVER

The QF-1 derives its power from the receiver it is used with, so some provision must be made for this supply. There is no way for the Heath Company to anticipate what type of receiver will be used with the QF-1. However, an octal socket and plug are furnished to aid in making the power connection. Some receivers are furnished with an auxiliary power socket which is usually of the octal type. If this is true in your case, check the receiver schematic to ascertain which contacts provide plate, filament and ground connection and wire the QF-1 3-wire cable to the octal plug in accordance with these. If the receiver has no power outlet, you may mount the octal socket furnished on the receiver and make the appropriate internal connections for power. The 3-wire cable may be wired directly into the receiver, however the former arrangement is more convenient. By the same token, a phono plug and jack are furnished to connect the coaxial cable to the receiver IF stage.

In connecting the 3-wire power cable, the outside shield braid goes to ground, the red wire to B+ 150-300 volts, and the white and black wires to the filament connections. If the receiver has one side of the filament circuit grounded, either the white or black wire should also be grounded.

In regard to the coaxial cable connection, the outside shield is connected to ground and the inner conductor connected to either the plate side of the input IF transformer or the plate connection of the mixer tube at the socket. This connection should be as short as possible and isolated from other receiver circuits. If the phono jack is mounted on the rear of the receiver, be sure to mount it at a point close to the mixer plate circuit. Shielded lead may be used to connect the phono jack to the IF circuit, in which case the first IF primary should be retuned to compensate for the short shielded lead. Do this before the QF-1 is attached to the receiver.

### ALIGNMENT

For best results, the receiver IF strip should be in good alignment at 455 kc. It would pay to check the receiver alignment before proceeding.

With the receiver on and the QF-1 properly connected, turn the QF-1 to the OFF position and tune in a steady phone signal, a broadcast station will do. Rock the receiver tuning until you are sure the signal is centered in the IF bandpass. This may be noted as greatest S meter reading or maximum audio signal. When this condition prevails, tune the coil #40-67 near the top of the QF-1 chassis for the highest S meter reading or maximum audio. Refer to Figure 7 on Page 12. This adjustment tunes out the reactance of the coaxial cable and will not have to be changed again.

Now center the tuning dial to center position on the panel scale. Set the NULL ADJ. knob to approximately mid-position and the function switch to NULL. Adjust coil #40-68 near the chassis bottom for lowest S meter position or an audible garbling of speech due to removal of the carrier. Adjust the NULL ADJ. for greatest effect in this direction and readjust coil #40-68. Repeat until maximum effect is achieved.

Now switch to SHARP PEAK position and adjust the PEAK ADJ. control to just below the point of oscillation without changing the TUNING. Adjust the trimmer capacitor near the center-front of the chassis for greatest S meter reading or an audible narrowing of the signal evidenced by reduced "high" received. This adjustment brings the PEAK and NULL points at the same spot on the tuning dial. Before installing the QF-1 in the cabinet, experiment with other stations or signals on different frequencies, both as a preliminary familiarization and as a double check on the Q multiplier alignment.

Install rubber feet in the four 1/4" cabinet holes and slide the QF-1 into the cabinet with the cords passing through the large hole in the rear. Secure the instrument to the cabinet with two #6 sheet metal screws through the rear cabinet holes.

### OPERATION

As the external core type of coils used with the QF-1 provide their own shielding, the previous alignment will not be affected by the cabinet. Consequently, after reconnecting the QF-1 to the receiver, it is ready for operation.

**OFF position:** In this position, the QF-1 has no effect upon the receiver and it will operate in the usual manner.

**SHARP PEAK:** By varying the PEAK ADJ. control, the receiver selectivity can be changed from broad to extremely sharp. With the control counterclockwise, the bandpass will be quite broad and the receiver gain somewhat decreased. As the control is rotated clockwise, the peak becomes narrower and the gain higher until the sharpest point is reached at just below the point of oscillation.

*change to lower is sharp*  
 With the Q multiplier peaked, the tuning may be varied to accentuate any signal within the receiver IF bandpass and attenuate all others. This is the main advantage the Q multiplier has over a crystal filter. As the receiver does not have to be tuned to peak any particular signal within its bandpass, there is little danger in losing the desired signal.

*code*  
**NULL:** The NULL position is particularly good for removing hetrodynes on phone signals or adjacent CW signals. It is extremely sharp and as such, is very critical to tune. It probably will require a great deal of practice before this function of the Q multiplier can be used to advantage. Besides nulling the interfering signal, it is equally easy to remove the desired signal. Until you become proficient in the operation of the QF-1, the latter effect probably will occur most often.

It may help to remember that the QF-1 tunes toward the high end of the IF bandpass in a clockwise direction, providing the receiver local oscillator is higher in frequency than the incoming signal. Based upon the above premise, a hetrodyne higher in frequency than the desired signal would be removed by approaching it in a counterclockwise direction and vice versa. When the undesired signal has been placed in the notch, adjust both the tuning and null adjust controls for maximum null.

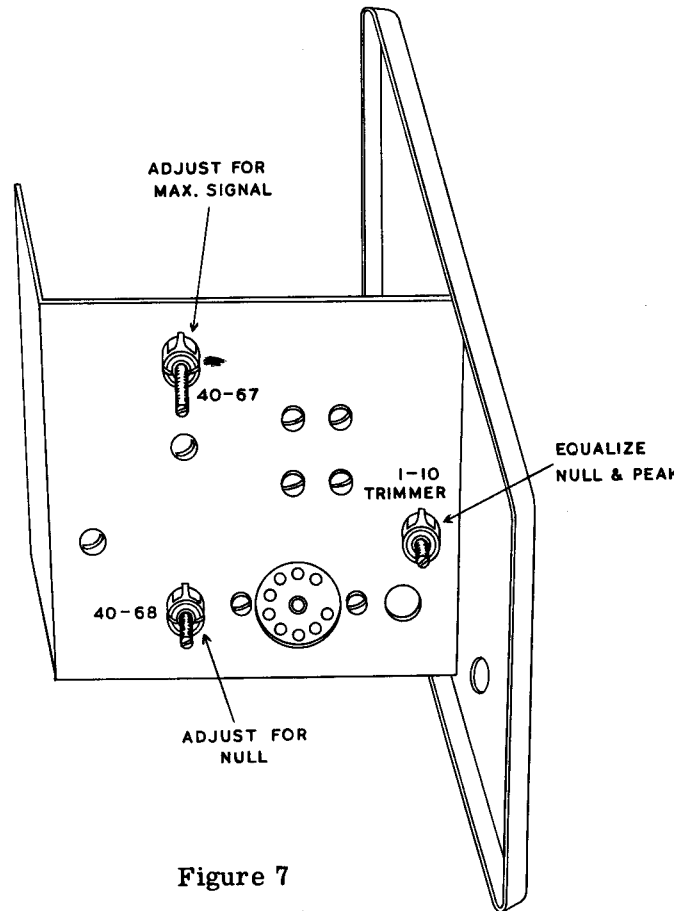

Figure 7

*by tuning control*  
*perfect*  
*When you see...*

**BROAD PEAK:** This position allows a higher gain than the **SHARP PEAK** when a wider bandpass is desired. It also allows the Q multiplier to be used as a BFO by advancing the peak adjust control to just past the oscillation point.

#### IN CASE OF DIFFICULTY

Mistakes in wiring or poorly soldered connections are the most common cause of difficulty. Consequently, the first step is to recheck all wiring against the pictorial and schematic diagram. Often having a friend check the wiring will locate an error consistently overlooked.

With miniature sockets, there is a possibility of shorts between adjacent socket terminals due to the close spacing. This should be checked and if any doubt exists, the terminals should be pried apart until obvious spacing can be seen between them.

There is also the possibility of the coils being open, caused by damage to the wire at the terminals. This may be checked with an ohmmeter **WITH ALL VOLTAGES OFF**. Resistors may have been damaged due to excess heat. These also may be checked with an ohmmeter.

Check the tuning capacitor to see that the plates do not short in any position.

	Pin 1	Pin 2	Pin 3	Pin 4	Pin 5	Pin 6	Pin 7	Pin 8	Pin 9
PEAK	0	0	0	6.3AC	6.3AC	240	0	2.7	0
NULL	100+	-1	.7	6.3AC	6.3AC	210	0	2.5	0

Typical tube socket voltage readings taken with a vacuum tube voltmeter and using a 250 volt supply with one side of the filament grounded.

#### REPLACEMENTS

Material supplied with Heathkits has been carefully selected to meet design requirements and ordinarily will fulfill its function without difficulty. Occasionally improper instrument operation can be traced to a faulty tube or component. Should inspection reveal the necessity for replacement, write to the Heath Company and supply all of the following information:

- A. Thoroughly identify the part in question by using the part number and description found in the manual parts list.
- B. Identify the type and model number of kit in which it is used.
- C. Mention the order number and date of purchase.
- D. Describe the nature of defect or reason for requesting replacement.

The Heath Company will promptly supply the necessary replacement. Please do not return the original component until specifically requested to do so. Do not dismantle the component in question as this will void the guarantee. If tubes are to be returned, pack them carefully to prevent breakage in shipment as broken tubes are not eligible for replacement. This replacement policy does not cover the free replacement of parts that may have been broken or damaged through carelessness on the part of the kit builder.

#### SERVICE

In event continued operational difficulties of the completed instrument are experienced, the facilities of the Heath Company Service Department are at your disposal. Your instrument may be returned for inspection and repair for a service charge of \$3.00 plus the cost of any additional material that may be required. **THIS SERVICE POLICY APPLIES ONLY TO COMPLETED INSTRUMENTS CONSTRUCTED IN ACCORDANCE WITH THE INSTRUCTIONS AS STATED IN THE MANUAL.** Instruments that are not entirely completed or instruments that are modified in design will not be accepted for repair. Instruments showing evidence of acid core solder or paste fluxes will be returned not repaired.



The Heath Company is willing to offer its full cooperation to assist you in obtaining the specified performance level in your instrument. Factory repair service is available for a period of one year from the date of purchase or you may contact the Engineering Consultation Department by mail. For information regarding possible modification of existing kits, it is suggested that you refer to any one or more of the many publications that are available on all phases of electronics. They can be obtained at or through your local library, as well as at any electronic outlet store. Although the Heath Company sincerely welcomes all comments and suggestions, it would be impossible to design, test, evaluate and assume responsibility for proposed circuit changes for specific purposes. Therefore, such modifications must be made at the discretion of the kit builder according to information which will be much more readily available from some local source.

#### SHIPPING INSTRUCTIONS

Before returning a unit for service, be sure that all parts are securely mounted. Attach a tag to the instrument giving name, address and trouble experienced. Pack in a rugged container, preferably wood, using at least three inches of shredded newspaper or excelsior on all sides. **DO NOT SHIP IN THE ORIGINAL KIT CARTON AS THIS CARTON IS NOT CONSIDERED ADEQUATE FOR SAFE SHIPMENT OF THE COMPLETED INSTRUMENT.** Ship by prepaid express if possible. Return shipment will be made by express collect. Note that a carrier cannot be held liable for damage in transit if packing, in HIS OPINION, is insufficient.

#### SPECIFICATIONS

All prices are subject to change without notice. The Heath Company reserves the right to discontinue instruments and to change specifications at any time without incurring any obligation to incorporate new features in instruments previously sold.

#### WARRANTY

The Heath Company limits its warranty of parts supplied with any kit to a period of three (3) months from the date of purchase. Replacement will be made only when said part is returned postpaid, with prior permission and in the judgment of the Heath Company was defective at the time of sale. This warranty does not extend to any Heathkits which have been subjected to misuse, neglect, accident and improper installation or applications. Material supplied with a kit shall not be considered as defective, even though not in exact accordance with specifications, if it substantially fulfills performance requirements. This warranty is not transferable and applies only to the original purchaser. This warranty is in lieu of all other warranties and the Heath Company neither assumes nor authorizes any other person to assume for them any other liability in connection with the sale of Heathkits.

The assembler is urged to follow the instructions exactly as provided. The Heath Company assumes no responsibility or liability for any damages or injuries sustained in the assembly of the device or in the operation of the completed instrument.

HEATH COMPANY  
Benton Harbor, Michigan

<u>PART No.</u>	<u>PARTS Per Kit</u>	<u>DESCRIPTION</u>	<u>PART No.</u>	<u>PARTS Per Kit</u>	<u>DESCRIPTION</u>
<b>Resistors</b>			<b>Hardware</b>		
1-11	1	1.5 K $\Omega$ 1/2 watt	73-4	2	5/16" rubber grommet
1-20	1	10 K $\Omega$ 1/2 watt	250-4	4	4-40 x 3/8 RH machine screw
1-23	1	27 K $\Omega$ 1/2 watt	250-8	2	#6 sheet metal screw
1-25	1	47 K $\Omega$ 1/2 watt	250-31	3	6-32 x 1/4 RH machine screw
1-29	1	220 K $\Omega$ 1/2 watt	250-43	1	8-32 x 1/4 set screw
1-37	2	2.2 megohm 1/2 watt	250-49	2	3-48 x 1/4 BH machine screw
1-73	1	8.2 K $\Omega$ 1/2 watt	252-1	2	3-48 nut
			252-3	3	6-32 nut
			252-7	5	Control nut
<b>Capacitors-Coils</b>			253-10	3	3/8" flat washer
20-42	1	510 $\mu\mu\text{f}$ silver mica 5%	254-1	2	#6 lockwasher
20-53	1	1100 $\mu\mu\text{f}$ silver mica 2%	254-4	3	3/8" lockwasher
20-54	1	3300 $\mu\mu\text{f}$ silver mica 5%	254-7	2	#3 lockwasher
21-27	5	.005 $\mu\text{fd}$ disc ceramic	255-2	4	#6 x 3/16" spacer
26-28	1	100 $\mu\mu\text{f}$ variable	259-1	1	#6 solder lug
31-8	1	1-10 $\mu\mu\text{f}$ trimmer	259-10	2	Control solder lug
40-67	1	1.5-3.0 mh coil	261-1	4	Rubber feet
40-68	1	120-150 $\mu\text{h}$ coil			
<b>Controls-Switches-Tubes</b>			<b>Miscellaneous</b>		
10-31	2	10 K $\Omega$ linear control	90-39	1	Cabinet
63-106	1	3-pole 4-pos. rotary switch	100-M74	1	Pointer assembly
411-26	1	12AX7 tube	200-M91	1	Chassis
<b>Sockets-Terminal Strips-Knobs</b>			203-79F109-111	1	Panel
431-12	2	4-lug terminal strip			length #20 tinned wire
434-31	1	Octal wafer socket	340-2	1	length Coaxial cable
434-42	1	Phono jack	343-2	1	length Hookup wire
434-56	1	9-pin miniature socket	344-1	1	length 1/8" sleeving
438-4	1	Phono plug	346-1	1	length 3-wire shielded cable
438-6	1	Octal plug	347-9	1	Instruction manual
440-1	1	Octal plug cap	595-113	1	
462-18	2	Round knob			
462-19	2	Pointer knob, small			

## HELPFUL KIT BUILDING INFORMATION

Before attempting actual kit construction read the construction manual through thoroughly to familiarize yourself with the general procedure. Note the relative location of pictorials and pictorial inserts in respect to the progress of the assembly procedure outlined.

This information is offered primarily for the convenience of novice kit builders and will be of definite assistance to those lacking thorough knowledge of good construction practices. Even the advanced electronics enthusiast may benefit by a brief review of this material before proceeding with kit construction. In the majority of cases, failure to observe basic instruction fundamentals is responsible for inability to obtain desired level of performance.

### RECOMMENDED TOOLS

The successful construction of Heathkits does not require the use of specialized equipment and only basic tools are required. A good quality electric soldering iron is essential. The preferred size would be a 100 watt iron with a small tip. The use of long nose pliers and diagonal or side cutting pliers is recommended. A small screw driver will prove adequate and several additional assorted screw drivers will be helpful. Be sure to obtain a good supply of rosin core type radio solder. Never use separate fluxes, paste or acid solder in electronic work.

### ASSEMBLY

In the actual mechanical assembly of components to the chassis and panel, it is important that the procedure shown in the manual be carefully followed. Make sure that tube sockets are properly mounted in respect to keyway or pin numbering location. The same applies to transformer mountings so that the correct transformer color coded wires will be available at the proper chassis opening.

Make it a standard practice to use lock washers under all 6-32 and 8-32 nuts. The only exception being in the use of solder lugs—the necessary locking feature is already incorporated in the design of the solder lugs. A control lock washer should always be used between the control and the chassis to prevent undesirable rotation in the panel. To improve instrument appearance and to prevent possible panel marring use a control flat nickel washer under each control nut.

When installing binding posts that require the use of fiber insulating washers, it is good practice to slip the shoulder washer over the binding post mounting stud before installing the mounting stud in the panel hole provided. Next, install a flat fiber washer and a solder lug under the mounting nut. Be sure that the shoulder washer is properly centered in the panel to prevent possible shorting of the binding post.

### WIRING

When following wiring procedure make the leads as short and direct as possible. In filament wiring requiring the use of a twisted pair of wires allow sufficient slack in the wiring that will permit the twisted pair to be pushed against the chassis as closely as possible thereby affording relative isolation from adjacent parts and wiring.



































When removing insulation from the end of hookup wire, it is seldom necessary to expose more than a quarter inch of the wire. Excessive insulation removal may cause a short circuit condition in respect to nearby wiring or terminals. In some instances, transformer leads of solid copper will have a brown baked enamel coating. After the transformer leads have been trimmed to a suitable length, it is necessary to scrape the enamel coating in order to expose the bright copper wire before making a terminal or soldered connection.

In mounting parts such as resistors or condensers, trim off all excess lead lengths so that the parts may be installed in a direct point-to-point manner. When necessary use spaghetti or insulated sleeving over exposed wires that might short to nearby wiring.

It is urgently recommended that the wiring dress and parts layout as shown in the construction manual be faithfully followed. In every instance, the desirability of this arrangement was carefully determined through the construction of a series of laboratory models.

### SOLDERING

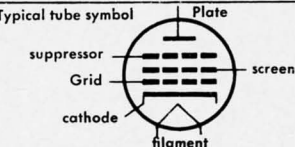
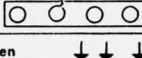
Much of the performance of the kit instrument, particularly in respect to accuracy and stability, depends upon the degree of workmanship used in making soldered connections. Proper soldered connections are not at all difficult to make but it would be advisable to observe a few precautions. First of all before a connection is to be soldered, the connection itself should be clean and mechanically strong. Do not depend on solder alone to hold a connection together. The tip of the soldering iron should be bright, clean and free of excess solder. Use enough heat to thoroughly flow the solder smoothly into the joint. Avoid excessive use of solder and do not allow a flux flooding condition to occur which could conceivably cause a leakage path between adjacent terminals on switch assemblies and tube sockets. This is particularly important in instruments such as the VTVM, oscilloscope and generator kits. Excessive heat will also burn or damage the insulating material used in the manufacture of switch assemblies. Be sure to use only good quality rosin core radio type solder.

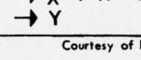
Antenna General 	Resistor General 	Neon Bulb 	Receptacle two-conductor 
Loop 	Resistor Tapped 	Illuminating Lamp 	Battery 
Ground 	Resistor Variable 	Switch Single pole Single throw 	Fuse 
Inductor General 	Potentiometer 	Switch double pole single throw 	Piezoelectric Crystal 
Air core Transformer General 	Thermistor 	Switch Triple pole Double throw 	1000 = <b>K</b>
Adjustable Powdered Iron Core 	Jack two conductor 	Switch Multipoint or Rotary 	1,000,000 = <b>M</b>
Magnetic Core Variable Coupling 	Jack three conductor 	Speaker 	OHM = $\Omega$
Iron Core Transformer 	Wires connected 	Rectifier 	Microfarad = <b>MF</b>
Capacitor General 	Wires Crossing but not connected 	Microphone 	Micro Microfarad = <b>MMF</b>
Capacitor Electrolytic 	A. Ammeter V. Voltmeter 	Typical tube symbol 	Binding post Terminal strip 
Capacitor Variable 	G. Gaivanometer MA. Milliammeter uA. Microammeter, etc. 	Wiring between like letters is understood 	

# **HEATH COMPANY**

*A Subsidiary of Daystrom Inc.*

**THE WORLD'S FINEST ELECTRONIC EQUIPMENT IN KIT FORM**

**BENTON HARBOR, MICHIGAN**