

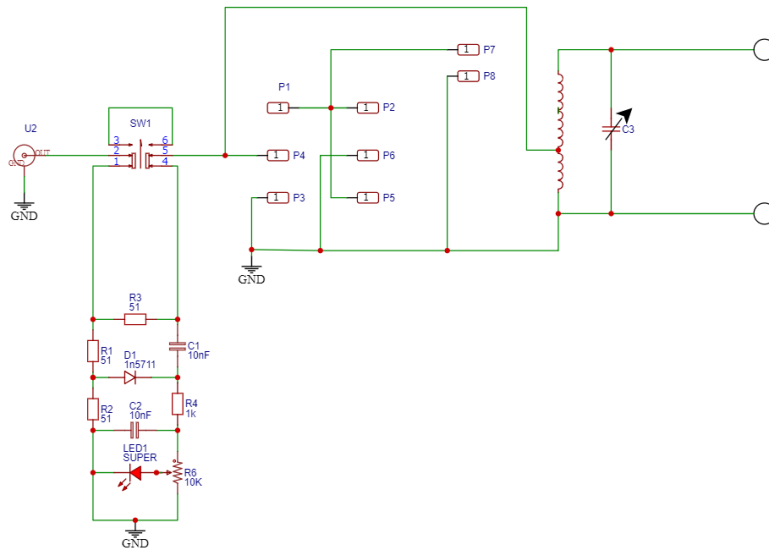

End Fed halfwave 40-15m QRP ATU

You can have the latest all singing all dancing radio with DSP and a fancy LCD screen but its of little use if you don't have a antenna. The antenna is the most important part of the system. If your operating portable it can be hard to quickly setup a antenna, personally I love the good old fashion dipole, its big disavantage is that it needs a way to get the centre up high and then you need to find two supports for the ends. Not that practical is it? So what else can we do? Well possibly the most popular antenna for portable or temporary use is the endfed wire, and the most common must be the endfed half wave. The EFHW has a number of advantages. Just one end needs fixing at a height, when matched, the feed point is at a voltage max with little current so the counterpoise often can be ignored or for best results a short (0.1 - 0.2 wavelength) is all that is needed, often people just use the coax it self as a C.P. The current on the coax will be low as it a high voltage feedpoint. The BIG problem is that the EFHW typically has a feedpoint impedance of thousands of ohms not the 50 ohm's the modern transceiver needs, this device although often called a ATU is really matching the impedance of the antenna to that of the radio. This protects the radios PA and ensures maximum power transfer to (and from) the antenna.



The EFHW uses a resistive SWR bridge with adjustable sensitivity, works well from a few 100mW up to the power limit of the ATU, I recommend keeping the power to QRP levels maybe a little more when matched. Please ignore resistor ref numbers shown on the circuit as they changed on the new PCB.

Specification:-

Power Level :- 5 to 10 watts

Frequency Range 7 to 21Mhz (See notes at the end of this doc)



Note on Suggested antenna sizes:-

Please note, this is **NOT** a random wire tuner, it is designed to be used with a Half Wave length of wire for the band you are interested in, it will match this halfwave in the range of 7 to 21Mhz (40-15m Ham bands)

Although not always necessary a counterpoise can help improve the efficiency, a short counterpoise can be used of approx 1/10th to 1/20th of a wavelength.

It is also advisable to use coax fed of at least 5m, this helps keep RF away from the operator and the equipment.

Band	Ant Length	Counterpoise length (approx 1/10 wavelength)
40m	66ft (20m)	16ft (4m)
30m	46ft 3 inch (15m)	10ft (3m)
20m	33ft 3 inch (10m)	6ft (2m)
17m	25ft 10 inch (8.5m)	6ft (2m)
15m	22ft 2 inch (7.5m)	5ft (1.5m)

The lengths given are not exact as even the type of insulation on the wire will change the length not to mention nearby objects and supports. Also the part of the band you are using will mean the lengths given could need a tweak (figures here are most suitable for the CW end of the bands). I find these lengths will be ok when used with the ATU as it can tune out these small differences.

Parts List

EF-ATU PCB
EFHW Front plate
Case
2 x Terminal Posts (Black /Red)
BNC Socket
1 x DPST Switch
1 x Red 5mm LED
1 x Variable capacitor
2 x 2.5mm x 5mm Cap mounting screws
1 x 2.5mm x 12mm extender shaft screws
1 x 10mm shaft extender
1 x Control knob
3 x 51 ohm 2 Watt resistors (R2, R3, & R4)
1 x 10K trimmer
1 x 1N5711 diode
1 x 1K resistor
2 x 0.01uF capacitors (5.08mm spacing)
1 x 0.01uf capacitor (2.5mm spacing)
T50-6 Core
700mm 25 SWG (0.5mm) enamelled Wire
2 x BNC connecting wire
4 x Stick on Feet
4 x front plate mounting screws



Before you start work on the ATU check you have all the parts listed, any problems contact me
sales@kanga-products.co.uk

The ATU uses a single T50-6 toroidal core which although fairly small is fine for the power levels (and higher) that we are running (QRP).

Warning... Boring Maths follow:-

Some of you who like a bit of maths may like to see how we work out the number of turns and the position of the tap on the coil, that way if you wish you can make changes to the circuit at a later date if you want to change the coverage of the ATU.

First of all we need to understand that the EFHW antenna presents a high impedance at the fed point, typically thousands of ohms, our radios are normally expecting only 50 ohms so we need to transform this high impedance down to a level we can use. Typical people use a 49:1 matching transformer of some kind to bring this very high impedance down to nearer 50 ohms.

That's great and so we can use this in our design for the EFHW ATU.

To work out the turns ratio we need we take the square root of the impedance transfer so Square root of 49 (from the 49:1 transformer) equals 7. We need a ratio of 7:1 in our number of turns.

Ok so now how many turns do we need,

Well what is the lowest frequency we want our ATU to work on? Well I intended it to work over 40-20m meters (but should work over a wider range at the high end, lets try for upto 15m) so that 7 to 21Mhz so a little lower than 7Mhz and a little higher than 21Mhz would be great.

Lowest frequency for the design is 6.5Mhz, we are using a 240pf variable capacitor so that's 6.5Mhz with the cap set to 240pf

From the formula

$$F_R = \frac{1}{2\pi\sqrt{LC}}$$

with F =6.5Mhz and C=240pf we rearrange it and that gives us
2.5uH as the inductance

Now if we use this value and put that back into the same formula but this time with F=22Mhz and working out the capacitance we would get

$$F=22Mhz \quad L=2.5uH \quad \text{so } C= 21pf \text{ min cap}$$

So it would seem that a 2.5uH inductor with our 240pf variable capacitor will allow us to tune the range we want.

So how many turns is that?

We are using a T50-6 and the data sheets for it tell us a few useful things, the calculation we need to look at is

$$\mu H = AL \times (\text{Number of turns})^2 / 1000$$

with a T50-6 AL=4 so.....



We know the inductance we need, so if we calculate the turns we get

$(2.5\mu\text{H} * 1000) / 4 = (\text{Number of turns})^2$ which works out to 25 turns in total

With 0.5mm or similar wire we can get 25 turns on the T50 core.

So what about the tap to give us the 49:1 impedance transformation?

So we know that the 49:1 impedance transformation is a 7:1 turns ratio,

Divide 25/8 gives us just over 3. So if we set our tap point to 3 turns and then have an extra 22 turns after the tap we get what we need.

This is how I have worked out the windings on the toroidal.

Hope some of you found that interesting and those that didn't can wake up now.

Winding the Core.

Some people fear winding toroidal cores, don't worry this one is fairly easy to do if you just take your time and follow the steps below. You would be surprised how many times people tell me about problems with kits. When I look into it or they send me a photo of the 'problem' it's normally that they have done their own thing and not read or followed the instructions. Please save us both problems and follow the instructions for this core.

A recap, we need a total of 25 turns on the core, every time the wire passes through the core it counts as a turn. We need a tap at one end 3 turns into the winding and then an additional 22 turns.

Start with finding and straightening out the wire for the core, it's about 700mm long. This wire has a special enamel coating that can be burned off by soldering but more on that later.

The core you need is yellow and in likelihood will have one side grey

Many people find winding toroidal cores strikes fear into them, really they are easy to do. The one here should be well within the scope of anyone that takes care and can follow the instructions.

The core needs to be wound with the 700mm length of wire supplied with the kit. It comprises of a total of 25 turns with a tap between the 3rd and 4th turn from the earth side.

I hope the pictures below helps. If you can look on the Kanga Products web site for colour pictures of this which will make things clear.

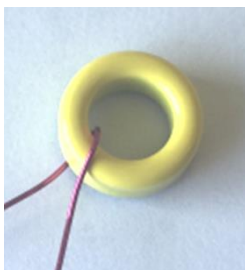

Start with passing the wire through the core as shown. Now wind 3 turns around the core, each time the wire passes through the core it counts as a turn. The short end of the wire should be down at 6 O'clock position as we start winding up towards in the 9 O'clock direction

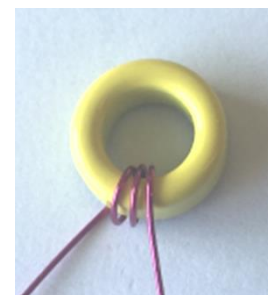

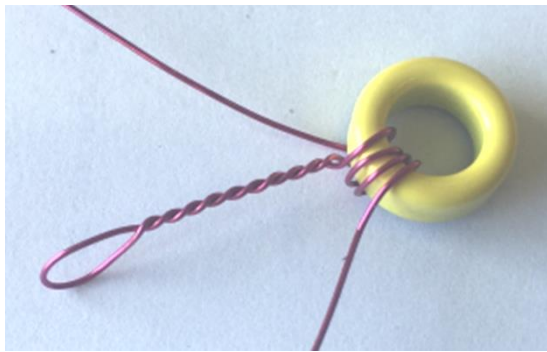

Now we need to form a loop.

Make this loop around 1 inch long.

Not the direction that we are winding the core, it must be wound this way we started at the bottom of the core and are winding clockwise.

Now we continue to wind the core so we have an extra 22 turns after the loop.

When you have finished winding the core double check the number of turns. The best way to do this is to use your mobile phone/camera and take a picture, zoom in and then it should be easier to count the turns on the computer screen.

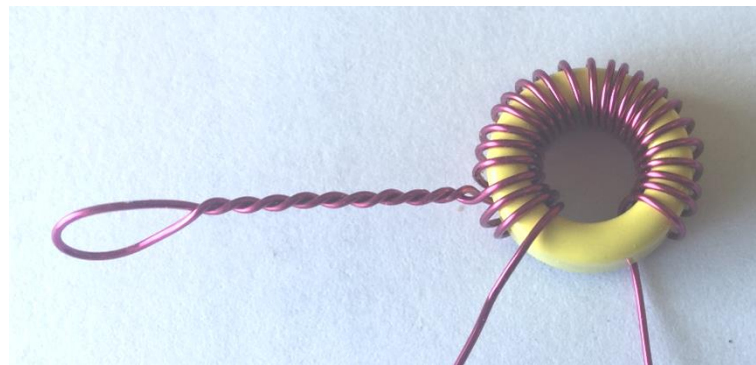

Ok we have done the hard part but

we still have a difficult task to complete with this core. The windings are enamelled covered wire, the enamelling acts like an insulator and would stop any electrical connection to the wire. The wire I have used has a special enamel that will melt when exposed to the heat of molten solder, I find a light scraping of the enamel first will help with this task and even then you need to apply the soldering iron to the wire with a large blob of solder to melt it, you will need to apply the iron for a least 10 secs to the wire while feeding fresh solder to the wire, you will see a little puff of smoke and the solder will tin the wire as the enamel melts,

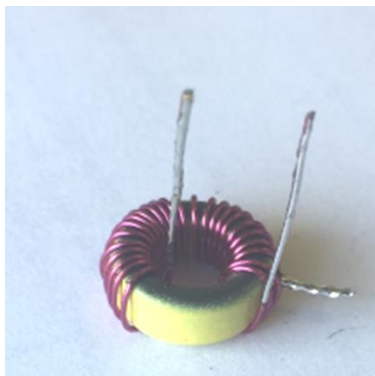

DO NOT breathe in the fumes, I am sure they are not good for you! Look at the picture here to see what you're trying to achieve.

Once tinned you're ready to fit the core to the PCB. Put it on one side and let's start on the PCB.



******* Very Important Note *******

Please make sure you read the instructions below about mounting the extender shaft on the capacitor, it is easy to break the internal stops if you do this wrong .

Lets put the basic PCB together.

The board has parts fitted on both sides and it's important that the right part is on the right side of the board, also the order that you fit the parts is important as some solder pads are under the bodies of other parts.

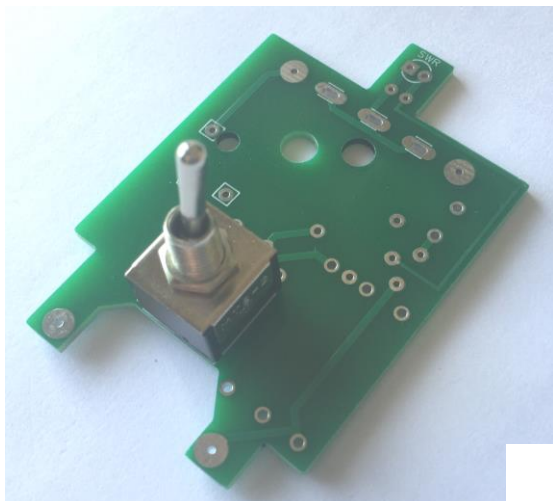

- 1) Fit the switch first, the switch must sit on the side of the PCB that shows the silk screen picture of the switch and you will see 'SWT' near one edge of the board, make sure that you push the pins through the board and that the switch sits straight and flush.

- 2) Now turn the board over and we can fit most of the other parts, I suggest fitting them in this order.

Fit the three 51 ohm 2 watt resistors, these act as part of the tuning indicator bridge and can get hot when you tune the ATU, the total power fed into the ATU will be shared with these three resistors and the antenna while tuning so in a worst case scenario with a short circuit on the output the three will share the full amount of RF power, since we are only using QRP that would be a rated power of 6 Watts but of course we will be only applying power to the tuning bridge for a short time and we hope we will not have a short circuit on the output so these two watt resistors are suitable for our needs. **(Also keep the off cuts for now!)**

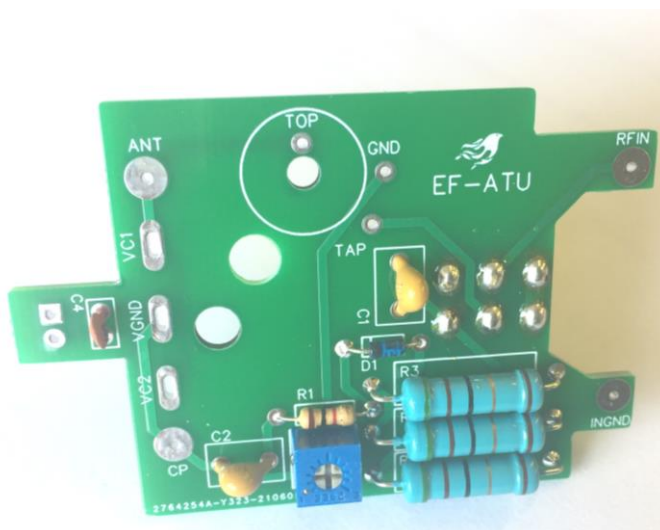

Fit the other small parts C1, C2, C4, R4 and D1. (C3 is the tuning cap so don't worry about that yet) Make sure that D1 is fitted the correct way round (see the silk screen layout on the board to see which end the band on the diode should be).

(C4 is a later addition to the ATU see the notes at the end of these instructions about what it does. Some of the pictures below do not show C4 as its only fitted on the newer revision boards)

Now fit the small trimmer SWR adjust control. (Set this about 1/2 way at this point!)



Now we are going to fit the toroidal coil.

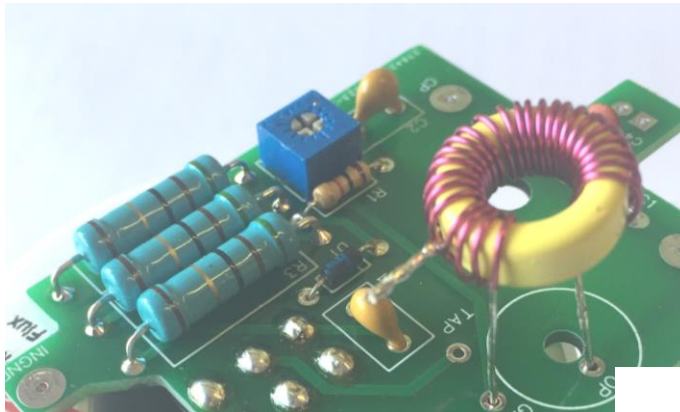

This core as two long ends and a tap.

Position it as shown here and push it flush to the board, do not worry about the tap at the moment we will sort that shortly.

Ok you kept the offcuts from the resistors didn't you? I hope so. Use one of these offcuts to connect the PCB to the coils tap, I make a little walking stick hook on one end that goes over the loop and drop it through through the board and the 'hook' over the tap, solder when done (both at the loop and under the board)



Now I strongly recommend that you use a meter and check for continuity between the ends of the coil. The best place to check this is on the two larger pads marked ANT and CP.

Well done the PCB is just about complete for now.

The next stage is to fit the two terminal posts. Remove the large securing nut from the posts and put the posts through the front plate and the box, make sure the front plate is lined up with the other holes in the box and secure the terminals with their large nuts. This is the second most difficult task, I find a good way is to unscrew the top section of the terminals and not the small round hole in the shaft. I place a thin 'watch makers' type screw drive into the hole to help me hold the post while I use a socket or small spanner to tighten the nuts securing the posts to the box. This can be a little awkward so take your time and make sure when done that the other holes line up ok with the front plate.





Now fit the BNC socket to the case.

BEFORE you fit this I find it easier to attach the wires to the socket and the earth tag. I have supplied two lengths of Silicone coated wire that is very flexible and works well for this. We can cut them to length later so leave

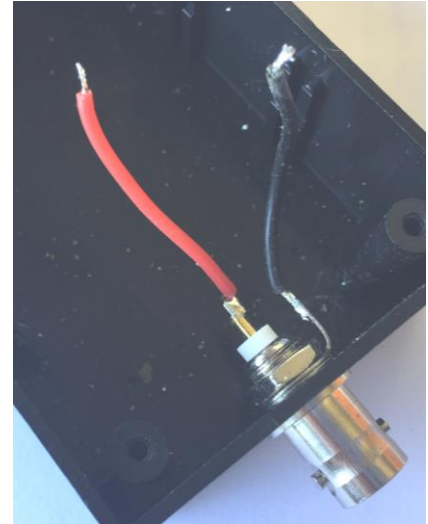

them a little too long for now.

Now the case is pre-drilled for this connector but if you must you could enlarge the hole to allow for a SO239 connector if you wish.

Let's start putting this all together.



Remember the warning earlier about the fitting of the extender!

We have now to fit the capacitor to the front panel. First fit the shaft extender, it's a black 10mm long plastic shaft that is secured by a 2.5mm x 12mm screw, be careful here, you can damage the internals of the capacitor by applying too much direct force. Hold the small brass shaft with a pair of cutters while tightening the screw, this keeps any force off the internal parts.

Now fit the capacitor to the front panel using the two short M2.5mm screws provided. Make sure you fit it as shown. Adjust the two trimmers on the back for minimum capacitance (Fully open)

Now Remove the **TOP** nut and washers from the switch (not the bottom nut) make sure you can turn the bottom nut, these can be tight and it will be hard to loosen it later. Place the LED into the PCB just in front of the switch. Make sure that the long leg of the LED is nearest to the switch (the round hole). **DO NOT Solder it yet!**





Now very carefully lower the top panel onto the PCB so that the 3 leads from the capacitor go into the three slots on the board for them. Double check that all three pins have gone through and none are just folded under the capacitors body. Also make sure the LED goes through the front panel too. (don't forget some of the following photos are of an earlier board with one less capacitor, you board will be slightly different)



Once you're happy make sure the board is sitting flush on top of the capacitor and solder the three leads in place and trim. Turn the board on its side now and look at the switch, you will most probably need to adjust the single nut on the switch to get it to touch the back of the front plate, this should level up the board. I use a small flat blade screw driver to turn the nut, you don't need to make it tight just get it to touch the front plate.

Now solder the two pins of the LED while making sure it's as far forward as it can go.



Now we need to connect to the two 4mm posts.

Use some of those off cuts from the large resistors for this. I solder them to the end of the posts but if you wish you can use the other nuts that came with the posts to secure the wire ends.

Now we need to fit the ATU into its case. We have already fitted the socket and attached wires.

Trim the length of wires so they just fit nicely and solder to the board, the earth tag wire goes to the pad marked GND and the wire from the centre pin goes to the pad marked IN.

Just about done now.

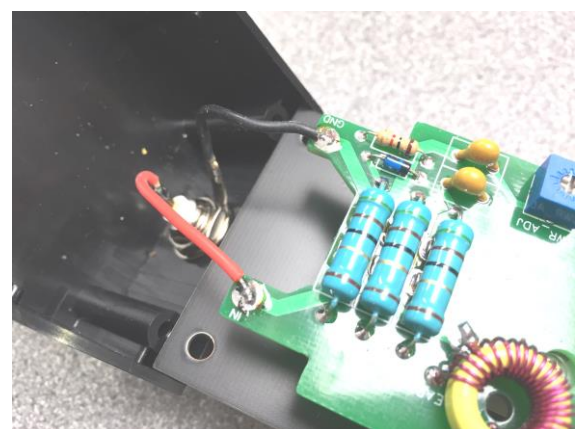



Place the top onto the case and secure with the 4 black self-tapping screws that come with it.



Turn the shaft of the capacitor towards the number 12 on the scale, now fit the supplied knob. The screw should be nearest the number 1 on the scale.

We are now finished and just need to test the ATU.

You must remember that this is HALFWAVE tuner, not a random wire ATU so you should use an antenna wire length to suit the frequency you're interested in, for this example I will be using 20m.

Halfwave for 20m

20m Driven wire 33ft 3 inch (10m) Counterpoise 6ft (2m)

I would recommend that you use at least a 5m long coax cable between the ATU and the radio. That keeps RF away from the radio and keeps things more stable.

Attach the wires, the main antenna to the RED terminal and the short wire to the BLACK terminal, the wire should be straight and in the clear as much as possible.

Now don't transmit yet.

Tune to a 20m frequency and then adjust the ATU while in receive mode. I find a when you find the sweet spot the RX noise will increase a lot. This is a good starting point. Reduce transmitter power to as low as you can and put the ATU in 'Tune' Mode, transmit a solid carrier (Key down or switch to AM/FM if you have no other way to give a solid carrier). Adjust the tuner to find the point the LED goes out, if you have already peaked the tune on RX it may not need much adjustment. Once happy that the LED is as dim as possible stop transmitting and flick to OPER mode. If the LED isn't very bright at any setting you may need to adjust the small blue trimmer to get a good brightness. That's it, now enjoy the QSO's.

While tuning try and keep the tune time low and the power low, when tuned you can increase the power level up to about 10 watts but while tuning try and keep the power to a couple of watts max. As always be careful with RF as you can get burns even at such low power levels. Don't touch the wire!

Tips, if like me you like to see a bright LED while tuning I set the sensitivity control to max,

If you want try removing the counterpoise wire, often people will state that you don't need one with a halfwave and often this can be the case, the antenna uses the coax as a counterpoise then, this can cause so RF feedback issues at the radio end but feel free to give it a go if you wish.



Trouble shooting,

No led lights, try adjusting the sensitivity trimmer inside the ATU, failing that you may have fitted the LED the wrong way. If you have an in line SWR meter try that while tuning to see if the SWR is being adjusted by the ATU. If so it's most likely that you have put the LED in backwards.

LED lights when in OPER mode

The LED is out of circuit when you switch to OPERate mode but... stray RF can still find its way into the LED circuit, that depends on a number of factors. You may find this more on the higher bands. The circuit has been modified to help reduce this effect by the addition of C4 which is across the LED itself. This extra capacitor has no effect on the operation of the ATU but does reduce the stray RF LED illumination. It is still possible that under certain conditions the LED may glow but its not a fault and not something to worry about, consider it a TX lamp if you can see it, if you wish you can remove C4 and this will be more noticeable if you like that idea.

No match 17/15m or 40m

If you find it hard to get a match on certain bands it can be due to not having the correct antenna length, if you're sure that you do then it's possible that the coil could be giving the wrong inductance. Look at the coil and if you are finding it hard to get 17/15m then you have too much inductance, space the windings out a little more on the core can sort this out, if you're having problems not getting 40m then squeeze the turns closer on the core to increase the inductance.

If you have any problems drop me an email.

sales@kanga-products.co.uk

73 Paul MOBMM