



## Kanga QRP Mini Transmatch ATU (MTM-ATU) Full kit

The MTM-ATU uses a well know and effective Transmatch circuit with a resistive bridge SWR LED indicator. The transmatch will work from 3.5MHz to 30MHz, It is suitable for Power levels upto around 10 watts when matched. Works well with SW Receivers too.

The best antenna in my opinion is whatever you can put up in the space you have, after all ANY antenna is better than no antenna. This often is a none resonant length of wire that we want to work on multiply bands. The problem is that such an antenna is likely to be a poor match for our modern transceiver and if we are not careful we can cause damage to our radio. The way to protect the radio is to transfer the power from radio to the antenna. If the antenna is a poor match it's rather like throwing a ball at a wall, most of the power bounces back into the radio causing the PA to run very hot and often we can damage the output stage resulting in big bill for a new output stage.



Now you may think an ATU tunes the antenna allowing it to be used on our chosen frequency but it does not, the ATU is just an impedance matching device that allows better power transfer into the antenna, no ATU can make a bad antenna a good one. Yes you will see an improvement in performance because power is now at least getting into the wire from the PA and so some will radiate, likewise on receive more signal will be transferred into the receiver due to better impedance matching. Depending on the frequency of interest the impedance of the antenna will change from a few ohms to a few thousand ohms. No ATU will tune all antennas on all frequencies or if it does the efficiency will be very low with often little power reaching the antenna itself.

Remember a dummy load will give you a good match but that doesn't make it a good antenna!

In an ideal world we would all use cut to length resonant antennas but we live in the real world and so most of us, especially if we operate portable have to make do with what we have. Therefore a good ATU is a very helpful piece of equipment. With limited power it's important to transfer as much of our power as possible with as little loss as possible.

There are many different ATU types L match being one of the most common but although they all provide matching the efficiency can vary a lot, also most do not provide any additional filtering of the signal so pass multiple harmonics that may be present in the radios output.

Enter the transmatch

Well the transmatch is a more complicated ATU than many other designs but it does have a couple of advantages. The transmatch design provides a Band pass type filter which can really help reduce unwanted out of band interference. From an efficiency point of view the transmatch is also very good, much better that the simple traditional L-Match circuits. I also find that a transmatch of this design are faster to tune as there is no need to switch inductors, just two controls to adjust gives a faster match.



This project will build a very small Transmatch, The smallest desktop mounting unit I have seen.

Let me start by saying I do not take any credit for the design or the principal of the Transmatch ATU. The original work seems to have been done by Charlie Lofgren W6JJZ and over the years many variations have been seen, the Kanga QRP Mini Transmatch combines his work with a well-known resistive SWR bridge to build a very compact unit.

### **Parts List**

Check you have all the parts before we begin building

Transmatch case  
Transmatch Front Panel  
Transmatch PCB  
Rear Panels (BNC or SO239)  
DPST Switch  
SPST switch  
R2, R3, R4 51 Ohm 2 Watt Resistor  
R1 1K 1/4w Resistor  
R5 Sensitivity Adjust 10K Trimmer  
C1, C2 10nF Disk Capacitor  
1 x IN5711 Diode  
T68-2 Core  
1m 0.5mm Enamelled Copper wire (Colour 1)  
250mm 0.5mm Enamelled Copper wire (Colour 2)  
2 x 270pf Dual Poly Capacitors  
1 x Foam insulation tape  
1 x 5mm RED LED  
2 x SO239 or BNC Sockets (Depends on version)  
8 x 10mm SO239 mounting screws  
8 x M3 fixing nuts  
2 x M3 Solder Tags  
4 x M2.5 4mm var cap mounting screws  
2 x M2.5 12mm Shaft extender Screws  
2 x 10mm shaft extenders  
Two control knobs  
4 x Stick on feet  
Connecting single core Cable 350mm (or 2 x 150mm cables)



The Mini transmatch can be broken down into two sections, the first is a resistive SWR bridge.

This is the same circuit as used in our little SWR Indicator bridge kit.

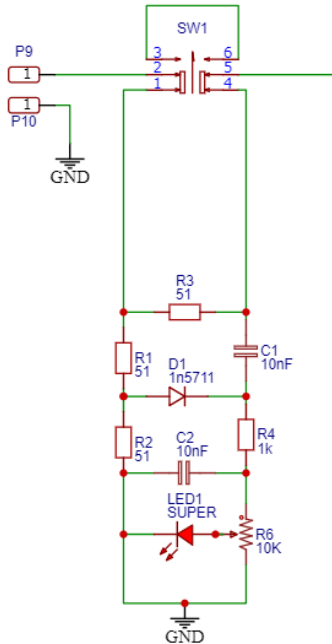

This section can be switched IN or OUT by a two way toggle switch, when in circuit the bridge will light the LED if the antenna is presenting an impedance higher (or Lower) than 50 ohms, if the impedance is matched the LED will go out. Depending on the power level in use the LED can be either too bright and doesn't go out when matched or too dim and hard to see. This circuit has an adjustable sensitive trimmer and it is best to adjust this to suit your most likely used power level.

The second part of the transmatch is the ATU section.

The ATU section uses a T68-2 core comprising of

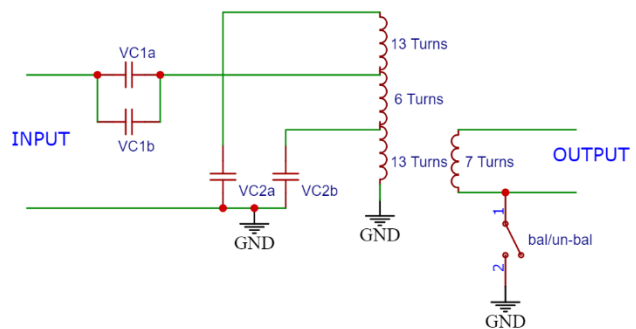

13/6/13 turns on the primary and 7 turns on the secondary, the output can be isolated by means of a grounded toggle switch so the user can use either balance or unbalanced antennas.

The number of turns on the output stage could be adjusted to work with lower impedance antennas (try just 3 or 4 turns if you want to play) the only problem with reconfiguring this setup is that efficiency can suffer

The Toroidal and its windings are the most difficult part of the build and if not right the ATU will not work correctly.



There are many videos on YouTube showing how to wind them that may help. But here are the instructions you need to make the coil. If you are reading this from the paper instructions you may want to look on the instruction page on my web site for a copy in colour that may be easier to follow. Find the first colour wire (its about 1m long) pass it through the toroidal as shown here, leave the one end about 50mm long. This counts as one turn, every time the wire passes through the core it counts as a turn,



Continue to wind the wire for a total of 13 turns as in the picture on the right.

Note the direction that I have wound it.

Note the direction that I have wound it.



Now we need to form a loop.

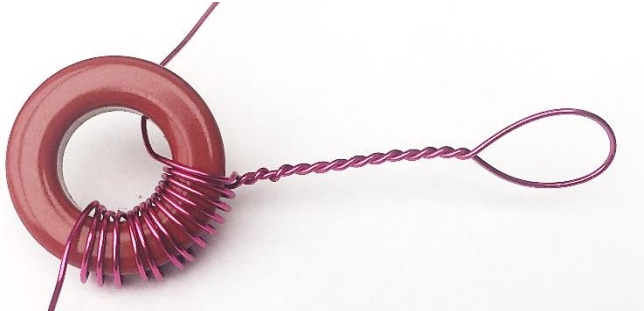

Form a loop about 30-50mm long as shown here, feed the wire back into the core and wind for another 6 turns.

The toroidal should be looking like this now.

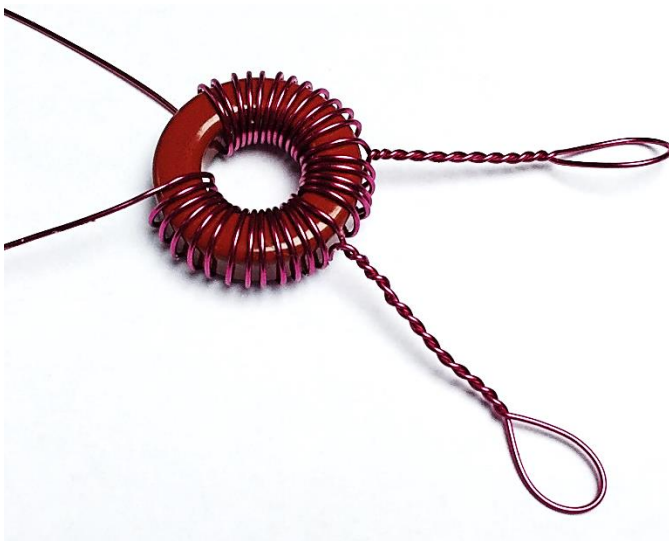
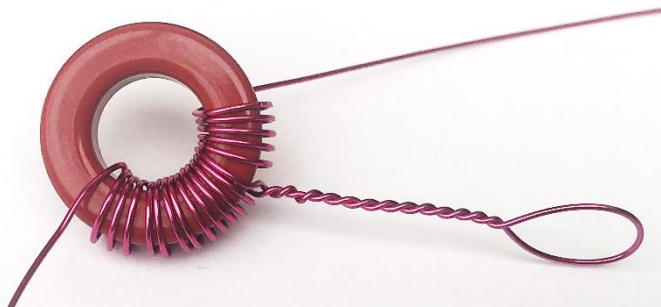

Now form another loop as before and then continue to wind the toroidal with another 13 turns.

So far we should have 13 turns then a loop followed by 6 turns and a loop and a final 13 turns. Double check that you have this correct before we move on. A good way to count the turns is to use a digital camera (phone) and take a picture, zoom into the picture on the screen and then you can count the turns

much easier than trying to count them on such a small core.

That completes the main windings but we still have one more winding to do.

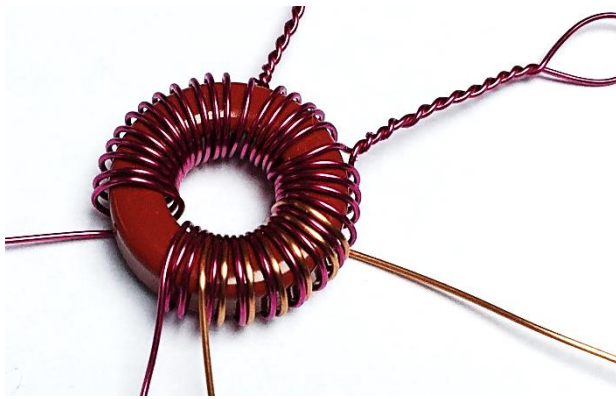

Now find the 2<sup>nd</sup> coloured wire, it is much shorter than the first wire (only about 25cm)

If you are using paper instructions you may find it hard to see this picture so look on my website for a colour copy if that helps.

Now this winding is only 7 turns but you need to wind them BETWEEN the winding already on the core, start 3 turns from the end of the coil and very carefully wind this new coil so the copper wire is between the turns of the purple

coil. Look carefully at the picture and make sure you wind the second coil in the same direction as the picture shows.

Hopefully you will produce a nice neat set of windings, take your time this is a very important part of the transmatch and the performance will be reduced if this is not done correctly.

Next I suggest fitting the three 2 watt resistors, you need to keep the off cuts from these resistors.

Now we can fit the toroidal, you first can tin the leads, this is the hardest part of the kit to fit and probably the most important part to get right.

The enamel on the wires is a special enamel that will burn off if treated correctly. You need a good soldering iron that keeps its heat for this, you can help it by scraping the wire or lightly sanding the wires from the toroidal first to break the enamel insulation. When tinning these wires you will need to apply the soldering iron and solder for about 10 secs or so, normally a puff of smoke will come off the wire when the enamel burns off and the solder will then flow over the wires. Don't breath in these fumes, I am sure that they are not good for you. In fact all solder fumes are to be avoided. Make sure you have plenty of ventilation in the work area.

The first two wires I tin are the two loops, makes sure the two wires of the loop are well twisted together first and then trim the loop so it's about 10mm long from the coil. Now apply your soldering iron to this pig tail and I find applying solder to the tip while rubbing the irons tip over these wires helps to burn off the enamel, make sure that the solder flows nicely over the pig tail just about up to the core.

Now leave the 4 other wires one to two inches (25-50mm) in length. Again apply the soldering iron and solder to the wire near to the core, we need about 10-15mm of wire from the core to be tinned. You will need to apply the iron for around 10secs or so to burn off the enamel with a puff of smoke.

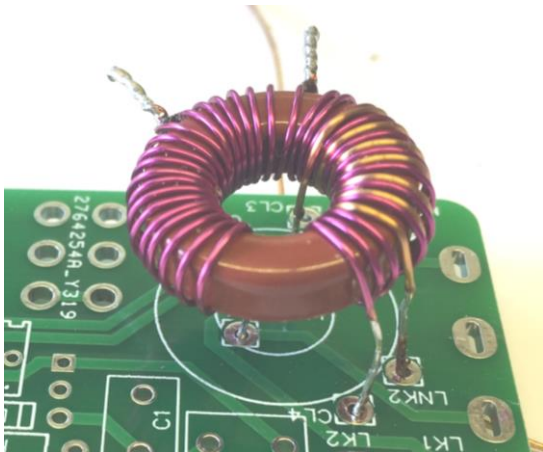

Now fold the 4 wires downwards as per this picture, I find trimming each lead to a different height makes it easier to fit the toroidal to the board, just feed the wires one by one into the correct hole.

When the Coil is fitted flush to the board solder each of the 4 leads. Now its worthwhile checking for continuity for both windings.

With a test meter check that there is a short circuit between CB1 and CBGD. Then check for a short circuit between the two large solder pads just above CB1

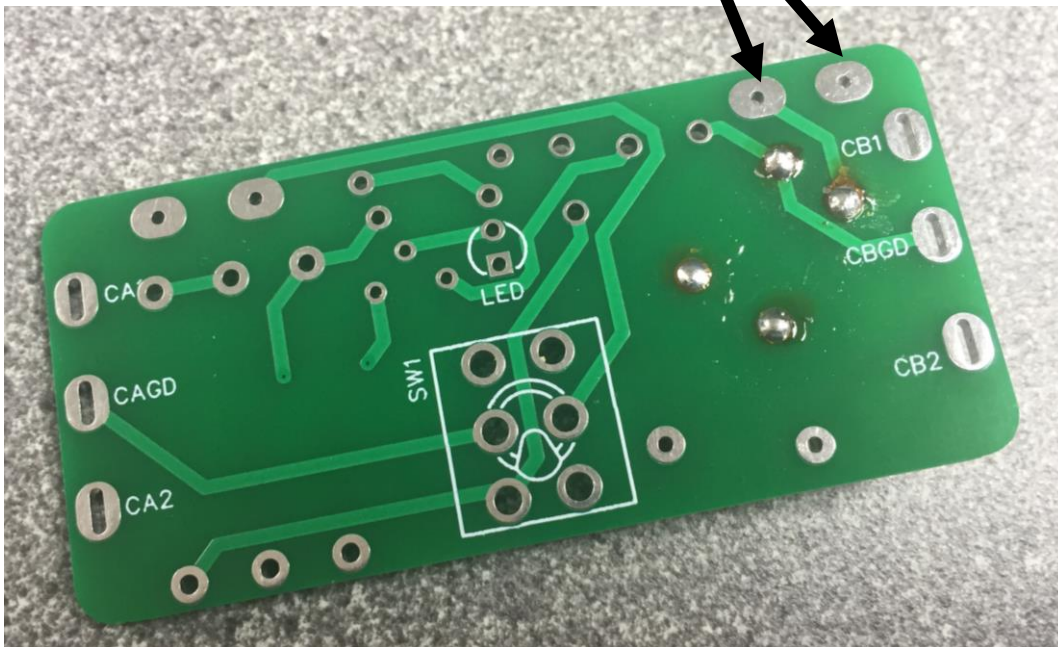

Now we kept those cut off leads from the resistors, find two nice long ones and make them into little walking sticks like the picture here. (save the others for later too!)

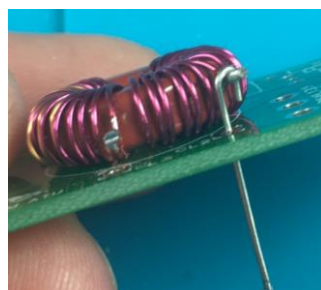

These hooks are fed through the board to connect the coil taps to the PCB.

Do this for both taps of the coil and solder in place, trim the wires when done.



The board should now look like this.

Now we can carry on installing the remaining parts.

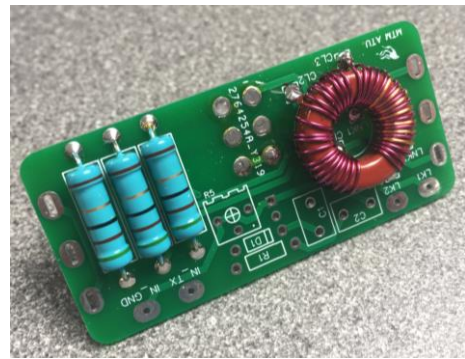

Now turn the board over so we can fit the switch, remove the top nut and washers from the switch and put them on one side for later. The switch should be fitted so its pins **JUST** fit flush with the other side of the PCB, this is so when the ATU is assembled into the case and onto the front plate there is enough of the screws thread protruding to attach the nut to. The nut is only cosmetic really so fitting it really is optional.

Now we can make a start fitting the smaller parts.

These next parts are simple to fit, start with the two yellow 10nf capacitors C1 and C2, they must be fitted on the same side as the large resistors. Next fit the 1K resistor and the 10 K trimer all on the same side. Finally fit the diode. Fit this so that the black band is nearest to the two yellow capacitors

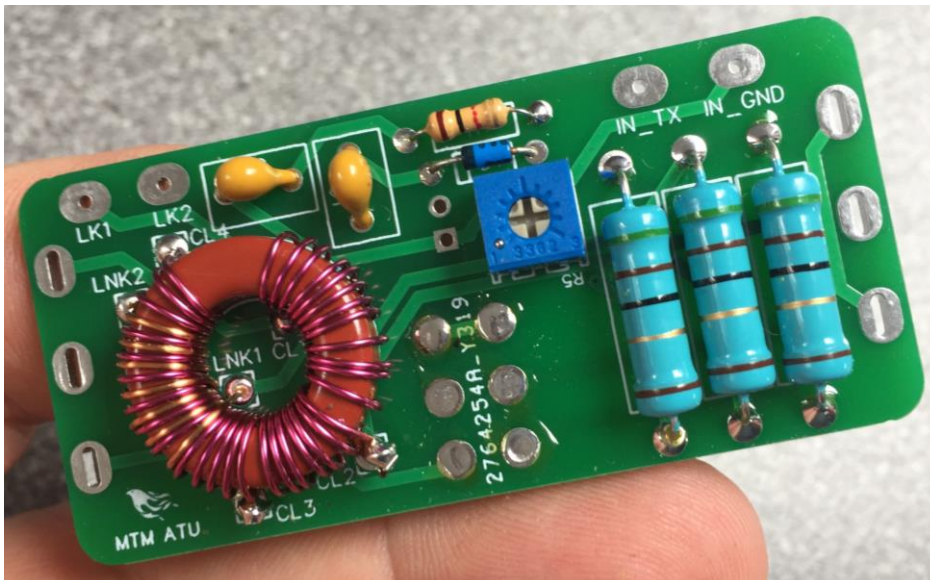

This is what the board should look like now.

The board shown here is an earlier board than the one in your kit so you may notice one or two little differences.

Now turn our attention to the front panel, and the two variable

capacitors. We need to fit these to the front panel but first we need to prepare them.



**IMPORTANT read all the following twice and look at the pictures BEFORE you cut the leads. Be 100% sure what you're doing at this stage. Check twice, cut once!**

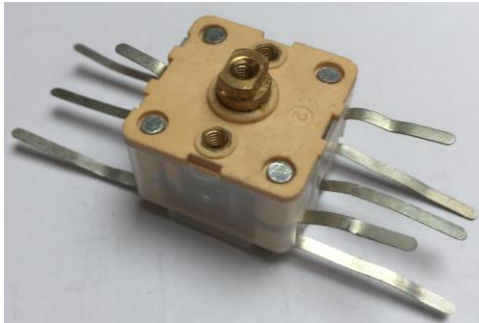

On one side of the capacitor there are 4 pins, the other side has 5. Make sure you identify each side

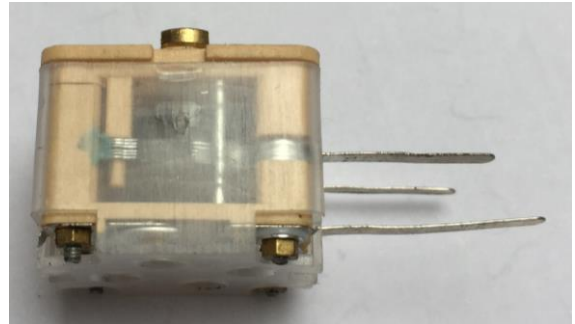

correctly, once sure snip off all the legs on the side with **4** pins.

Now on the 5 pin side half way down the body of the capacitor you will see one lead on the left and on the right, we **NEED** these so do not cut them! Under these leads we have 3 leads in a row, we only want the center lead, the other two need to be snipped off, snip them off right up against the body. Check twice before cutting them that you have the right ones, look at the other pictures below in the next stages to be sure you know which ones to cut.

#### IMPORTANT Note

Keep the off cuts, remember the QRP motto 'Do more with less' (God bless you George) . We may have a good use for them a little later on....

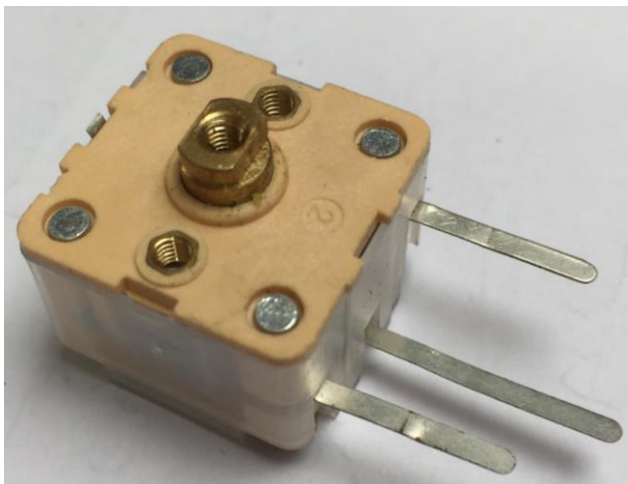

If you have a suitable capacitance meter check between the center pin and the two outer pins, you should find that you have about 270pf when you adjust the capacitor between each pin and center.

Now we can fit the shaft extenders to the capacitors, you will find 10mm black extender tube and 2.5mm x 12mm screw, when tightening the extender be careful not to damage the internals of the capacitor by applying to much

force to the body of the capacitor. Use a pair of cutters or needle nose pliers to hold the small brass shaft on its two flats when tightening the 12mm screw.

On the back of the capacitor there are 4 trimmers, we are not using any of them but I still like to set them fully open. If you don't do this it's not going to cause a problem but I still recommend doing this.

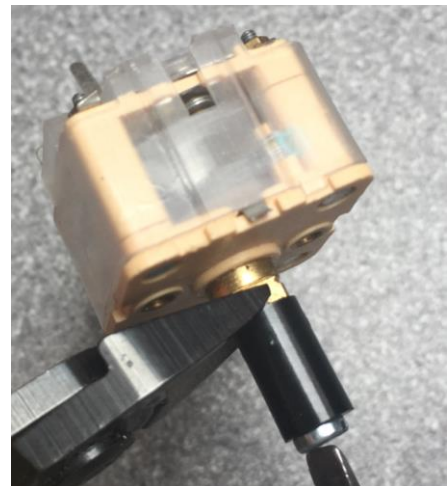





When the capacitors are ready we can move on. Attach the two capacitor to the front plate with the 2.5mm short screws provided.

Fold back the three remaining terminals from each capacitor as shown in this picture.

Now another important step. You will find a short length of very thin foam tape, cut this to fit the back of these capacitors. One side of the foam has a paper backing, the other side has a plastic

peelable backing, remove the plastic backing and stick the foam to the back of the two capacitors. This foam makes sure that we get no short circuits from back of the PCB solder points when we bolt it all together. Make sure the tape is a little larger than the base of the capacitors.

Now let's mount the main PCB and the front panel.

Very carefully lower the PCB onto the front panel assembly **BUT FIRST**

Drop the LED into place on the PCB, **do not** solder it just yet. The long leg of the led must go into the round hole. The led must be fitted from the back of the main PCB as shown here. (The same side as the switch)

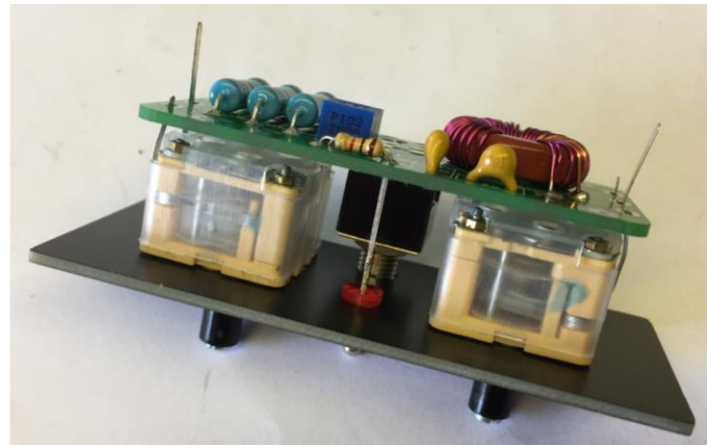

Carefully make sure that the three legs of each capacitor go into their correct mounting holes and that the LED isn't trapped or falls out while doing this. A bit fiddly I know.

When all in place just have a good inspection to makes sure all the capacitor legs are correct and the LED is in place. Make sure you did not miss the foam tape! Push the board down and solder the capacitor legs in place. Trim these flush when done.

Make sure the LED is push through the front panel and solder the legs on the PCB, they will only just be visible.

Now we can work on the rear panel.

There are two different end panels depending if you're using SO239 sockets or BNC's.

The idea is the same which every panel you are using, the instructions here show the use of SO239's.



Use the screws/nuts provided to mount the sockets to the back panel. Place the two earth tags on the back of the socket on the holes nearest the switch as per the picture here. If using BNC's tighten the sockets and make sure the earth tag is on the side near the switch.

Remember I told you to keep the off cuts from the capacitor leads. Find the two longest ones. We are going to use them to connect between the earth tags and the switch. It is important to use a sizable conductor for these links or you will not get a good SWR. I find these off cuts are nice and wide and do a good job since they are just going to be thrown out it makes good sense to use them, connect one tag to the top of the switch and the other tag to the middle terminal of the switch.



If you have thrown these away then you can also use any sizeable conductor around  $1\text{mm}^2$  or so would be ideal. ( I have also use the offcuts from those 2 watt resistors we fitted earlier, see below)

Now fit the links to the back panel, I have provided some silicone coated wire for this, it's very flexible.

Solder 4 short lengths of this wire as shown, about 2 inches long. (I now supply red and black wire)

The picture here shows the tags connected to the switch using the thick resistor leg off cuts.

The tags on the sockets go to the top terminal of the switch and the center terminal.

Now drop the front and rear panels into the case, the groove pattern on the case should be nearest to the back panel. The bottom part of the case has a hole drilled in it for the fixing screw.



Trim the length to suit and solder the 4 wires to the large input and output pads on the main PCB,

Note the cross over on the Antenna side.

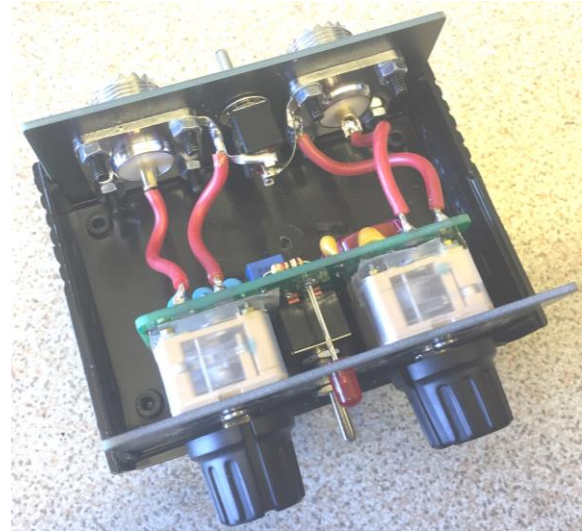
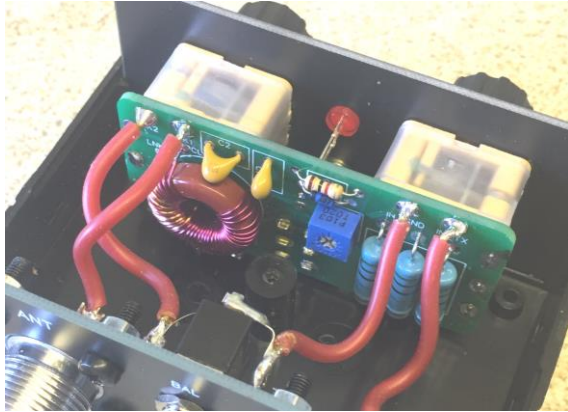

The Mini Transmatch is complete! Just pop the top on attach with the one long case screw and fix the four stick on feet.

Using the Mini Transmatch

The Transmatch is easy to use, much easier than many manual ATU's. While tuning I recommend reducing powder if you can (be nice to other Hams) with the ATU fitted between the radio and the antenna first set the controls to the 12 o'clock position. Set the radio to the required operating frequency, adjust the two ATU controls for max noise in the receive, this will normally put you in the right ball park anyway, with the ATU switched to 'Tune' give a steady RF carrier. The LED will light (unless already at the best spot!) Adjust the two controls to find the point where the LED goes out (or becomes very dim). This is the sweet spot and you will find that you have a good usable match to the antenna. Flick the switch back to operate and you're done. If you have a SWR indicator on the radio you may be able to tease the SWR down further now by making very small adjustments to the controls. The LED indicator will normally go out around a SWR of 1.5:1, this is a perfectly usable match and further improvement will have little advantage. Many of us over worry about wringing the last fraction of match from a ATU, When the light goes out your good to go. After a short while you will begin to trust the LED indicator and stop looking at the Radios SWR meter.

### **Trouble shooting.**

As long as you have built the ATU correctly you should not have problems in use but a couple points of note. If the LED is very dim at all settings of the controls you may have the sensitivity trimmer set to low, the LED gets its power via a voltage produced when there is a mismatch, All LEDs need a minimum voltage to operate, there is a little trimer on the main PCB that allows you to adjust the sensitivity (and brightness) of the LED, I like it very bright so tend to turn the sensitivity to max (well just under it really), with a low power carrier applied adjust the trimer to give a bright LED .

You just can't tune an antenna on a certain band?

ATU's have their limits, sometimes they just can't give you a match. Try the antenna on a different band to start with, if you can match it then you most likely have a difficult length antenna, sometimes if the antenna can present a very high impedance (or very low) at a certain frequency, try



adding a few feet to the length (or shorten if you don't have the room) and test again, just a few feet can make a massive difference. Also the feed cable (Coax) length can cause problems, if you can try a shorter or longer length just a few feet can make all the difference.

If you have a balanced feeder you will need to provide an adapter to allow this to be connected to the ATU, make sure that you flick the switch on the rear to BAL in this case (Normally should be set to Un-Bal for coax feeds).

I hope you enjoyed building the MTM-ATU and that it gives you good service.

73 Paul MOBMM