

mAT-1500Pro ANTENNA TUNER OPERATION MANUAL

Thank you for choosing this our product.

Please **READ ALL INSTRUCTIONS** carefully and completely before using this tuner.

■ IMPORTANT

- ◆ **NEVER** touch the antenna or antenna connector with your hand when the transmitter is transmitting, it will cause burns!
- ◆ **NEVER** use the antenna tuner during a lightning storm. It may result in an electric shock, cause a fire or damage the tuner. Always disconnect the antenna before a storm.
- ◆ **NEVER** operate the tuner with its cover removed. Contact with the components inside the tuner while transmitting will result in painful RF burns.
- ◇ Always turn your transmitter off before plugging or unplugging anything, otherwise it would be damaged.
- ◇ The tuner is designed for indoor operation only, it is not waterproof. If you use it outdoors, you must protect it from rain, dew and steam.
- ◇ We cannot guarantee the mAT-1500Pro tuner will work well with those YAESU transmitters which are released later than the tuner.

■ INTRODUCTION

The mAT-1500Pro is a multipurpose high-power automatic antenna tuner that can match almost all transmitters and amplifiers. The maximum RF power allowed is 1500 watts (SSB), and two antennas can be connected at the same time. According to the different connected transmitters, the tuner has three working modes, YAESU mode, ICOM&KENWOOD mode and GENERAL mode. The tuner can automatically determine and match the type of the currently connected transmitters to minimize the manual operation and enhance the automation and convenience of the wireless communication system.

Front: There are 3 indicator lights on the left to show the current mode of the tuner. There are 4 buttons& indicator lights on the right to operate the tuner and indicate the status.

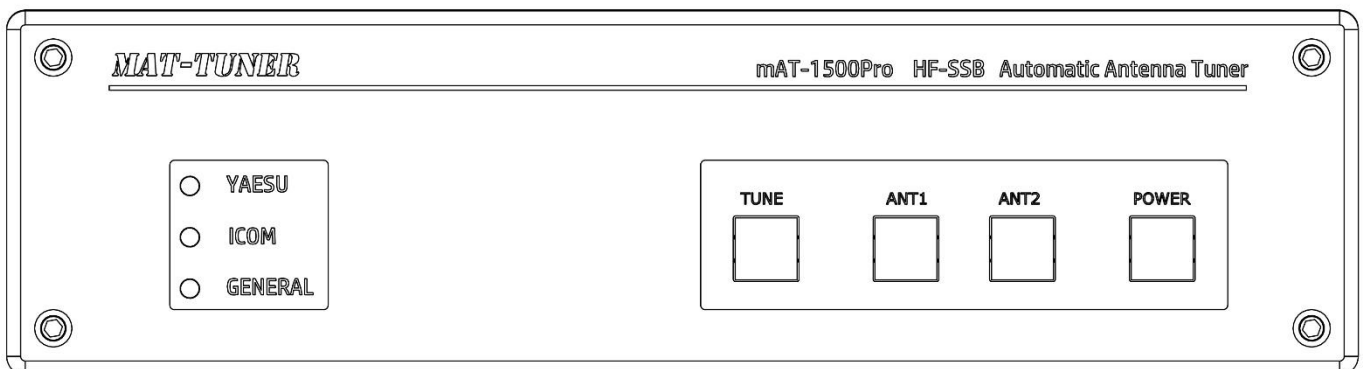

Rear: There are 3 sockets(SO-239) -“ANT1”, “ANT2” and “RF IN”- on the left to connect Antenna 1, Antenna 2 and amplifier or transmitters. You could find the uses of all the other terminals on the right from the label.

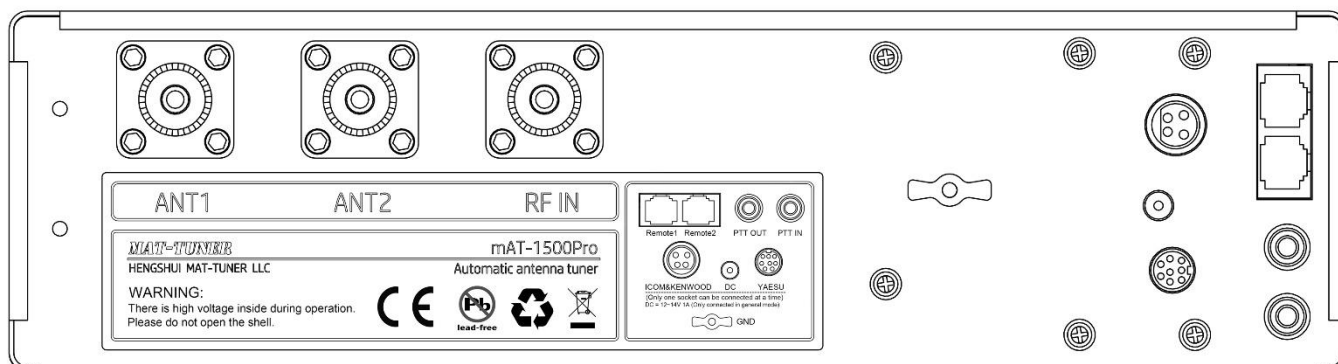

■ CONTROL CABLE CONNECTION FOR THREE WORKING MODES

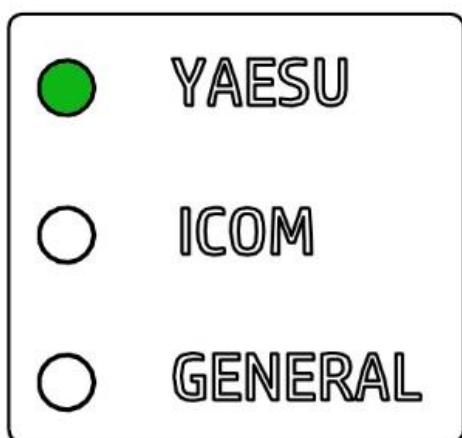

The tuner has three working modes: YAESU mode, ICOM & KENWOOD mode, and GENERAL mode. Users could accomplish one-button operation on the transmitter for maximum automation while using the first two modes.

Display of the current working mode:

The light will turn green when the corresponding mode is on.

1. YAESU mode

(1) Use the mAT-CY control cable (optional, not standard accessory) to connect the "YAESU" control socket on the rear panel with the "TUNER" socket of the Yaesu transmitter. When the transmitter is turned on, the tuner will automatically set to this mode. And the wiring of the rear panel is shown in the following figure. The transmitter uses this cable to control and supply power to the tuner.

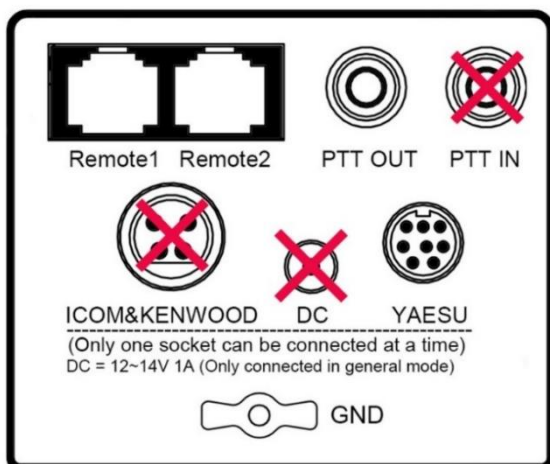

(2) If there is a cable connection between your transmitter and amplifier, please confirm whether this cable contains PTT signal. Usually, this signal is in the first core of the transmitter "LINEAR" socket, or a control cable with two sections of RCA lotus plug. **If the PTT signal is included, be sure to disconnect it.**

(3) Use an RCA control cable to connect the "PTT OUT" socket of the tuner with the PTT IN socket of the amplifier. Please read the operation manual of the amplifier to determine this socket. This RCA control cable comes with the tuner as a standard accessory.

Step 2-3 can cut off the PTT signal of the amplifier during the tuning cycle to make sure it is bypass and protect your tuner from damage. **Or the amplified RF power will destroy the senser of the tuners.**

(4) Keep other sockets such as "ICOM&KENWOOD", "DC" and "PTT IN" free.

2. ICOM&KENWOOD mode

(1) Use the mAT-CI control cable (optional, not standard accessory) to connect the " ICOM& KENWOOD " control socket on the rear panel with the "TUNER" socket of the Icom transmitter or "AT" socket of the Kenwood transmitter. When the transmitter is turned on, the tuner will automatically set to this mode. The transmitter uses this cable to control and supply power to the tuner.

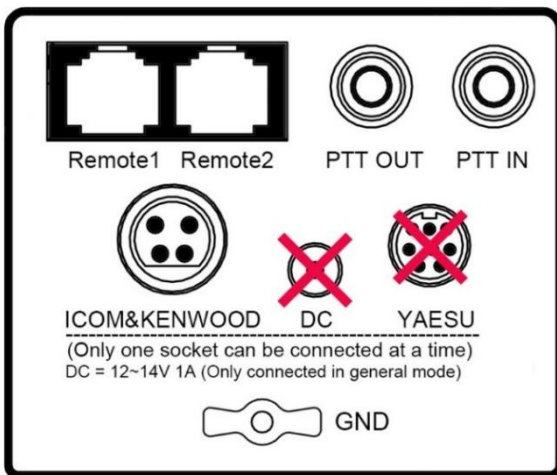

(2) If there is a PTT signal cable between your transmitter and amplifier-- usually this is a cable with lotus plugs at both ends. **If the PTT signal cable is conected, be sure to disconnect it.**

(3) Use a RCA control cable comes with the tuner to connect the "PTT IN" control socket of the tuner to the PTT signal output socket of the transmitter. Please read the operation manual of the transmitter to make sure you've connect the right PTT socket.

(4) Use another RCA cable comes with the tuner to connect the "PTT OUT" socket of the tuner to the PTT

input socket of the amplifier.

Step 2-4 can cut off the PTT signal of the amplifier during the tuning cycle to make sure it is bypass and protect your tuner from damage.

(5) Keep other sockets such as "YAESU", "DC" free.

3. GENERAL mode

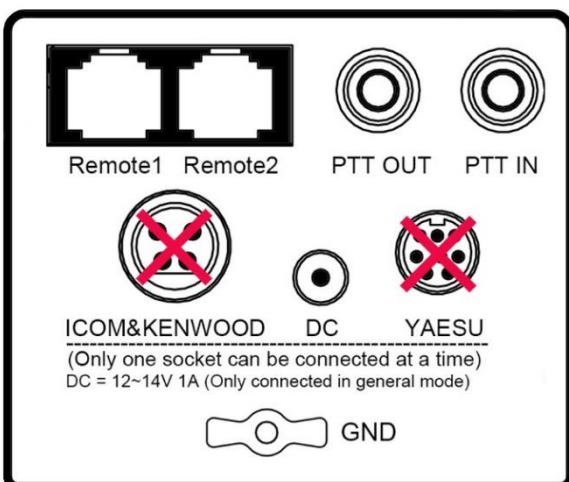

If you use transmitters other than Yaesu, ICOM or Kenwood with an external DC power supply connected, when you press the "POWER" button on the front panel to start, this mode will be set automatically. The voltage of external power supply shall be in the range of 10-15v, and the maximum working current shall not be less than 1A. Other cable connections are described below.

(1) If there is a PTT signal cable between your transmitter and amplifier-- usually this is a cable with lotus plugs at both ends. **If the PTT signal cable is conected, be sure to disconnect it.**

(2) Use a RCA control cable comes with the tuner to connect the "PTT IN" control socket of

the tuner to the PTT signal output socket of the transmitter. Please read the operation manual of the transmitter to make sure you've connect the right PTT socket.

(3) Use another RCA cable comes with the tuner to connect the "PTT OUT" socket of the tuner to the PTT input socket of the amplifier.

Step 1-3 can cut off the PTT signal of the amplifier during the tuning cycle to make sure it is bypass and protect your tuner from damage.

(4) Keep other sockets such as "YAESU", "ICOM&KENWOOD" free.

IMPORTANT:

1、 Make sure the tuner controls the PTT signal sent by the transmitter to the amplifier of all the modes. Otherwise it will cause damage to the tuner which is not covered by the free warranty.

2、 Do not connect the sockets "ICOM&KENWOOD", "YAESU" and "DC" on the rear panel at the same time.

RF CABLE CONNECTION

Except the control cable, DC power cable and PTT signal cable, the RF cable should also be connected correctly according to the markings on the rear panel. The "RF IN" socket on the rear panel is used to connect an antenna socket of the amplifier. Users should prepare The RF cable by themselves and it is able to transmit high-voltage and high-current well.

Caution: The tuner must be connected between the antenna and the amplifier. DO NOT connect the tuner between the amplifier and the transmitter.

The RF sockets marked as "ANT1" and "ANT2" are used to connect the antenna. Users can connect up to 2 antennas at the same time. The "ANT1" and "ANT2" buttons on the front panel can easily switch which one to use. You can choose any socket while only one antenna is working.

Remote1、 Remote2

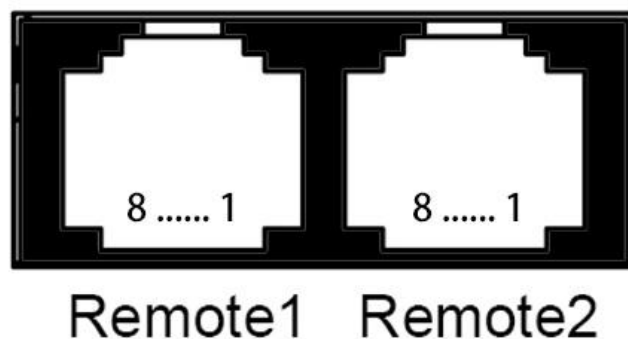
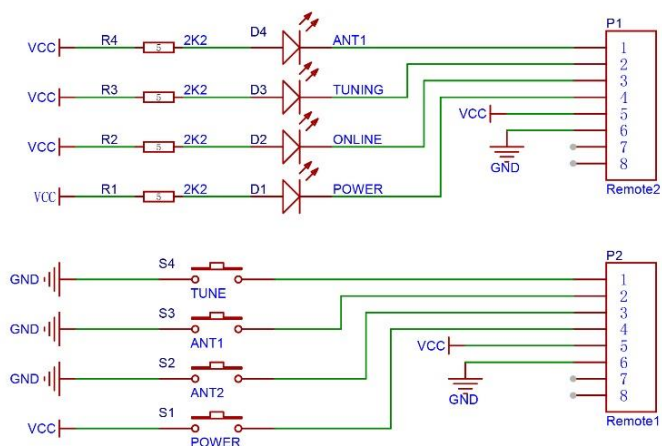

Remote1 and Remote2 are standard RJ45 sockets, and their wiring sequence is shown in the

figure above. There are a total of 16 pins with buttons and indicators of the tuner. Users can operate the tuner remotely through these two sockets. High quality shielded network cable is strongly recommended to make a remote control terminal refer to the schematic diagram. The distance between the control terminal and the tuner should be as short as possible.

■ GND

In order to ensure the normal operation of your equipment, we recommend that you connect the "GND" grounding terminal on the rear panel with GND of the amplifier, transmitter and other equipment to the ground.

■ OPERATION IN YAESU AND ICOM&KENWOOD MODE

Our mAT-1500Pro is fully compatible with the three brands of transmitters. You can operate the tuner simply and conveniently through "TUNE" button in Yaesu transmitter or "AT" button in Icom& Kenwood transmitter on the front panel.

In these two modes, the "TUNE" and "POWER" buttons on the front panel will only be indicator lights. The " TUNE " button is used to indicate the status of the tuner---“on” for ONLINE and “off” for BYPASS. And the "RF IN" RF socket is directly connected to "ANT1" or "ANT2" in the status of BYPASS.

"Power" button is the power indicator.

Note: For some transmitters, it is necessary to set before using the external tuner. For details, please read the transmitter manual carefully.

■ OPERATION IN GENERAL

If there is only an external DC power supply connected without any control cables, the mAT-1500Pro is a high-power universal tuner.

Startup and shutdown: Press the "POWER" button on the front panel. This button also acts as a power indicator.

Online / Bypass switching: Press the "TUNE" button shortly on the front panel to switch "ONLINE" / "BYPASS". The "TUNE" button light is lit when ONLINE.

Start a tuning cycle:

- 1、 Before starting a tuning cycle, please make sure that the amplifier has been set to "BYPASS" state (not activated), otherwise the tuner will be damaged.
- 2、 Change the transmitter mode to any one of FM/FSK/RTTY/CW, and set the RF power to 10W.
- 3、 Press and hold the "TUNE" button of the tuner until the button starts flashing green and then release it.
- 4、 Then press and hold the PTT of the transmitter, let the transmitter output a stable carrier, and the tuner will start a automatic tuning.
- 5、 It is normal for tuners to make a loud clicking sound during tuning., It will finish tuning after the sound is over.
- 6、 Press the PTT of the transmitter to view the current SWR through the SWR meter of the transmitter or the external SWR meter. If the current SWR is not higher than 1:1.5, the power level

and mode of the transmitter can be restored to the previous settings. Set the amplifier to the active state. This completes the tuning.

7、 If the SWR after tuning is higher than 1:1.5, please adjust your antenna system and repeat steps 4-6.

■ SWITCH ANT1 AND ANT2

The mAT-1500Pro tuner can connect two antennas at the same time and you can easily switch which antenna to use by pressing the "ANT1" or "ANT2" button on the front panel while the current button light is up.

Important: Do not switch the antenna when the transmitter and amplifier are transmitting, otherwise your equipment will be damaged. The tuner can only be switched when the transmitter is receiving. You need to restart the tuning cycle after switching.

■ ACCESSORY

6.5mm DC power line (intermediate contact diameter 2mm)	Standard
RCA control cable, 2pcs	Standard
mAT-CY control cable for Yaesu	Optional
mAT-CI control cable for ICOM	Optional
mAT-CK control cable for Kenwood	Optional

■ ELECTRICAL

- Frequency Range: 1.8 ~ 54 MHz
- Input Power Capability: 1500W(SSB), 800W(DATA mode)
- Input Power Capability: 0.5-15W
- Input Power Capability: ≤ 5 S(Programmed), 0.1S (From pre-saved frequencies in memory)
- Operating Temperature: -10°C ~ +60°C, 14°F ~ 140°F
- Channel: 16000
- Power Requirements: DC 12-14V, Max 1A
- Dimensions (H x W x L): 290 x 243 x 78mm, Package dimensions: 337 x 312 x 144mm
- Weight:3.5Kg, Gross weight: 4.1Kg

■ TECHNICAL SUPPORT

Visit the web: <http://www.mat-tuner.com/> for more information and operation manual. In order for you to get better service, we recommend you to buy my products from your local distributor.

HENGSHUI MAT-TUNER LLC

No.28 Ronghuabei ST, Hengshui, CHINA

<http://www.mat-tuner.com>

E_mail: bg3mzu@gmail.com, mail@mat-tuner.com