

## FDARC X-Phase QRM Eliminator

Below are some basic instructions to get you going.

When you get your kit, it will come with a circuit diagram.

- (1) Find somewhere to assemble the kit where you stand a decent chance of finding any dropped components. It always seems to happen to me.
- (2) Use a sheet of paper or light-coloured surface to work on.
- (3) Check off all of the components against the circuit diagram provided. Don't open up the surface mount ones until you need to use them. You should be able to work out which are which by a process of elimination and the pictures below.

The circuit board is screen printed on both sides.



All the through hole components are fitted on one side and all of the surface mount components are on the bottom of the PCB (When completed). For this reason, you will find starting by soldering the SMD devices first will allow you to lay the board flat.

To aid you with recognition here are some examples of what the components look like.

### Relay

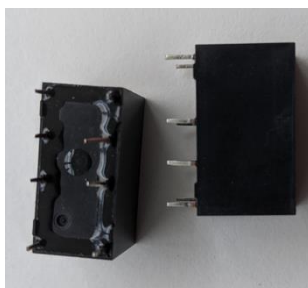

**Diode**

Make sure they are the right way round

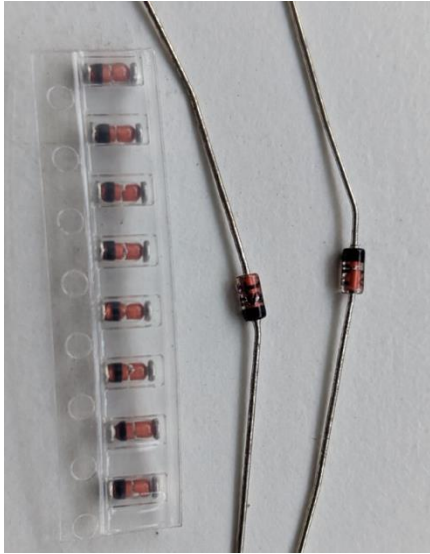
**Capacitor (Note no writing on the SMD)**

The big black electrolytic needs to be put in the right way round -ve goes to the outside edge of the board.

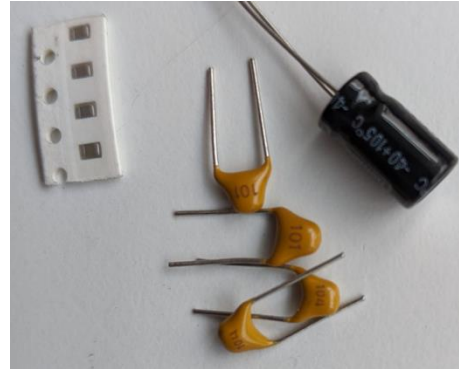

**Inductor** (Looks like a resistor but green in this case).

**Transistors**

VT1 is the SMD transistor

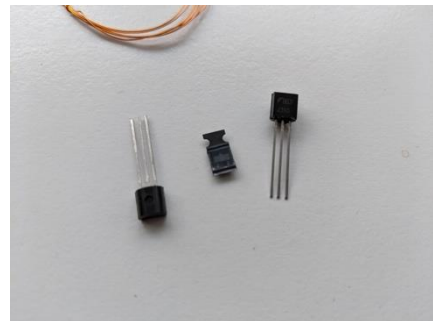

**Resistors** (Not easy to see but the SMD's are black with numbers on them)

The easiest way to identify values is with a multi-meter.

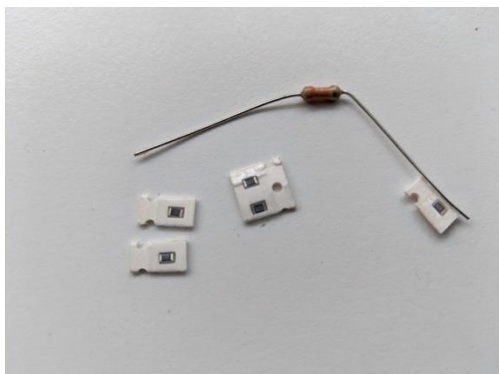

- (4) Start with the SMD devices and check them off the circuit diagram as you add them.
- (5) You can test you have soldered them correctly by using a multi-meter. Take your time and rework any you are not happy with then move onto the next component
- (6) Winding the transformer – Tr1 = 2 turns Primary and 8 turns secondary.  
C = 1 Turn    D = 2 Turns

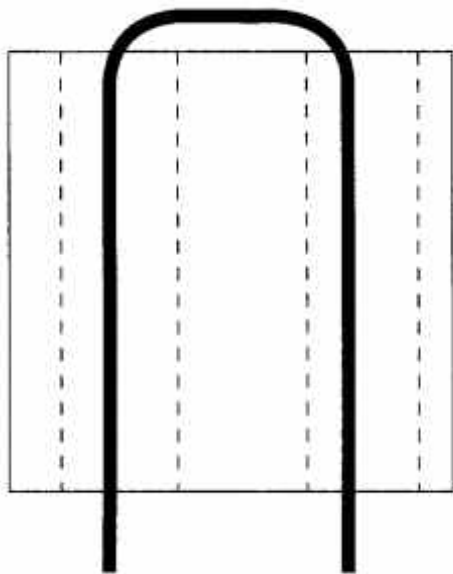
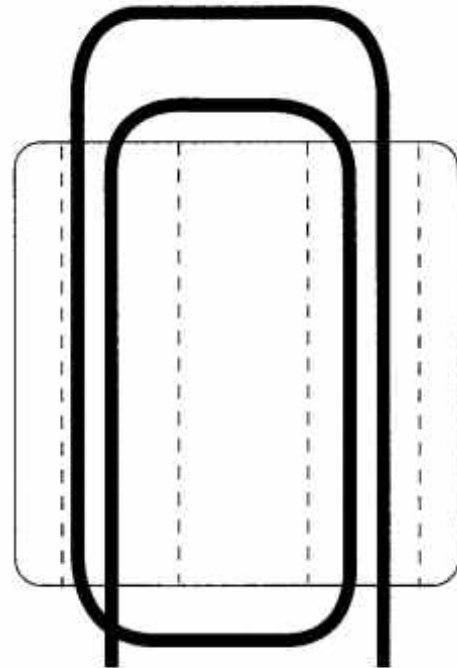
**C****D**

- (7) You can now go ahead and add the remaining through hole components.  
REMEMBER THESE ARE ALL INSERTED ON THE OTHER SIDE OF THE BOARD AND  
SOLDERED ON THE SAME SIDE AS THE SMD COMPONENTS

No components left? Congratulations you should be ready to test your completed circuit board

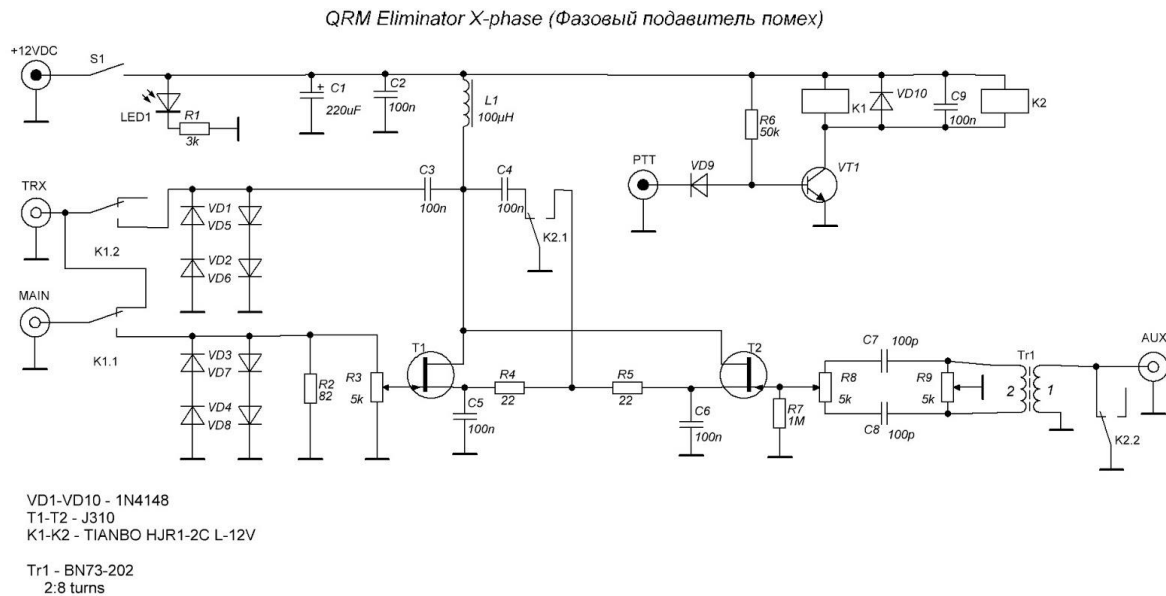

**Additional Parts:** The Kit comes as the unpopulated PCB along with the components to complete the PCB to a working state. In addition to this you will need to source the Following:

- 3 x RF connectors of your choice (BNC, SO239 etc)
- 1 x PTT control socket (RCA Socket or 3.5mm jack)
- 1 x 5.5mm Power socket or Gromit if you intend to hard wire
- 3 x Control Knobs
- 1 x Power Switch
- 1 x LED Lamp
- Hookup wire
- Power lead with fuse
- 2 x Nuts, bolts shims for mounting the PCB

On completion of the PCB a Case will be supplied by the club. Which you can have predrilled on request.

**Tools:**

- Soldering iron, solder and flux
- Tweezers
- Multi-meter that measures Capacitance and Resistance