

# POWER SUPPLY KIT

MODEL XP-15K

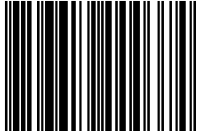

7 56619 00037 4



Instruction & Assembly Manual

## ELENCO®

## INTRODUCTION

Assembly of your XP-15K Regulated Variable Power Supply Kit will prove to be an exciting project and give much satisfaction and personal achievement. If you have experience in soldering and wiring technique, you should have no problem in the assembly of this kit. Care must be given to identifying the proper components and in good soldering habits. Above all, take your time and follow the easy step-by-step instructions. Remember, "An ounce of prevention is worth a pound of cure". Avoid making mistakes and no problems will occur.

**USE SAFETY GOGGLES WHEN ASSEMBLING THIS KIT!!**

## SPECIFICATIONS FOR XP-15K POWER SUPPLY

Output Voltage	0 - 15VDC	Ripple Max.	0.01V rms
Output Current	0.3A @ 12V, 0.2A @ 15V	Short Protection	IC THERMO
Load Regulation	0.1V	Output Impedance	0.3Ω
Line Regulation	0.1V		

## PARTS LIST

If you are a student, and any parts are missing or damaged, please see instructor or bookstore. If you purchased this kit from a distributor, catalog, etc., please contact ELENCO® (address/phone/e-mail is at the back of this manual) for additional assistance, if needed. **DO NOT** contact your place of purchase as they will not be able to help you.

### RESISTORS

Qty.	Symbol	Description	Color Code	Part #
<input type="checkbox"/> 1	R2	150Ω 5% 1/4W	brown-green-brown-gold	131500
<input type="checkbox"/> 2	R1, R4	2.2kΩ 5% 1/4W	red-red-red-gold	142200
<input type="checkbox"/> 1	R3	2kΩ Potentiometer		192421

### CAPACITORS

Qty.	Symbol	Description	Part #
<input type="checkbox"/> 1	C2	4.7μF 50V Electrolytic	264747
<input type="checkbox"/> 1	C4	220μF 16V Electrolytic	282244
<input type="checkbox"/> 1	C3	470μF 35V Electrolytic	284746
<input type="checkbox"/> 1	C1	2,200μF 35V Electrolytic	292226

### SEMICONDUCTORS



Qty.	Symbol	Description	Part #
<input type="checkbox"/> 8	D1-8	1N4001 Diode	314001
<input type="checkbox"/> 1	U1	LM317 Regulator	330317
<input type="checkbox"/> 1	D9	LED Red	350002

### MISCELLANEOUS





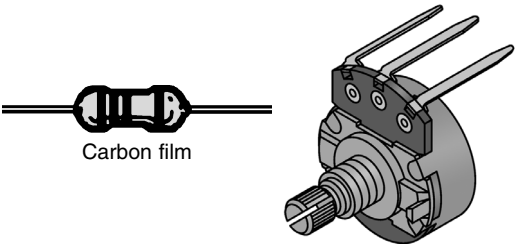
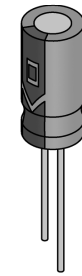

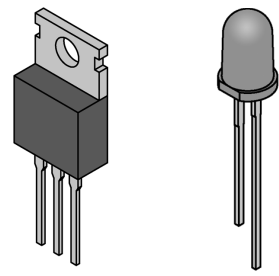

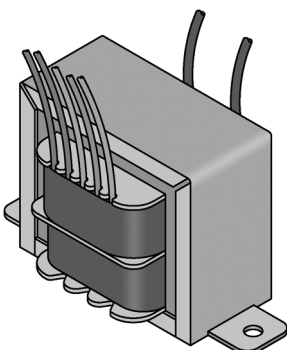
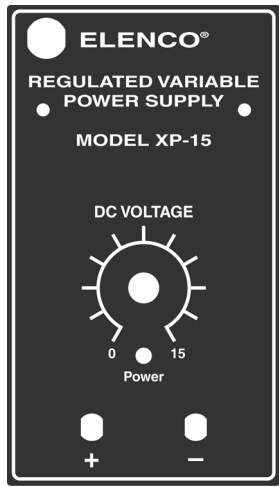
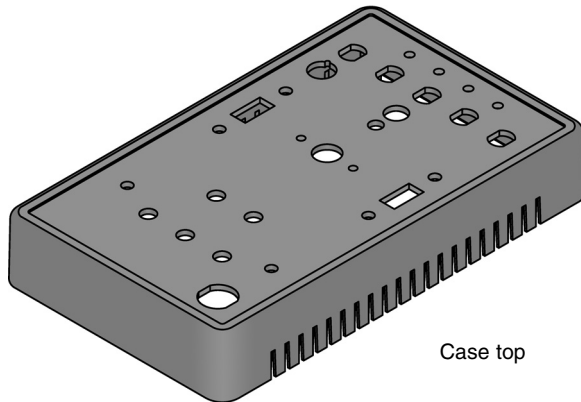
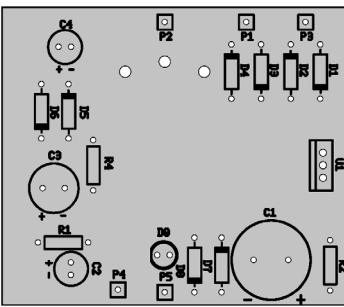
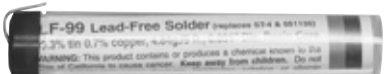
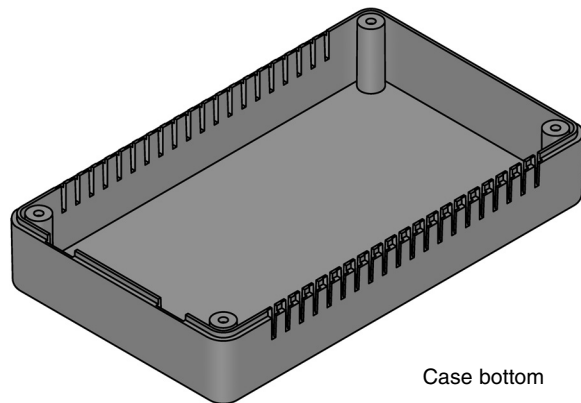
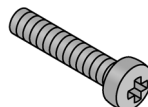

Qty.	Description	Part #	Qty.	Description	Part #
<input type="checkbox"/> 1	Transformer YD-1485	440111	<input type="checkbox"/> 2	Screw 6-32 x 3/8" Blk	641652
<input type="checkbox"/> 1	PC board	510002	<input type="checkbox"/> 1	Nut 7mm	644101
<input type="checkbox"/> 1	Heat sink	615009	<input type="checkbox"/> 1	Nut 4-40	644400
<input type="checkbox"/> 1	Knob	622009	<input type="checkbox"/> 2	Nut 6-32	644600
<input type="checkbox"/> 1	Case top	623061	<input type="checkbox"/> 1	Washer flat 8 x 14mm	645101
<input type="checkbox"/> 1	Case bottom	623062	<input type="checkbox"/> 4	Washer fiber #6	645602
<input type="checkbox"/> 1	Strain relief 2-wire	624002	<input type="checkbox"/> 2	Lockwasher #6	646600
<input type="checkbox"/> 1	Binding post black	625031	<input type="checkbox"/> 4	Rubber foot	662015
<input type="checkbox"/> 2	Nut binding post	625031HN	<input type="checkbox"/> 1	Label top	723071
<input type="checkbox"/> 2	Lockwasher binding post	625031LW	<input type="checkbox"/> 1	Line cord 2 wire	862100
<input type="checkbox"/> 1	Binding post red	625032	<input type="checkbox"/> 2"	Shrink tubing	890120
<input type="checkbox"/> 4	Screw 2.8 x 8mm	641102	<input type="checkbox"/> 1	Solder lead-free	9LF99
<input type="checkbox"/> 1	Screw 4-40 x 1/4"	641430			

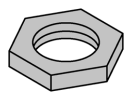
# PARTS VERIFICATION

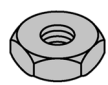
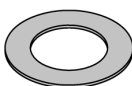
Before beginning the assembly process, familiarize yourself with the components and this instruction book. Verify that all of the parts are present. This is best done by checking off the parts in the parts list.

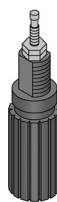
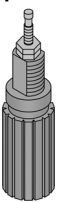
RESISTORS	CAPACITOR	SEMICONDUCTORS	
 <p>Carbon film</p> <p>2kΩ Potentiometer</p>	 <p>Electrolytic (radial)</p>	 <p>Diode</p>	 <p>LM317 Regulator</p> <p>LED</p>

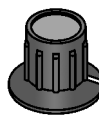
## MISCELLANEOUS

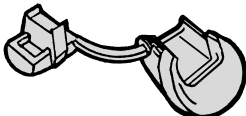
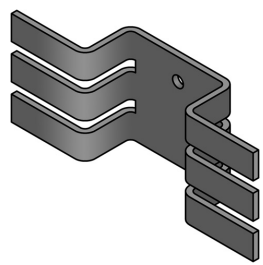
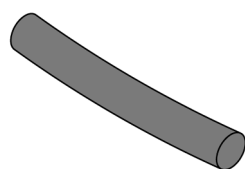
 <p>Transformer YD-1485</p>	 <p>Label</p>	 <p>Case top</p>			
 <p>PC Board</p>	 <p>Lead-free solder</p>	 <p>Case bottom</p>			
<p><b>Screws</b></p>  <p>2.8 x 8mm</p>  <p>4-40 x 1/4"</p>  <p>6-32 x 3/8" black</p>	<p><b>Nuts</b></p>  <p>7mm</p>  <p>4-40</p>  <p>6-32</p>	<p><b>Washers</b></p>  <p>Flat 8 x 14mm</p>  <p>Fiber #6</p>  <p>Lockwasher #6</p>	<p><b>Binding posts</b></p>  <p>Black</p>  <p>Red</p>  <p>Binding post nut</p>  <p>Binding post lockwasher</p>	 <p>Knob</p>  <p>Rubber foot</p>  <p>Strain relief 2-wire</p>	 <p>Heat sink</p>  <p>Shrink tubing</p>

# CONSTRUCTION

## Introduction

The most important factor in assembling your XP-15K Regulated Variable Power Supply Kit is good soldering techniques. Using the proper soldering iron is of prime importance. A small pencil type soldering iron of 25 - 40 watts is recommended. **The tip of the iron must be kept clean at all times and well-tinned.**

## Solder

For many years leaded solder was the most common type of solder used by the electronics industry, but it is now being replaced by lead-free solder for health reasons. This kit contains lead-free solder, which contains 99.3% tin, 0.7% copper, and has a rosin-flux core.

Lead-free solder is different from lead solder: It has a higher melting point than lead solder, so you need higher temperature for the solder to flow properly. Recommended tip temperature is approximately 700°F; higher temperatures improve solder flow but accelerate tip decay. An increase in soldering time may be required to achieve good results. Soldering iron tips wear out faster since lead-free solders are more corrosive and the higher soldering temperatures accelerate corrosion, so proper tip care is important. The solder joint finish will look slightly duller with lead-free solders.

Use these procedures to increase the life of your soldering iron tip when using lead-free solder:

- Keep the iron tinned at all times.
- Use the correct tip size for best heat transfer. The conical tip is the most commonly used.

- Turn off iron when not in use or reduce temperature setting when using a soldering station.
- Tips should be cleaned frequently to remove oxidation before it becomes impossible to remove. Use Dry Tip Cleaner (Elenco® #SH-1025) or Tip Cleaner (Elenco® #TTC1). If you use a sponge to clean your tip, then use distilled water (tap water has impurities that accelerate corrosion).

## Safety Procedures

- **Always wear safety glasses or safety goggles to protect your eyes when working with tools or soldering iron, and during all phases of testing.** 
- Be sure there is **adequate ventilation** when soldering.
- Locate soldering iron in an area where you do not have to go around it or reach over it. Keep it in a safe area away from the reach of children.
- **Do not hold solder in your mouth.** Solder is a toxic substance. Wash hands thoroughly after handling solder.

## Assemble Components

In all of the following assembly steps, the components must be installed on the top side of the PC board unless otherwise indicated. The top legend shows where each component goes. The leads pass through the corresponding holes in the board and are soldered on the foil side.

**Use only rosin core solder.**

**DO NOT USE ACID CORE SOLDER!**

## What Good Soldering Looks Like

A good solder connection should be bright, shiny, smooth, and uniformly flowed over all surfaces.

1. Solder all components from the copper foil side only. Push the soldering iron tip against both the lead and the circuit board foil.

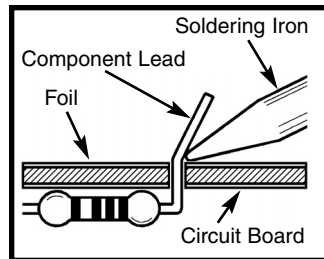

2. Apply a small amount of solder to the iron tip. This allows the heat to leave the iron and onto the foil. Immediately apply solder to the opposite side of the connection, away from the iron. Allow the heated component and the circuit foil to melt the solder.

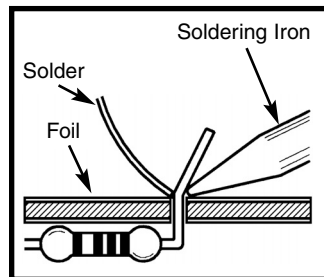

3. Allow the solder to flow around the connection. Then, remove the solder and the iron and let the connection cool. The solder should have flowed smoothly and not lump around the wire lead.

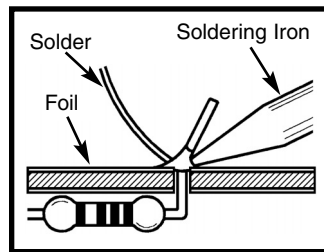

4. Here is what a good solder connection looks like.

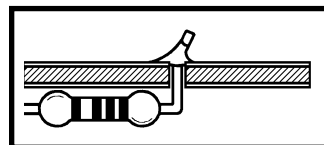

## Types of Poor Soldering Connections

1. **Insufficient heat** - the solder will not flow onto the lead as shown.

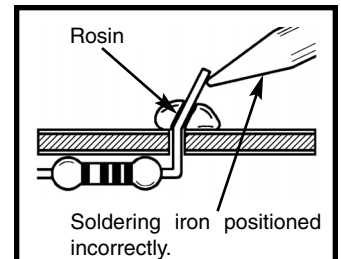

2. **Insufficient solder** - let the solder flow over the connection until it is covered. Use just enough solder to cover the connection.

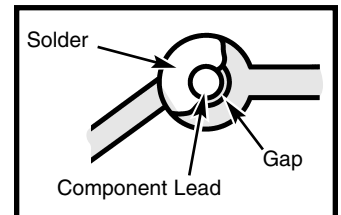

3. **Excessive solder** - could make connections that you did not intend to between adjacent foil areas or terminals.

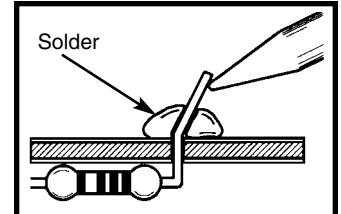

4. **Solder bridges** - occur when solder runs between circuit paths and creates a short circuit. This is usually caused by using too much solder. To correct this, simply drag your soldering iron across the solder bridge as shown.

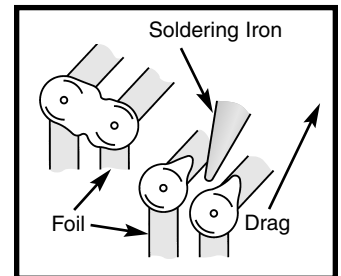

## MOUNTING THE TRANSFORMER & BINDING POSTS

- ❑ Peel the backing off of the label and place it onto the case top, while carefully lining up the holes as shown in Figure A. The label should fit snug within the indentation in the case.
- ❑ Install the binding posts with the colors in the order as shown in Figure B. Insert the post into the hole and fasten it with the nut and lockwasher. Tighten down the nut with pliers.
- ❑ Install the transformer as shown in Figure B. Use a 6-32 x 3/8" screw, #6 lockwasher, 6-32 nut, and two #6 fiber washers on each side to fasten in place as shown.
- ❑ Cut the red wires on the transformer off close to the transformer.

**These wires will be used on the PC board.**



**Figure A**

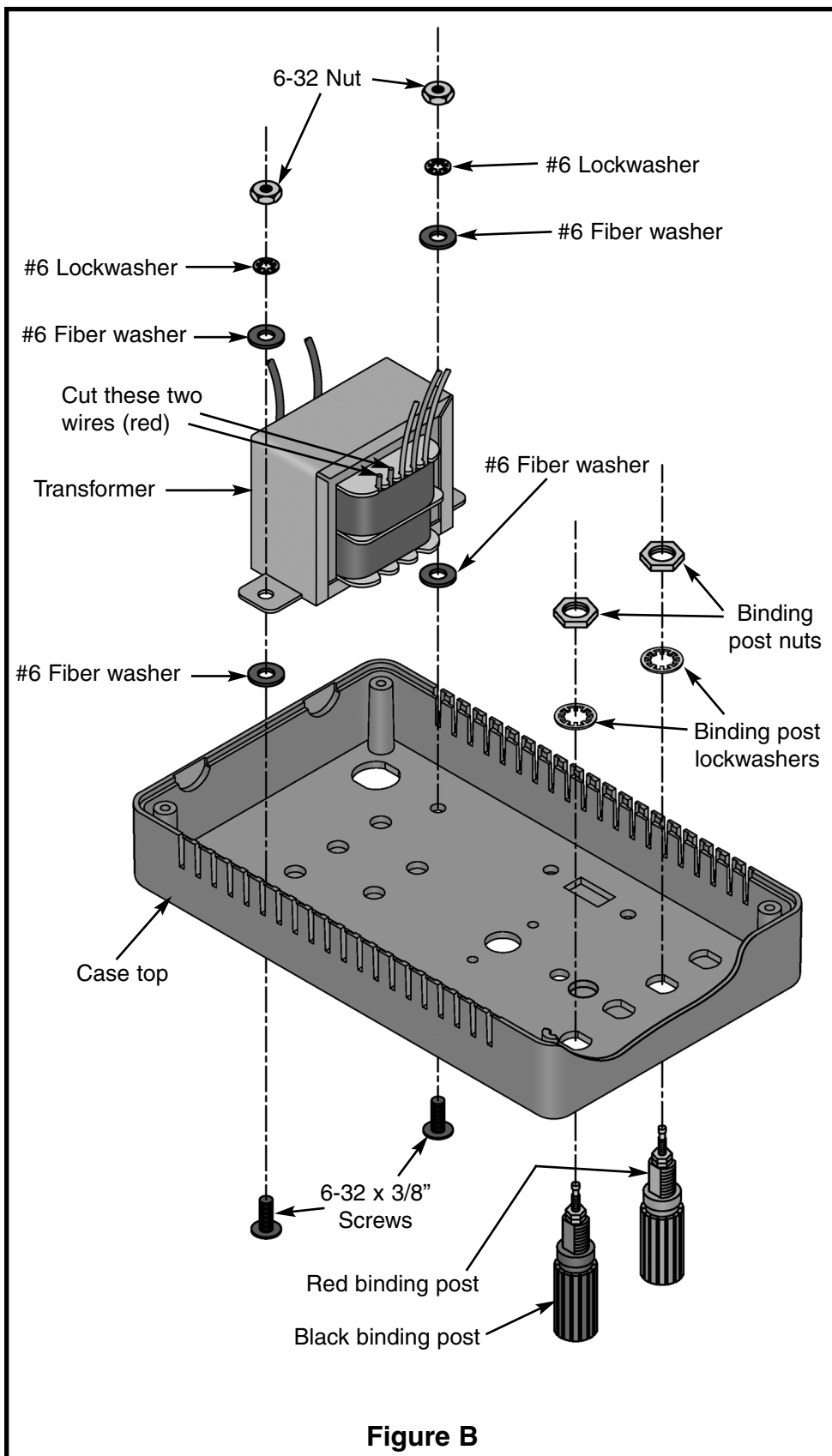
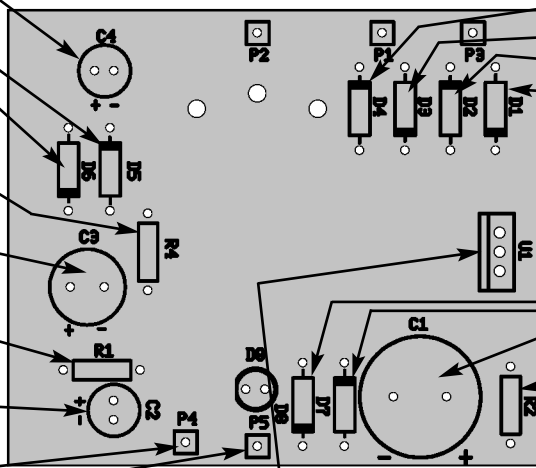

**Figure B**

# ASSEMBLE COMPONENTS TO THE PC BOARD

Place a check mark  in the box provided next to each step to indicate that the step is completed.

- C4 - 220 $\mu$ F Electrolytic (see Figure D)
  - D5 - 1N4001 Diode
  - D6 - 1N4001 Diode (see Figure C)
  - R4 - 2.2k $\Omega$  5% 1/4W Res. (red-red-red-gold)
  - C3 - 470 $\mu$ F Electrolytic (see Figure D)
  - R1 - 2.2k $\Omega$  5% 1/4W Res. (red-red-red-gold)
  - C2 - 4.7 $\mu$ F Electrolytic (see Figure D)
  - P4 - 3" Red wire
  - P5 - 3" Red wire
- Cut two 3" wires from the cut-off red transformer wires and strip 1/4" of insulation off of each side.



- D4 - 1N4001 Diode
- D3 - 1N4001 Diode
- D2 - 1N4001 Diode
- D1 - 1N4001 Diode (see Figure C)
- D8 - 1N4001 Diode
- D7 - 1N4001 Diode (see Figure C)
- C1 - 2,200 $\mu$ F Electrolytic Cap. (see Figure D)
- R2 - 150 $\Omega$  5% 1/4W Res. (brown-green-brown-gold)
- U1 - LM317 Regulator (see Figure E)

## Figure C

Diodes have polarity. Be sure to mount them with the band going in the same direction as marked on the PC board.

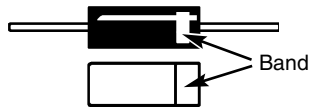

## D9 - LED

- Mount the LED to the copper side of the PC board, spaced 3/8" off the board, with the flat side in the same direction as shown in Figure F.

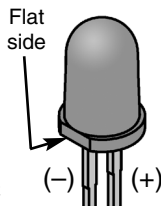

## R3 - 2k $\Omega$ Potentiometer

- Mount the potentiometer to the copper side of the PC board as shown in Figure F. Insert the the pins through the holes so the body sits flat against the PC board, then solder in place.

## Figure D

These capacitors are polarized. Be sure to mount them with the "+" lead in the correct hole as marked on the PC board. Also, the negative lead of a radial electrolytic is shorter than the positive one.

**Warning:** If the capacitor is connected with incorrect polarity it may heat up and either leak or cause the capacitor to explode.

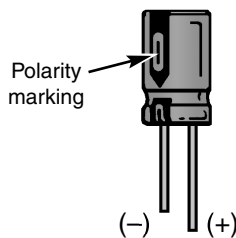

## Figure E

Mount the regulator as shown, with the metal backing in the same direction as the marking on the PC board. Attach the heat sink using a 4-40 x 1/4" screw and 4-40 nut.

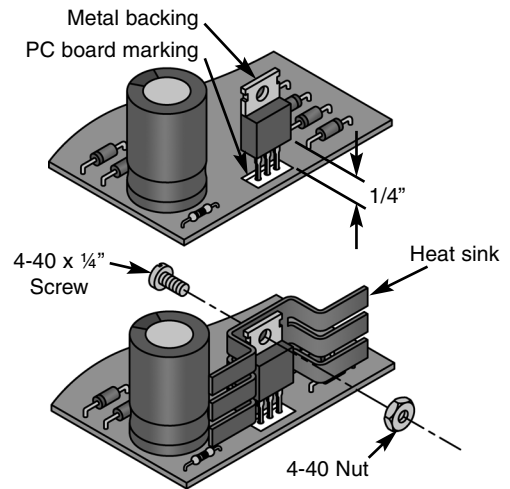

## Figure F

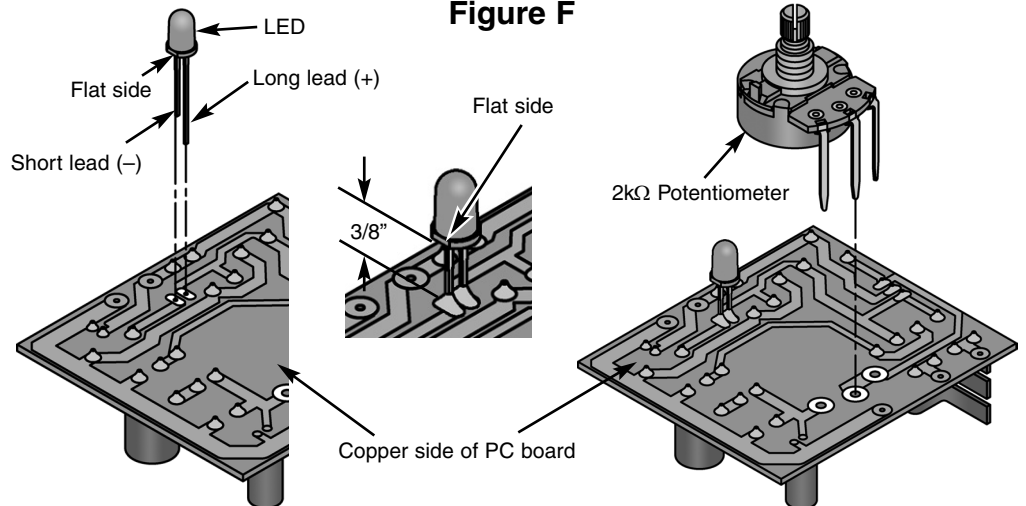

## WIRING

Install the following wires as shown in Figure G.

- ❑ Cut the blue and both yellow transformer wires so that they are 4". Strip 1/4" insulation off the ends.
- ❑ Solder one of the yellow wires from the transformer to PC Board P1 and the other to P3.
- ❑ Solder the blue wire from the transformer to the PC board hole P2.
- ❑ Solder the red wire from the P5 to the end of the the red binding post.
- ❑ Solder the red wire from the P4 to the end of the the black binding post.
- ❑ Install the PC Board into case by lining up the shaft of the pot and the LED with the holes in the case, and then pressing PC board into place. Flip the case around and install the 8 x 14mm flat washer and 7mm nut as shown in Figure H.
- ❑ Turn the shaft on the pot fully counterclockwise. Push the knob onto the shaft so that the line on the knob lines up with the end of the circle on the front panel as shown in Figure I. If the knob is loose on the pot shaft, insert a screwdriver in to the slot and expand the slot slightly. If the knob has a set screw, tighten the set screw located on the side of the knob.

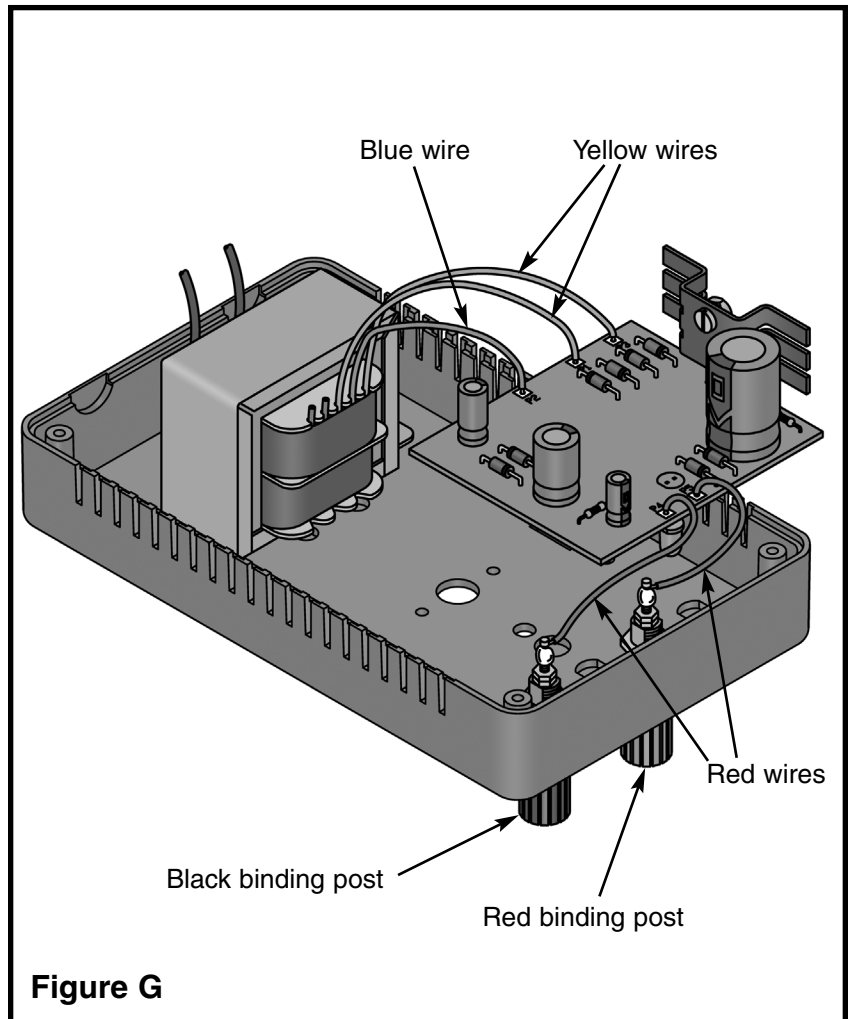

Figure G

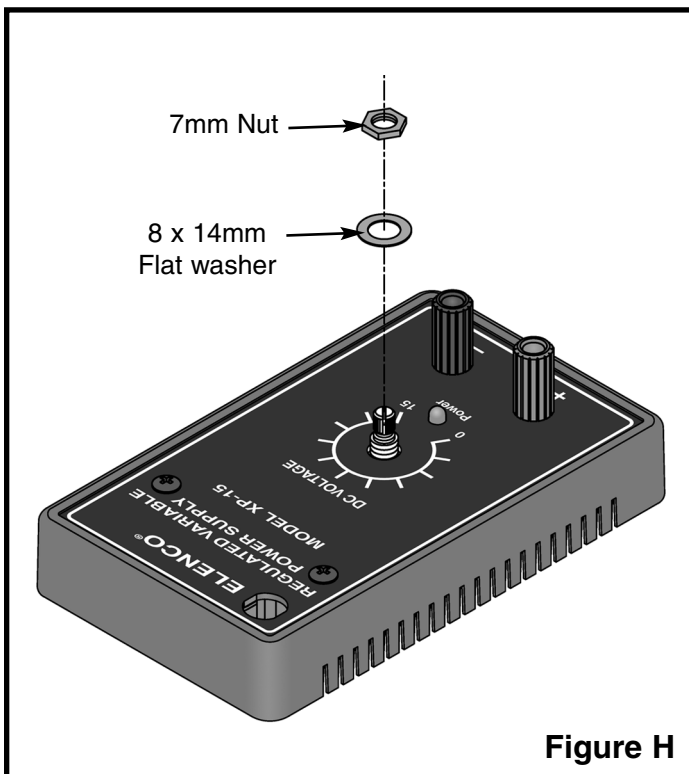

Figure H

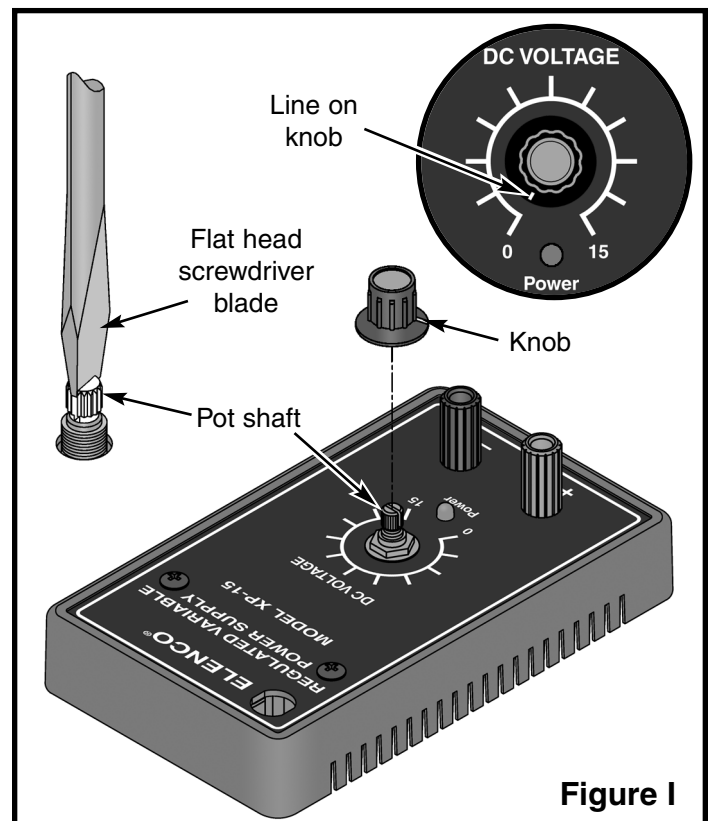
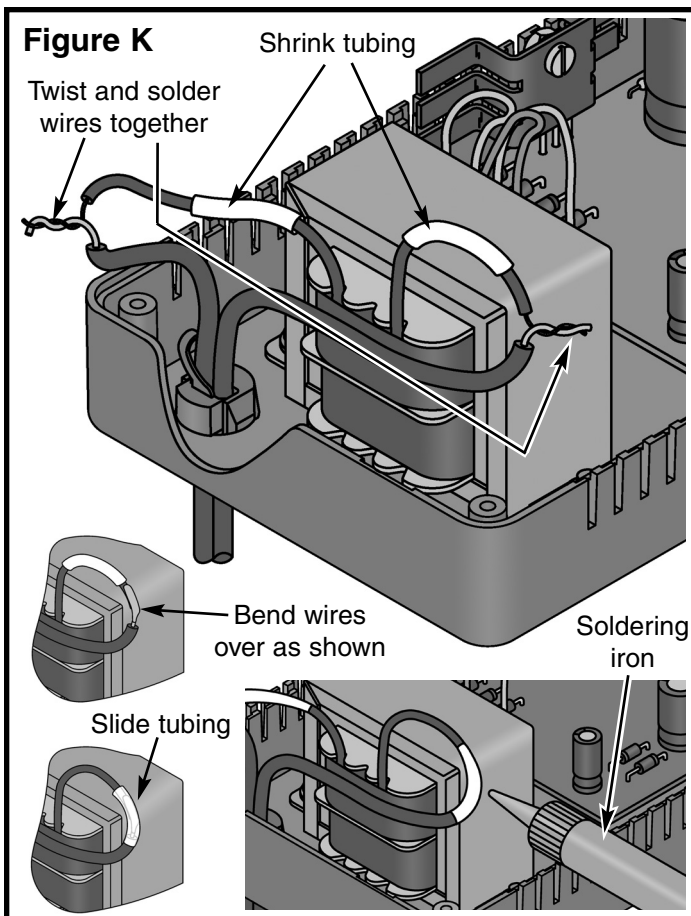
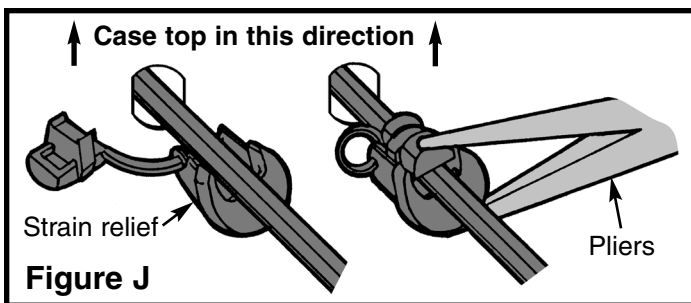

Figure I

## LINE CORD ASSEMBLY

Install the following wires as shown in Figure K.

- ❑ Cut the two black wires from the transformer to 1½". Strip ¼" of insulation off of each wire.
- ❑ Feed 2" of line cord into the hole of the chassis. Place the line cord in the slot of the strain relief and squeeze the two sections together with pliers. Then, insert the strain relief into the hole, as shown in Figure J.
- ❑ Separate the two line cord wires. Place 1" of shrink tubing over each black transformer wire. Twist and solder the line cord wires to the black transformer wires as shown in Figure K.
- ❑ Slide the shrink tubing up to cover the solder joints. Shrink the tubing with the heat from your soldering iron. **BE CAREFUL NOT TO TOUCH THE SHRINK TUBING OR WIRES WITH THE IRON.**



## FINAL ASSEMBLY

- ❑ Remove the backing from each rubber foot and place them in the locations shown in Figure L.
- ❑ Assemble the top and bottom case sections and fasten with four 2.8 x 8mm self-tapping screws as shown in Figure L. Make sure the slots on the side line up with one another.

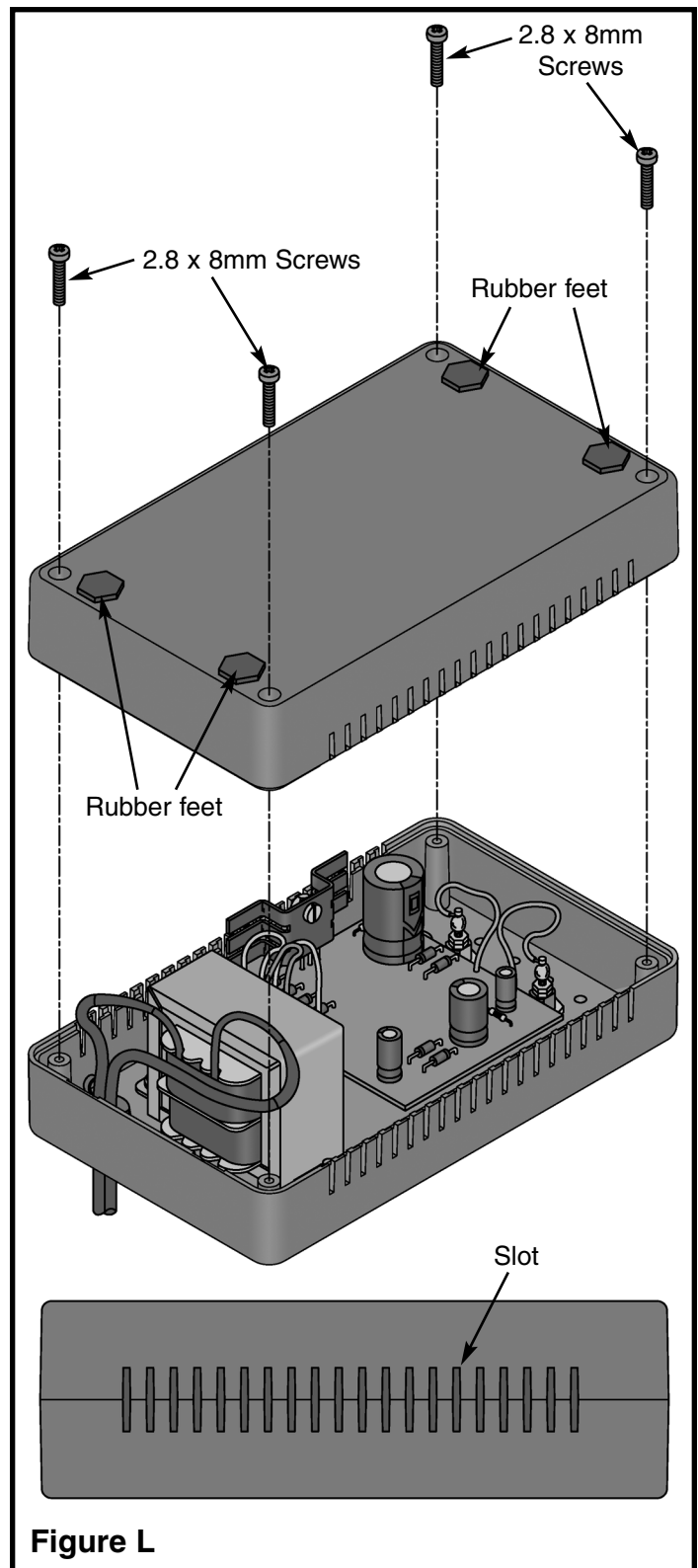



## TESTING THE XP-15K POWER SUPPLY

Testing the XP-15K Power Supply is very simple. Before applying power to the unit, be sure that all of the wiring and soldering is firm. If so, obtain a digital voltmeter. Apply power to the XP-15K and vary the voltage control knob.

Next, short the output of the supply. It should turn off and recover when the short is removed. If you have a  $4.7\Omega$  1 watt resistor, set the voltage to 1.4 volts and place it across the output terminals. The output of the supply should not change more than 0.1 volts.

Set the output voltage to 15 volts and place a  $75\Omega$  5 watt resistor across the output terminals. Again, the output should not change by more than 0.1 volts. In making these tests, the voltmeter leads should be clipped directly to the output terminals and not to the load leads. This is to prevent errors due to voltage drop in the load leads.

Should any of these tests fail, refer to the troubleshooting guide.

## CIRCUIT DESCRIPTION

### INTRODUCTION

The XP-15K Power Supply features an output voltage variable from 0 to 15V at 0.3 ampere maximum current. The voltage is regulated to within 0.1V when going from no load to full load. Varying the input AC voltage from 110 to 130V will have practically no effect on the output voltage. This is because of the specially designed IC circuit used in

the XP-15K. Severe overloading or even short circuiting the output will not damage the supply. Special turn-off circuits in the IC sense the overload and turn off the output.

Figure 1 shows a simplified circuit diagram of the power supply. It consists of a power transformer, a DC rectifier stage and the regulator stage.

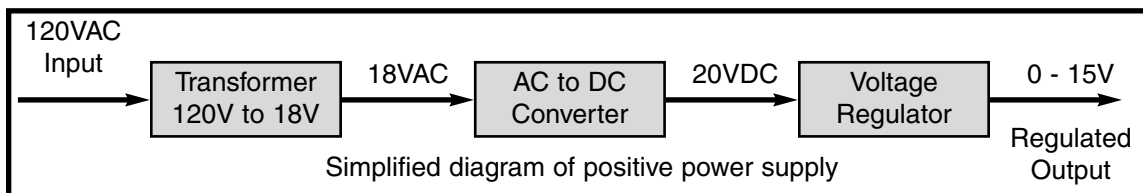

Figure 1

### TRANSFORMER

The transformer T1 serves two purposes. First, it reduces the 120VAC input to 18VAC to allow the proper voltage to enter the rectifier stage. Second, it isolates the power supply output from the 120VAC line. This prevents the user from dangerous voltage shock should they be standing in a grounded area.

### AC to DC CONVERTER

The AC to DC converter consists of diodes D1 and D3 and capacitor C1. Transformer T1 has two secondary windings which are 180 degrees out of phase. The AC output of each winding is shown in Figure 2A and 2B.

Diodes are semiconductor devices that allow current to flow in one direction. The arrow in Figure 3 points to the direction that the current will flow. Only when the transformer voltage is positive will current flow through the diodes. Figure 3 shows the simplest possible rectifier circuit. This circuit is known as a half wave rectifier. Here, the diode conducts only half the time when the AC wave is positive as shown in Figure 2C. Use of this circuit is simple but inefficient. The big gap between cycles requires much more filtering to obtain a smooth DC voltage.

By the addition of a second diode and transformer winding, we can fill in the gap between cycles as shown in Figure 4. This circuit is called full wave rectification.

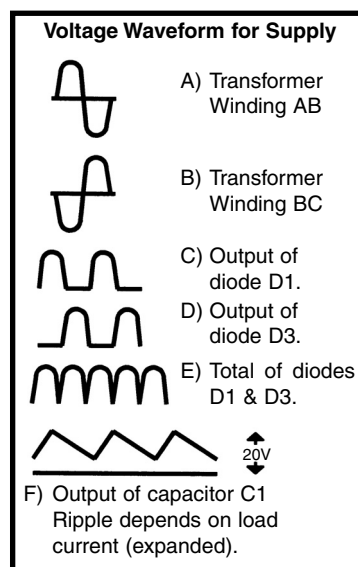

Figure 2

Each diode conducts when the voltage is positive. By adding the two outputs, the voltage presented to capacitor C1 is more complete, thus, easier to filter, as shown in Figure 2F. When used in 60 cycles AC input power, the output of a full wave rectifier will be 120 cycles.

Capacitor C1 is used to store the current charges, thus smoothing the DC voltage. The larger the capacitor, the more current is stored. In this design, a 2,200 $\mu$ F capacitor is used, which allows about 2 volts of AC ripple when one half amp is drawn.

In practice, the current through the diodes is not as shown in Figure 2E. Because capacitor C1 has a charge after the first cycle, the diode will not conduct until the positive AC voltage exceeds the positive voltage in the capacitor. Figure 5 shows a better picture of what the current flow looks like, assuming no loss in the diode.

It takes a few cycles for the voltage to build up on the capacitor. This depends on the resistance of the winding and diode. After the initial start-up, there will be a charge and discharge on the capacitor

depending on the current drawn by the output load. Remember, current only flows through the diode when the anode is more positive than the cathode. Thus, current will flow in short bursts as shown in Figure 5C.

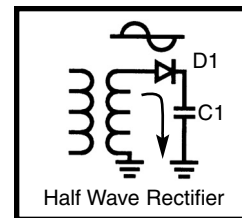

Figure 3

The DC load current may be one ampere, but the peak diode current may be three times that. Therefore, the diode rating must be sufficient to handle the peak current. The 1N4001 has a peak current rating of 10 amps.

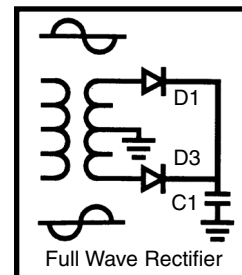

Figure 4

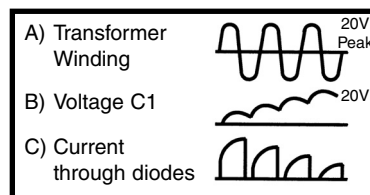

Figure 5

## REGULATOR CIRCUIT

The regulator circuit in the Model XP-15K Power Supply consists of a LM317 integrated circuit. This IC is specially designed to perform the regulation function. Figure 6 shows a simplified circuit of how the LM317 IC works.

Transistors Q1 and Q2 form a circuit known as a differential amplifier. Transistor Q1's base is connected to a stable 1.5V reference voltage. The base of Q2 is connected to the regulator output circuit through a voltage divider network. The collector of transistor Q2 is connected to a current source. This basically is a PNP transistor biased to draw about 1mA current. Transistor Q2 sees the current source as a very high resistor of about 1 meg ohms. Thus, the gain of transistor Q2 is very high.

Transistor Q5 is called the pass transistor. It controls the current reaching the output. Transistors Q3 and Q4 are emitter followers. Their function is to raise the impedance of the pass transistor. Note that transistor Q2, Q3, Q4, Q5 and resistor R1 form a closed loop. Also, note that the feedback to the base of Q2 is negative, that is, the output at emitter Q5

goes negative. Now, if the 1.25V output voltage goes down because of current drain at the output, the base of Q2 will drop, forcing the collector voltage of Q2 to go higher. This will bring the output voltage back to 1.25V. This is the basis of all negative feedback regulators.

Another feature of the LM317 regulator is to protect the IC against overload and output shorts. If the IC is overloaded, the junction will overheat. A transistor will sense this overheating and shut down transistor Q5.

The LM317 IC is basically a 1.25V regulator. To be able to vary the output 0 - 15V, we stack the IC on the negative 1.25VDC voltage as shown in Figure 7. When R3 equals 0, the output voltage is 0 volts.

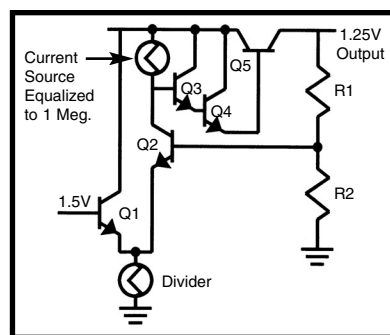

Figure 6

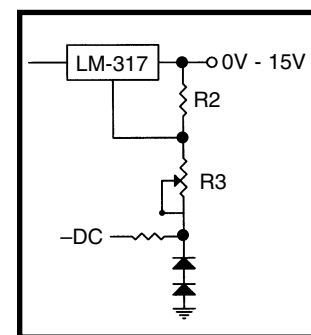

Figure 7

---

## TROUBLESHOOTING GUIDE

Consult your instructor or contact ELENCO® if you have any problems. **DO NOT** contact your place of purchase as they will not be able to help you.

### LED Not Lit

- 1) Check transformer and line cord.
- 2) Check for 20VDC at the cathode of D1.
- 3) LED in backwards or defective.

### No Output Voltage

- 1) Check AC voltage across points P1 & P2 or P2 & P3. It should read about 18VAC.
- 2) Measure voltage at the output of D1 and D3. It should read about 20VDC. If not, then check D1, D3, C1, U1, R2, R3, D7, and D8.

### Poor Regulation

- 1) Check AC ripple at the input of the regulator. It should be less than 2.5V.
- 2) If ripple is higher, check diodes D1, D3, and the filter of capacitor C1.

Copper Side of PC Board

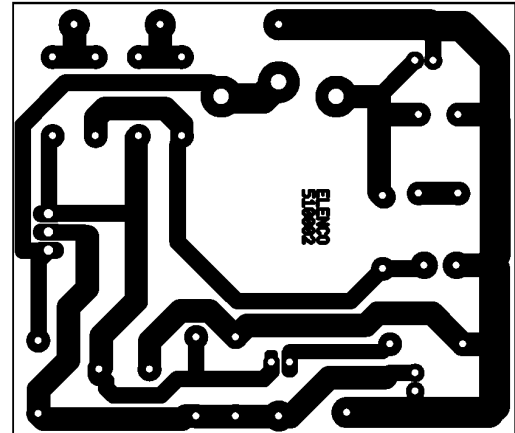

---

## QUIZ

1. AC voltage is supplied to the rectifier stages by the . . .
  - A. step up transformer.
  - B. step down transformer.
  - C. 1 to 1 transformer.
  - D. AC to DC transformer.
2. The secondary windings of the transformer are . . .
  - A. 90° out of phase.
  - B. 180° out of phase.
  - C. 270° out of phase.
  - D. 320° out of phase.
3. Diodes allow current to flow . . .
  - A. when the anode is more negative than the cathode.
  - B. when the cathode is more positive than the anode.
  - C. in one direction.
  - D. when a negative or positive voltage is on the anode.
4. What circuit is more efficient for rectifying AC to DC?
  - A. Hartley oscillator.
  - B. Half wave.
  - C. Schmitt trigger.
  - D. Full wave.
5. The DC voltage is smoothed by using a . . .
  - A. half-wave rectification circuit.
  - B. small value capacitor with a high voltage value.
  - C. Large value capacitor.
  - D. 90° out of phase rectification circuit.
6. An inefficient rectification circuit usually contains . . .
  - A. large gaps between cycles.
  - B. twice the AC voltage needed.
  - C. more diodes.
  - D. all of the above.
7. The maximum current that a diode can handle is determined by . . .
  - A. the transformer's current rating.
  - B. the amount of AC ripple.
  - C. three times the diode rating.
  - D. peak current rating.
8. The LM317 will shut down when . . .
  - A. the output voltage is too high.
  - B. no current is being drawn.
  - C. the junction overheats.
  - D. the output voltage drops to 1.25V.
9. The LM317 regulator contains . . .
  - A. a pass transistor.
  - B. a constant current source.
  - C. a differential amplifier.
  - D. all of the above.
10. The LM317 is . . .
  - A. a positive voltage regulator.
  - B. a 6.25V regulator.
  - C. a 2.5V regulator.
  - D. a negative voltage regulator.

# SCHEMATIC DIAGRAM

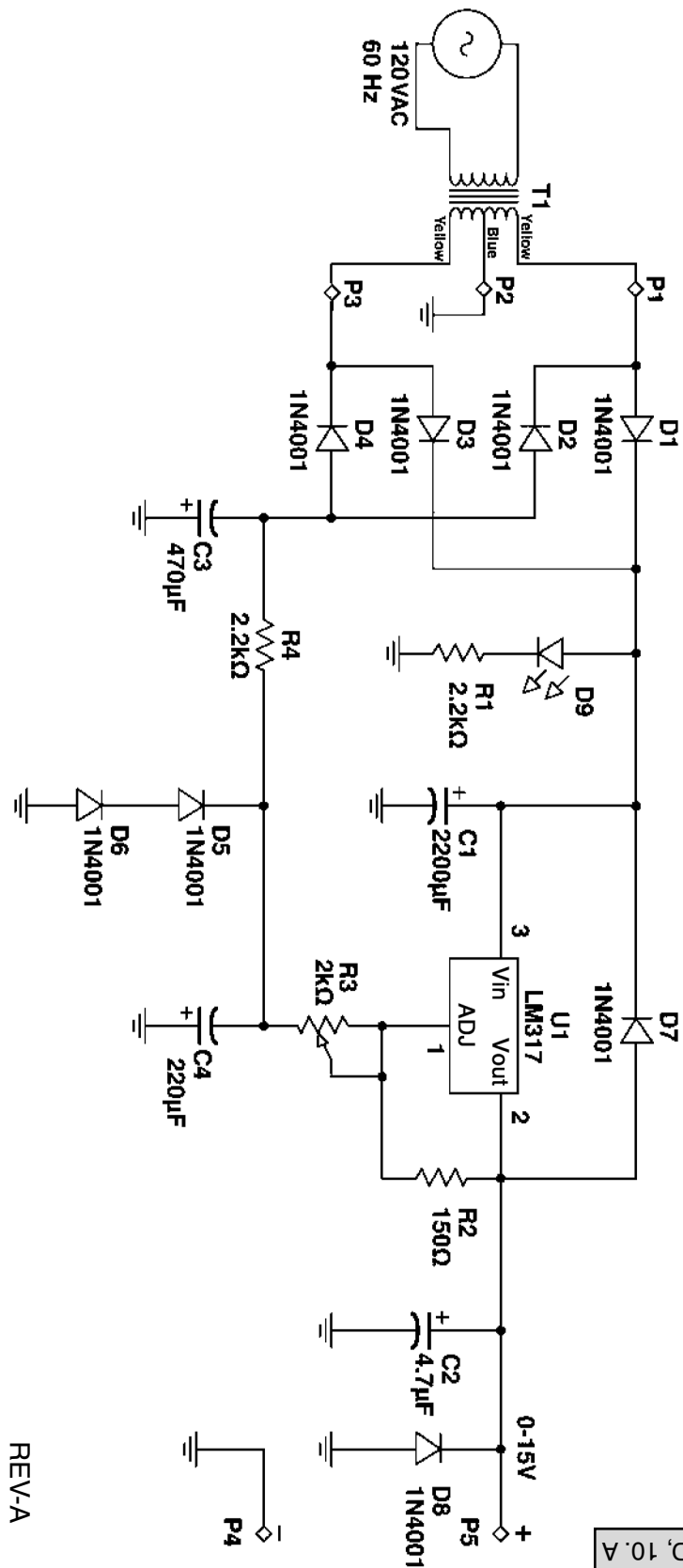

REV-A

Answers: 1. B, 2. B, 3. C, 4. D, 5. C, 6. D, 7. D, 8. C, 9. D, 10. A

**ELENCO®**

150 Carpenter Avenue • Wheeling, IL 60090  
 (847) 541-3800 • Website: [www.elenco.com](http://www.elenco.com) • e-mail: [elenco@elenco.com](mailto:elenco@elenco.com)