

GRFICO

MODELO 1330 A

ESTABILIZA  
CORTOCIR  
AJUSTAR

30-40



RED

RED

13 V



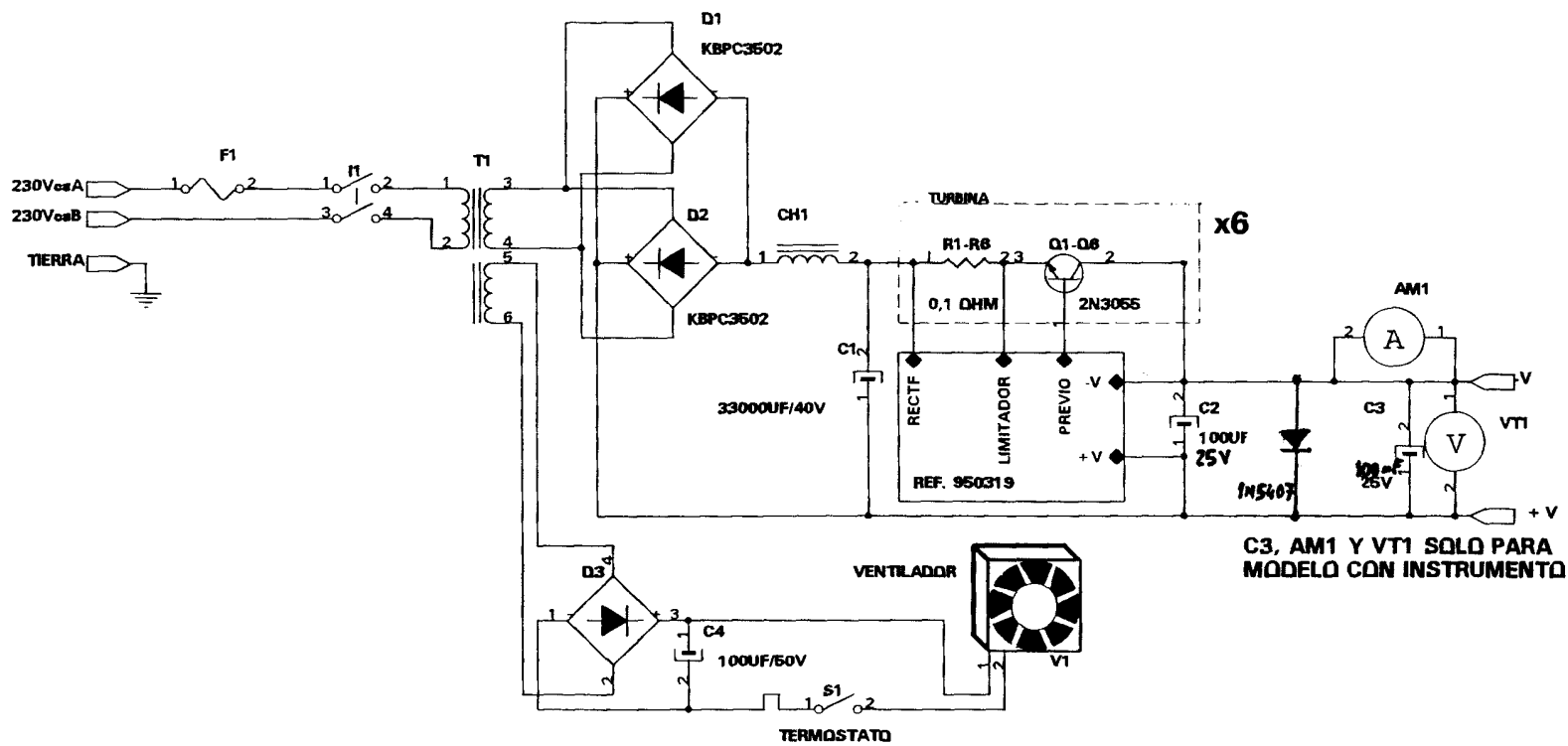

<b>ORICO</b>	IM-TC-08	ESQUEMA:	C.IMPRESO:
	G1330AM	CODIGO PROYECTO:	APLICACION:
JORDI RUIZ	G1330A-001	JC BARCELO	<b>GENERAL</b>
REALIZADO:	REVISADO:	FIRMA:	HOJA TIPO:
FIRMA:	JORDI RUIZ	FECHA:	A4
FECHA:	15-4-1999	FECHA:	EDICION:
			1
			HOJA 1 DE 1

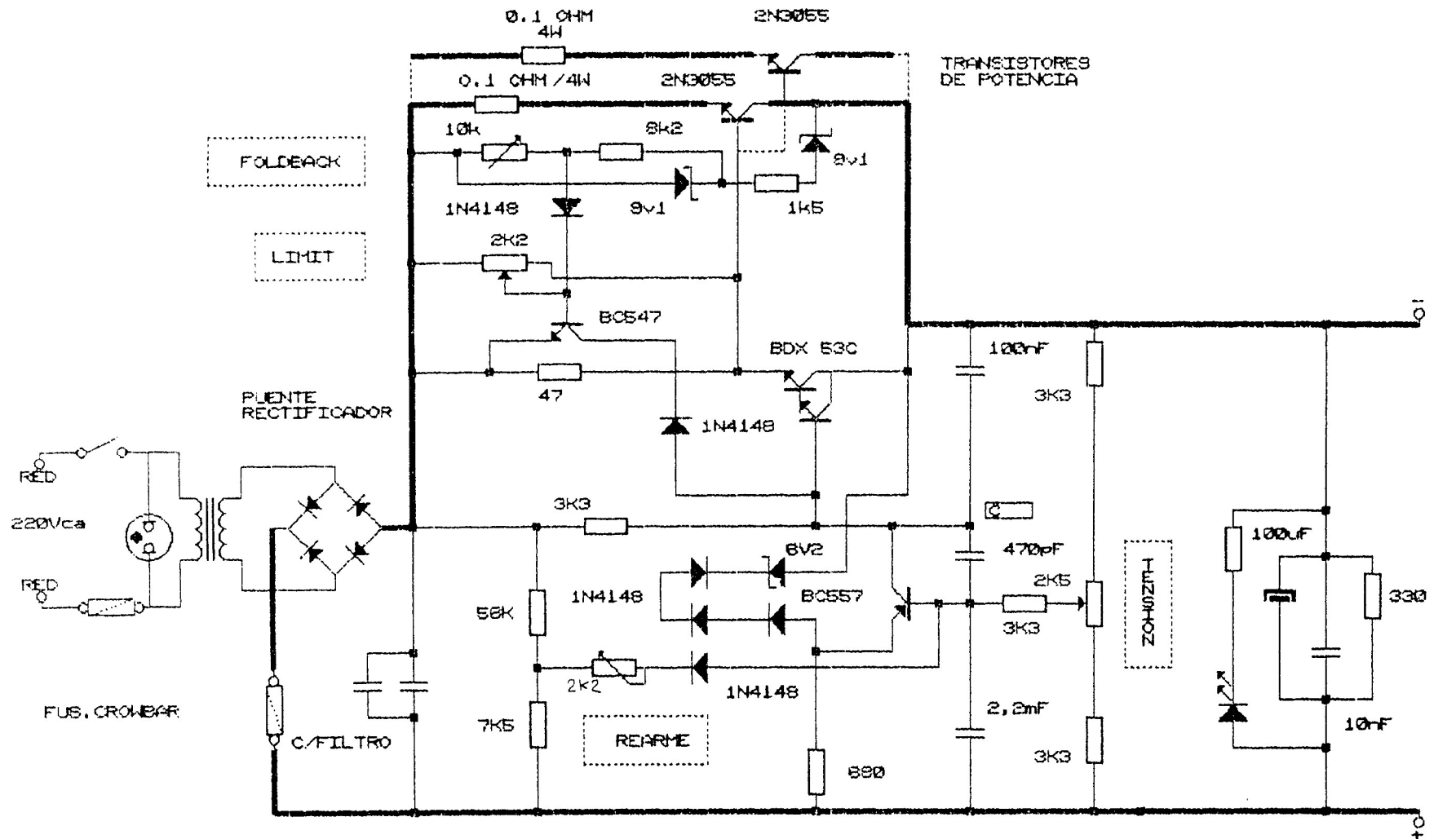

ESQUEMA GENERAL PARA LOS MODELOS:

CAPACIDAD DE FILTRO: 1000uF POR AMPERIO

TRANSISTORES DE POTENCIA: 1 POR CADA 6 AMPERIOS

PUNTE RECTIFICADOR: UN 60% SUPERIOR A LA INTENSIDAD NOMINAL

## EA5AEL 2016

GRELCO, S.A.

TECNIC: JOAN CARLES

Size Document Number

REV

A

FA 30

Date:

May 1, 1993

Sheet

of

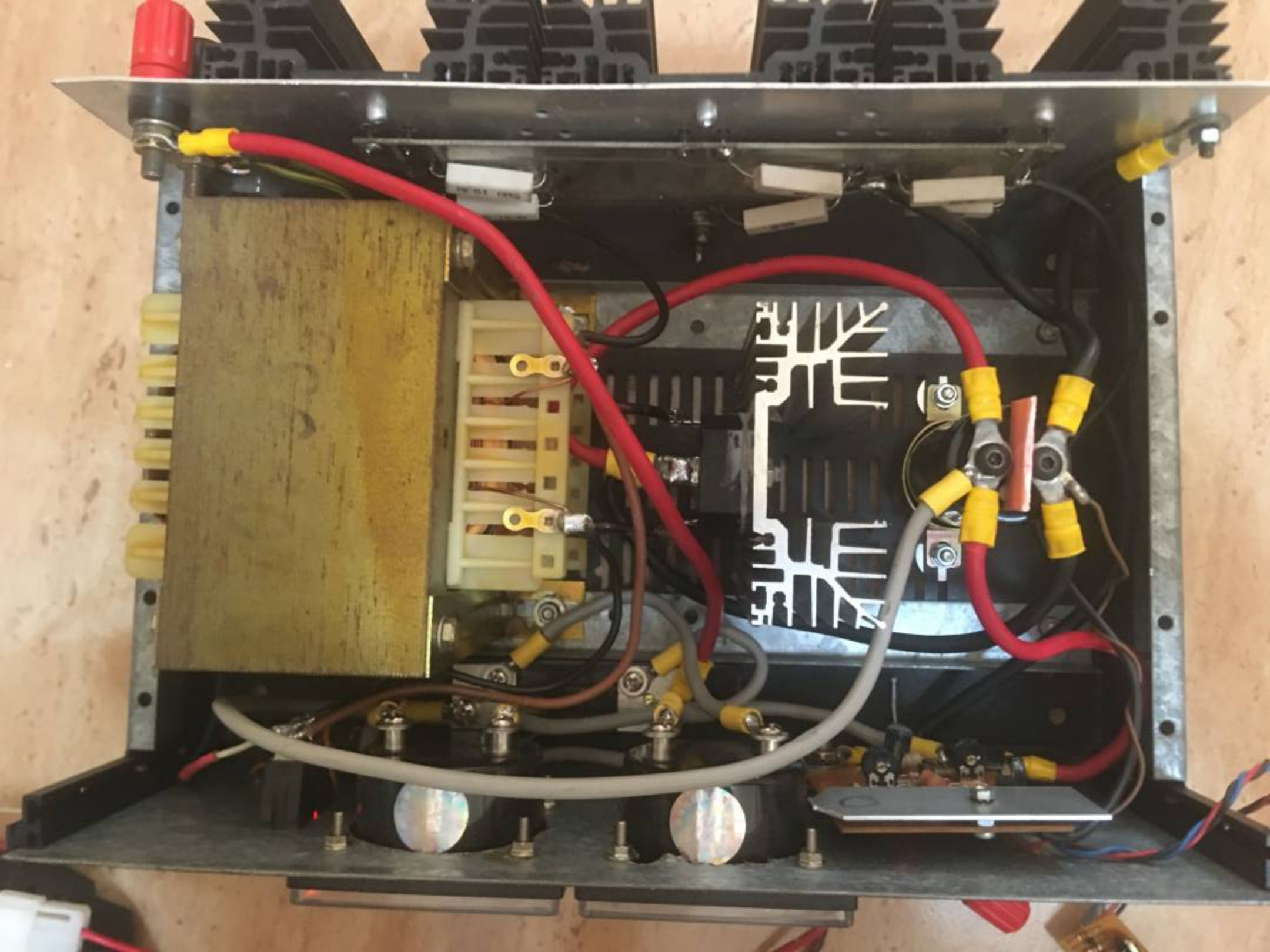

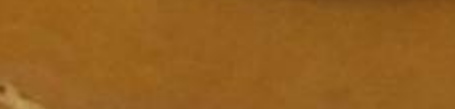
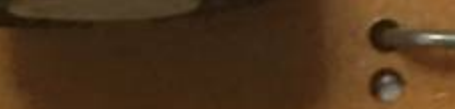
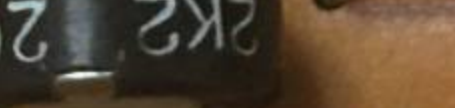
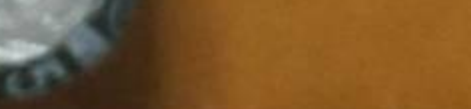
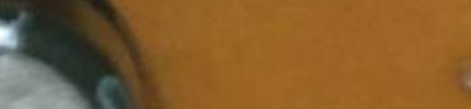
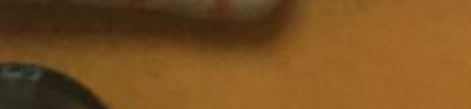
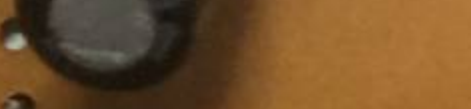

10K 203



GRELCO

CF 30

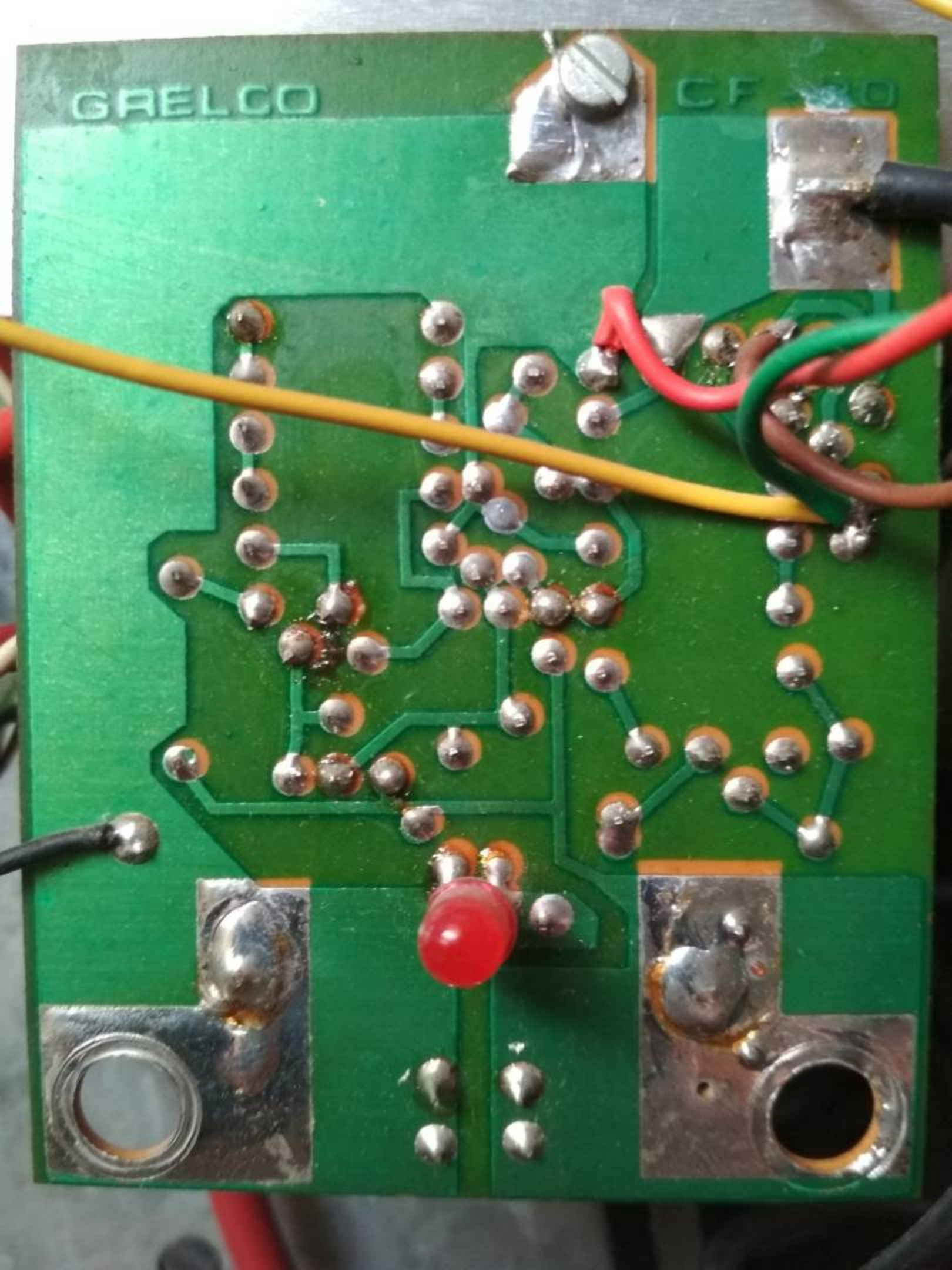

7777  
**SALCO**  
M.F.  
V.T.  
Borna  
TIPO FESAL  
MADE IN SPAIN

33.00

