

VLNA

A Very Low Noise (pre)-Amplifier for the UHF 70cm to 9cm bands

Sam Jewell, G4DDK



Introduction

This paper describes the current build (September 2013) of the G4DDK VLNA preamplifiers. There are four versions of the VLNA amplifier. These cover the four main amateur radio UHF bands of 70, 23, 13 and 9cm. Intermediate frequency ranges, such as 1420MHz (Hydrogen line), 1575MHz (GPS) 1700MHz (Met sats) and 2400MHz (ISM) are covered by slight variations on each of the basic preamplifiers.

The original VLNA was designed for 23cm only. Further development showed that the VLNA was also capable of giving excellent results at 13cm & 9cm and, later, 70cm, with just a few changes to component values. All four versions of the VLNA share the same PCB and bias component values. RF path component values are individually optimised

for each of the four bands. In addition, the 9cm version also uses a different type of RF absorber material in the case lid, although this may not be critical from recent tests.

The heading photo shows a VLNA for 23cm (known as a VLNA23). The VLNA70, VLNA13 and VLNA9 look very similar..

The original VLNA design was introduced at the German Weinheim Tagung meeting in 2007. Since then it has undergone several upgrades including changes to the PCB design and a change of front end GaAs FET, leading to the publication of the VLNA2 in 2010 and the VLNA2+ in 2011. Table 1 shows the main developments of the amplifier.

All versions of the preamplifier are now known as VLNA with 70, 23, 13 or 9 as the suffix to denote band coverage

Design	Introduced	Development
VLNA	September 2007	Original version
VLNA2	July 2010	Improved noise figure and stability
VLNA2+	January 2011	Improved input return loss. Alternative input FET
VLNA70	July 2011	A high stability 70cm version introduced
VLNA70, 23, 13, 9	August 2011	Name change introduced

Table 1. development of the various VLNA versions.

VLNA70

This is the most recent version of the preamplifier. Whilst the noise figure is not as low as some others claim to achieve, for all but the most demanding of EME systems, <0.4dB is adequate at 432MHz. High gain is featured, achieving typically 40dB and input return loss of typically 10-14dB. With careful adjustment, and some trade off again noise figure, input return loss of up to 20dB can be achieved. The high gain can be an advantage where higher loss receiver cables are used. Second stage contribution is often negligible, due to the high gain of the preamplifier.

VLNA23

Although the original VLNA was based on the designs of WD5AGO and others, the later improvements are largely due to the efforts of Sergie, RW3BP, [1] who managed to achieve claimed noise figures below 0.2dB together with good input return loss and high stability.

Inspired by Sergie's work I made a number of changes to the original 23cm VLNA kit to try to duplicate his results. Whilst the kit version of the modified 23cm VLNA does not claim to reach the full performance claimed by RW3BP, it shows considerable performance improvement over the original design and with a little extra effort from the kit-builder may be able to approach the performance seen by Sergie.

At 23cm a noise figure of below 0.3dB is now readily achieved by following the construction details in this article without the critical alignment that was required for the original VLNA. The pre-amplifier is stable, even with the input open circuit. With the changes introduced with the most recent VLNA23 build input return loss is typically 6-10dB and has been measured at better than 12-14dB in a number of samples.

The gain depends strongly on the setting of input matching inductor L1. A typical gain of 37.5dB is achieved but is a (small) trade-off against noise figure.

VLNA13

By incorporating several of Sergie's modifications I have been able to achieve a worthwhile improvement in the performance of the VLNA13. A noise figure of <0.3dB at 28dB gain together with an input return loss of typically 9 - 11dB can be achieved.

VLNA9

The VLNA9 gives a noise figure of better than 0.5dB (0.45 typical) at a gain of 27dB. A GaAs FET, type MGF4941AL is now used in the VLNA9 to achieve the improved performance.

Band	Noise figure	Gain
70cm	<0.4dB	~41dB
23cm	<0.3dB	~37.5dB
13cm	<0.3dB	~29dB
9cm	<0.5dB	~29dB

Table 2 Performance table

Circuit description - All bands

A low noise Mitsubishi MGF4919G HEMT is used in the critical low noise front end. An Avago ATF54143 is used in the second stage because it is capable of simultaneously providing low noise and a very high dynamic range. Alternatively, the MGF4941AL can be used in place of the MGF4919 at 9cm.

Part	Value	Comments	Package
C1	See table 4		C-EUC0805
C2, C8, C11	8.2pF		C-EUC0603
C3, C5, C6, C12	220pF		C-EUC0603
C4	See table 4		C-EUC0603
C7	See table 4		C-EUC0805
C9	1nF		C-EUC0603
C10	10nF		C-EUC0603
C13	See table 4		C-EUC0603
C14, C15, C16, 17	10uF 25V		Tantalum
C18	1500pF		Feedthrough
R1, R5	51R		R-EU_R0603
R3		Replaced by L10	
R4	220R		R-EU_R0603
R12	150R		R-EU_R0603
R6	10k		R-EU_R0603
R7, R10	1k		R-EU_R0603
R11	1k5		R-EU_R0603
R14	1k		R-TRIMM
R8	10R		R-EU-R1206
R9	22R		R-EU-R1206
R13	4k7		R-EU-R0603
R15	10R		R-EU-R0603
L1/L2/L3/L4/L5	Length of enameled covered wire. 0.315mm		See details below.
L6, L9, L10	See table 4	L10 replaces R3	SMD0603
FB1 (70cm only)	Ferrite bead	Fair-Rite 43 2673000501	2mm x 1.65mm
Tr1	MGF4919	GaAs FET	84
Tr2	ATF5414 3	GaAs FET	SOT343
Tr3	BC807	PNP transistor	SOT23
IC1	78M05	5V regulator	D-Pak
IC2	ICL7660	DC-DC Converter	SOIC-8
D1	S1A	Protection diode	SMD
CX1, CX2	2 Hole SMA		
T1, 2	Absorber	Cut from single 50 x 30mm	

and 3	-ARC 10017	piece	
Box	4 piece tinplate		74x37 x30mm

Table 3 Component list for the VLNA

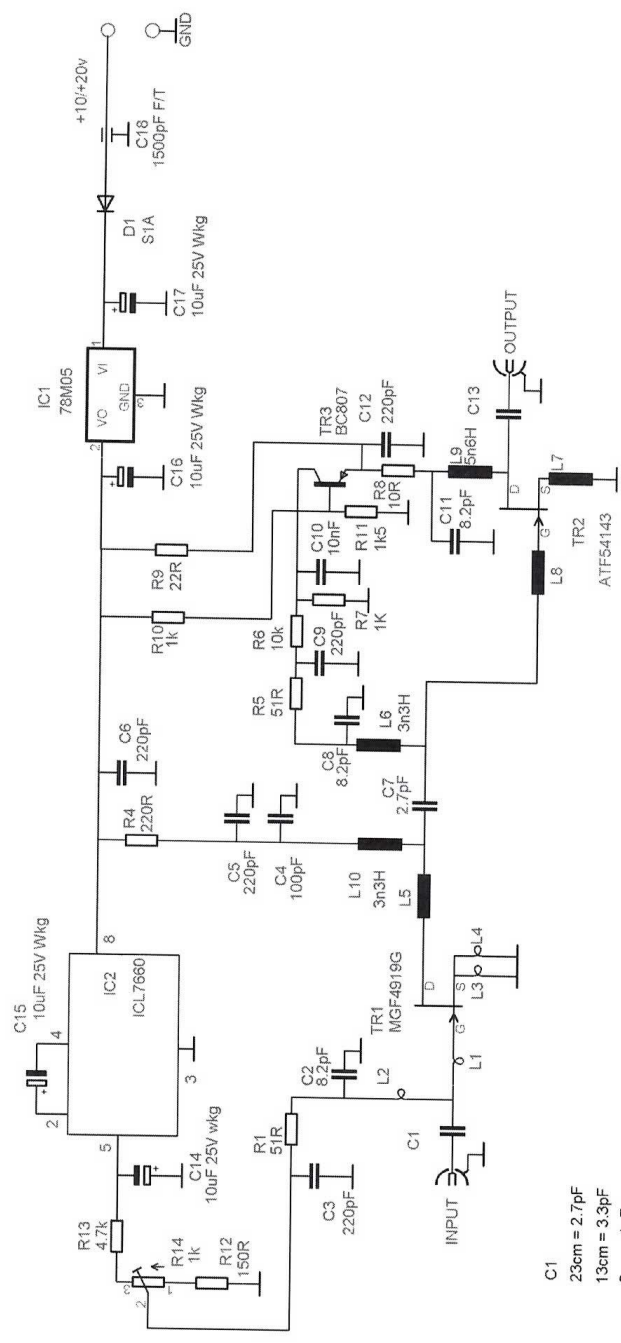

- C1
23cm = 2.7pF
13cm = 3.3pF
9cm = 1pF
- C13
23cm = 8.2pF
13cm, 9cm = 4.7pF
- L1
23cm = 3.75 turns
13cm = 13mm hairpin
9cm = 9mm hairpin

Note: R3 no longer used. Replaced by L10

TITLE: VLNA2+
Document Number: 0011/2011
Date: 10/06/2011 18:54:50
REV: A
Sheet: 1/1

Diagram 1 General circuit schematic of the VLNA. Individual bands have some component value changes and additions.

There are a small number of component value differences, depending on the band of use. The changes are shown in table 4, below.

Component	VLNA70	VLNA23/21	VLNA13	VLNA9
C1	10pF	2.7pF	3.3pF	1pF
L1	12.75 turns	3.75/2.75 turns	16mm loop	12mm loop
L2	10.5 turns	2.5 turns	1.5 turns	1.5turns
L3 & L4	8mm	8mm	8mm	8mm
L6	10nH	3.3nH	3.3nH	3.3nH
L9	10nH	3.3nH	3.3nH	3.3nH
L10	10nH	5.6nH	5.6nH	5.6nH
C7	10pF	2.7pF	2.7pF	1.0pF
C13	100pF	8.2pF	4.7pF	4.7pF
C14	100pF	N/A	N/A	N/A
R15	10Ω	N/A	N/A	N/A
FB	2 x Fe beads	N/A	N/A	N/A
T1,	Silicone	Silicone	Silicone	Polyurethane
T2,3,4	Silicone	Silicone	Silicone	Silicone

Table 4 component variations between the four band versions of the VLNA
R15 is connected in parallel with L9. VLNA70 now uses two ferrite beads on TR1 drain and has 100pF across C11

Unless otherwise stated, all other components are identical between band versions

The self-supporting input components are a feature adopted from the low noise pre-amplifier design by WD5AGO [2] and others. The input noise match uses a C/L/L circuit where the input capacitor both matches and provides a DC block for the bias on the gate of TR1. A series low-loss inductor (L1) provides another part of the match such that TR1 ‘sees’ the optimum noise match when ‘looking’ out towards the 50 ohm source. The third part of the noise match is provided by a shunt inductor (L2) from the input capacitor (C1) to the bias decoupling point. All three noise match components are air supported rather than mounting onto pads on the PCB. This reduces losses in the matching circuit and allows easy matching adjustment by ‘bending’ the series input inductor, L1. The use of a silver plated wire for L1 and L2 does not reduced losses enough to warrant its use in this stage.

Input return loss is improved by the use of loss-less series negative feedback. In this case by using long HEMT source leads. This technique has been used for many years, but its use has been tempered by the possibility of introducing instability at higher frequencies. Counter intuitively RW3BP has used longer than normal source leads in his improvement to the design. These are in the form of thin copper wires (L3 and L4) between the TR1 source leads and the source grounding pads on the PCB. He has also eliminated the lossy (and hence noise inducing) drain resistor (R3 in the original design) with an inductor, L10. He also used a further short length of copper wire to connect TR1 drain to the top of matching inductor L5. When copying Sergie's modifications I noticed a tendency for the amplifier first stage to oscillate at about 6-7GHz. This is different to the oscillation at 16GHz that had previously been observed. Curing the oscillation is simple and consists of placing two small pieces of silicone based absorber material close to C7 and L5, as shown in Fig 16, below. This is the same material as used for the end-wall absorber (to eliminate any 16GHz oscillation) and inside the 70, 23 and 13cm version lids (to make the metal lid 'invisible' to the high gain pre-amplifier stages and hence remove a possible feedback path via reflection).

Source feedback is also used in the second stage, but in this case it is printed onto the PCB (Shown as L7 but is actually two printed inductors) and cannot be adjusted. It was designed for optimum 23cm performance when the PCB was laid out.

A 5 volt 500mA surface mount voltage regulator (IC1) is used to provide power for both pre-amplifier stages. In the case of the first stage the + 5V is connected to R4 (220R) before continuing on to the drain of the MGF4919G via the various decoupling and matching components. When the bias for TR1 is correctly adjusted the drain current will be 16mA and this will cause the voltage across R4 to be 3.5V, giving a TR1 drain voltage of 1.5V. Slight variations on this voltage are to be expected when finally adjusting for optimum performance. The MGF4919G is a depletion mode device, requiring a small negative voltage (Gate to Source) to control the drain current. The negative voltage is generated by a surface mount ICL7660 DC-DC inverter chip (IC2). It produces -5V output for +5V input. This voltage is 'potted down' by the resistor chain consisting of R12, R13 and R14. R14 allows a small range of adjustment of the bias voltage such that TR1 cannot draw too much current. If the -ve bias voltage should fail TR1 would draw maximum current, limited to 22mA by R4. If the bias voltage is set too high, such that TR1 drain current is pinched off, the drain voltage could rise to 5V. Whilst I have never seen any degradation due to this effect the maximum drain voltage can be limited to 3V, as a precaution, by connecting a 3.0V zener diode across C5, with the cathode (bar end) to the junction of C5 and R4. It should not be necessary to connect a 10uF noise decoupling capacitor across the zener diode as the diode would only be effective under fault conditions and the pre-amplifier would not normally be expected to provide low noise operation under these conditions.







Active transistor bias is used to hold the operation of the ATF54143 enhancement mode FET (TR2) stable over a wide range of temperature. A BC807 PNP transistor (TR3) is the active bias device. TR2 operates at 64mA and can get rather warm. R9 sets the drain current for TR2. Without the active bias the noise and gain performance of the FET can

change noticeably between switch on and operation after several hours in front of a dish antenna. The second stage operates with approximately +0.54v on the gate and +2.95V on the drain at 64mA drain current.

SMA female connectors are recommended for use with the VLNA. SMA male connectors can be used if required. N connectors are not recommended for two reasons.

- 1) Difficulty of ensuring a good electrical contact around the input, where losses must be minimized and impedance maintained right up to the input noise match components.
- 2) Most EME systems now use a septum polarizer on 23, 13cm and 9cm. The inherent isolation between the transmit and receive ports of the feed is high enough that only a small SMA connectorised relay is required to protect the pre-amplifier when transmitting. Relays with N connectors are physically much larger than small SMA types and hence the pre-amplifier is likely to be further from the input connector with attendant increased loss and hence increased system noise figure. Terrestrial systems are not so noise-critical so it doesn't matter so much what relay and connectors are used as long as the isolation is high.

VLNA Details

Component	Photo	Details
L1		See table 4. VLNA70 shown . Closewound, 30AWG (0.314mm), Enamel covered copper wire. Inside diameter 2.5mm. 1mm 'tails' 9cm requires 9mm long 'hairpin'
L2		2.75/1.75 or 10.5 turns depending on band. See Table 4 . 2mm 'tails' VLNA70 shown
L3 and L4		8mm, wire as L1, bent into hook shape. To be soldered into vias next to TR1. Two required. Before and after shown.
L5		7mm, wire as L1. Bent to 'L' shape. Fair-Rite bead slipped over L5 as shown. 2 x FB required only for the VLNA70
T1		40 x 30mm 'tile' of ARC 10017 Absorber material
T2		8mm x 30mm 'tile' of ARC10017 material

T3 and 4		2 x 2mm x 15mm 'tiles' of ARC10017 material
T1 is positioned inside the lid and over the RF section.		
It should be approximately 2mm from the end and equally spaced from either side		
T2,3 and 4 should be positioned as shown in the component overlay		

Fig 1, component list for the VLNA. Read in conjunction with table 4, above.

Construction

I highly recommended that you build the pre-amplifier into the recommended size of box and place the input connectors where shown.

Not only is the box size important for stability, but so is the recommended absorber material, which **MUST** be used.

The current PCB current designation is G4DDK VLNA-Iss B

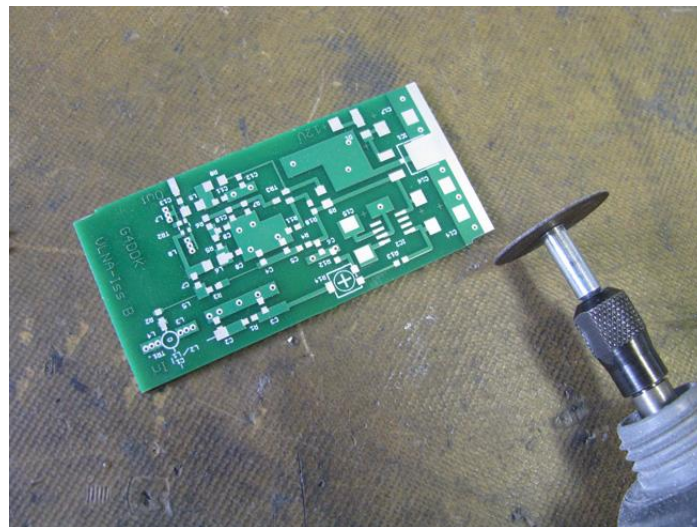

Fig 2 cutting the PCB corner notches

Preparing the PCB

The Dremel abrasive/slitting wheel is used to grind two small notches in the corners of the PCB as shown. These are required to allow the tin plate box to fit together properly. Ensure the notches are formed in the correct corners, as shown. The notches should be 1mm deep and 5mm long.

After grinding the PCB notches assemble the box (without soldering it together) and ensure that the PCB fits properly. As long as the notches are the correct size, it will fit perfectly into the box.

Clean the PCB with Isopropyl Alcohol (IPA) or Universal solvent (Rapid Electronics 34-0778) [6].

Optionally you can spray the component side of the PCB with spray solder flux to aid soldering. The small container (Rapid Electronics 87-0720) is highly recommended. It is cheap and long lasting.

Populate the PCB before soldering it into the tinplate box. Believe me, this is the BEST way!

Place the PCB on a white paper kitchen towel, under a good light. With a small, fine-tipped soldering iron and miniature 0.3mm diameter fluxed solder, suitable for SMD assembly, populate the board with all parts except TR1, L1, L2 and C1. You will need approximately 25cm of the fine solder to complete the PCB.

DO NOT attempt to use normal 0.7mm diameter solder. It WILL make a mess of the PCB!

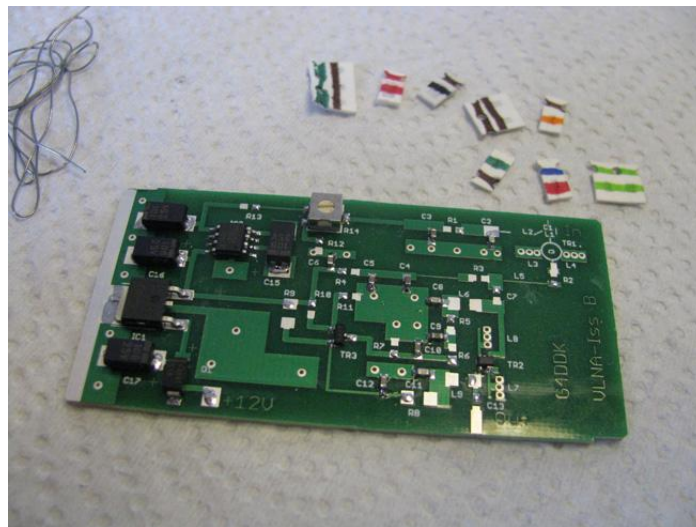

Fig 3 Populating the PCB

Start with the tantalum capacitors, C14, 15, 16, and 17. Observe the correct polarity for all four and especially the orientation for C14.

Follow with IC1 regulator, first soldering the two legs and then solder the tab down flat and firmly to the PCB ground plane.

The resistors, capacitors and inductors are next, followed by TR3, IC2, and TR2. Note that R3 is now replaced with 3n3H SMD inductor L10 (10nH for VLNA70)

I find it best to apply a small 'spot' of solder to one SMD pad. Place and hold the component, using a small pair of tweezers, (preferably stainless steel). Quickly solder the end with the solder spot, ensuring the component is absolutely flat to the PCB pads at both ends. Solder the other end and then go back and re-solder the first end.

Figure 3 shows the component overlay for the VLNA23.

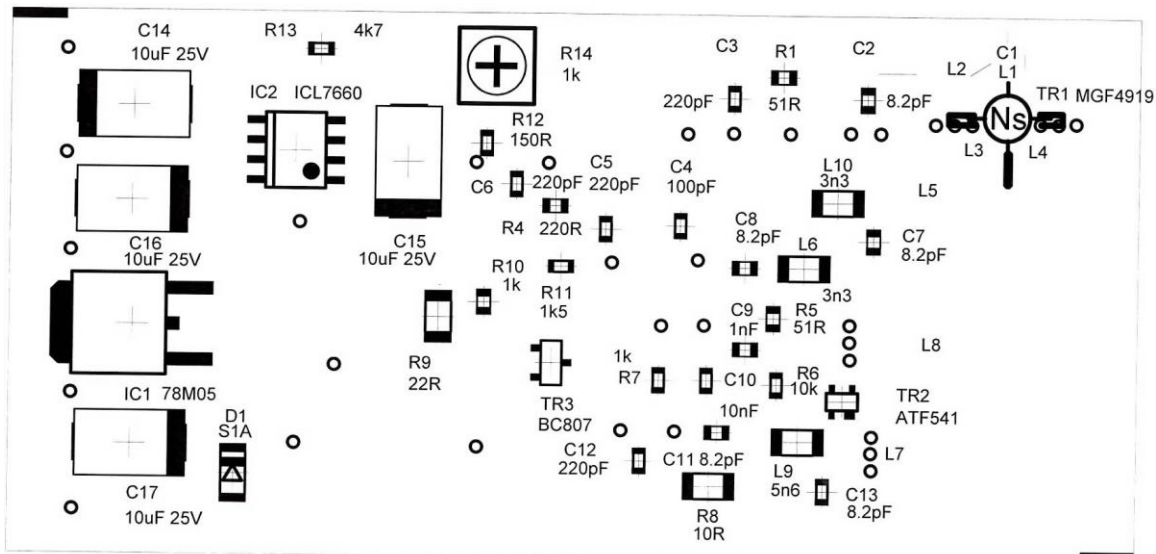

Fig 4 Component overlay (Component values shown for VLNA23)

When all the parts have been soldered to the PCB cut two 8mm lengths and one 7mm length of 0.315mm diameter enamelled copper wire as shown in figure 5



Fig 5 source and drain wires

Tin the ends of the three wires with a hot soldering iron tip (400C).

Insert the two 8mm wires in the two source pad vias nearest TR1 as shown in figure 6. The 7mm wire should be carefully soldered to the pad at the end of L5 and bent as shown in figure 6. The two longer wires should be inserted into the vias such that the ends on the ground plane side of the PCB do not extend beyond the holes. i.e. they should be just level with the ground plane. Carefully bend the protruding ends of the wire into hook shapes, also as shown.

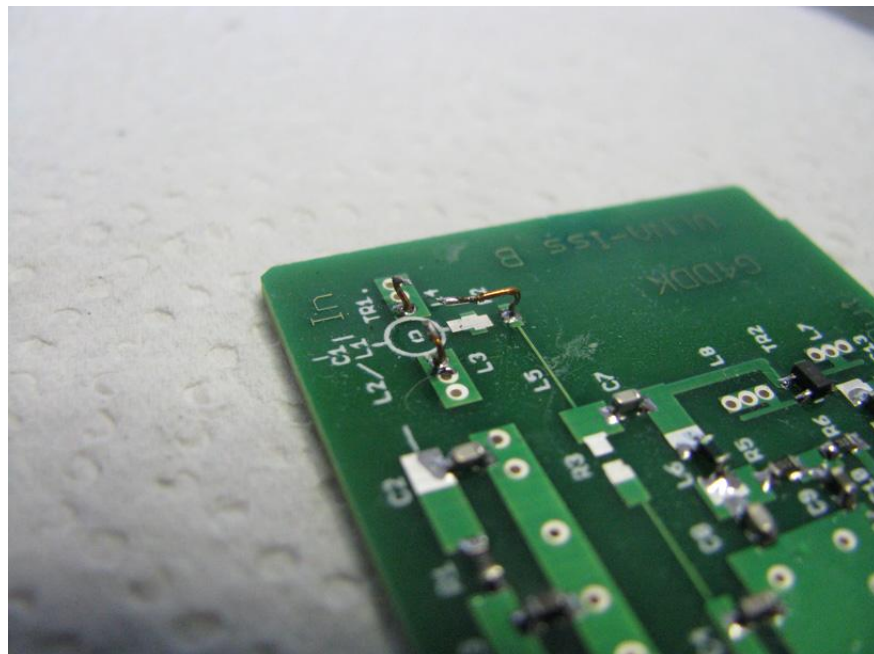

Fig 6 source wires in place plus drain wire

Fitting the GaAs FET.

Now VERY CAREFULLY solder one of the wider TR1 source leads to one of the source wires with the wire ABOVE the source lead. Solder the second source wire to the other source lead and finally solder the drain lead to the end of the wire going to L5 pad. If you use an MGF4941AL GaAs FET, then the wires will need to be soldered UNDER the device, due to their very short length. **BEND** the 0.315mm diameter leads back towards L5, by 45 degrees to reduce coupling to L2.

Figure 7 shows the arrangement. The FET will be approximately 2mm above the PCB with the leads bent as specified.

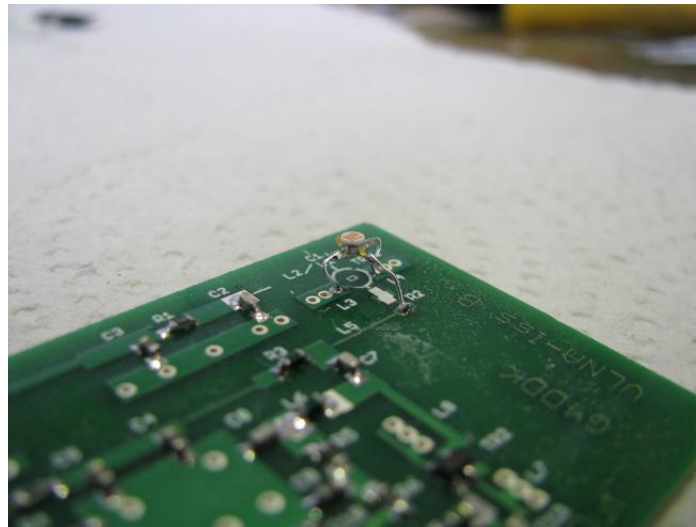

Fig 7 fitting the GaAs FET

It is recommended that a temporary thin wire is soldered between the pad at the top C2 and the gate of TR1 to protect the FET from accidental static damage when fitting the PCB into the box.

Inspecting the populated PCB

Inspect the populated PCB and ensure you have soldered every component to its pad and that the Tantalum capacitors are the correct way round.

Put the PCB on one side.

Please note that the edges of the tin plate box can inflict serious cuts to the fingers if handled carelessly. Handle with care. The author accepts no responsibility for any cuts you inflict whilst handling the box.

Preparing the box

Select the two sides of the box. With a Vernier caliper set to 10mm, scribe a line inside the box on both the long sides and the short sides. The two sides are scribed as shown in figure 8, where the lines have been emphasised with a marker pen.

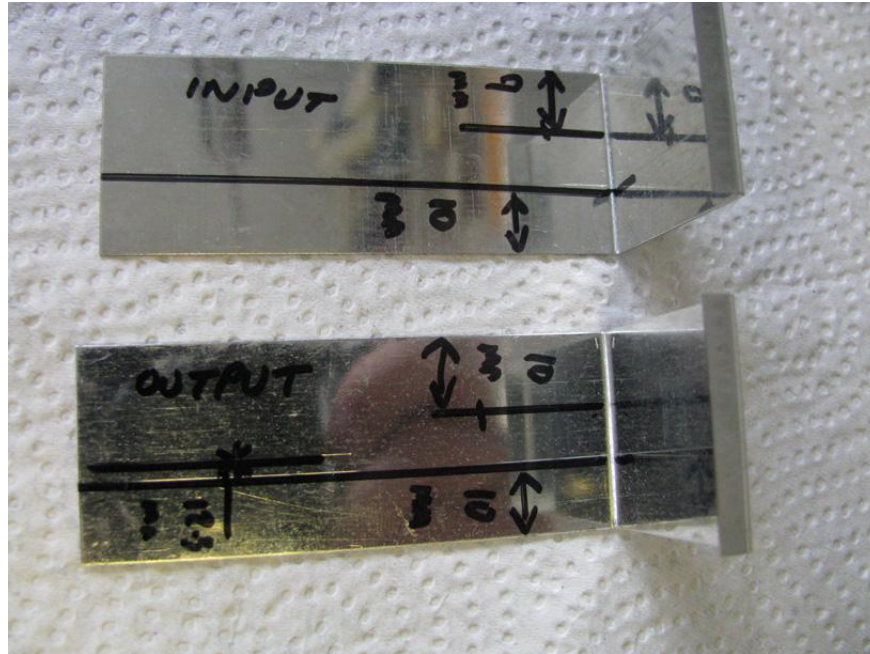

Fig 8 Marking the box

On the side selected to be the input side, scribe a second line 9mm down from the other edge and extending about 10mm from the fold between the long and short sides.

On the other side, selected as the output, scribe another line 10mm down from the other edge and extending about 20mm from the fold..

Re-set the caliper to 12.3mm and FROM THE SAME EDGE AS THE FIRST 10mm LINE mark up 12.3mm and extending about 25mm from the end of the side.

Hold the PCB up to the output side and mark along the shorter 10mm line a point in line with the +12v input pad.

Mark a similar point in line with the output track on the 12.3mm line. Centre punch both marks ready for drilling.

On the side selected as the input, mark a point 1mm **INBOARD** from a line through the gate of TR1. This is to allow enough room so that the flange of the input connector does not overhang the edge of the box. This should be marked with a centre punch.

Drill 4mm diameter holes for the input and output connectors, using a sharp drill bit. Drill from the inside of the box. Clean the hole on both sides with a small file or better still, a sharp countersunk bit.

Drill a 2mm diameter hole for the feedthrough capacitor, C18. Again countersink the hole to ensure a clean hole.

Preparing the SMA connectors

Where long insulation SMA connectors are used, prepare both connectors as shown in figure 9. With connectors that already have the insulation level with the rear of the connector, there is no need to cut the Teflon™



Fig 9 Preparing the connectors

Long insulation connectors

These are the recommended 2 hole female SMA connectors, made from brass and gold plated. The diameter of the TEFLON™ should be 4mm. Use a sharp blade to cut the insulation 0.5mm (thickness of the tin plate box) from the back of the connector. Slide the insulation off the connector spill. Cut the spill to an overall length of 1.0mm using a miniature Dremel slitting tool. Carefully face off the spill with the same tool.

Fit the PCB into the box

Offer the PCB up to the output side of the box as shown in figure 10, carefully aligning the ground-plane side to the scribed line. Push the PCB well into the short edge. Tack-solder the PCB on both the long and short edges. It will require lots of heat to do this.

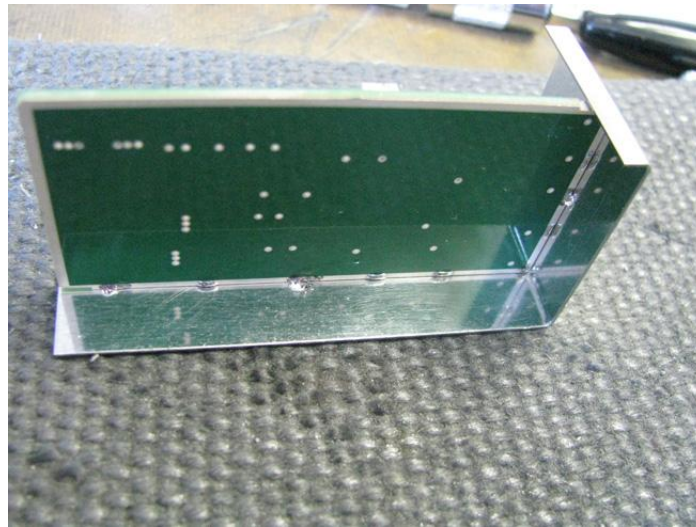

Fig 10 soldering the PCB into the box

Once you are sure it is square to the box, seam-solder the PCB to the box. This will require a 50w soldering iron and 0.7mm diameter fluxed solder.

Now place the side of the box, with the PCB, into the bottom of the box. Fit the second edge and ensure a good fit. Tack-solder the overlap at each of the two corners as shown in figure 11. For best appearance and good RF integrity, only solder on the inside of the box.

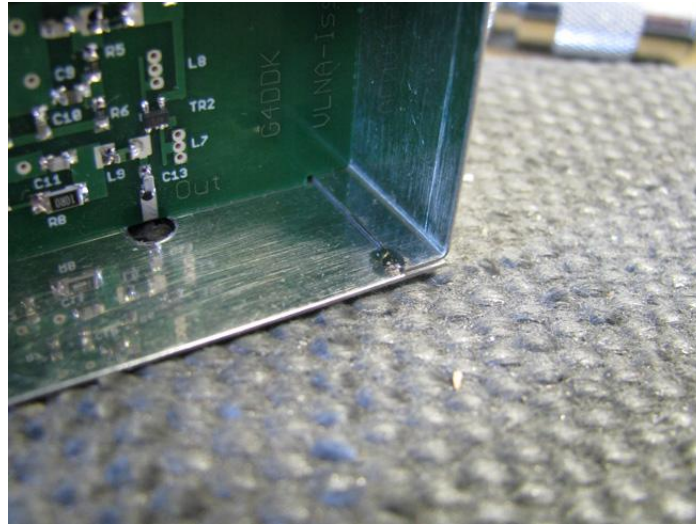

Fig 11 Tack soldering the corners

Now fit the lid to check for a good fit. If it is satisfactory remove the bottom cover and tack-solder the remaining two corners to form a rigid box section.

Carefully align the unsoldered edges of the PCB on the ground-plane side with the 10mm scribed line on the input side of the box and solder. When you are happy it is all square, seam solder all round the ground plane to attach it to the box. Also seam solder the component side copper along the short edge next to the regulator IC1. The seam soldering is shown in figure 12.

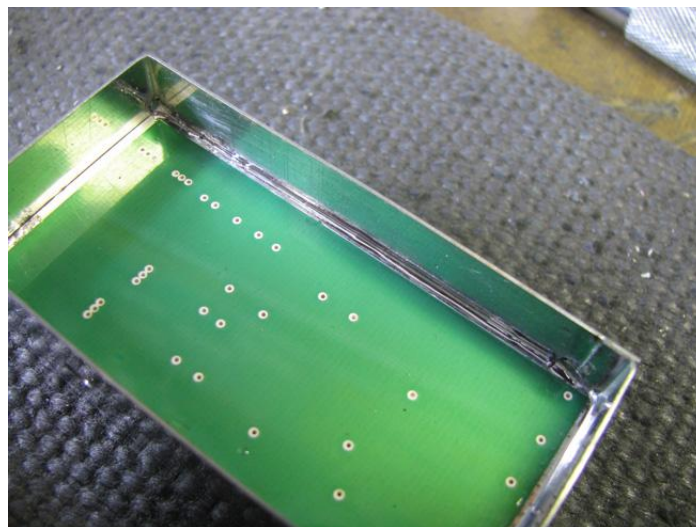

Fig 12 seam soldering the PCB into the box

Once the PCB is soldered into the box, the connectors can be fitted by seam soldering their flanges to the tin plate box as described next.

The connectors and feed-through capacitor

Solder the input connector first. Make sure it is centrally located in the 4mm diameter hole if using flush insulated connectors. When soldering, apply pressure to the end of the SMA so that it is pressed down firmly onto the tin plate box. Use a wood or aluminium handle so as not to damage the connector. There should be no gap showing between the flange and the box. Apply the solder into the mounting holes until it is seen to seep out under the flange of the connector. The soldered connector is shown in figure 13. This is critical for lowest noise performance.

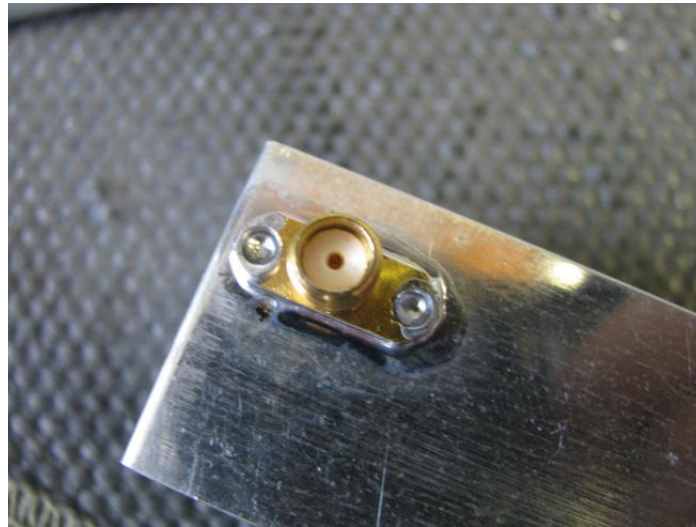

Fig 13 soldering the input SMA connector

Turn the box over, supporting the input connector against damage. Solder the output connector in the same way as for the input connector. When you are happy with the two connectors, solder the 1500pF feed-through capacitor into the 2mm diameter hole. Make sure you thread it through the 2mm ground solder tag first, as shown in figure 14.

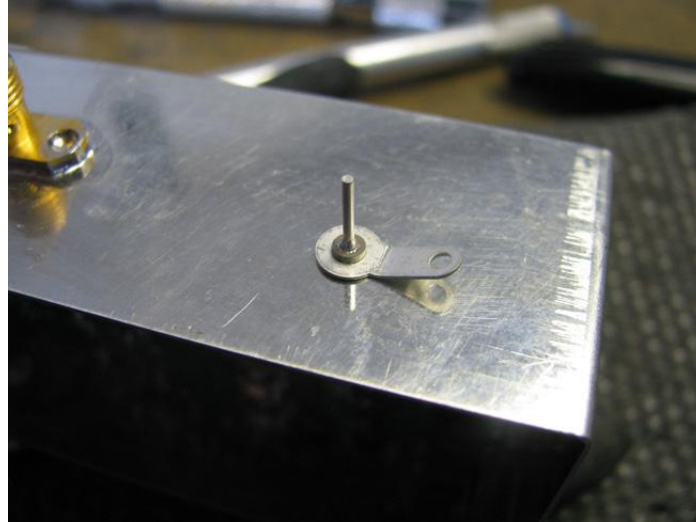

Fig 14 fitting the power feed-through capacitor

Use a short length of insulated wire to connect the +12v supply pad to the end of the feed-through capacitor, inside the box.

After assembly and fitting the connectors and feedthrough capacitor, clean off any flux residue with IPA or Universal solvent.

The input matching components for the 70cm version

L1 and L2 are shown in Figure 1. Note that the 70cm coils have more turns than the higher frequency VLNA versions.

Other changes to the VLNA70

A recent change is that two ferrite beads are now used on the drain of TR1 and a 100pF (C14) capacitor is soldered in parallel with C11 (8.2pF). These changes reduce the gain slightly and improve stability. Gain is now typically 36/37dB.

The input matching components for the 23cm version

Wind the two input coils, L1 and L2 as shown in figure 15. L1 should be $3\frac{3}{4}$ turns of enamelled copper wire of 0.315mm diameter. This coil is close-wound on a 2.5mm diameter former (use a 2.5mm diameter drill shank). The top turn is then opened out as shown in figure 15. For guidance, $3\frac{3}{4}$ turns will look like it is actually 4 full turns until the wire unwinds slightly!

L2 is wound with $2\frac{1}{2}$ turns of the same 0.315mm wire, close-wound on a 2.5mm diameter former (which is then removed). Note that the connecting tails should be at 180 degrees to each other, as shown in fig 15.

The ends of both coils must be tinned.



Fig 15 the 23cm inductors L1 and L2

The input matching components for the 13cm version

Wind L2 with 1 1/2 turns but otherwise as the 23cm version. L1 is now 16mm long and should be wound to be 3/4 turn loop on the 2.5mm diameter former. Open it out like a helter skelter as shown in fig 17b). The picture shows an MGF4941 used instead of the MGF4919

The input matching components for the 9cm version

Wind L2 with 1.5 turns but otherwise as the 23cm version. L1 is 12mm long and should be wound as L1 in the VLNA13, but it will be shorter, of course. This is as shown in fig 17c)

Fitting C1

Carefully tin the tip/end of the input SMA connector spill. Holding the input capacitor C1 with fine tweezers, solder it in place as an extension of the input spill. It should **not** be at an angle as shown in figure 16!

Note that C1 is a different value in each of the four versions of the preamplifier.

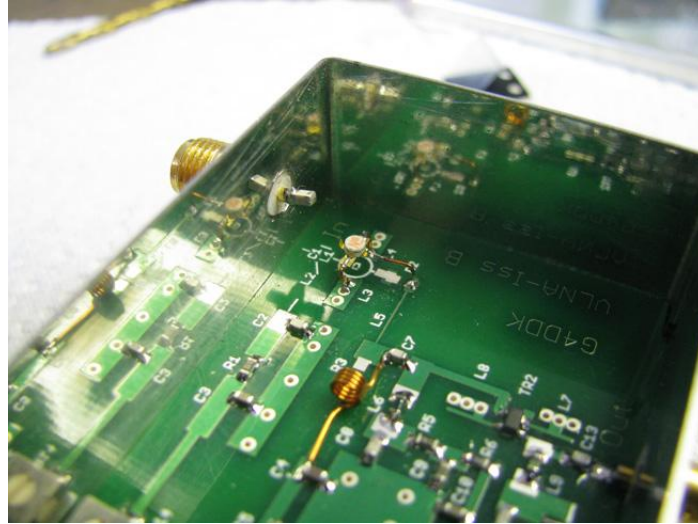

Fig 16 Soldering C1 onto the input connector spill

Also note that the hand wound choke shown in place of L10 in figure 16 is now replaced by an SMD inductor for repeatability.

Remove the shorting wire between TR1 gate and C2 (if fitted).

Solder L2 between the top of C2 and the end of C1. C1 is now supported so it will not now move. If necessary, go back and re-solder C1 accurately in line with the input connector spill.

70cm L1

Solder the opened-out end of L1 to the junction of L2 and C1. Solder the other end to the gate of TR1. It should go without saying that the soldering should be completed quickly and cleanly. The input to a low noise pre-amplifier is no place for sloppy workmanship. Make sure your soldering iron is properly earthed against static damage.

The top turn of L1 should be opened out and folded towards C1. This will be similar to fig 17(a) except that there will be more turns on L1 and L2.

23cm L1

Solder the opened-out end of L1 to the junction of L2 and C1. Solder the other end to the gate of TR1. It should go without saying that the soldering should be completed quickly and cleanly. The input to a low noise pre-amplifier is no place for sloppy workmanship. The completed 23cm input is shown in figure 17(a). Make sure your soldering iron is properly earthed against static damage.



Fig 17(a) 23cm input inductors and placing of the absorber

The coils should be orientated as shown. **Note how far the top turn of L1 is bent.** It is almost vertical.

13cm L1

Solder L2 as for the 23cm version. Note L2 is slightly shorter due to being just 1.5 turns, so that the connecting leads will need to be fractionally longer than for the 23cm version. Now solder L1 Loop between the junction of C1 and L2 and the gate of TR1.

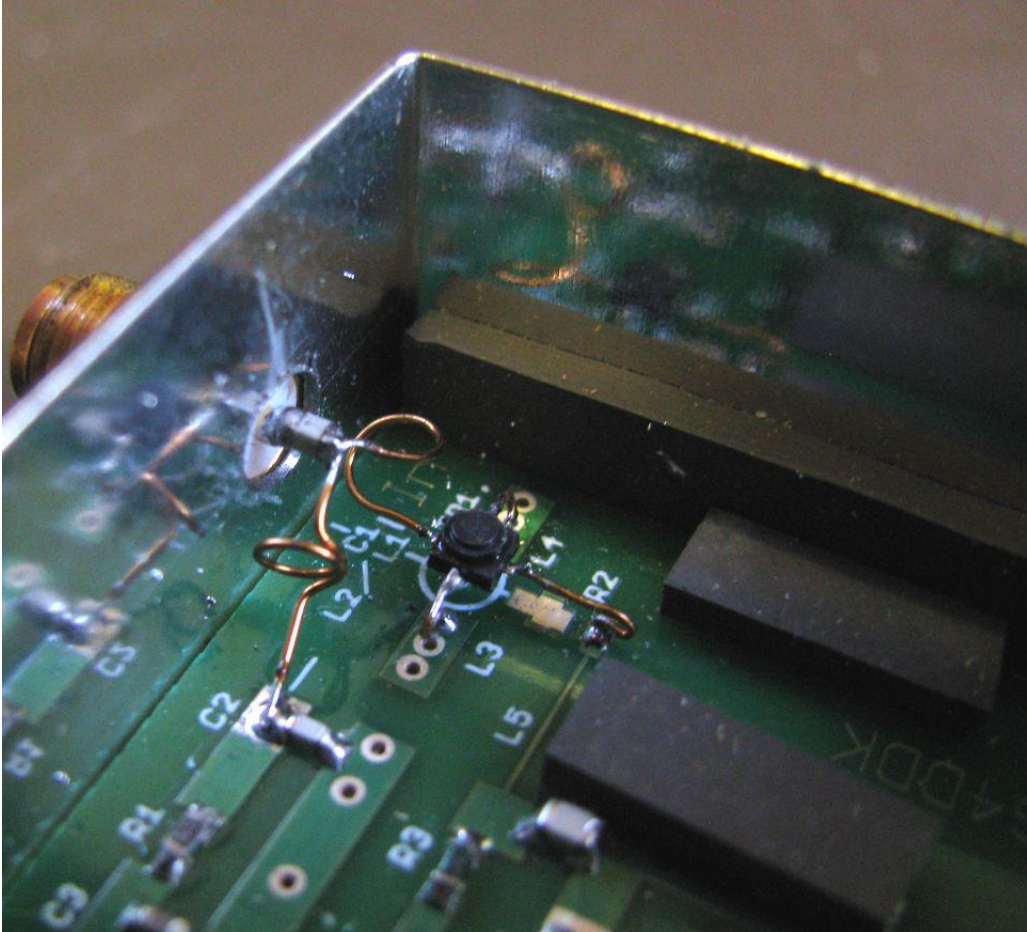

Fig 17(b) Orientation of the 13cm input inductor L1. TR1 is an MGF4941 in this photo.

9cm L1

Solder L2 as for the 23cm version. Note L2 is slightly shorter due to being just 1.5 turns, so that the connecting leads will need to be fractionally longer than for the 23cm version. Now solder L1 hairpin between the junction of C1 and L2 and the gate of TR1. This will look like the 13cm version, but L1 is shorter.

Absorber positions

The three pieces of absorber material (T2, T3 and T4) should be placed as shown in fig 17(a) for 70 and 23cm. i.e. the inboard piece should cover L5. The piece nearest the end wall should be parallel to the first piece.

The long strip (T2) should be stuck to the end wall of the box, close to L1 and pressed down onto the PCB.

The larger tile (T1) should be stuck inside the lid of the box and towards one end so that when the lid is in place the absorber is over the RF stages.

For 13 and 9cm T4 should not quite cover L5.

This completes the VLNA build.

Testing and adjusting the VLNA

Voltage checks

Connect +12 to +20V to the feedthrough capacitor C18 and the negative (ground) to the solder tag.

Connect good quality 50Ω SMA terminations to the input and output connectors.
Adjust R14 fully anti-clockwise and then turn clockwise about 30 degrees (not critical).

Switch on the supply and check that the total current taken is approximately 80mA +/- 10mA.

With a digital voltmeter, check that the output from IC1 is +5.0V, +/-0.1V

Check that the output from IC2 is -5.0V, +/- 0.2V. Test at IC2, pin 5.

Check the DC conditions around the circuit.

A suitable probe for checking voltages in RF 'hot' areas is shown in figure 18

Attach a 10K resistor to the end of a meter red (+) lead. Wind the lead of the resistor around the probe lead. Cut the other resistor lead to about 3mm long.



Meter Probe and lead

Fig 18

Measure the voltage on the drain of TR1. It should be 1.5V +/- 0.1V. Use R14 to adjust it to 1.5V initially. It will probably need to be changed later as you tune for best noise performance. At this stage, if you don't have terminations on the input and output of the pre-amplifier, it might self-oscillate. If that occurs the two drain voltages may read incorrect values due to rectified RF.

Measure the voltage on the drain of TR2. It should be 2.95V +/- 0.1V. You cannot adjust this voltage. It will either be right or wrong. If it's wrong you have a fault to find!

If these are correct, you can proceed to adjust the pre-amplifier.

Adjusting the pre-amplifier for lowest noise performance at 23cm.

This procedure is described for the 23cm VLNA. It is similar for the other bands with some changes, as detailed later.

If you have an HP8970A/B or Eaton/Ailtech 75 series meter with a 5dB ENR noise head then it is a simple matter of connecting the noise source to the pre-amplifier input and the output to the NF meter input, and adjusting L1 for lowest noise figure, consistent with a gain of about 36 – 38dB. If you have a 15dB ENR head then you **MUST** use it with an attenuator or the results may be considerably in error.

The attenuator's value **MUST** be known to 0.01dB at 1296MHz for accurate results. That is a tall order.

Depending on the NF meter, you may need to use an intermediate frequency converter to convert 1296MHz down to, say, 144 or 30MHz.

If you are able to measure noise figure and gain between 1000MHz and 1500MHz it is worth checking that you have adjusted L1 for lowest noise figure at 1296MHz (or wherever you need lowest). The gain maximum will be found to be around 1100MHz +/- 50MHz when the noise is at a minimum at 1296MHz. Peak gain is over 40dB. This is the normal characteristic of the pre-amplifier. The noise minimum is located HF of the gain peak.

Once you have adjusted L1 for lowest noise figure, re-adjust R14 to give highest gain (probably only 0.5dB or so increase) consistent with lowest noise figure.

Figures 19a) and b) show close ups of L1 and l2 in the VLNA23

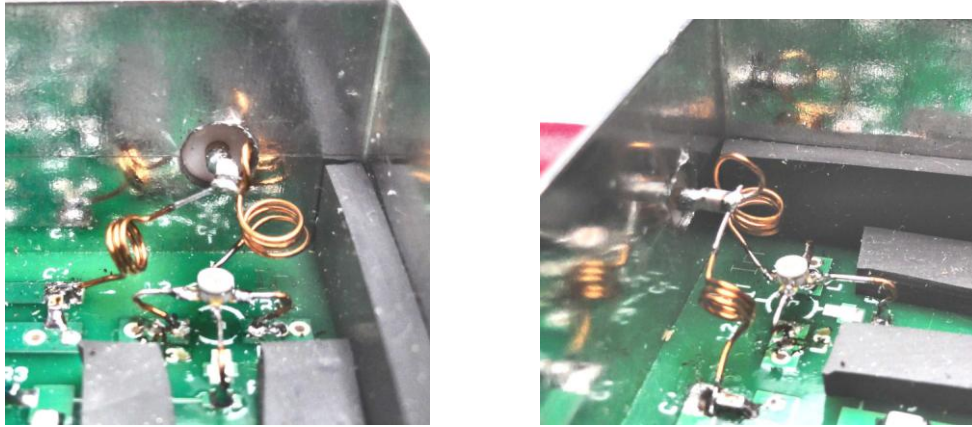

Fig 19 (a) and (b) correct orientation of L1 and L2 for the VLNA23. L3 and L4 should be folded back 45 degrees as described above.

Adjusting for lowest noise figure without a NF meter

If you do not have, or are not able to gain access to, a suitable NF meter but have a spectrum analyser that covers up to 2GHz then you can use the noise peak shown in figure 20 as a means of checking that the preamplifier is working correctly. Figure 20 is a screen shot of the output of the pre-amplifier from 250MHz to 2GHz. The broad noise is clearly seen, peaking at about 1075MHz at a level of about -55dBm in 3MHz bandwidth.

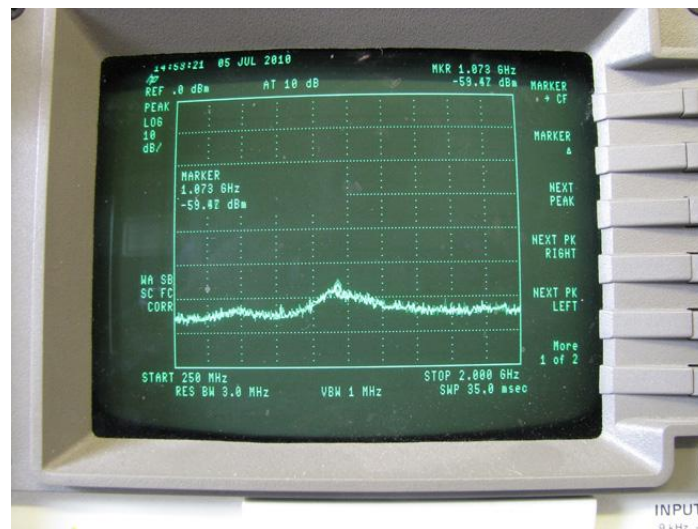

Fig 20 noise peak

The pre-amplifier input is terminated in a 50Ω SMA and the output is connected to the spectrum analyser through a suitable low loss coaxial cable.

If you do not have either a noise figure meter or a suitable spectrum analyser, then the pre-amplifier will have to be adjusted using a weak off-air signal, such as a beacon. This

is best done using FM demodulation where the beacon signal is just strong enough to cause some quieting of the receiver noise output. In this condition the audio signal to noise ratio is strongly dependant on the carrier to noise (which you are trying to minimize) ratio over a range of just a few dB.

Once the pre-amplifier has been tuned for lowest noise figure the lid can be fitted. The absorber material (T1) will ensure that the pre-amplifier remains stable. The lid essentially becomes 'invisible' to the pre-amplifier stages below.

Adjusting the 70, 13 and 9cm preamplifiers for lowest noise

The same technique is used as for 23cm. You may be surprised to see that the noise peak frequency does not change dramatically from the 23cm version. The reason for this is that the original board was designed for 23cm and some of the components are printed onto the board. This tends to mean that the NOISE gain peak is rather lower than the frequency for which you adjust the minimum noise figure. However, the noise figure is determined in the matching and first active device. Subsequently the second stage gain is lower than in an optimised design for the higher frequency. Perhaps fortuitously the overall preamplifier noise figure and gain is excellent at 70cm, 13cm and 9cm in spite of the other limitations.

Adjusting the VLNA preamplifiers for best input return loss

If you have access to a network analyser covering the required frequency range, adjust L1 for best return loss. For 23cm this will be of the order of 6-10dB. For 13cm it should be 6-10dB whilst for 9cm it should be approximately 5dB. At 70cm the input return loss can be as high as 20dB with careful adjustment.

All input return loss measurements should be done with no more than -30dB input power, especially at 70 and 23cm, where the high gain of these preamps may lead to output compression and cause erroneous results.

The output of the preamp should be terminated in a GOOD 50Ω SMA termination during the input return loss measurement.

Operating the pre-amplifier

The pre-amplifier can be operated with a supply of between 10V and 24V. The input Tantalum capacitor, C17, should be rated at 25V or higher. In the kit the supplied tantalum is 25V working.

It is possible to power feed the pre-amplifier over the output coaxial cable by adding a 10 turn choke between the spill of the output capacitor, C13, and the end of the feedthrough capacitor C18, inside the box. Do be careful when doing this that this is the ONLY power supply in use. Also mark the outside of the box to show this modification. You might just forget..... Ten turns on a 2mm former, air wound, seems to work well for all four band versions of the VLNA.

I usually operate my masthead (terrestrial and EME) pre-amplifiers in parallel with the antenna changeover relay or protection (EME) relay. The relay can simply be power fed from the end of C18 outside the box. If a 28V relay is used, it will be necessary to change C17 from a 25V working Tantalum to a 35V version or you will end up letting smoke out of the pre-amplifier box! It is wise to connect a 1N4000 series diode across the relay coil to short any back EMF when the relay releases. I have operated my systems this way for many years without any pre-amplifier failures. When running the pre-amplifier from +28V in this way make sure the case is in contact with a large area of metal to act as a conduction cooling system for the regulator. A 19V ex-laptop DC supply can often be used as the supply for parallel preamp/relay systems.

Protecting the tin plate box against rusting can be a problem in humid climates. In general, the inside of the box does not rust. By applying a spray-on coat of conformal coating to the outside of the box, rusting can easily be prevented.

Pre-amplifier stability

With the modifications proposed by RW3BP the pre-amplifier should be completely stable even with the input open circuit. The stability is NOT guaranteed at all phase angles, however, so operating it open circuit is not recommended.

The pre-amplifier input return loss should be 6-10dB (or better), depending on how L1 is set. Whilst this is not as good as RW3BP has measured, it is much better than the earlier VLNA design. Better input return loss will NOT improve the pre-amplifier noise performance, but it does mean that the uncertainty in NF measurements is much reduced, leading to more confidence that the measured noise figure is correct when carefully measured in a calibrated system.

The modified pre-amplifier is much easier to tune for low noise figure than the original design and it is often unnecessary to do more than adjust L1, as discussed, to achieve better than 0.35dB at 70cm, 0.25dB NF at 23, 0.3dB at 13cm and 0.4dB at 70cm. Results on 9cm tend to be more variable, but better than 0.5dB is usually achieved.

That's it. You should now be ready to use your new very low noise VLNA pre-amplifier.

Kits

Kits are available from the author to build any of the VLNA versions. The kits are complete and include all hardware parts except the solder. Even this is available, if you would like enough of the thin type for SMD assembly. The catch is that the package will exceed 100grams so you may need to pay a little more for postage!

All parts are new except for the MGF4919 GaAs FETs which are surplus stock.

The supplied PCBs are 1.6mm FR4 with silver immersion plating. They are solder resist (green) covered and silk screened with all component designations. All holes are PTH.

The kit pricing is posted on my web page.

www.g4ddk.com

References

[1] RW3BP

http://www.vhfdx.ru/apparatura/rw3bp_1296mhz_lna_optimization

[2] WD5AGO

Low Noise 2-stage amplifier for 23cm

Proceedings of the Microwave Update 1999, Plano Texas.

[3] G4DDK

www.g4ddk.com

[4] Proceedings of the 13th International EME Conference Florence, August 2008

[5] 'low Noise Pre-amplifiers for 1.3, 2.3 and 3.4GHz Amateur Bands' CQ-VHF Summer 2008

[6] Rapid Electronics

www.rapidonline.com

Document history

Issue A released 07/07/2010
Issue B released 27/07/2010 – 13cm added
Issue B2 released 18/08/2010 – 13cm T3 info amended
Issue C released 11/6/2011 - VLNA2+. Updated to include 13 and 9cm. Appendix 2 removed as no longer necessary. Some small text changes and performance table now included.
Issue C2 released 14/6/2011 - Figure 16(b) replaced with photo.
Issue D1 Released 16/8/2012 - EME 2012 Presentation and DVD. Extensive re-write
Issue E1 Released 21/9/13 - Updates for VLNA70 and VLNA21