

# VHF LOW NOISE PREAMP KIT

---

**Ramsey Electronics Model No. PR100**

---

*Boost up those weak signals without adding in unwanted noises! The PR100 has a three section tuned circuit and a double helical filter to allow only the desired signal to be amplified, while attenuating signals outside the band. A perfect match for any 2 meter receiver!*

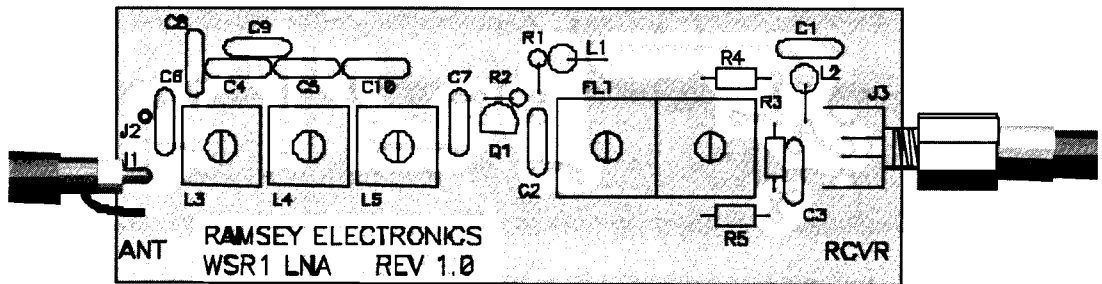

- Extensive filtering for low noise operation, 1dB noise figure!
- Three section tuned circuit and double helical filter
- Centered on 145 MHz and is 2.8 MHz wide
- 16dB Gain
- Perfect match for any VHF Receiver
- Powered through antenna feed line, or separately
- Runs on 12VDC
- Designed to fit inside of 1 1/2" PVC for quick and easy mounting



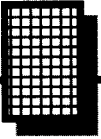

## KIT ASSEMBLY AND INSTRUCTION MANUAL FOR

# VHF LOW NOISE PREAMP KIT

### TABLE OF CONTENTS

Introduction to the PR100 .....	4
How it Works .....	4
Schematic.....	5
Parts Layout.....	6
Strategy.....	7
Assembly Steps .....	8
Alignment .....	11
Installation .....	12
Troubleshooting .....	13
Warranty.....	15



**RAMSEY ELECTRONICS, LLC**  
590 Fishers Station Drive  
Victor, New York 14564  
Phone (585) 924-4560  
Fax (585) 924-4555

## **INTRODUCTION TO THE PR100**

This amplifier is a truly necessary piece of equipment for your 2 meter receive applications. With 16dB of gain, you mount this up on your mast on the antenna to boost those weak signals to a receivable level. This results in clear, unbroken reception, and a more pleasant listening experience.

The filtering of the preamplifier is narrow enough only to allow the desired frequency band through, while rejecting all others. This prevents many problems associated with interference such as intermodulation and front end overload. Having such a narrow bandwidth also reduces background noise that would normally be present in wider band amplifiers.

Hookup is very simple in that the unit is powered through the same cable that you receive your signals through. It is possible to 'feed' the 12VDC up the coax cable to the preamplifier. No new wires to run and makes for less weatherproofing.

The PC board was designed to fit within a 1 1/2" PVC pipe, so a simple enclosure could be created out of one piece of pipe and two endcaps. Glued together it can make for the perfect weatherproof enclosure.

## **HOW IT WORKS**

There really isn't much to the preamplifier if you look to the schematic at the right. It mostly consists of filtering, and has only one active part, Q1. We will start from the Antenna end of the preamp, and then on to the receiver end.

J1 and J2 is where the user can connect two different antennas. Some people recommend that you use two turnstile antennas at right angles to each other for good satellite imaging, if you're using this with a weather satellite receiver. This allows for good coverage of the horizons. Normally you will only use one of these jacks.

From these jacks the unfiltered RF passes through C6, into the bandpass tank circuit consisting of inductor L3 and capacitor C8. This tank circuit and the next two are eventually tuned to be centered at 145 MHz. C4 allows some of the RF from the first tank circuit to be allowed into the next, but is very small in capacitance to offer a large reactance (resistance to AC). This high reactance allows the tank circuits to perform their jobs better by giving them a higher Q factor. This means that the spectrum of RF the tank circuits will allow through becomes narrower due to the high Q.

The RF passes through two more tank circuits consisting of L4 and C9 in the second, and C12 and L5 in the third. Every time the RF goes through an additional tank circuit, the bandpass bandwidth of the RF is narrower. The narrower the bandwidth is before the active component of Q1, the better.

The narrow bandpass allows Q1 to devote its amplification to just the desired signals. This means that it doesn't amplify nearly as much noise, and won't amplify signals outside of the bandpass area. Q1 amplifies the RF up to a respectable level, where it is sent out to FL1, the dual helical filter.

With steep cutoff frequencies and low loss, FL1 has very good bandpass characteristics for our preamp. This filter is essentially a series of tank circuits that have very high Q, and is designed with a specific frequency band in mind. It is tuned by the user to be centered at 145 MHz with the two coils inside.

L2, L1, and C1 allows the DC fed through the coax line to pass on to Q1 to power it, while rejecting the RF so that the unit does not self oscillate. C3 blocks the DC from coming into the filters, but allows the RF down to the cable.

## SCHEMATIC DIAGRAM

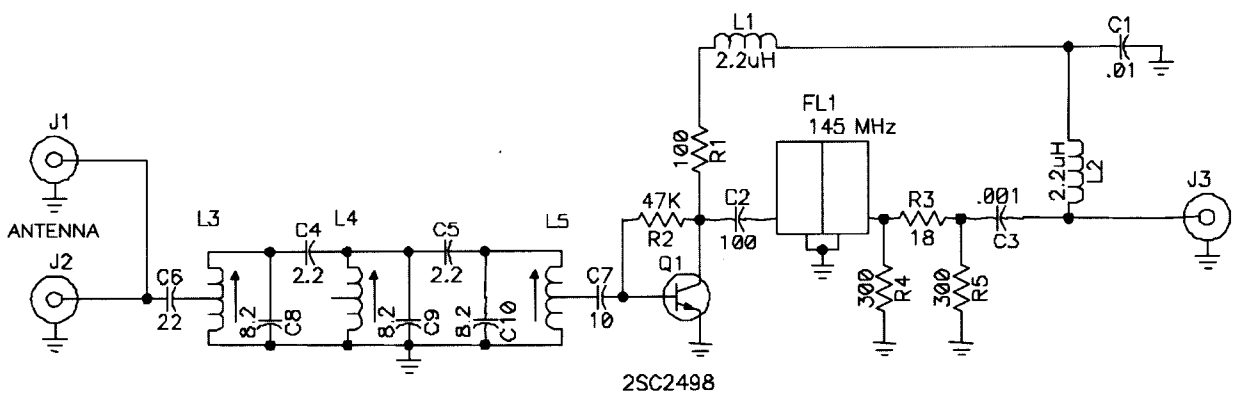

## PARTS LAYOUT DIAGRAM

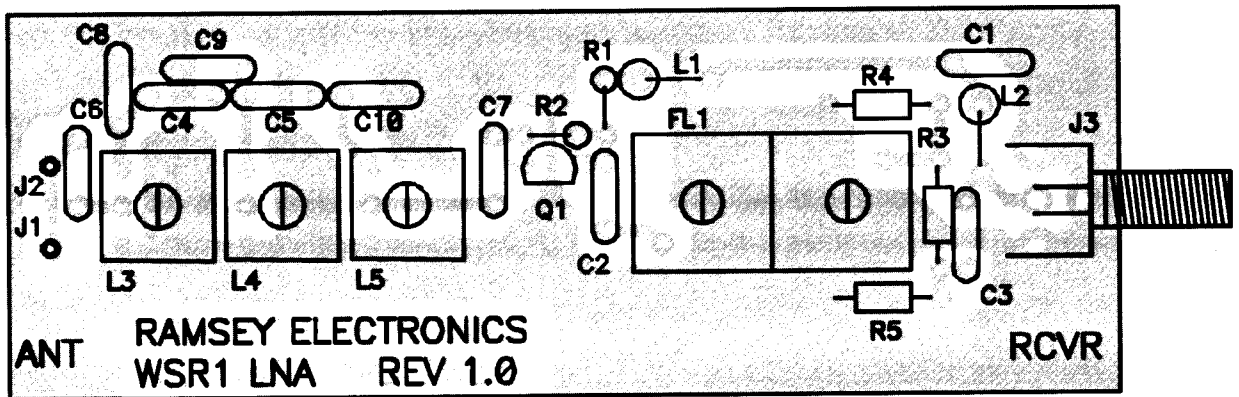

## PARTS LIST

### **CAPACITORS**

- 2. 2.2pF ceramic capacitors (marked 2.2) (C4, C5)
- 1 10pF ceramic capacitor (marked 10) (C7)
- 3 8.2pF ceramic capacitors (marked 8.2) (C8, C9, C10)
- 1 22pF ceramic capacitor (marked 22) (C6)
- 1 100pF ceramic capacitor (marked 100, or 101) (C2)
- 1 .001uF ceramic capacitor (marked .001, or 102) (C3)
- 1 .01uF ceramic capacitor (marked .01, 103, or 10n) (C1)

### **FIXED RESISTORS**

- 1 100 ohm resistor (brown-black-brown) (R1)
- 1 18 ohm resistor (brown-grey-black) (R3)
- 2 300 ohm resistors (orange-black-brown) (R4, R5)
- 1 47K ohm resistor (yellow-violet-orange) (R2)

### **SEMICONDUCTORS**

- 1 2SC2498 or 2570 NPN UHF transistor (Q1)

### **INDUCTORS AND FILTERS**

- 3 359-7787 Variable inductors (metallic cans with slug) (L3,L4,L5)
- 2 2.2uH inductors (green body with red-red-gold stripes) (L1, L2)
- 1 2 section helical filter, 145 MHz (Large metallic can with two adjustments) (FL1)

### **CONTROLS, HARDWARE & MISCELLANEOUS**

- 1 Type-F connector (J3)
- 1 PC Board

## RAMSEY "LEARN-AS-YOU-BUILD ASSEMBLY STRATEGY"

We'll start building on the left side and work our way across, installing the lower components up to the taller sized components. This will make our placing and soldering of components easy.

Be sure to read through all of the steps, and check the boxes as you go to be sure you didn't miss any important steps. Before you connect up the kit in a hurry to see results, check all diodes, ICs, and capacitors for proper orientation. Also check the board for any possible solder shorts or cold solder joints. All of these mistakes could have detrimental effects on your kit - not to mention your ego!

### **Kit building tips:**

Use a good soldering technique - let your soldering iron tip gently heat the traces to which you are soldering, heating both wires and pads simultaneously. Apply the solder on the iron and the pad when the pad is hot enough to melt the solder. The finished joint should look like a drop of water on paper, somewhat soaked in.

Mount all parts on the top side of the board. This is the side that has no traces or pads on it.

Part orientation - All parts in the kit are mounted at 90 degree angles to each other, meaning that all parts are either parallel or perpendicular to the board.

Part installation - when parts are installed, the part is placed flat to the board, and the leads are bent on the backside of the board to prevent the part from falling out before soldering. The part is then soldered securely to the board, and the remaining lead length is then clipped off. Since this is an RF project, make sure that lead lengths are as short as possible, coming only second to neatness.

In ALL PC board assembly steps, our word "INSTALL" means to do this:

- Insert the part, oriented or "pointed" correctly, into its holes in the PC board.
- If helpful, gently BEND the part's wire leads or tabs to hold it into place, with the body of the part snugly against the top side ("component side") of the circuit board.
- Solder ALL wires or pins of the part.
- Trim or "nip" all excess wire lengths extending beyond each solder connection, taking care that wire trimmings do not become lodged in solder connections.

## ASSEMBLY INSTRUCTIONS:

- 1. Orient the PC board as in the Parts Layout Diagram. We will start with the left hand side of the board, then go to the right.
- 2. Install C6, the 22pF ceramic capacitor (marked 22).
- 3. Install C8, a 8.2pF ceramic capacitor (marked 8.2).
- 4. Install C4, a 2.2pF ceramic capacitor (marked 2.2).
- 5. Install C9, a 8.2pF ceramic capacitor (marked 8.2).
- 6. Install C5, another 2.2pF ceramic capacitor (marked 2.2).
- 7. Install C10, yet another 8.2pF ceramic capacitor (marked 8.2).
- 8. Install L3, one of the metallic, square shaped inductors (marked 359-7787) Make sure the holes line up with the pins before soldering.
- 9. Install L4, another one of the inductors (marked 359-7787)
- 10. Install L5, the last of the tunable inductors (marked 359-7787).
- 11. Install C7, a 10pF ceramic capacitor (marked 10).
- 12. Install Q1, the 2SC2498 NPN UHF transistor. This transistor has excellent low noise characteristics, and can amplify signals into the microwave region! Note that the pin out of this transistor is different than that of a switching transistor, so mount it in the orientation as shown in the Parts Layout Diagram. Make sure and use the correct holes for mounting!
- 13. Install R2, a 47K ohm resistor (yellow-violet-orange). Note that it is a stand up part. Keep the leads as short as possible, as well as neat!
- 14. Install R1, a 100 ohm resistor (brown-black-brown). This is also a stand up resistor as well. Bend your leads as shown in the diagram.
- 15. Install C2, a 100pF ceramic capacitor (marked 100 or 101).
- 16. Install L1, one of the 2.2uH coils (green body, red-red-gold stripes).
- 17. Install R4, a 300 ohm resistor (orange-black-brown). Notice that this is a lay down part.

- 18. Install C1, a .01uF ceramic capacitor (marked 103, .01, or 10n).
- 19. Install L2, another 2.2uH inductor (green body, red-red-gold stripes).
- 20. Install R3, a 18 ohm resistor (brown-grey-black).
- 21. Install C3, a .001uF capacitor (marked 102, or .001).
- 22. Install R5, a 300 ohm resistor (orange-black-brown).
- 23. Install FL1, the two section helical filter. Make sure and mount it firmly to the board, and that all leads are soldered correctly.

At this point we will check all solder joints for possible cold joints or even worse, solder bridges. Make sure everything looks neat and clean before continuing, since the better it looks, the easier it is to find problems.

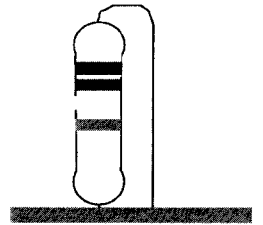

- 24. If you have the appropriate F-connectors, install J3, otherwise leave this part out so that you can solder your connecting cable straight to the PC board.

Congratulations! You have completed assembly of your PR100. Before continuing on to install your new preamp, check all of your solder joints thoroughly, as well as part orientation. You definitely don't want to seal this into a weatherproof container before you verify if it works or not!



## **ALIGNMENT:**

Alignment is fairly simple if you follow these guidelines. The first step is to back all of the lugs out of L3, L4, and L5 until they reach the top of the cans. FL1 should be ok, and won't need any adjusting.

- 1. Screw L3 in 8 turns.
- 2. Screw L4 in 8 turns.
- 3. Screw L5 in 8 turns.

If you have the equipment and the know-how, you can adjust the coils and the helical filter further. You will need a spectrum analyzer and a frequency generator to run at 145.52 MHz for best alignment.

Set the generator to 145.52 Mhz and tune the coils to get the greatest amplitude and the best shape. Check the width of the bandpass to make sure it is centered on 145.52 MHz, and is about 2.8 MHz wide. Sweep through to check the shape of the bandpass, it should be close to flat across the bandpass, if not you will need to tune the helical filter.

## **PREAMP INSTALLATION**

This part of the manual assumes that you have a receiver or transceiver (if using a transceiver a TR Switch is needed, like our RFS-1). This preamp operates off a 12 volt DC supply which is connected to a 2.2  $\mu$ H inductor then to the center of the antenna cable near your radio(see diagram on next page). Care has to be taken so that you don't short out any connections. Also a .01 $\mu$ F ceramic capacitor must be installed after the radios' output and before the connection to the 12 volt supply. This capacitor serves as a DC block while allowing RF to pass through.

Installation of the preamp is fairly simple, yet there are a few considerations you will wish to look into before you continue.

Any RF preamp should be located as close as possible to the antenna itself for best performance. This is due to the losses involved in the cabling to the antenna. Since a signal can be very weak at the antenna, it can be almost nonexistent after it has gone through a length of cable. A non existent signal doesn't get amplified very well. If you boost the weak signal near the antenna, it can be boosted to a high enough level that it can easily be sent down the length of the cable.

## THE PR100

Hookup is simple if you are using coax cable such as RG-58 or better 50 ohm cable. Just run a piece from the jack marked RCVR (J3) on the PR100 to the .01 $\mu$ F capacitor just before the radio. Then a short piece is needed to go from the capacitor to the radio. Finally, you need to connect the Preamp to the antenna and you are ready for testing.

### HOOKUP EXAMPLE

Turn on your receiver, you should be able to pick up a weak signal with little difficulty. If you are not receiving anything yet, check your 12 volt DC supply. If you are still having troubles, test for the twelve volts present on the preamp, then check the orientation of the preamp. If both are correct, you may need to check your preamp for proper assembly, or even possibly your cabling for opens. Consult the assembly instructions for some help on these matters.

Antenna

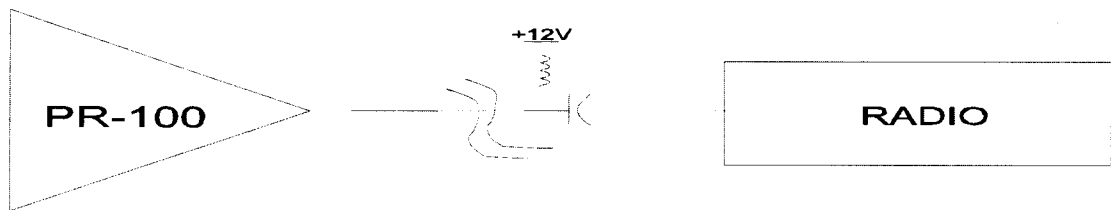

## TROUBLESHOOTING GUIDE:

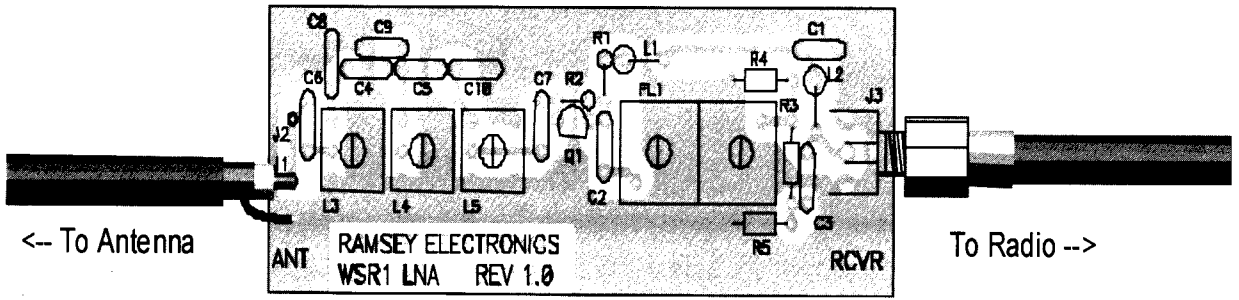

**Problem:** When I insert this in line, I don't observe any gain in reception.

**Solution:** There are several causes to the problem, but the major one is that the preamp has been assembled incorrectly. Check Q1 for correct installation, then check J3 for 12VDC. If those check out, go through assembly steps again to make sure you have the parts where they belong.

**Problem:** I can't get the @#\*%! thing to work, it's Ramsey's fault!

**Solution:** Read the warranty information on the last page.

