

# Monitor Sensors 630m Transverter Operator's Manual



## Installation

### Location

The transverter should be located near to the HF transceiver, but make sure there is sufficient ventilation around the transverter. The air in-take vent, beneath the front panel, and the outlet vent on the rear panel should be kept clear at all times.

### Power Supply

The transverter requires +13.8VDC at up to 15A. It will operate from 10 to 16V with reduced power output at 10V. The negative side of the supply is connected directly to chassis. There are two Anderson power pole connectors on the rear of the transverter. These are connected directly in parallel, so either can be used to power the transverter. The other is then available to power other equipment. The transverter itself is protected against reverse polarity and will not turn on. However, be aware that any other equipment connected to the second power socket will not be protected if the supply is reversed. Locate the power cable supplied with the transverter. One end is terminated in an Anderson power pole. The other end needs to be connected to your PSU. The red wire is positive and the black wire negative. Never connect the Anderson power pole with power on the cable. Make sure the Anderson power pole is properly seated before turning on the PSU.

### RF Connections

The rear of the transverter has three SO239 sockets.



First, remove the cable which is attached to your transceiver's RF output and connect it to the socket on the transverter labeled HF ANT. This cable is carrying RF to your HF antennas or linear amplifier. Locate the coax cable supplied with the transverter. This has PL259 plugs on each end. Connect one end to your transceiver's, now vacant, RF output socket and connect the other end to the centre socket on the transverter. Connect the socket labeled MF ANT to your 630m antenna. This completes the basic installation. Optionally, you may connect your transceiver's keyline output to either of the RCA sockets labeled PTT using the RCA cable supplied. These sockets are wired directly in parallel, with the outer ring grounded. The transverter requires the centre pin of either socket to be grounded to switch the transverter to transmit mode. The centre pins are pulled up to +5 Volts internally through 10K Ohms. Your transceiver's keyline output may already be in use to key an HF linear amplifier. If your linear amplifier's keyline also has a low positive voltage (+3 to +12 Volts) which is grounded on transmit, it will be compatible with the transverter and may be connected to the second RCA socket on the transverter. This will not be the case if the amplifier provides a negative or high voltage switching voltage. If in doubt, seek further advice. If your linear amplifier does share the keyline successfully, you will need to turn off the linear amplifier or put it in standby mode, while operating on 630m. Otherwise the linear amplifier will draw unnecessary current when transmitting on 630m.

## **Operating**

When the toggle switch on the front of the transverter is in the off position, the transverter draws no current and your transceiver is connected to your HF antenna or linear amplifier for normal HF operation. For 630m operation turn on the toggle switch. The screen will light with a brief message and will start receiving on 630m from the signal at the MF ANT socket. Set your transceiver to the 160m band and tune to 1802 to 1809 kHz. You are now listening to signals on 472 to 479 kHz. You may notice a large increase in noise in this frequency range. This is normal. The roofing filter will attenuate signal and noise outside the 630m band. The true frequency of a signal is obtained by ignoring the first three digits of your transceiver's frequency display (180) and replacing them with 47. For example, to receive on the 630m WSPR frequency of 474.2 kHz, set the transceiver dial to 1804.2 kHz.

## **The Display**

There are three sets of screens indicated by different screen colors. The light blue color indicates Receive mode, the light green Transmit mode, and magenta indicates a Menu screen. Rotating the scroll knob selects the parameters to be displayed in each mode. The transmit screens are only displayed when transmitting.

## **The Receive Screens**

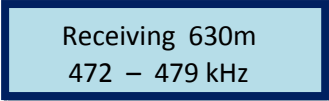

Receiving 630m  
472 - 479 kHz

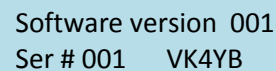

Software version 001  
Ser # 001 VK4YB

This is the main receive display. Pushing the knob briefly displays the Software version, Serial number and your callsign.

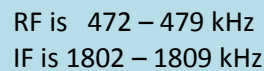

RF is 472 - 479 kHz  
IF is 1802 - 1809 kHz

The next screen is a reminder of the Intermediate Frequency in use. The band is not inverted. USB on 160m is still USB on 630m.

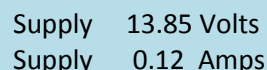

Supply 13.85 Volts  
Supplv 0.12 Amps

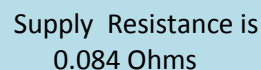

Supply Resistance is  
0.084 Ohms

Supply voltage and current are displayed. To measure the power supply resistance, press the scroll knob. In a short time the supply resistance is displayed. This is especially useful if operating from batteries. Values below 0.1 Ohms are generally satisfactory. Higher values suggest a flat battery or poor connections.

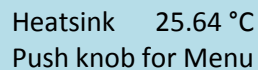

Heatsink 25.64 °C  
Push knob for Menu

The present temperature of the heatsink is displayed. Pushing the knob enters the Menu.

## The Menu Screens

The menu is entered from the Rx screen which shows heat sink temperature. Press the scroll button to enter the menu. All changes are stored in non-volatile memory. There are 5 adjustment screens:

Welcome to the Menu  
Scroll for items

Push to adjust  
screen brightness

Push to enter, and then rotate to adjust screen brightness. Push again to exit and save setting.

Push to adjust  
color balance

Push to enter, and then rotate to adjust red/blue color balance. Push again to exit and save setting.

VOX delay is fast  
Push to select

Set Vox Delay, slow, mid or fast. Select slow or mid for ssb, mid or fast for cw, fast for data. If PTT switching is in use, the Vox Delay setting has no effect, because the transverter returns to receive immediately the PTT line is released.

Rx attenuator = 0dB  
Push to select

Set the 20dB Rx input attenuator, in or out. The attenuator is normally "out", but may be useful in the presence of very local transmitters.

Edit your callsign  
VK4YB

Edit your callsign. This only needs to be done once. The character which has the flashing cursor underneath is changed by rotating the scroll button. Press the scroll button to move to the next character. A character can be deleted by replacing it with a space. Up to 8 characters can be accommodated. Keep pressing the scroll button until a choice is offered to store the changes or revert to the original callsign. New callsigns are added to the provenance list.

Continuing to scroll forward will exit the menu

## The Transmit Screens

The transmit screens are only displayed when transmitting. There are two ways to put the transverter in transmit mode. Either by grounding the PTT line, or by applying RF drive from your transceiver. The transverter is in transmit mode when one of the following screens is displayed.

Output 52.85 Watts  
SWR 1.33 :1

SWR 1.33 :1 (6dB)  
IIII

The main screen in transmit mode displays the output power being delivered to the antenna on the top line. The SWR is shown on the bottom line together with the attenuation, if any, being applied. This screen may be used to adjust the antenna loading coil or antenna matching unit, while observing the SWR numerical value. Alternatively the knob may be pressed to enable the special tune screen, shown above on the right. This shows the SWR in numerical and graphical form for easy antenna tuning. It also turns off the auto SWR protect function and allows the user to manually adjust the TX attenuation using the scroll knob. Rotating anti-clockwise increases attenuation and reduces output power. The purpose of defeating the SWR protect circuit, is to prevent the output power jumping as the SWR varies. This is important if, for example, a remote adjustment is being made to maximize antenna base current. The output transistors can survive operating at full power into a short or open circuit. Nevertheless, it is still wise to commence tuning with the maximum attenuation of 14dB in circuit and only increase power when nearing a match. When tuning is complete, push the knob to return to the normal output screen. This also restores automatic attenuator operation.

Input 3.52 Watts  
Attenuation 0 dB

Drive power is displayed accurately in this screen. Many transceivers have unreliable power meters at low output.

Heatsink 56.55 °C  
Freq 475.62 kHz

The heatsink temperature is displayed. When drive level exceeds 1 watt, the input frequency is measured, and the output frequency is calculated and displayed. The frequency counter works on CW and narrow band signals such as WSPR. The frequency counter does not work on wideband signals such as SSB. When operating wideband modes, the operator must ensure that the entire transmission falls within the legal band.

Supply 13.26 Volts  
Supply 10.86 Amps

Supply voltage and current are displayed. The supply resistance cannot be measured while transmitting.

## Adjusting the Drive Level

The transverter requires approximately 3 to 5 watts of drive from the transceiver for full output power. This will require the power from most transceivers to be reduced from that normally used for HF operation. Depending on the transceiver, this may require adjustment of the power level control, carrier level or mic gain control. If too much power is delivered, the transverter will automatically switch in additional attenuation. The amount of attenuation in use can be seen on the Power output screen. It appears at the end of the second line of the display as a dB value in brackets. If no value is shown, it means the attenuation is 0dB, which is the normal condition. A value of 0dB or occasionally 2dB is permissible. Higher values indicate the transverter is being overdriven and the drive level should be reduced. If the drive power is high enough to overheat the input resistors, the drive power will be automatically switched to bypass mode. This means the input power will be diverted to the HF antenna socket. A warning message will be displayed if this happens. The transverter incorporates automatic transmit-receiver switching. The transverter will automatically switch to transmit mode when RF drive is present. The transverter will drop back to receive after RF is removed and after a delay determined by the VOX delay setting. There are three options, fast, mid or slow, selected in the menu. This auto TX switching is always operative even if the PTT connection is in use, as a safety back-up. However the advantage of using the PTT connection is that switching to RX will occur immediately the PTT line is released.



### Warning Screens

The warning screens are always displayed in red. There are 5 possible screens

RF detected on input  
Signal is bypassed

**RF on input.** This screen will only appear if RF drive is present at start-up. Remove the RF drive and the transverter will continue running-up normally.

Low Supply Volts  
9.42 Volts

**Low Supply voltage.** This will be displayed if the supply voltage falls below 10 Volts. The transverter will still attempt to function but performance will be degraded, especially in transmit mode.

Drive level too high  
Signal is bypassed

**Overdrive.** If the drive level exceeds about 15 watts the input terminating resistors may overheat. Drive power is bypassed to the HF antenna socket. The drive power must be removed completely, to resume normal operation.

Freq above band edge  
freq = 479.02 kHz

**Out of frequency high or low.** Attempts to transmit on a carrier frequency above 479.00 or below 472.00 will result in this screen. Drive power is bypassed to the HF antenna socket. The drive power must be removed and adjusted to an in-band frequency to resume normal operation.

Temp is above 100°C  
Signal is bypassed

Heatsink is cooling  
Temp = 76.84°C

**Over temperature.** If the temperature of the internal heat sink exceeds 100°C, transmission will stop and will not resume until the temperature has fallen below 70°C. Drive power is bypassed to the HF antenna socket until a safe temperature is reached.

### USB Socket

The front panel USB socket is provided for future code up-grades. These will be made available, free-of charge, from the Monitor Sensors web page together with full instructions. The USB socket has a dust cover which should be kept in place, when not in use.

## Theory of Operation

In receive, signals from the MF Antenna pass through the SWR Bridge and 7 pole, Chebychev, 500 kHz, low pass filter. This filter provides 30 to 50 dB of attenuation against Broadcast Stations operating in the 550 to 1600 kHz Medium Wave Band. This filter is followed by a half lattice, roofing filter. The pass band is 472 to 479 kHz. The filter is steep sided, but flat within +/- 1.5 dB within the pass band. The ceramic elements resonate at 473.3 and 478.2 kHz. The roofing filter is followed by a 5 pole chebychev low pass filter. At this point the RF signals have not encountered any active or non-linear devices, which might cause intermodulation products. The next stage is the double balanced commutating mixer. The mixer is fed by a MEMS local oscillator operating at 1.33 MHz. This oscillator has extremely low phase noise and is temperature compensated by its own dedicated micro-processor. The following 3 pole Chebychev 1.8 Mhz Band Pass Filter selects the desired mixer product before amplification by a current feedback video op-amp. The op-amp combines low noise operation with ultra linear performance and incorporates a protection circuit to prevent damage, even in the event of 100 watts of RF, fed accidentally into its output port.

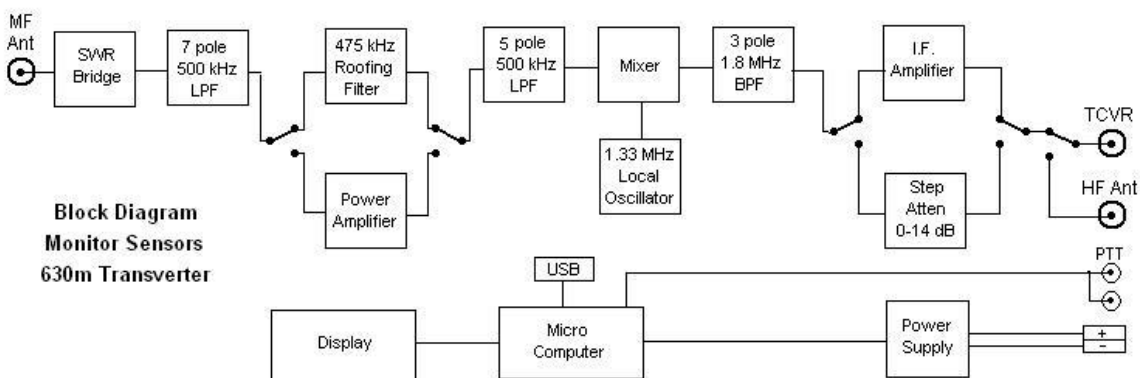

In transmit, signals from the transceiver pass through a 0 - 14 dB step attenuator, which is under control of the micro-computer. Signals that would tend to overload the Power Amplifier are attenuated at this point. Attenuation is also increased in the event of high output SWR. From the step attenuator the signals pass through the mixer and its associated filters to the input of the Power Amplifier. The Power Amplifier has a gain of 50dB, and employs six lateral FETs in class AB, push-pull. Lateral FETs are inherently linear and thermally stable. The output passes through the 7 pole, Chebyshev low pass filter, which reduces all harmonics to better than -50dB. Finally the signal passes through the SWR bridge. Measurements made in the SWR bridge enable the micro-computer to calculate the power delivered to the load and the SWR at the output socket.

## **Specifications**

RF frequency range	472 to 479 kHz
IF frequency range	1802 to 1809 kHz (others available in the 160m band)
Transmission modes	CW, SSB, WSPR, all other data modes
Output Power	50 Watts Continuous, 100% duty cycle
Input and Output Impedance	50 Ohms
Supply voltage	13.8 VDC @ 15 Amps nominal, 10-16 VDC operational
Rx noise floor	-125 dBm in 500Hz band width
Rx 3dB compression point	15 dBm (Rx attenuator out)
Rx IF rejection	better than 75dB
Rx conversion gain	6dB nominal
Roofing filter in-band ripple	+/- 1.5dB, 472 to 479 kHz
Tx 3 <sup>rd</sup> order IMD	-33 dB typical below PEP
Tx 5 <sup>th</sup> order IMD	-45dB typical below PEP
Tx harmonics and spuri	All better than -50dB
Tx conversion gain	10dB nominal
Power input connector	2 * Anderson Power Poles (one Power cable supplied)
RF connectors	3 * SO239 (one PL259 to PL259 cable supplied)
PTT connectors	2 * RCA (one RCA to RCA cable supplied)
USB connector	Micro B USB, (matching cable supplied)
Dimensions	12½ * 4¼ * 3 inches
Weight	3.4 lbs

## **Warranty**

Monitor Sensors products are covered by a warranty which warrants "that all equipment supplied is free from defects in material and workmanship for a period of **one year** from the date of delivery from the works, providing there is no evidence of abnormal use. The obligation under the warranty is limited to replacing or repairing, at our option, any of the items so determined to be defective. The warranty shall not apply to any item that has been repaired or altered by others or which has been subjected to misuse." Customers should contact our service department ([service@monitorsensors.com](mailto:service@monitorsensors.com)) before returning goods.

Monitor Sensors (Aust) Pty Ltd  
1/42 Cessna Drive  
Caboolture  
Queensland 4510  
Australia  
[sales@monitorsensors.com](mailto:sales@monitorsensors.com)

Tel +61-7-5428 5900  
Fax +61-7-5495 2276