

SECTION 10

BLOCK DIAGRAM

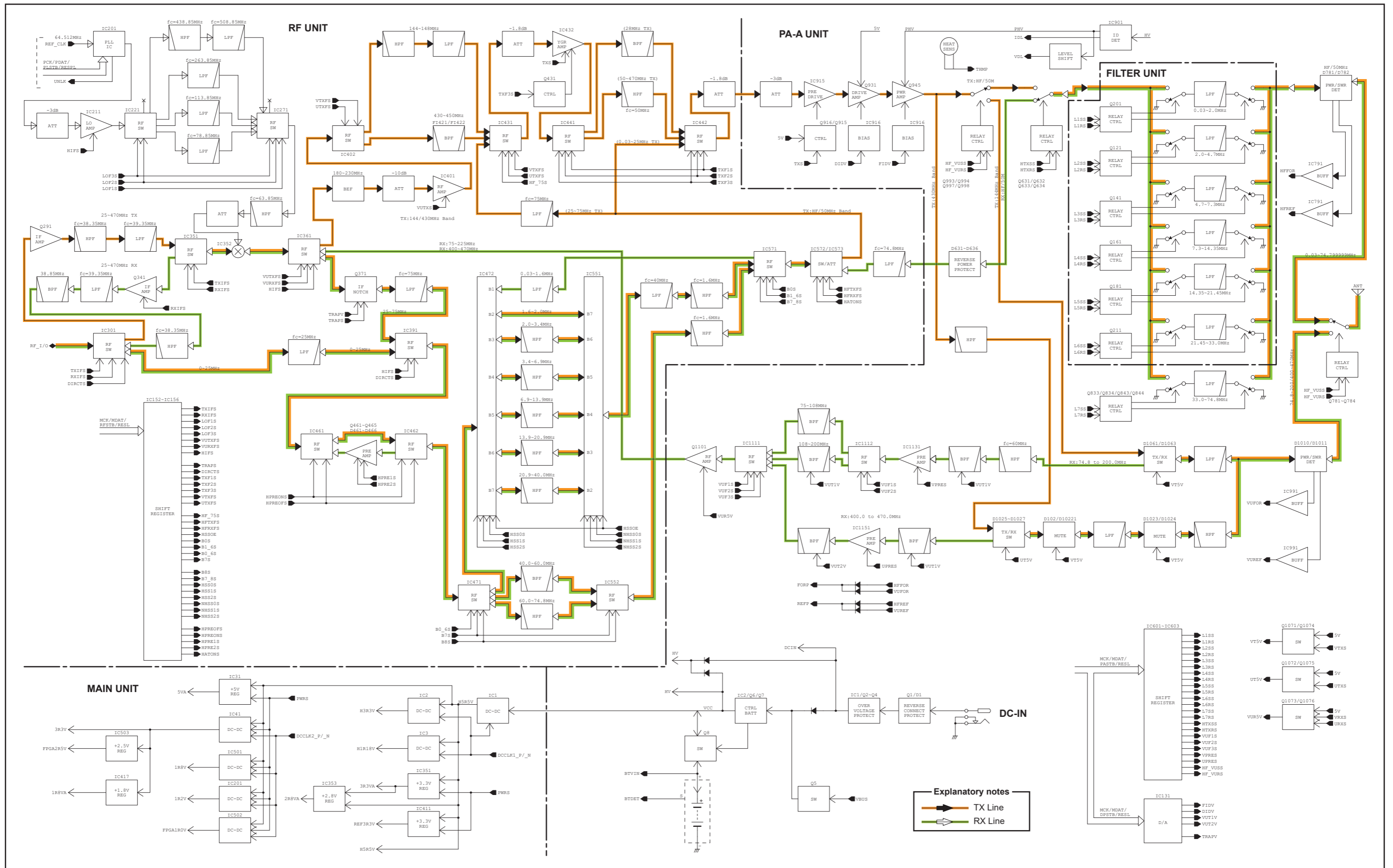

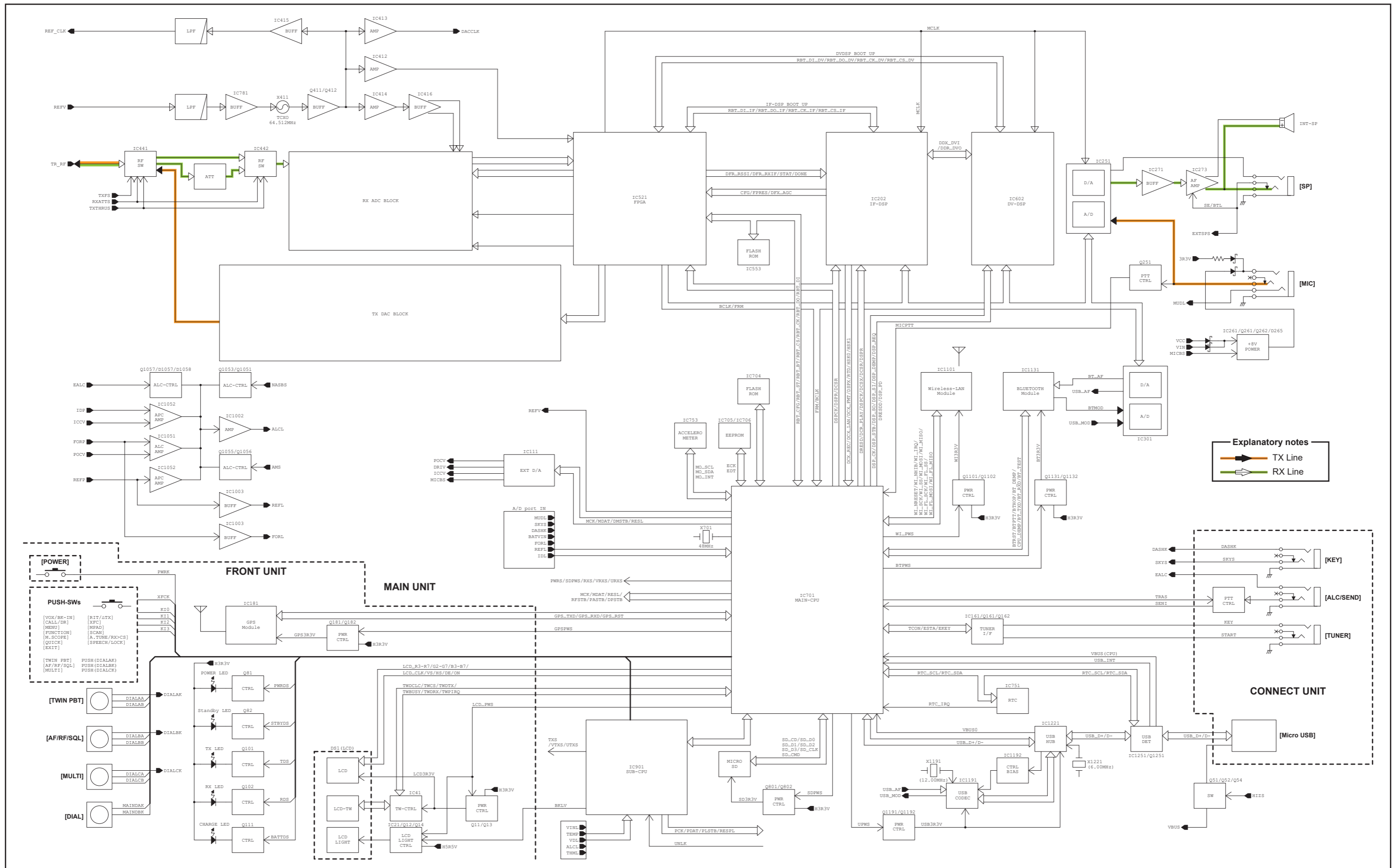

• DISPLAY UNIT

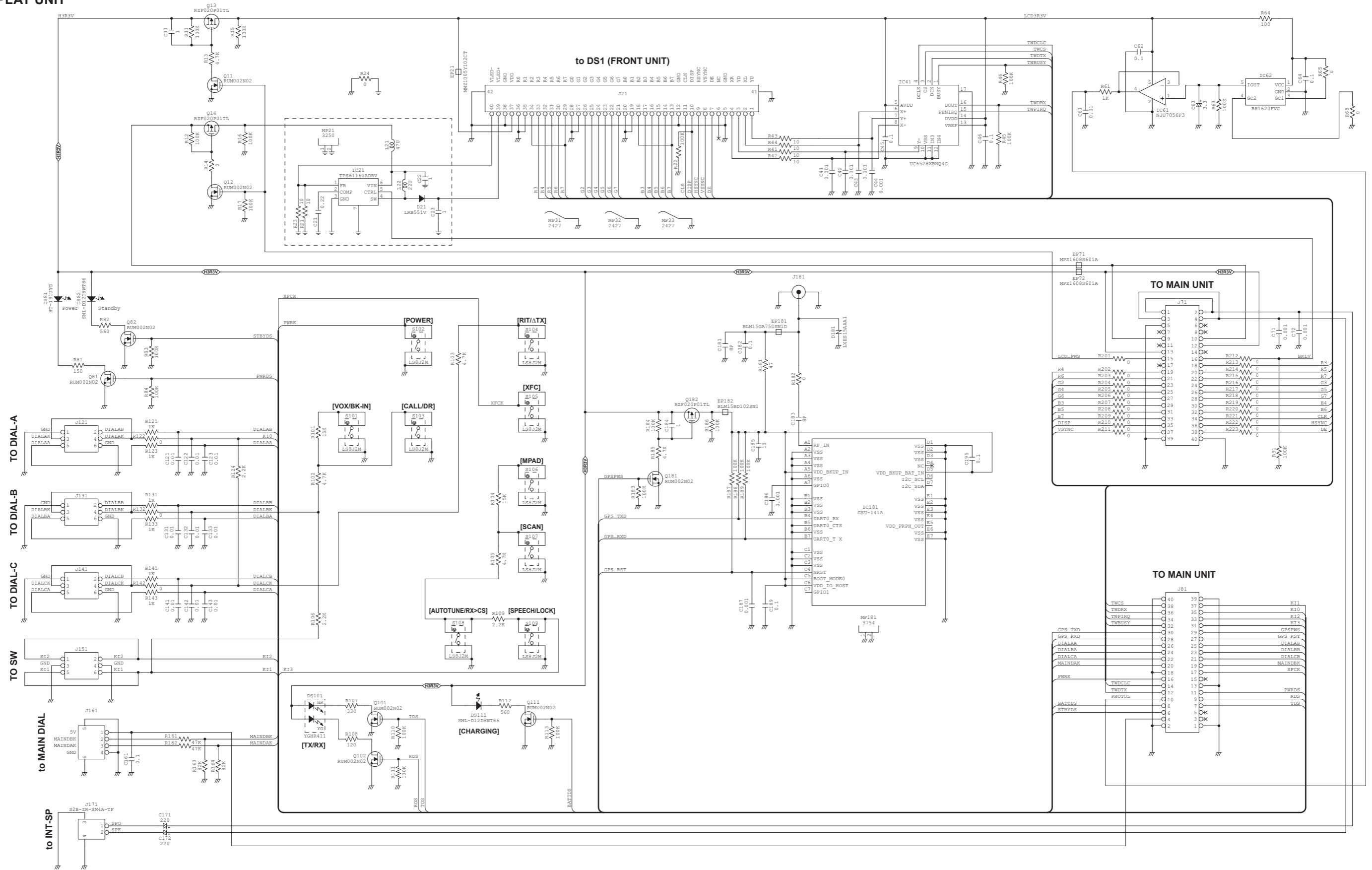

• FRONT UNIT

• DIAL-A UNIT

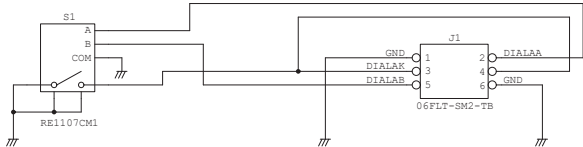

• DIAL-B UNIT

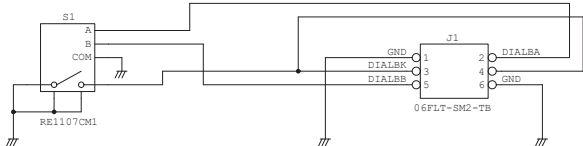

• DIAL-C UNIT

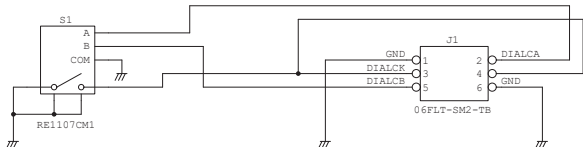

• MAIN UNIT (1/8)

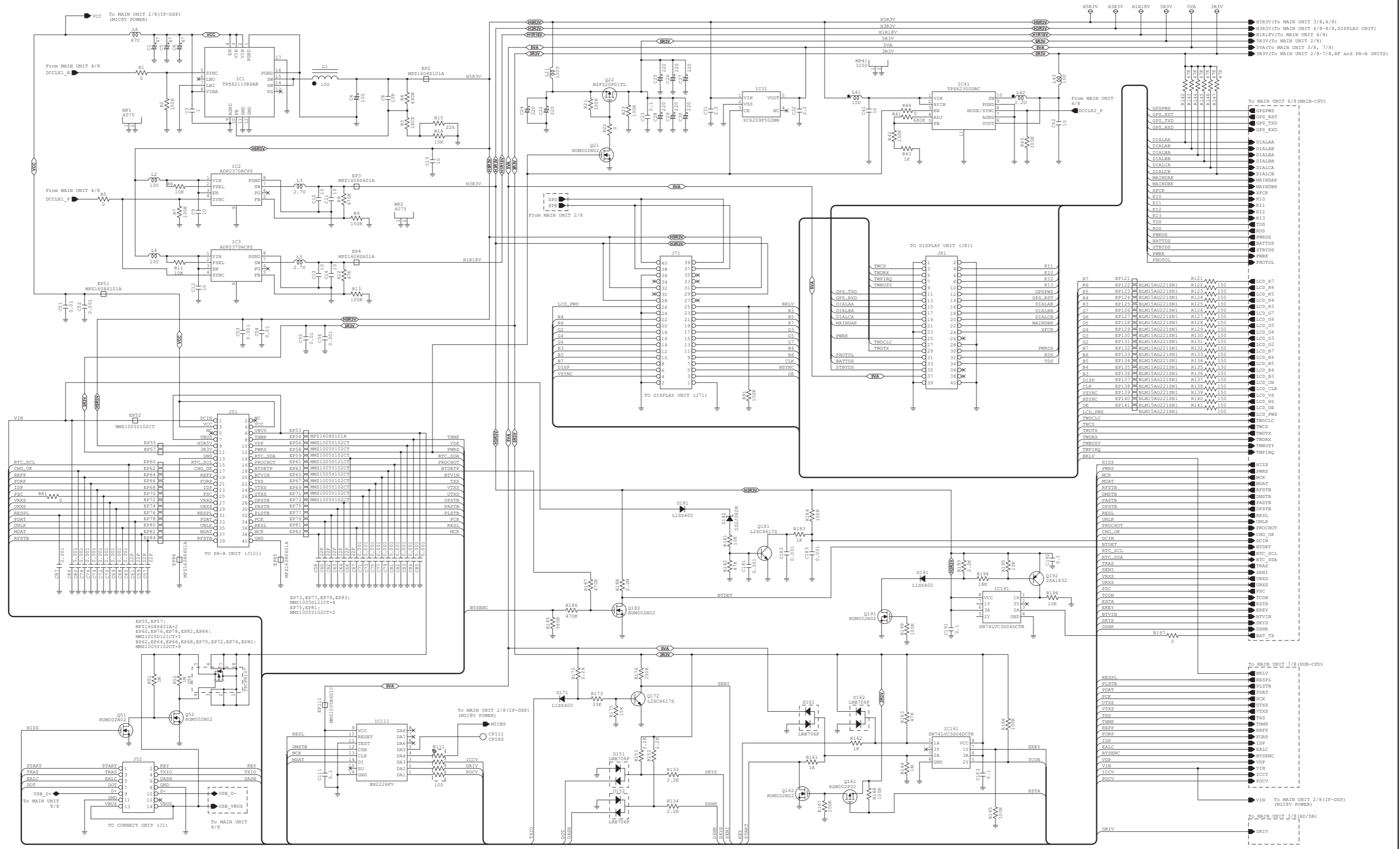

• MAIN UNIT (2/8)

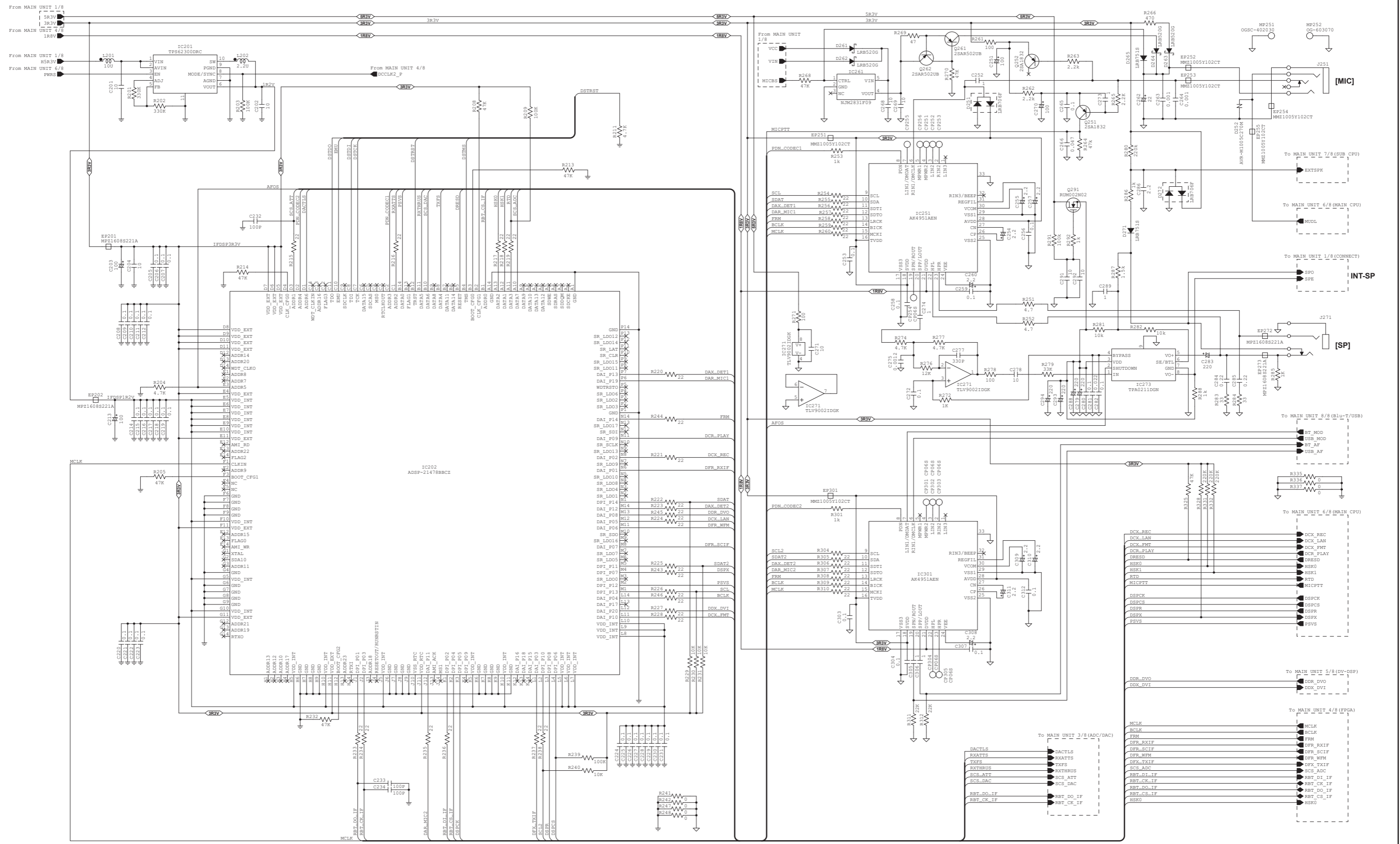

• MAIN UNIT (3/8)

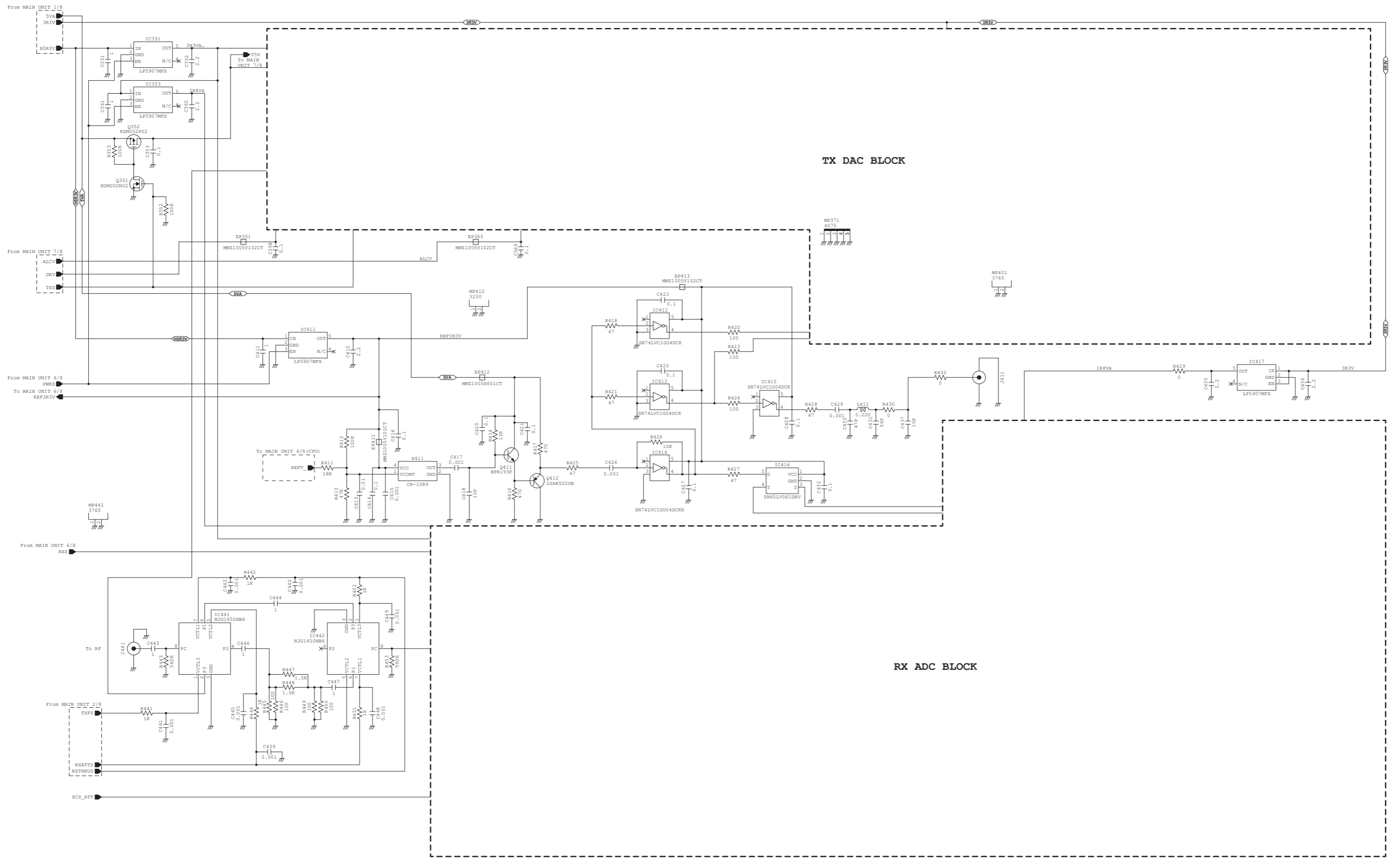

• MAIN UNIT (4/8)

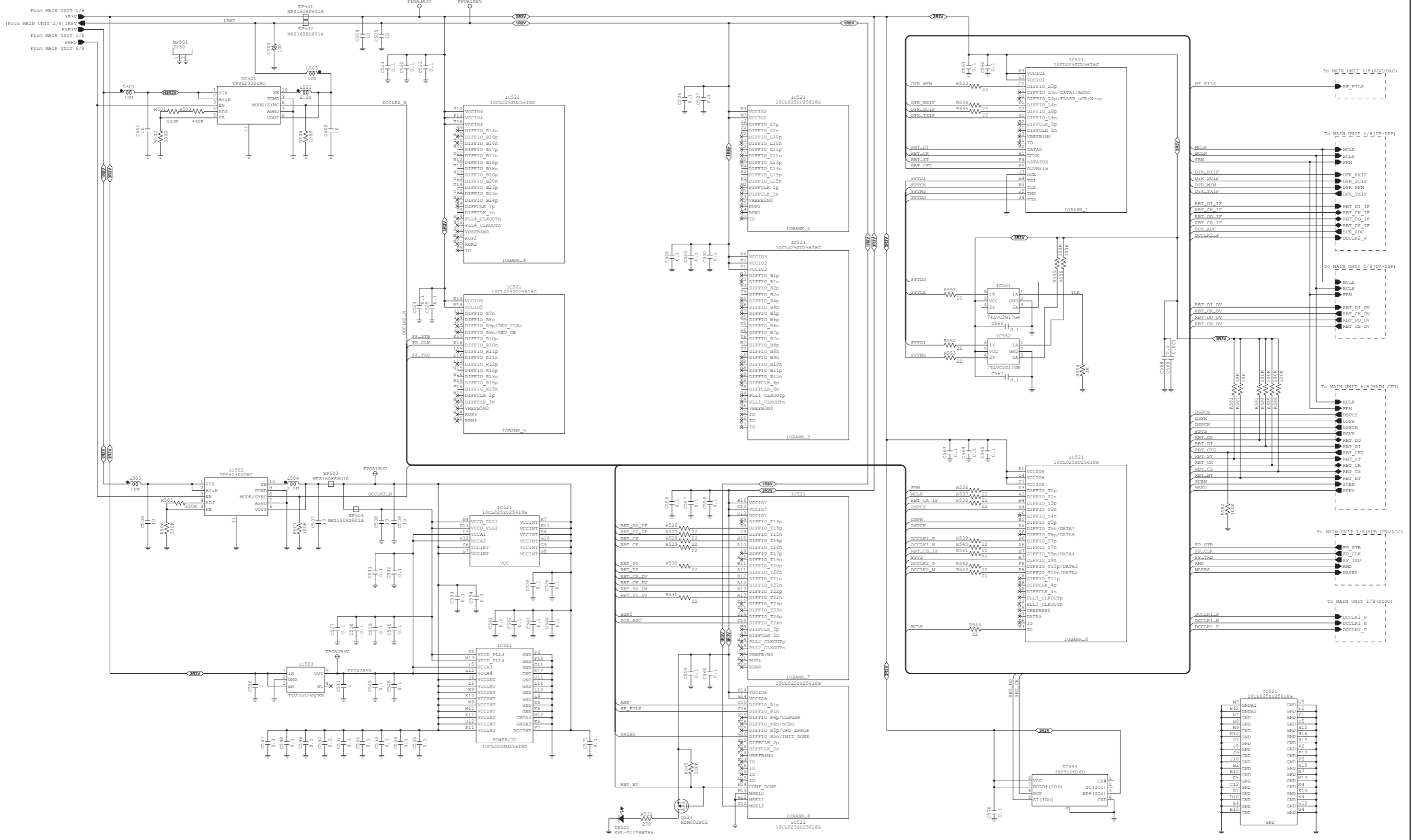

• MAIN UNIT (5/8)

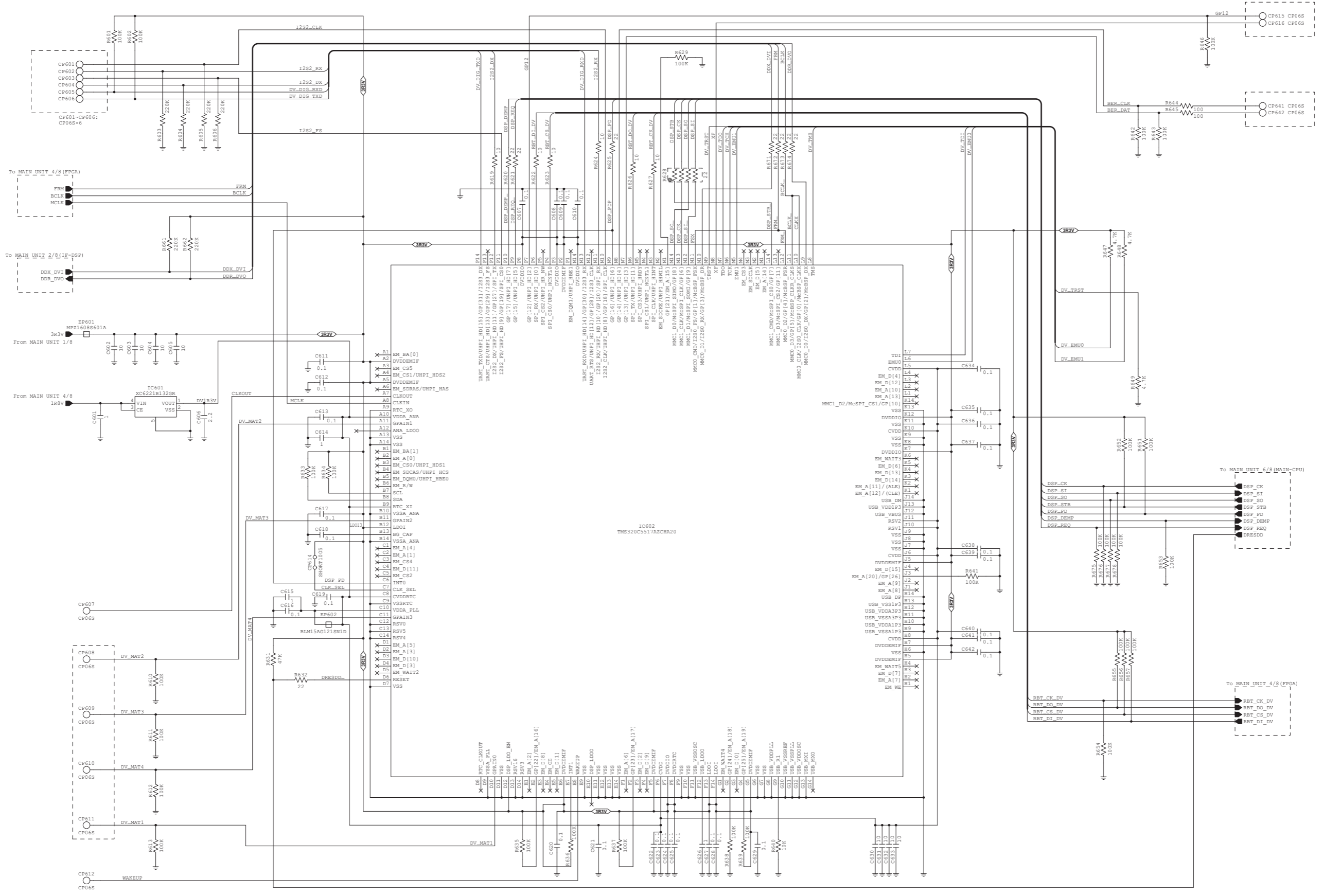

• MAIN UNIT (7/8)

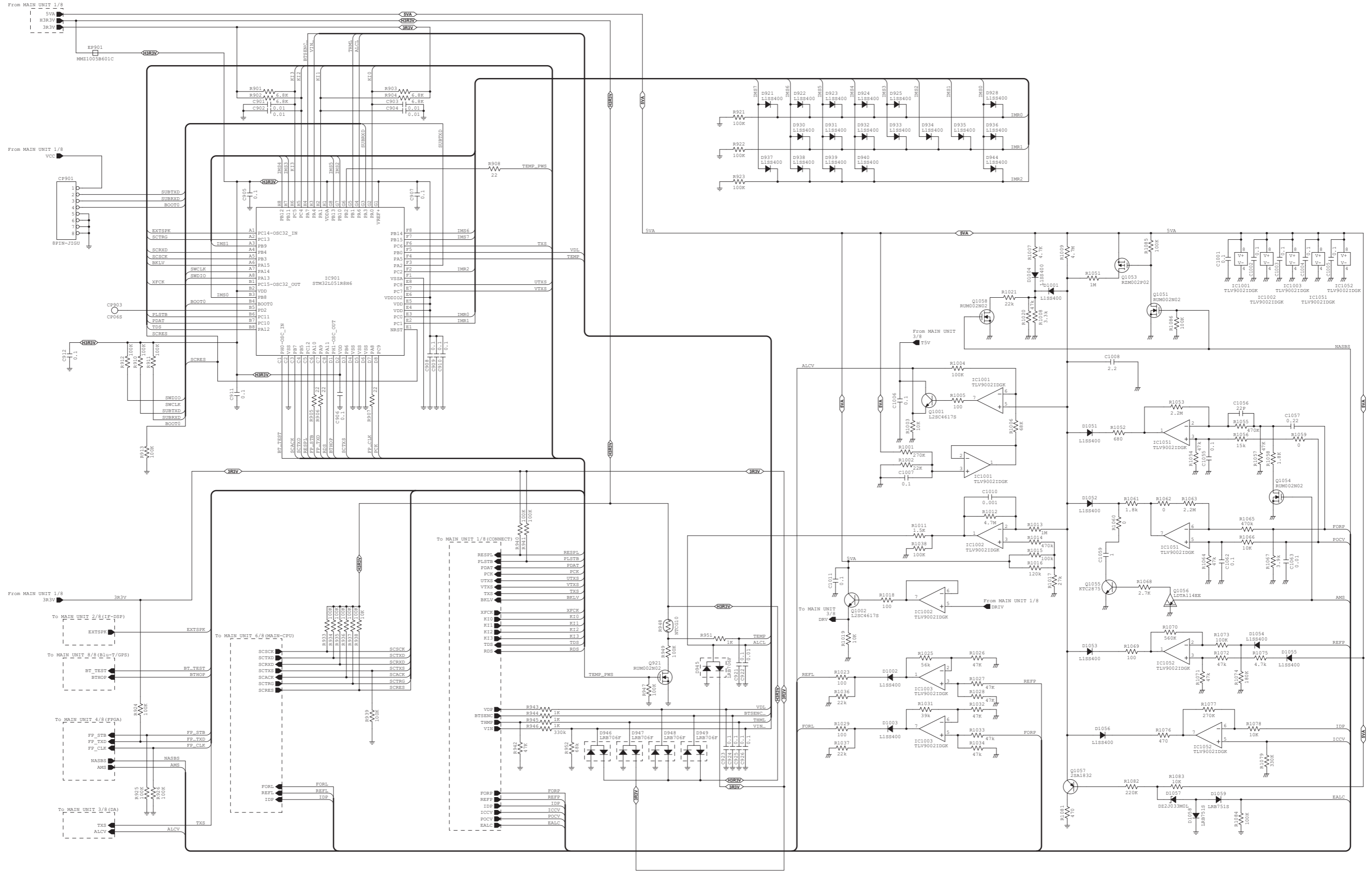

• MAIN UNIT (8/8)

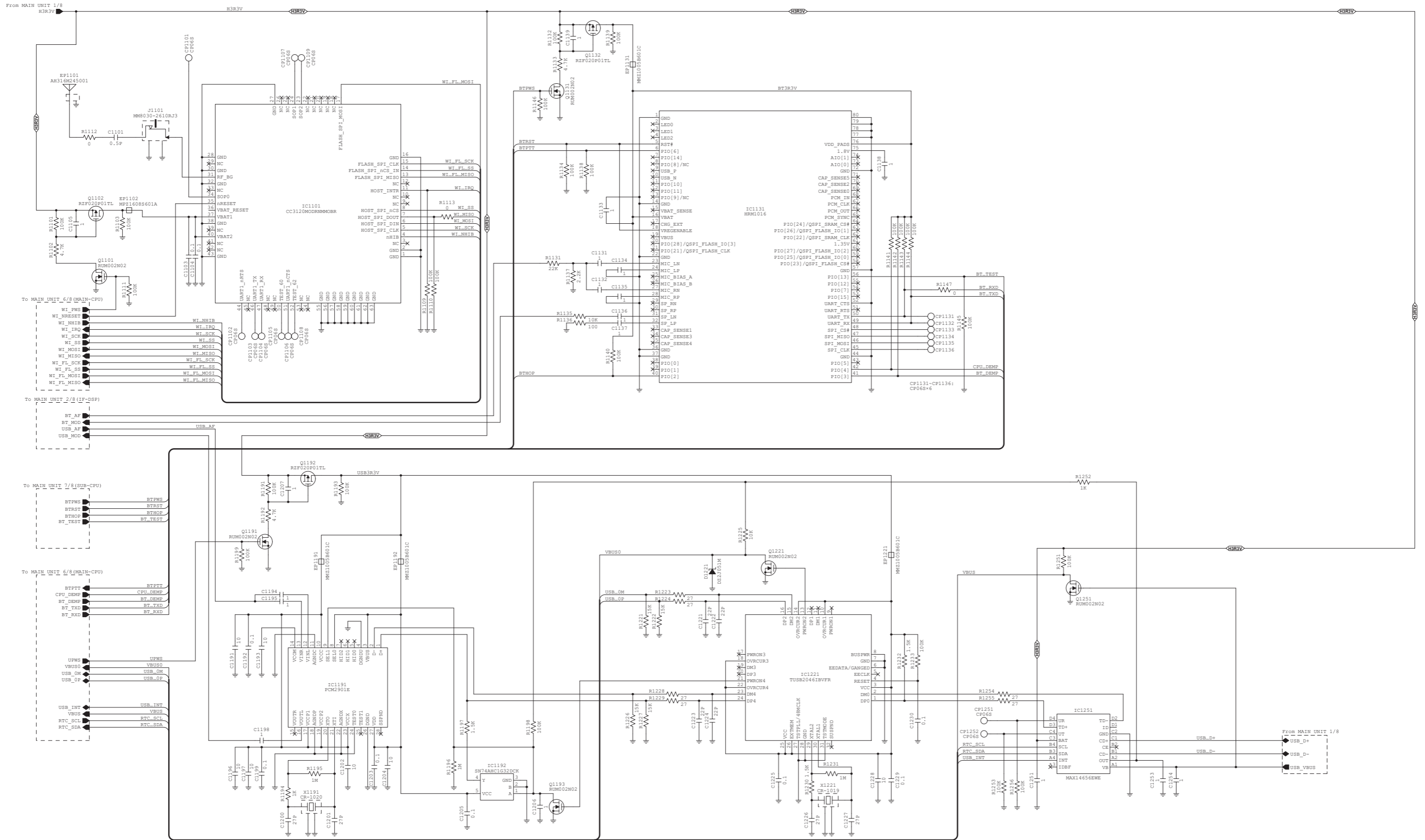

• CONNECT UNIT

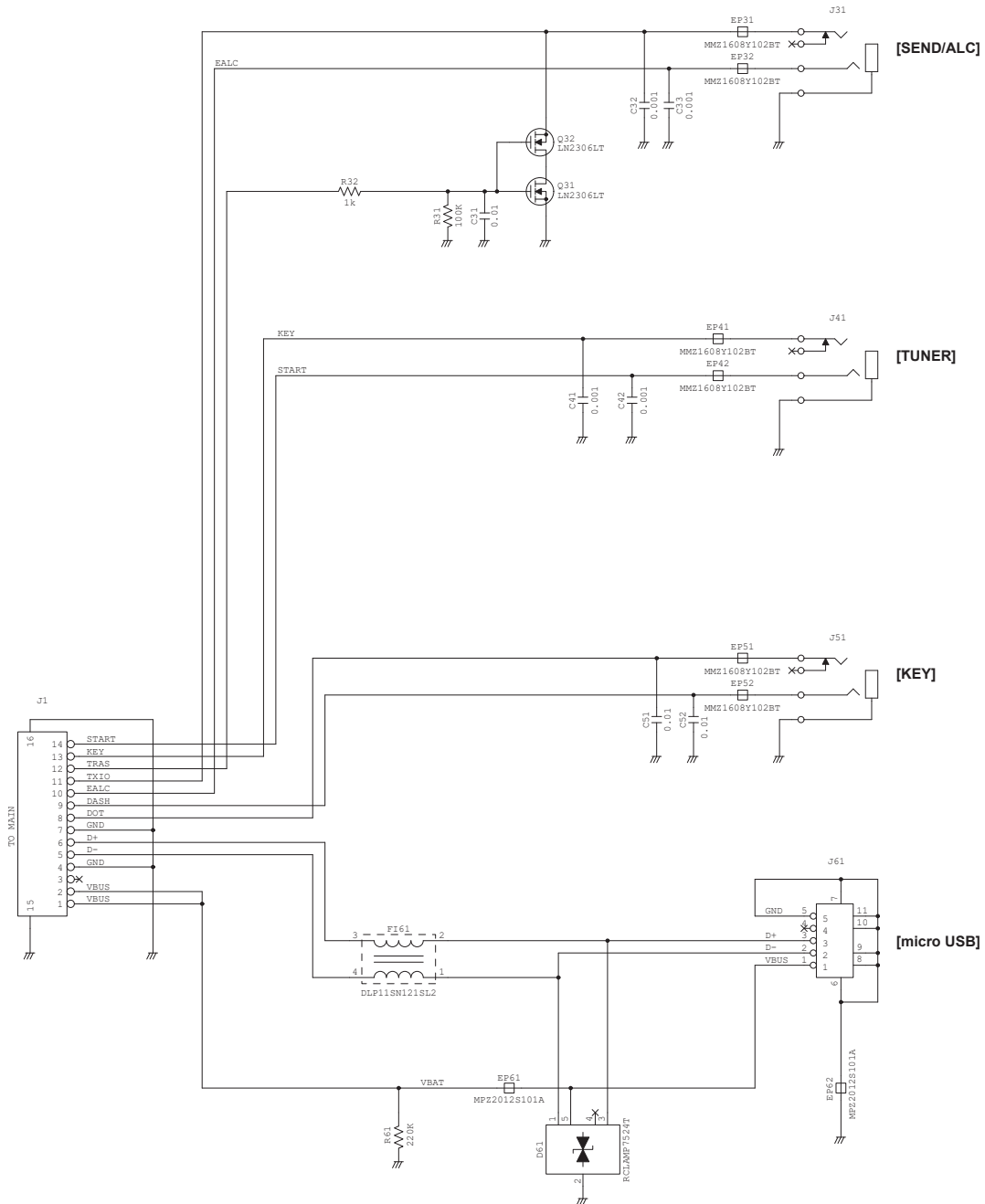

• RF UNIT (1/3)

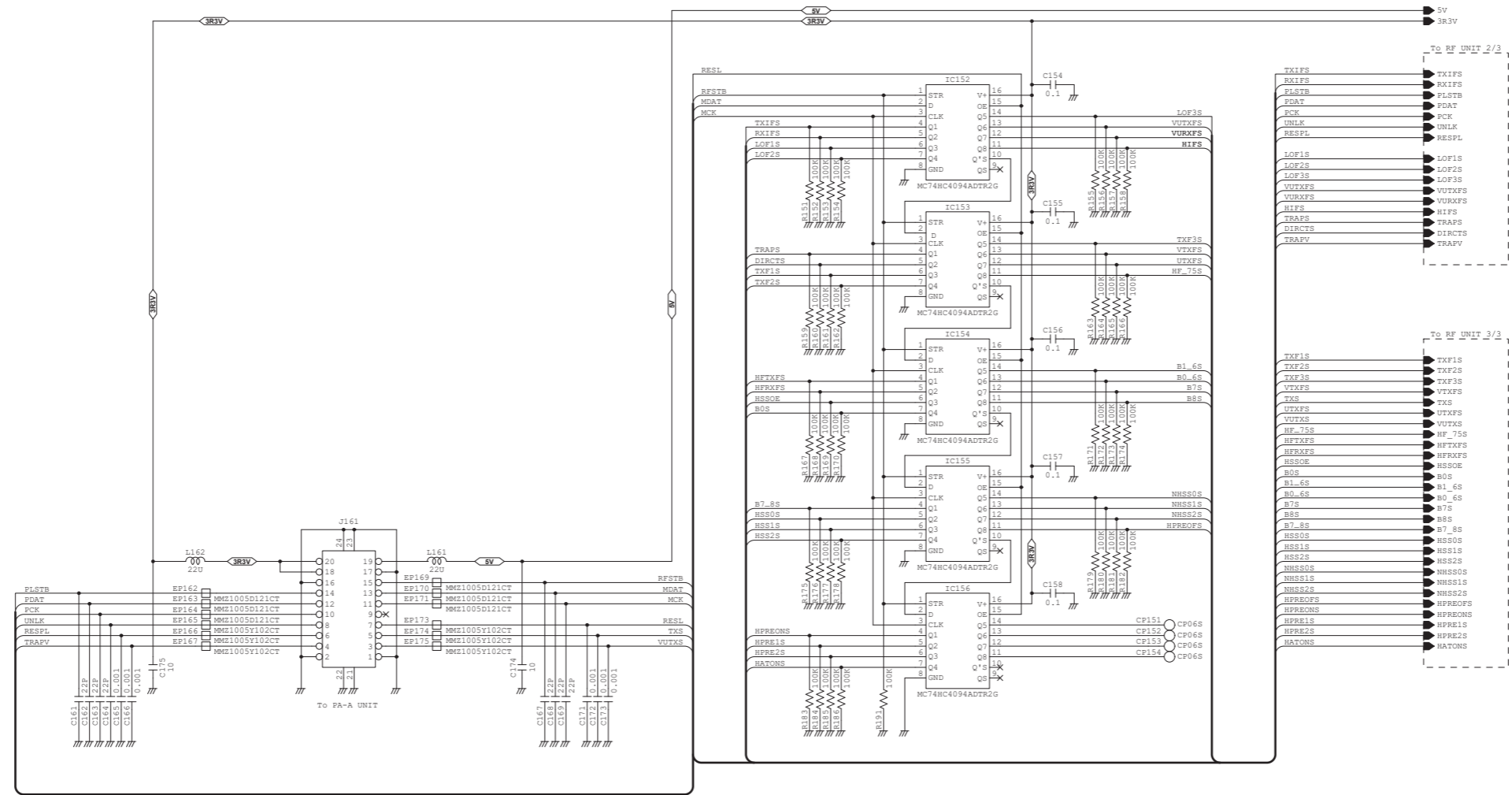

• RF UNIT (2/3)

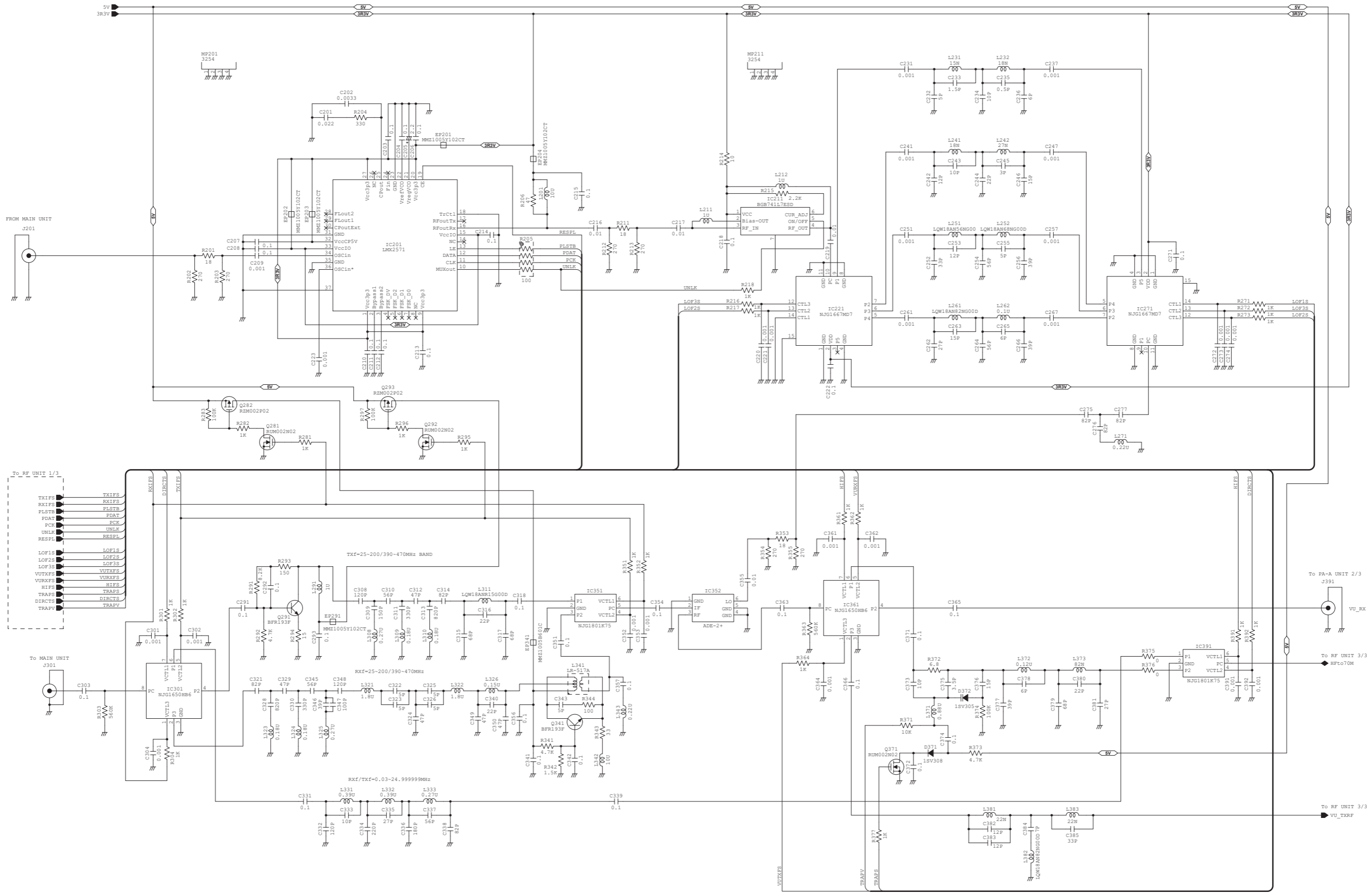

• RF UNIT (3/3)

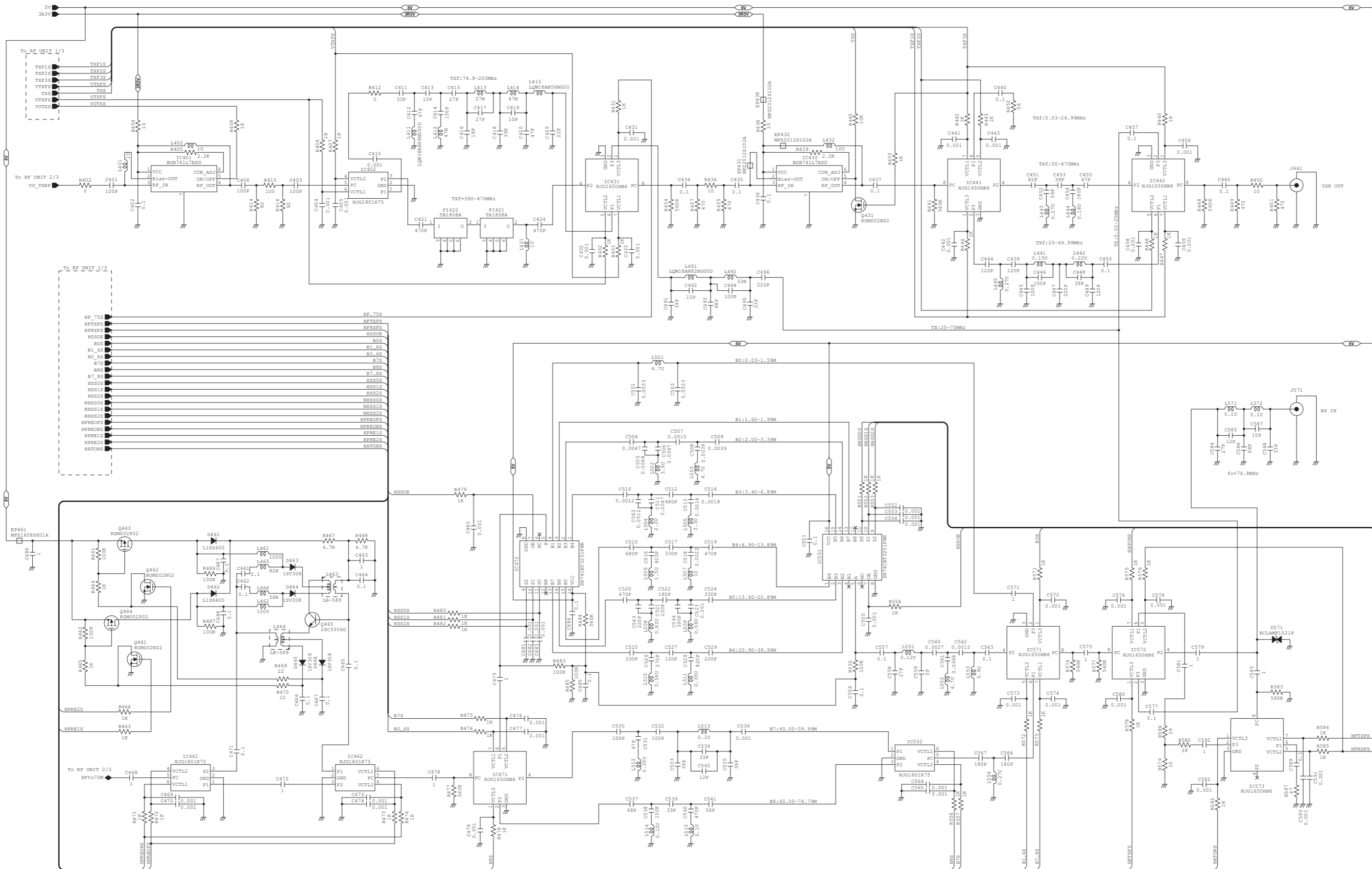

• PA-A UNIT (1/3)

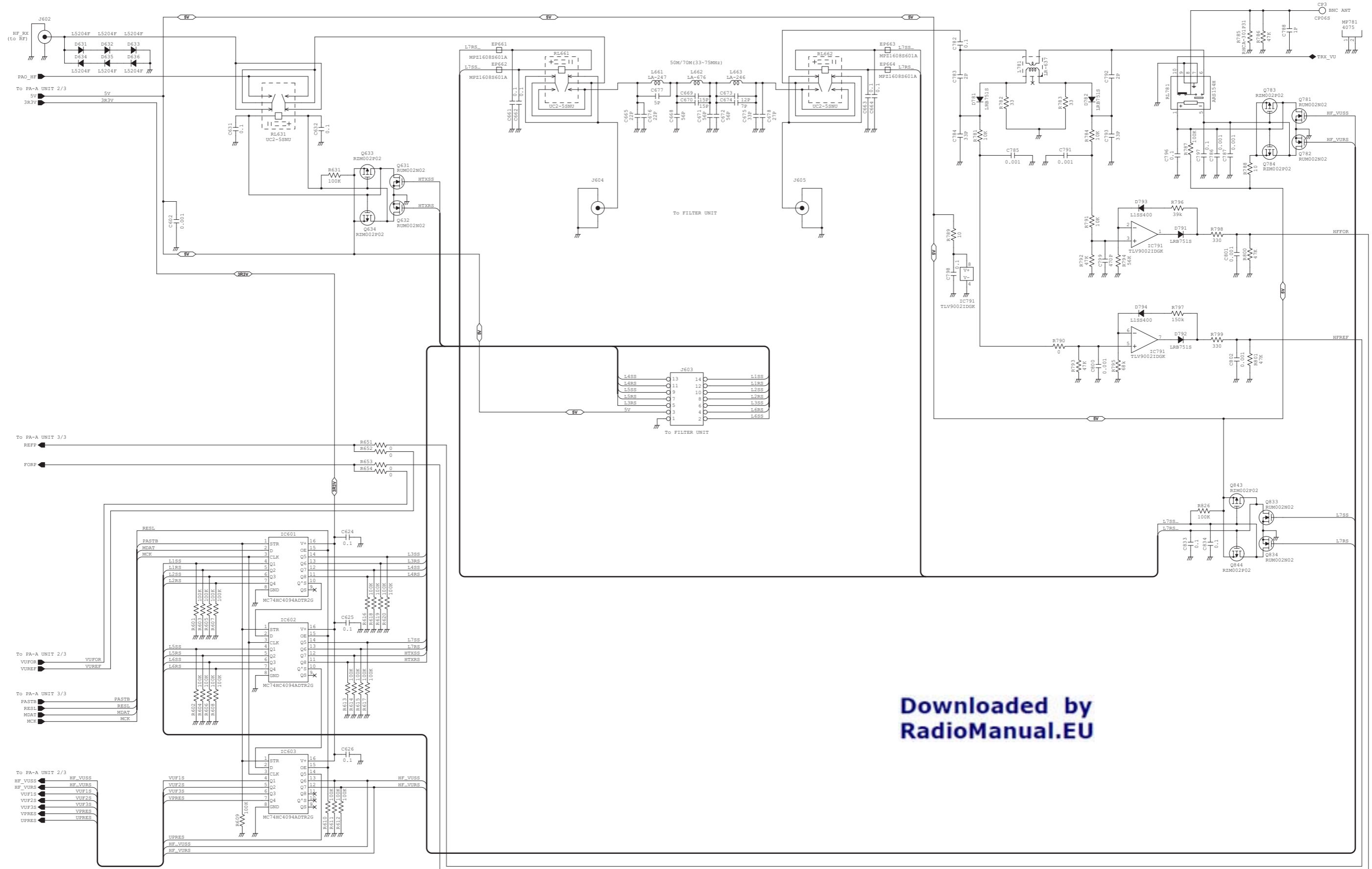

Downloaded by
RadioManual.EU

• PA-A UNIT (3/3)

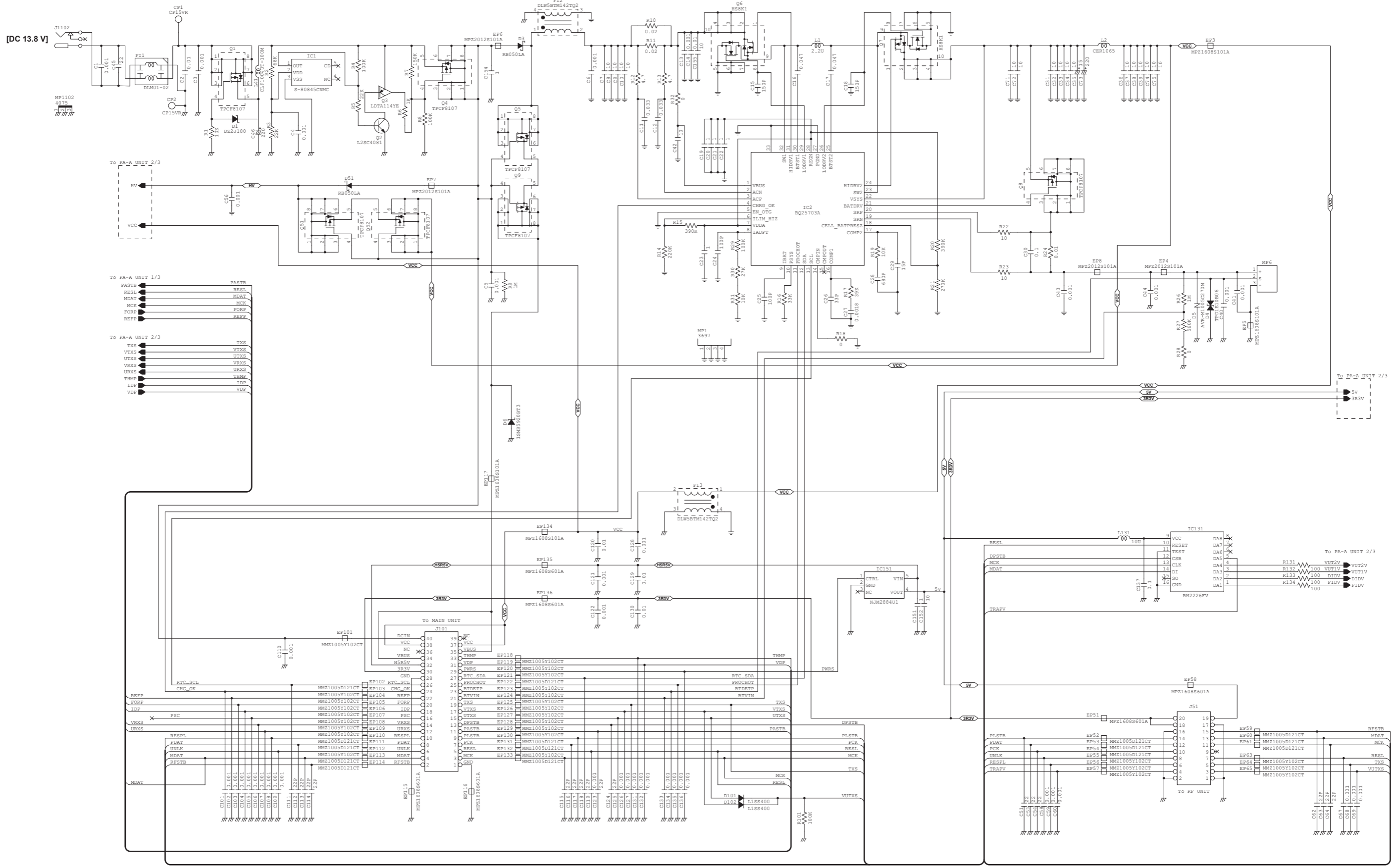

• FILTER UNIT

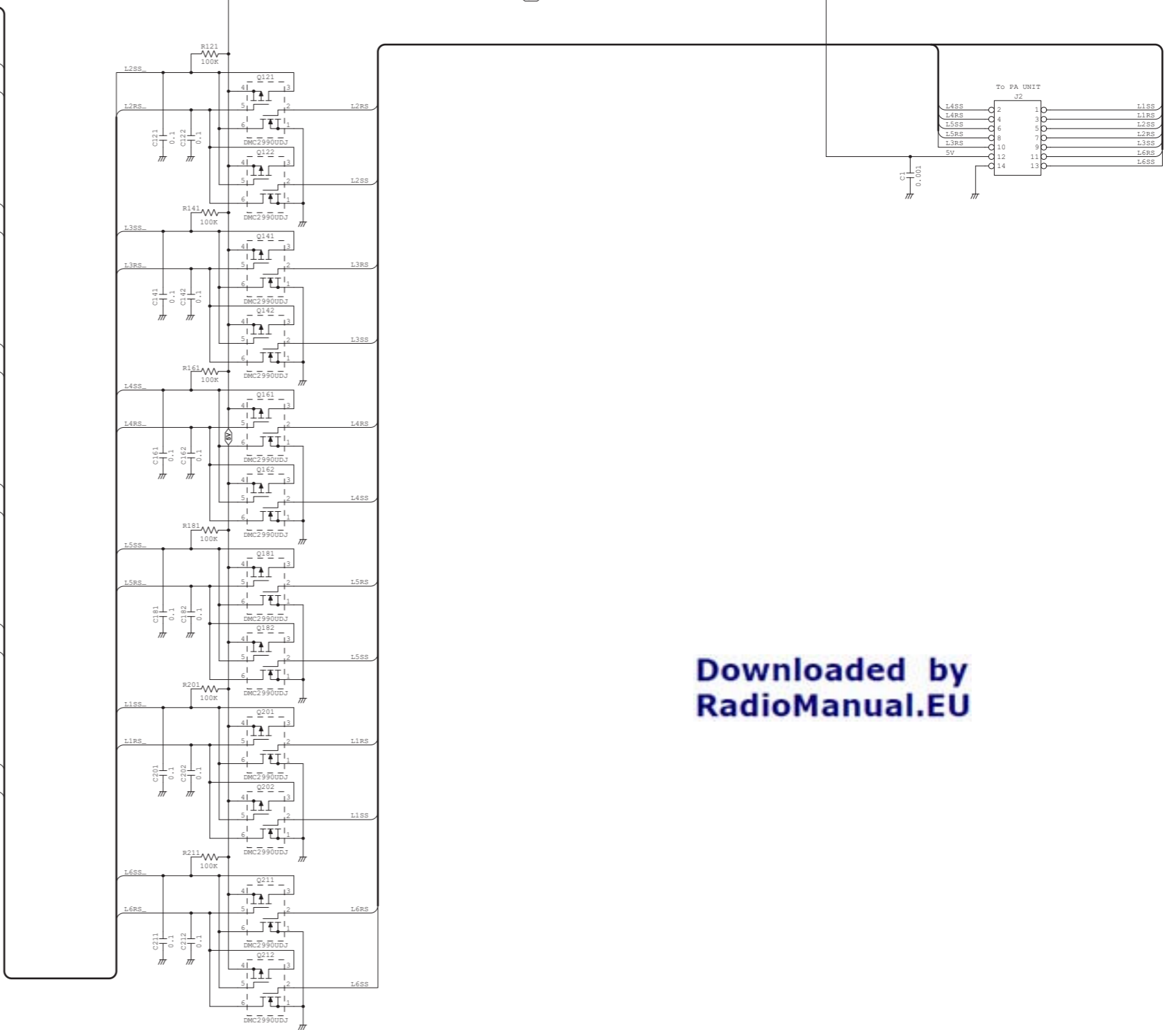
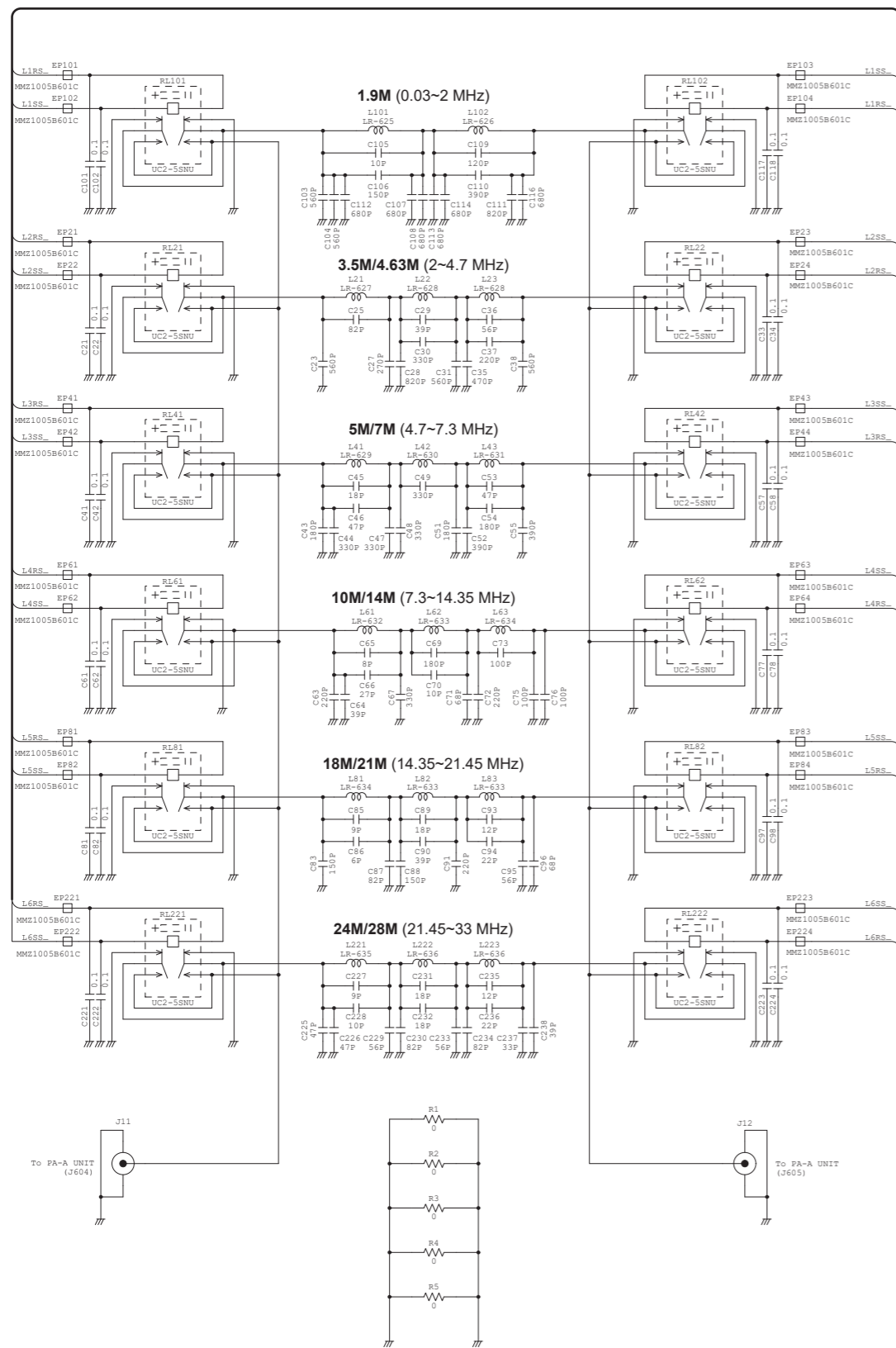

Downloaded by
RadioManual.EU