



BASIC MANUAL

HF ALL BAND TRANSCEIVER
IC-718



Thank you for choosing this Icom product. This product was designed and built with Icom's state of the art technology and craftsmanship. With proper care, this product should provide you with years of trouble-free operation.

IMPORTANT

READ ALL INSTRUCTIONS carefully and completely before using the transceiver.

SAVE THIS INSTRUCTION MANUAL— This instruction manual contains basic operating instructions for the IC-718.

The detailed manual (PDF type) can be downloaded from the following internet address:

<https://www.icomjapan.com/support/>

SUPPLIED ACCESSORIES

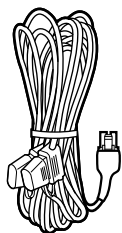

DC power cable
(3 m: 9.8 ft)

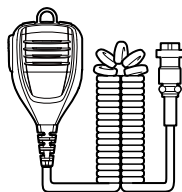

Microphone



Spare fuse (FGB 125 V/4 A)
Internal fuse



Spare fuses (ATQ 32 V/25 A)
for the DC power cable

① Some accessories are not supplied, or the shape is different, depending on the transceiver version.

About weld lines

This product's surfaces may have streaks called "weld lines," that occur during the molding process, and are not cracks or flaws.

Icom is not responsible for the destruction, damage to, or performance of any Icom or non-Icom equipment, if the malfunction is because of:

- Force majeure, including, but not limited to, fires, earthquakes, storms, floods, lightning, or other natural disasters, disturbances, riots, war, or radioactive contamination.
- The use of Icom transceivers with any equipment that is not manufactured or approved by Icom.

EXPLICIT DEFINITIONS

| WORD | DEFINITION |
|-------------------|--|
| ⚠ DANGER! | Personal death, serious injury or an explosion may occur. |
| ⚠ WARNING! | Personal injury, fire hazard or electric shock may occur. |
| CAUTION | Equipment damage may occur. |
| NOTE | Recommended for optimum use. No risk of personal injury, fire or electric shock. |

PRECAUTIONS

⚠ **DANGER HIGH VOLTAGE! NEVER** touch an antenna or antenna connector while transmitting. This could cause an electrical shock or burn.

⚠ **DANGER! NEVER** operate the transceiver near unshielded electrical blasting caps or in an explosive atmosphere. This could cause an explosion and death.

⚠ **DANGER! NEVER** place the transceiver where air bag deployment may be obstructed during mobile operations.

⚠ **WARNING RF EXPOSURE!** This transceiver emits Radio Frequency (RF) energy. Extreme caution should be observed when operating this transceiver. If you have any questions regarding RF exposure and safety standards, please refer to the Federal Communications Commission Office of Engineering and Technology's report on Evaluating Compliance with FCC Guidelines for Human Radio Frequency Electromagnetic Fields (OET Bulletin 65).

⚠ **WARNING! NEVER** operate the transceiver with earphones or other audio accessories at high volume levels. The continuous high volume operation may cause a ringing in your ears. If you experience ringing, reduce the volume level or discontinue use.

⚠ **WARNING! NEVER** apply AC power to the [DC 13.8 V] socket on the transceiver rear panel. This could cause a fire or damage the transceiver.

⚠ **WARNING! NEVER** apply more than 16 V DC to the [DC 13.8 V] socket on the transceiver rear panel. This could cause a fire or damage the transceiver.

⚠ **WARNING! NEVER** reverse the DC power cable polarity. This could cause a fire or damage the transceiver.

⚠ **WARNING! NEVER** remove the fuse holder on the DC power cable. Excessive current caused by a short could cause a fire or damage the transceiver.

⚠ **WARNING! NEVER** let metal, wire, or other objects contact the transceiver inside or make incorrect contact with connectors on the rear panel. This could cause an electric shock or damage the transceiver.

⚠ **WARNING! NEVER** operate or touch the transceiver with wet hands. This could cause an electric shock or damage the transceiver.

⚠ **WARNING! NEVER** operate the equipment if you notice an abnormal odor, sound, or smoke. Immediately turn OFF the power and/or remove the DC power cable. Contact your Icom dealer or distributor for advice.

⚠ **WARNING! NEVER** operate the transceiver during a lightning storm. It may result in an electric shock, cause a fire or damage the transceiver. Always disconnect the power source and antenna before a storm.

⚠ **WARNING! NEVER** place the transceiver where the vehicle's normal operation may be hindered or where it could cause bodily injury.

⚠ **WARNING! NEVER** put the transceiver in an unstable place where the transceiver may suddenly move or fall. This could cause an injury or damage the transceiver.

CAUTION: DO NOT operate the transceiver while driving a vehicle. Safe driving requires your full attention—anything less may result in an accident.

CAUTION: DO NOT expose the transceiver to rain, snow or any liquids. They could damage the transceiver.

CAUTION: DO NOT change the internal settings of the transceiver. This may reduce transceiver performance and/or damage to the transceiver. The transceiver warranty does not cover any problems caused by unauthorized internal adjustments.

CAUTION: DO NOT install or place the transceiver in a place without adequate ventilation, or block any cooling vents on the top, rear, sides or bottom of the transceiver. Heat dissipation may be reduced and damage the transceiver.

CAUTION: DO NOT use harsh solvents such as benzine or alcohol to clean the transceiver, as they will damage the transceiver's surfaces. If the transceiver becomes dusty or dirty, wipe it clean with a soft, dry cloth.

CAUTION: DO NOT leave the transceiver in areas with temperatures below -10°C ($+14^{\circ}\text{F}$) or above $+60^{\circ}\text{C}$ ($+140^{\circ}\text{F}$), or in areas subject to direct sunlight, such as the dashboard.

CAUTION: DO NOT place the transceiver in excessively dusty environments. This could damage the transceiver.

BE CAREFUL! The transceiver may become hot after continuously transmitting for long periods of time.

CAUTION: DO NOT set the transceiver's RF output power to more than a connected linear amplifier's maximum input level. Otherwise, the linear amplifier will be damaged.

CAUTION: DO NOT use non-Icom microphones. Other microphones have different pin assignments, and may damage the transceiver.

NEVER place the transceiver in an insecure place to avoid inadvertent use by unauthorized persons.

During mobile operation, **NEVER** place the transceiver where hot or cold air blows directly onto it.

CAUTION: DO NOT operate the transceiver without running the vehicle's engine. The vehicle's battery will quickly run out when the transceiver is used while the vehicle's engine is OFF.

CAUTION: DO NOT start the vehicle engine when the transceiver's power is ON. Ignition voltage spikes can damage the transceiver.

NOTE: During maritime mobile operations, keep the transceiver and microphone as far away as possible from the magnetic navigation compass to prevent erroneous indications.

TRADEMARKS

Icom and the Icom logo are registered trademarks of Icom Incorporated (Japan) in Japan, the United States, the United Kingdom, Germany, France, Spain, Russia, Australia, New Zealand, and/or other countries.

All other products or brands are registered trademarks or trademarks of their respective holders.

FCC INFORMATION

This equipment has been tested and found to comply with the limits for a Class B digital device, pursuant to part 15 of the FCC Rules.

These limits are designed to provide reasonable protection against harmful interference in a residential installation. This equipment generates, uses and can radiate radio frequency energy and, if not installed and used in accordance with the instructions, may cause harmful interference to radio communications. However, there is no guarantee that interference will not occur in a particular installation. If this equipment does cause harmful interference to radio or television reception, which can be determined by turning the equipment off and on, the user is encouraged to try to correct the interference by one or more of the following measures:

- Reorient or relocate the receiving antenna.
- Increase the separation between the equipment and receiver.
- Connect the equipment into an outlet on a circuit different from that to which the receiver is connected.
- Consult the dealer or an experienced radio/TV technician for help.

CAUTION: Changes or modifications to this device, not expressly approved by Icom Inc., could void your authority to operate this device under FCC regulations.

◇ FCC SDoC

This device complies with part 15 of the FCC Rules. Operation is subject to the condition that this device does not cause harmful interference.

Responsible Party

Company Name: Icom America Inc.
Address: 12421 Willows Road NE Kirkland, WA 98034

U.S. Contact Information

800-USA-ICOM (800-872-4266)
Monday – Friday 7 AM to 5 PM PST

For Canada:

This device contains licence-exempt transmitter(s)/ receiver(s) that comply with Innovation, Science and Economic Development Canada (ISED)'s licence exempt RSS(s). Operation is subject to the following two conditions:

- (1) this device may not cause interference, and
- (2) this device must accept any interference, including interference that may cause undesired operation of the device.

TABLE OF CONTENTS

| | |
|---|-----------|
| IMPORTANT..... | i |
| SUPPLIED ACCESSORIES..... | i |
| EXPLICIT DEFINITIONS..... | i |
| PRECAUTIONS..... | i |
| TRADEMARKS..... | ii |
| FCC INFORMATION..... | iii |
| 1 PANEL DESCRIPTION..... | 1 |
| Front panel..... | 1 |
| Rear panel..... | 3 |
| Microphone..... | 3 |
| Function display..... | 4 |
| 2 INSTALLATION AND CONNECTIONS..... | 5 |
| Selecting a location..... | 5 |
| Using the desktop stand..... | 5 |
| Grounding..... | 5 |
| Connecting an antenna..... | 5 |
| Connecting an external DC power supply..... | 6 |
| 3 BASIC OPERATION..... | 7 |
| When first applying power..... | 7 |
| Turning power ON or OFF..... | 7 |
| Adjusting the volume level..... | 7 |
| Selecting the mode..... | 8 |
| Using the VFO mode..... | 8 |
| Selecting the operating band..... | 8 |
| Selecting the operating mode..... | 8 |
| Setting the frequency..... | 9 |
| Dial Lock function..... | 9 |
| RF gain and SQL level..... | 10 |
| Meter display selection..... | 10 |
| Adjusting the transmit output power..... | 10 |
| Adjusting the microphone gain..... | 10 |
| 4 RECEIVING AND TRANSMITTING..... | 11 |
| Preamplifiers..... | 11 |
| Attenuator..... | 11 |
| Meter peak hold..... | 11 |
| RIT function..... | 11 |
| Noise Blanker..... | 11 |
| IF Shift function..... | 12 |
| Selecting the IF filter..... | 13 |
| Noise Reduction..... | 15 |
| Automatic Notch Filter (ANF)..... | 15 |
| Split frequency operation..... | 15 |
| Microphone Compressor..... | 16 |
| VOX function..... | 16 |
| 5 MEMORY CHANNEL AND SCAN..... | 17 |
| Memory channel operation..... | 17 |
| Scan operation..... | 17 |
| 6 SET MODE..... | 18 |
| Set mode description..... | 18 |
| Quick Set mode items..... | 19 |
| Initial Set mode items..... | 20 |
| 7 SPECIFICATIONS..... | 22 |
| 8 OPTIONS..... | 23 |
| 9 MAINTENANCE..... | 24 |
| INSTALLATION NOTES..... | 25 |
| INDEX..... | 25 |
| DÉFINITIONS EXPLICITES..... | 26 |
| PRÉCAUTIONS..... | 26 |
| INFORMATION FCC..... | 27 |

Front panel

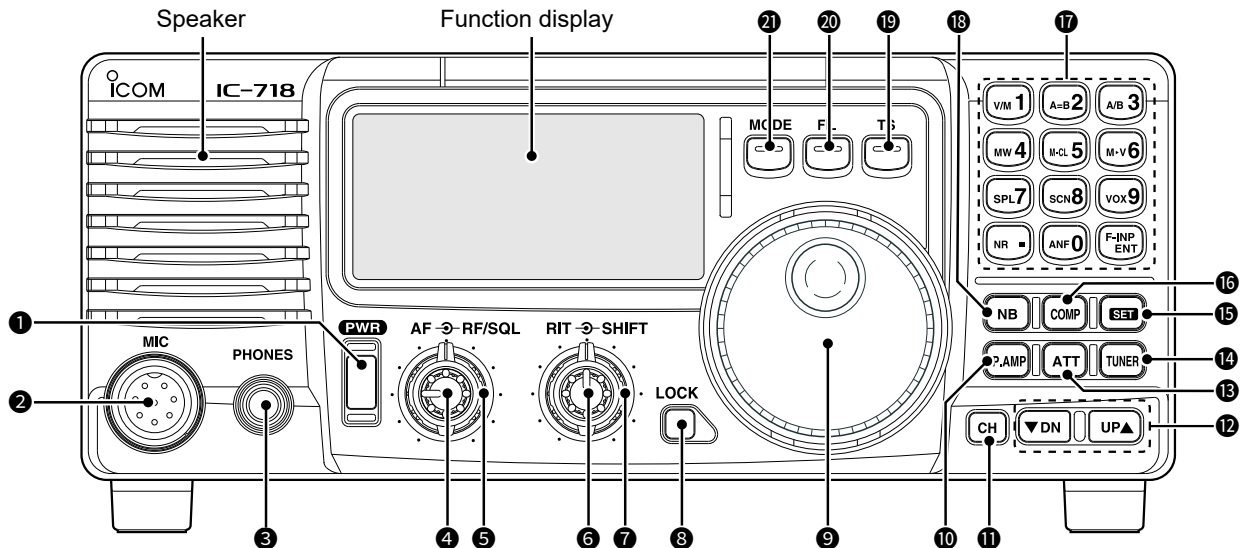

① POWER SWITCH [PWR]

- Push to turn ON the transceiver.
 - ① Confirm the external DC power supply is ON.
- Hold down for 1 second to turn OFF.
- While holding down [SET], push [PWR] to enter the Initial Set mode. (p. 18)

② MICROPHONE CONNECTOR [MIC] (p. 3)

Connect the supplied or an optional microphone.

③ HEADPHONE JACK [PHONES]

Connects to a standard stereo headphones. (8 Ω)
 ① When headphones are connected, the internal or external speaker does not function.

④ AF CONTROL [AF] (Inner control) (p. 7)

Rotate to adjust the audio output level.

⑤ RF GAIN/SQUELCH CONTROL [RF/SQ] (Outer control) (pp. 10, 20)

Rotate to adjust the squelch threshold level.

⑥ RIT CONTROLS [RIT] (Inner control) (p. 11)

Rotate to shift the receive frequency without changing the transmit frequency. Rotate clockwise to increase the frequency or counterclockwise to decrease.

⑦ IF SHIFT CONTROLS [SHIFT] (Outer control)

(p. 12)
 Rotate to shift the center frequency of the receiver's IF passband. Rotate clockwise to shift the center frequency higher or counterclockwise to shift it lower.

⑧ LOCK SWITCH [LOCK] (p. 9)

Push to turn the Dial Lock function ON or OFF.
 ① The Dial Lock function electronically locks the [MAIN DIAL].

⑨ MAIN DIAL [MAIN DIAL]

- Rotate to change the operating frequency.
- Selects an item in the Quick/Initial set mode, and so on.

⑩ PREAMP SWITCH [P.AMP] (p. 11)

Push to turn the preamp ON or OFF.

⑪ CH SWITCH [CH] (p. 17)

Push to turn the Memory Channel Select function ON or OFF.

⑫ MEMORY CHANNEL (BAND) UP/DOWN SWITCHES [▼DN]/[UP▲] (pp. 8, 17, 18)

- Push several times to select a Memory channel while "MEMO" is blinking.
- Push to select a band.
- Push to select an item in the Quick/Initial Set mode.

⑬ ATTENUATOR SWITCH [ATT] (p. 11)

Push to turn the 20 dB Attenuator function ON or OFF.

⑭ TUNER SWITCH [TUNER] (p. 20)

- Push to turn the Automatic Antenna Tuner function ON or OFF.
- Hold down for 1 second to manually start the tuner.
 - ① An optional antenna tuner must be connected.

1 PANEL DESCRIPTION

Front panel

15 SET SWITCH [SET]

- Hold down for 1 second to enter the Quick Set mode. (p. 18)
- While holding down [SET], push [PWR] to enter the Initial Set mode. (p. 18)
- Push to select the Meter function. (p. 10)

16 MIC COMPRESSOR SWITCH [COMP] (p. 16)

Toggles the Microphone Compressor function ON or OFF.

17 KEYPAD (p. 9)

Used for direct frequency input, selecting Memory channel or secondary functions.

See the table to the right for the secondary functions for each key.

18 NOISE BLANKER SWITCH [NB] (p. 11)

- Push to turn the Noise Blanker ON or OFF.
- Hold down [NB] for 1 second to enter the Noise Blanker Level Setting mode.

19 QUICK TUNING STEP SWITCH [TS] (p. 9)

- Selects a Quick Tuning step or turns OFF the Quick Tuning step.
 - While the Quick Tuning icon “▼” is displayed, Changes the operating frequency in kHz steps.
- While the Quick Tuning step is OFF, hold down for 1 second to turn the 1 Hz step ON or OFF.
- While the kHz Quick Tuning step is selected, hold down for 1 second to enter the Tuning Step Set mode.

20 FILTER SWITCH [FIL] (p. 13)

Push to select the preset normal, wide, or narrow IF filters for the selected operating mode.

21 MODE SWITCH [MODE] (p. 8)

Push to select an operating mode.

- In the SSB mode, holding down [MODE] for 1 second toggles between LSB and USB.
- In the CW mode, holding down [MODE] for 2 seconds toggles between CW and CW Reverse.
- In the RTTY mode, holding down [MODE] for 2 seconds toggles between RTTY and RTTY Reverse.

The secondary functions for the numeric keys

| No./ Secondary function | | Description |
|-------------------------------|-------|---|
| 1 | V/M | VFO/MEMORY (pp. 8, 17) Push to toggle the operating mode between the VFO mode and the Memory mode. |
| 2 | A=B | VFO EQUALIZATION (p. 8) Push to equalize the VFO B frequency and operating mode to the VFO A settings. |
| 3 | A/B | VFO SELECT (p. 8) <ul style="list-style-type: none"> • In the VFO mode, hold down for 1 second to clear the selected Memory channel content. • When the Split Frequency function is ON, push to toggle between the transmit and the receive frequency. |
| 4 | MW | MEMORY WRITE (p. 17) Hold down for 1 second to enter the current frequency and operating mode into the selected Memory channel. |
| 5 | M=CL | MEMORY CLEAR (PDF) In the Memory mode, hold down for 1 second to clear the selected Memory channel content. <ul style="list-style-type: none"> • “Blank” is displayed above the Memory channel number. |
| 6 | MV | MEMORY ► VFO (p. 17) Hold down for 1 second to copy the memory content to the VFO. |
| 7 | SPL | SPLIT (p. 15) Push to turn the Split Frequency function ON or OFF. |
| 8 | SCN | SCAN (p. 17) <ul style="list-style-type: none"> • Push to Start or stop the Programmed Scan in the VFO mode. • Push to start or stop the Memory Scan in the Memory mode. |
| 9 | VOX | VOX (p. 16) In the SSB mode, push to turn the VOX function ON or OFF. |
| 0 | ANF | AUTOMATIC NOTCH FILTER (p. 15) In the SSB and AM modes, push to turn the Automatic Notch Filter function ON or OFF. |
| . | NR | NOISE REDUCTION (p. 15) (Usable for only the USA version) <ul style="list-style-type: none"> • Push to turn the Noise Reduction function ON or OFF. This function can be used in all modes. • Hold down for 1 second to enter the Noise Reduction Level Set mode. |
| ENT | F-INP | FREQUENCY INPUT (p. 9) <ul style="list-style-type: none"> • Push to enter the Direct Frequency Input mode. • After pushing [CH], push to enter the Direct Memory Number Selection mode. |

Rear panel

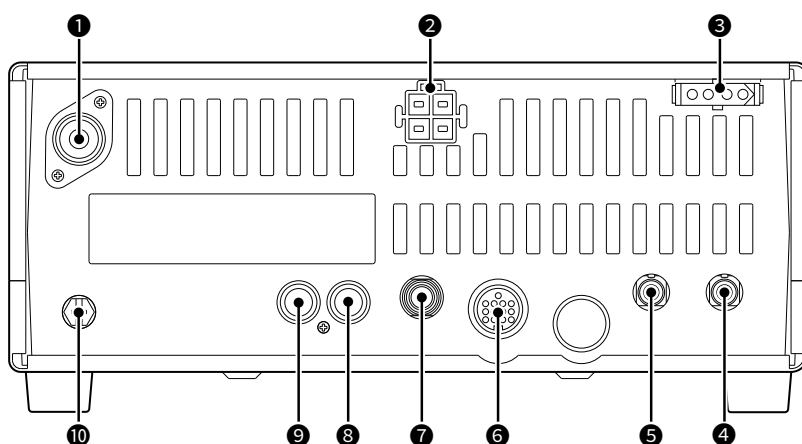

- 1 ANTENNA CONNECTOR [ANT]** (p. 5)
Connects to a 50 Ω antenna with a PL-259 PLUG CONNECTOR and a 50 Ω coaxial cable.
- 2 DC POWER SOCKET [DC 13.8V]** (p. 6)
Connects to a 13.8 V DC source through the supplied DC power cable.
- 3 TUNER CONTROL SOCKET [TUNER]** (PDF)
Connects to the control cable from an optional AH-4 AUTOMATIC ANTENNA TUNER.
- 4 CI-V REMOTE CONTROL JACK [REMOTE]** (PDF)
Connects to a PC for remote controlling the transceiver.
- 5 EXTERNAL SPEAKER JACK [EXT SP]** (PDF)
Connects to an 8 Ω external speaker.
 - When an external speaker is connected, the internal speaker is disabled.
- 6 ACCESSORY SOCKET [ACC]** (PDF)
Connects to external equipment such as a linear amplifier, an automatic antenna tuner, a TNC for data communications, and so on.
- 7 ELECTRONIC KEYS JACK [KEY]** (p. 20)
Accepts a key or paddle connector for the internal electronic keyer.
 - You can select the keyer type between the internal electronic keyer and straight key operation in the Initial Set mode.
- 8 ALC INPUT JACK [ALC]**
Connects to the ALC output jack of a non-Icom linear amplifier.
- 9 SEND CONTROL JACK [SEND]**
Goes to ground while transmitting to control external equipment such as a liner amplifier.
 - Maximum control level: 16 V DC/2 A

- 10 GROUND TERMINAL [GND]** (p. 5)
Connects to ground to prevent electrical shock, TVI, BCI and other problems.

Microphone

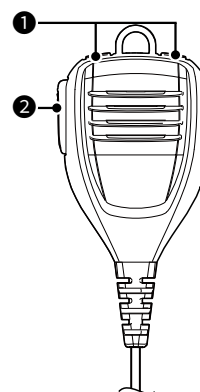

- 1 UP/DOWN SWITCHES [UP]/[DN]**
 - Push to change the operating frequency or Memory channel.
 - Holding down to continuously change the frequency or Memory channel.
 - ① The [UP]/[DN] keys can simulate a key paddle. Set the Key Type (CW PADDLE) item in the Initial Set mode. (p. 20)
- 2 PTT SWITCH**
Push to transmit, release to receive.

NOTE: To maximize the readability of your signal, hold the microphone 5 to 10 cm (2 to 4 inches) from your mouth, and then speak at your normal voice level.

Function display

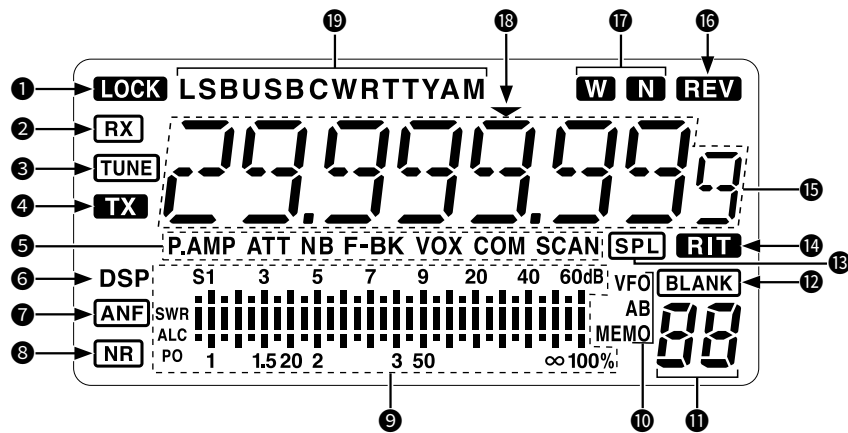

1 LOCK ICON **LOCK** (p. 9)

Displayed when the Dial Lock function is ON.

2 RECEIVE ICON **RX** (p. 7)

Displayed while receiving a signal or when the squelch is open.

3 TUNE ICON **TUNE**

Displayed when the Automatic Tuning function is ON.

4 TRANSMIT ICON **TX**

Displayed while transmitting.

5 FUNCTION ICONS

| Icon | Status |
|--------------|---|
| P.AMP | The antenna preamplifier is ON. |
| ATT | The Attenuator function is ON. |
| NB | The Noise Blanker function is ON. |
| BK | The Semi Break-in function is ON. |
| F-BK | The Full Break-in function is selected in the CW mode. |
| VOX | The VOX function is ON. |
| COM | The Microphone Compressor function is ON in the SSB mode. |
| SCAN | <ul style="list-style-type: none"> The Scan function is ON. Blinks when a Scan is paused. |

6 DSP UNIT ICON “DSP”

Displayed only on the USA version.

7 AUTOMATIC NOTCH FILTER ICON **ANF** (p. 15)

(For only the USA version, displayed when the Automatic Notch Filter function is ON.

8 NOISE REDUCTION ICON **NR** (p. 15)

For only the USA version, displayed when the Noise Reduction function is ON.

9 SIGNAL/SQL/RF-GAIN METER

- Displays the signal strength while receiving.
- Displays the relative output power, ALC, or SWR levels while transmitting. (p. 10)

10 VFO/MEMORY ICON (p. 8)

“VFO A” or “VFO B” is displayed when the VFO mode is selected.
“MEMO” is displayed when the Memory mode is selected.

11 MEMORY CHANNEL NUMBER READOUT (p. 17)

Displays the selected Memory channel number.

12 BLANK ICON **BLANK** (p. 17)

In the VFO and Memory modes, indicates that the selected Memory channel has no content.

13 SPLIT ICON **SPL** (p. 15)

Displayed when the Split function is ON.

14 RIT ICON **RIT** (p. 11)

Displayed when the RIT function is in use.

15 FREQUENCY READOUT

Displays the operating frequency.

16 REVERSE ICON **REV** (p. 8)

Displayed when the CW Reverse or RTTY Reverse mode is selected.

17 WIDE/NARROW FILTER ICONS (p. 13)

- **W** : Displayed when the wide IF filter is selected.
- **N** : Displayed when the narrow IF filter is selected.

18 QUICK TUNING STEP ICON

Displayed when you select the Quick Tuning step.

19 MODE ICONS (p. 8)

Displays the selected operating mode.

Selecting a location

Select a location for the transceiver that allows adequate air circulation, free from extreme heat, cold, or vibration, and other electromagnetic sources.

Never place the transceiver in areas such as:

- Out of the specified temperature range ($-10^{\circ}\text{C} \sim +60^{\circ}\text{C}$, $+14^{\circ}\text{F} \sim +140^{\circ}\text{F}$).
- An unstable place that slopes or vibrates.
- In direct sunlight.
- High humidity and temperature environments.
- Dusty environments.
- Noisy environments.

Using the desktop stand

The transceiver has a stand for desktop use.

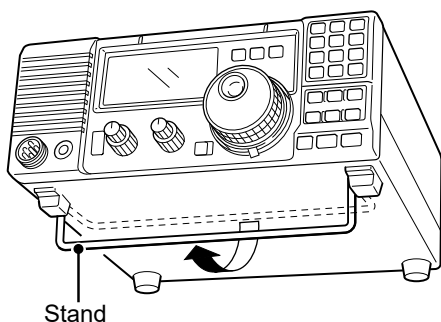

NOTE: DO NOT hold the stand, dials, or controls when you carry the transceiver. This may damage them.

Grounding

To prevent electrical shock, television interference (TVI), broadcast interference (BCI) and other problems, ground the transceiver through the GROUND terminal [GND] on the rear panel.

For best results, connect a heavy gauge wire or strap to a long ground rod. Make the distance between the [GND] terminal and ground as short as possible.

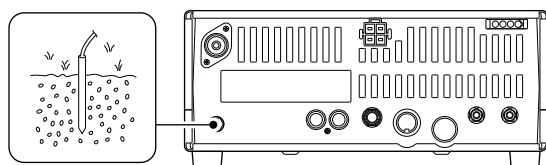

⚠ WARNING! NEVER connect the [GND] terminal to a gas or electric pipe, since the connection could cause an explosion or electric shock.

Connecting an antenna

For radio communications, the antenna is of critical importance, along with output power and receiver sensitivity.

Select antenna(s), such as a well-matched $50\ \Omega$ antenna, and feedline. A Voltage Standing Wave Ratio (VSWR) of 1.5:1 or less is recommended for your desired band.

NOTE: A lightning arrestor may offer some protection from static electricity.

Antenna

Example: For 1.8 to 30 MHz bands

AH-710

Approximately
24.5 m, 80.3 ft

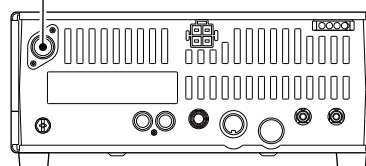
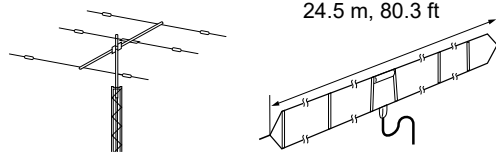

Antenna SWR

Each antenna is tuned for a specified frequency range and SWR may increase out of that range. When the SWR is higher than approximately 2.0:1, the transceiver's power drops to protect the final transistor.

In this case, an antenna tuner is helpful to match the transceiver and antenna. The IC-718 has an SWR meter to continuously monitor the antenna SWR.

Connecting an external DC power supply

Confirm that the transceiver is OFF before connecting the DC power cable.

① When connecting a non-Icom DC power cable, the transceiver needs:

- DC 13.8 V (Capacity: At least 18 Amps)
- A power supply with an over current protective line, and low voltage fluctuation or ripple.

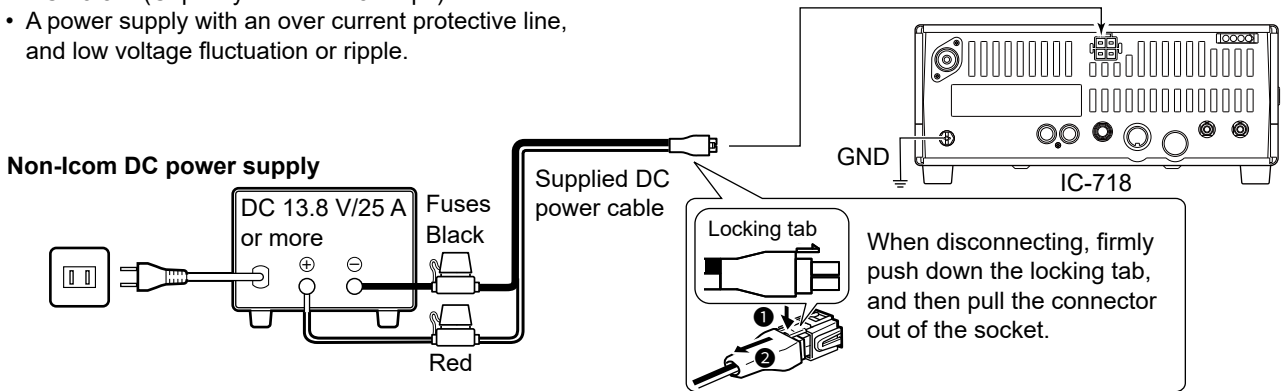

Fuse replacement

A fuse is installed in each fuse holder of the supplied DC power cable, to protect the transceiver. If the transceiver does not turn ON because a fuse blows, find and repair the cause of the problem. Then replace any blown fuse with a new, adequately rated fuse. (ATQ 25A)

① Spare fuses are supplied with the transceiver.

⚠ WARNING!

- Disconnect the DC power cable from the external power source before replacing the fuse.
- **NEVER** use fuses other than specified ones.

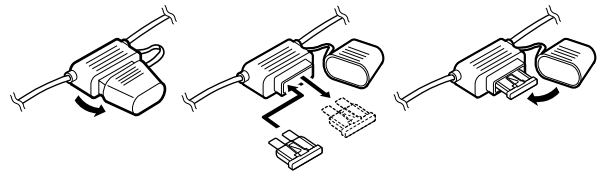

◇ When connecting to a vehicle's battery

⚠ **WARNING! NEVER** connect to a battery without using a DC fuse, otherwise a fire hazard could occur or damage to the transceiver.

- **NEVER** connect the transceiver to a 24 V battery.

NOTE:

- **DO NOT** use a cigarette lighter socket as a power source when operating in a vehicle. The plug may cause voltage drops and ignition noise may be superimposed onto transmit or receive audio.
- The transceiver may not receive well on some frequencies when installed in a hybrid vehicle, or any type of electric vehicle (fuel cell vehicle). This is because vehicle's electric components, such as the inverter system, generate a lot of electrical noise.

- Use a rubber grommet when passing the DC power cable through a metal plate to prevent a short circuit.

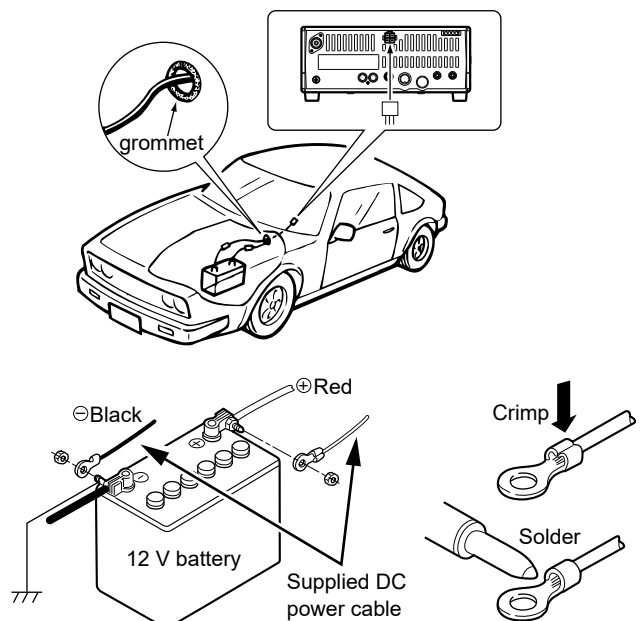

When first applying power

Before turning ON your transceiver for the first time, make sure all connections are correctly made.

TIP: When you turn OFF the transceiver, it memorizes the current settings. Therefore, when you turn ON the transceiver again, it restarts with the same settings.

◇ Resetting the settings

A resetting **CLEARs** all Memory channel programming and returns all Quick Set mode and Initial Set mode settings to their factory defaults.

1. Make sure the transceiver power is OFF.
2. While holding down [UP▲] and [▼DN], hold down [PWR] for 1 second to turn ON the transceiver.
 - The internal CPU is reset.
 - The transceiver displays its initial VFO frequencies when reset has been completed.
3. All the Quick Set mode and the Initial Set mode settings return to their default values. (p. 18)

NOTE: In cooler temperatures, the display may be dark and unstable after turning ON the transceiver. This is normal and does not indicate any equipment malfunction.

◇ Initializing the controls and switches

After resetting the transceiver, set the controls and switches as shown below:

- [METER]: Po
- [PWR]: OFF
- [AF]: Maximum counter clockwise
- [RF/SQL]: 12 o'clock
- [RIT]: Center
- [IF SHIFT]: Center
- [LOCK]: OFF
- [NB]: OFF
- [COMP]: OFF
- [P.AMP]: OFF
- [ATT]: OFF

Turn ON the transceiver, and then check the display. If any of the following icons is displayed, turn them OFF by operating as follows:

- Quick tuning step icon (▼): Push [TS].
- 1 Hz frequency readout: Hold down [TS] for 1 second. (When the Quick Tuning step is OFF.)
- RIT icon (**RIT**): Set the [RIT] control to the center position.
- Split icon (**SPL**): Push [SPL].

Turning power ON or OFF

- Push [PWR] to turn ON the transceiver.
- Hold down [PWR] for 1 second to turn OFF the transceiver.

Adjusting the volume level

Rotate [AF] to adjust the volume level.

Selecting the mode

VFO mode

Set the desired frequency by rotating [MAIN DIAL], directly entering with keypad, or reading from a Memory channel with the Memory Copy function.

Memory mode

Enter contents into the desired channel in the Memory list.

Selecting the VFO mode or Memory mode

Push [V/M] to select VFO or Memory mode.

- “VFO A” or “VFO B” is displayed in the VFO mode, or “MEMO” and current Memory channel number is displayed in the Memory mode.

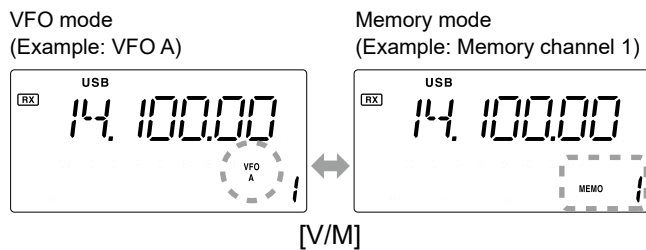

Using the VFO mode

The IC-718 has 2 Variable Frequency Oscillators (VFO), “A” and “B.” Having 2 VFOs is convenient to quickly toggle between 2 frequencies, or for split frequency operation (p. 15). You can use either of the VFOs to operate on a frequency and mode.

◇ Selecting VFO A or VFO B

In the VFO mode, push [A/B] to toggle between VFO A and B.

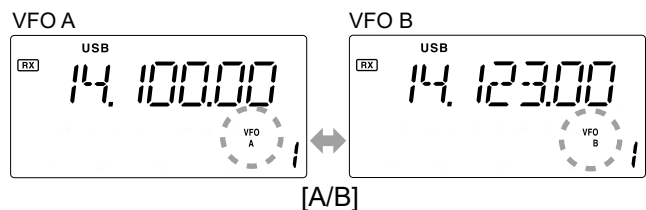

◇ Equalizing VFO A and VFO B

You can set the displayed VFO’s frequency to the other VFO.

Push [A=B] to equalize the VFO A and VFO B frequency and mode.

Selecting the operating band

All HF ham bands and a general coverage receiver band are usable on the IC-718.

Push [UP ▲] or [▼DN] several times to select an operating band.

Selecting the operating mode

You can select an operating mode from the SSB (LSB/USB), CW, CW reverse, RTTY, RTTY reverse, and AM modes.

1. Push [MODE] several times to select a mode.
2. In the selected mode, hold down [MODE] for 1 second to toggle the operating mode.

Operating mode selection list

| Mode (Push [MODE]) | Operating mode (Hold down [MODE] for 1 second) | |
|-----------------------|---|---------------------------|
| SSB | USB | LSB |
| CW | CW | CW REV (reverse) |
| RTTY | RTTY | RTTY REV (reverse) |
| AM | AM | |

① You can inhibit some modes from the selection, if you do not usually operate them. (p. 20)

TIP: About the Band Stacking Register

The Band Stacking Register automatically stores the previously operated frequency and mode for each band.

See the table below about the usable bands and the default setting of each register.

| BAND | FREQUENCY | MODE |
|---------|--------------|------|
| 1.9 MHz | 1.91000 MHz | CW |
| 3.5 MHz | 3.55000 MHz | LSB |
| 7 MHz | 7.05000 MHz | LSB |
| 10 MHz | 10.12000 MHz | CW |
| 14 MHz | 14.10000 MHz | USB |
| General | 15.10000 MHz | USB |
| 18 MHz | 18.10000 MHz | USB |
| 21 MHz | 21.20000 MHz | USB |
| 24 MHz | 24.95000 MHz | USB |
| 28 MHz | 28.50000 MHz | USB |
| 29 MHz | 29.50000 MHz | USB |

① The General coverage frequency is automatically positioned, according to the previously operated frequency.

Setting the frequency

◇ Using the Main Dial

1. Select the desired operating band and operating mode.
2. Rotate [MAIN DIAL].
 - The frequency changes according to the selected Tuning Step.

For General coverage receiver use

The transceiver has a general coverage receiver band.

- Push [UP▲] or [▼DN] to select the general coverage receiver band.

Band Edge Beep

Even if you select a ham band, you can select a General coverage frequency. A band edge beep sounds when entering and exiting a ham band, depending on the Band edge beep setting. (p. 20)

- ① You can change the Band Edge Beep settings in the Initial Set mode.
- ① If "Beep Level" is set to "1," no beep sounds.

◇ Entering with the keypad

You can directly enter a desired frequency with the numeric keypad.

1. Push [F-IMP/ENT].
 - the decimal points on the screen blink.
2. Enter an operating frequency.
 - ① Push [•] to enter decimal point between the MHz and kHz digits.
 - ① To cancel the input, push [SET] or a key other than the keypad keys.
 - ① You can omit the MHz digits entry if you do not need to change it.
3. Push [F-IMP/ENT] to set the entered frequency.

Entry examples

- 21.025 MHz:
[2], [1], [•], [0], [2], [5], [F-IMP/ENT]
- 706 KHz (0.706 MHz):
[0], [•], [7], [0], [6], [F-IMP/ENT]
- 7 MHz:
[7], [F-IMP/ENT]
- Changing from 14.195 MHz to 14.850 MHz:
[•], [8], [5], [0], [F-IMP/ENT]

Dial Lock function

The Dial Lock function prevents frequency changes caused by accidentally moving [MAIN DIAL].

- ① This function electronically locks the dial.

Push [LOCK] for 1 second to turn the Dial Lock function ON or OFF.

◇ Quick Tuning Step

When the Quick Tuning function is ON, you can change the tuning step to 0.1, 1, 5, 9, 10, or 100 kHz.

1. Push [TS] to turn ON the Quick Tuning function.
 - "▼" is displayed,

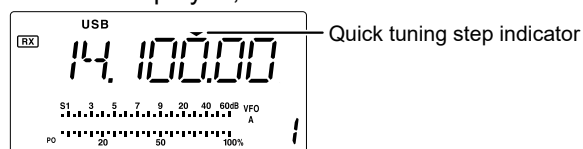

2. Hold down [TS] for 2 seconds to enter the Tuning Step Set mode.
3. Rotate [MAIN DIAL] to select a tuning step.

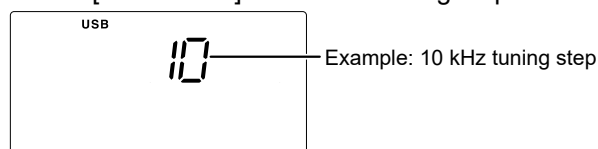

- ① Options: 0.1, 1, 5, 9, 10, or 100 kHz

4. Push [TS] to exit the mode.
5. Rotate [MAIN DIAL] to change the frequency by the set tuning steps.
6. Push [TS] to turn OFF the Quick tuning function.
 - "▼" disappears.

◇ About the 1 Hz step Fine Tuning function

You can use the minimum tuning step of 1 Hz for fine tuning.

1. Confirm that the Quick Tuning function is OFF ("▼" is not displayed.)
2. Hold down [TS] for 1 second to toggle the tuning step between 1 Hz and 10 Hz.
 - When the tuning step is set to 1 Hz, the 1 Hz digit is displayed.



- Rotating [MAIN DIAL] increases or decreases the frequency by the set tuning steps.

◇ About the Auto Tuning Step function

The tuning step automatically changes, depending on the rotation speed of [MAIN DIAL].

- ① You can change the Auto Tuning Step function settings in the Initial Set mode. (p. 20)

RF gain and SQL level

The transceiver uses the same control [RF/SQL] to adjust either the RF gain and the squelch. By default, when the control is set to the 12 o'clock position, rotating the control counterclockwise adjusts the RF gain, and clockwise adjusts the squelch level as shown below.

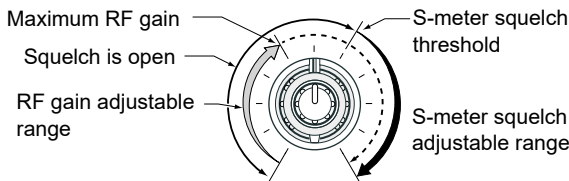

① The function of the [RF/SQL] control can be customized in the Initial Set mode. (p. 20)

◇ RF gain

You can adjust the receive sensitivity.

If a strong interfering signal is received, rotate [RF/SQL] counterclockwise to reduce the RF gain.

NOTE: We recommend setting the RF Gain control to the 12 o'clock position since this sets RF gain to the maximum.

◇ Squelch (SQL) level

The S-meter squelch mutes the audio output from the speaker or headphones when the received signal is weaker than the specified S-meter squelch level. Rotate the [RF/SQL] clockwise from the 12 o'clock position to increase the S-meter threshold level.

① The meter segments display the S-meter squelch level.

Meter display selection

You can display one of the transmit parameters (Po, ALC, and SWR) for your convenience.

Push [SET] several times to select one of the meters.

Meter functions

(none): Displays the receiving signal strength level.

Po: Displays the relative RF output power.

ALC: Displays the ALC level. When the meter movement shows the input signal level exceeds the allowed level, the ALC limits the RF power. In such cases, decrease the microphone gain level.

SWR: Displays the SWR of the antenna at the displayed frequency.

Adjusting the transmit output power

Before transmitting, monitor your selected operating frequency to make sure you do not cause interference to other stations on the same frequency.

1. Hold down [SET] for 1 second.
 - Enters the Quick Set mode.
2. Push [UP▲]/[▼DN] to select "RF Power."
3. Rotate [MAIN DIAL] to set the output power to between L (Low), 1 ~ 99, and H (High).

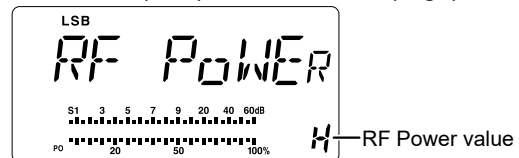

4. PUSH [SET] to exit the Quick Set mode.

The usable power

SSB/CW/RTTY: 2 (or less) ~ 100 W

AM: 2 (or less) ~ 35 W (Career power)

Adjusting the microphone gain

Properly adjust the microphone gain to prevent distort your transmitted signal.

1. Set the operating band and mode to SSB or AM.
2. Hold down [SET] for 1 second.
 - Enters the Quick Set mode.
3. Push [UP▲]/[▼DN] to select "MIC GAIN."
4. Hold down [PTT] and adjust the microphone gain.

① Information

- Hold the microphone 5 to 10 cm (2 to 4 inches) from your mouth, then hold down [PTT] on the microphone and speak at your normal voice level.
- In the SSB mode, set the meter to the ALC meter, and rotate [MAIN DIAL] to adjust the microphone gain until the meter reading does not peak past the ALC zone.

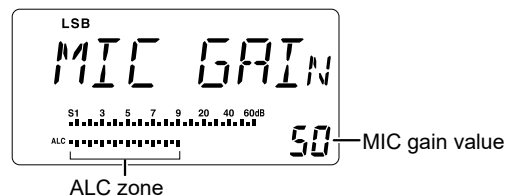

- In the AM mode, check the audio clarity with another station.
5. Release [PTT].
 6. Push [SET] to exit the Quick Set mode.

Preamplifiers

Below the 1.59999 MHz bands

The preamp amplifies received signals in the receiver front end to improve the signal-to-noise (S/N) ratio and sensitivity. A preamp is used when receiving weak signals.

The preamplifier functions below the 1.59999 MHz bands, however, the sensitivity may be reduced.

① Each band memorizes the Preamplifier setting.

1. Select the operating band.
2. Push [P.AMP] to turn the preamplifier ON or OFF.
 - "P.AMP" is displayed when the function is ON.

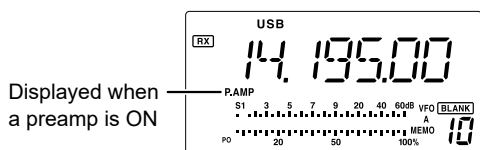

NOTE: When you use the preamp while receiving strong signals, the receiving signal may be distorted. In such case, turn OFF the preamp.

Attenuator

The Attenuator prevents a desired signal from becoming distorted when a very strong signal is near the frequency, or when a very strong electric field, such as from a broadcasting station, is near your location.

① Each band memorizes the Attenuator setting.

1. Select the operating band.
2. Push [ATT] to turn the 20 dB attenuator ON or OFF.
 - "ATT" is displayed when the function is ON.

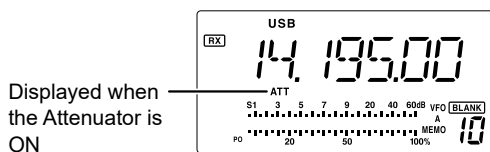

Meter peak hold

The meter peak hold function keeps the highest displayed bar segment in any meter function for about 0.5 seconds so that you can read the meter indication easier.

This function can be turned ON or OFF in the Initial Set mode.

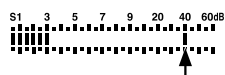

The peak meter remains for 0.5 seconds

RIT function

The Receiver Incremental Tuning (RIT) function compensates for differences in frequencies of other stations.

The function shifts your receive frequency up to ± 1.2 kHz without shifting the transmit frequency.

1. Rotate the [RIT] control to set the RIT frequency to match the received station's transmit frequency.
 - "RIT" is displayed while RIT frequency is set.
 - The transmit frequency on the screen does not change.
2. To cancel the RIT function, rotate [RIT] to the 12 o'clock position.
 - "RIT" disappears.

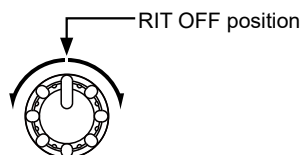

Noise Blanker

The Noise Blanker eliminates pulse-type noise, such as the noise from car ignitions.

Push [NB] to turn the Noise Blanker ON or OFF.

- "NB" is displayed while the Noise Blanker function is ON.

Adjusting the Noise Blanker level

1. Hold down [NB] for 1 second to enter the Noise Blanker level set mode.
2. Rotate [MAIN DIAL] to adjust the Noise Blanker level.
3. Push [NB] to exit the set mode.

NOTE:

- When using the Noise Blanker, received signals may be distorted if they are excessively strong, or the noise is other than a pulse type. In that case, turn OFF the Noise Blanker.
- You can turn the Noise Blanker function in the AM mode ON or OFF in the Initial set mode. (p. 20)

NB is OFF

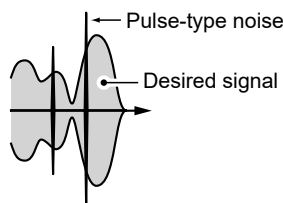

NB is ON (Effective)

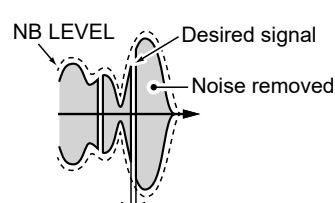

IF Shift function

The IF Shift function electronically narrows the passband frequency of the intermediate frequency (IF) and cuts out higher or lower frequency components of the IF to reject interference.

The function shifts the IF frequency up to ± 1.2 kHz in the SSB/CW/RTTY modes and up to ± 250 Hz in the CW-narrow/RTTY narrow modes.

The IF shift is not selectable in the AM mode.

IF shift operation example:

- Adjust the [SHIFT] control for minimum interference.
- When IF shift is used, the audio tone may change.
- Set the IF shift control to the center position when there is no interference.

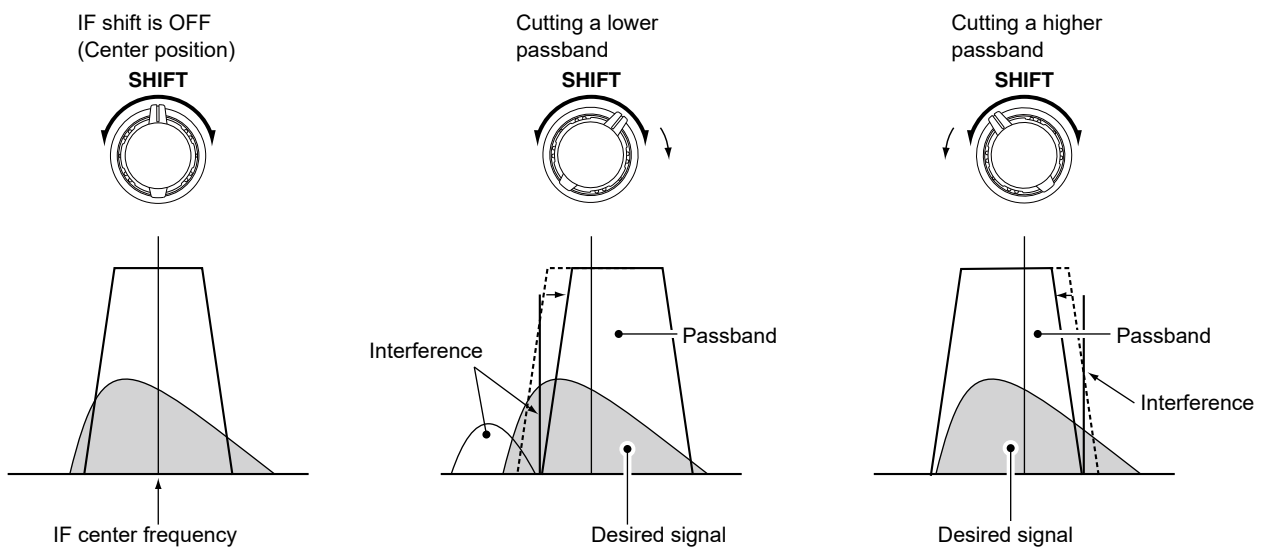

Selecting the IF filter

The filter selection adjusts the IF bandpass width, as shown to the right.

① Each operating mode memorizes the IF filter setting.

- Select the desired mode with the mode keys.
- Push [FIL] several times to select the desired filter combination.
 - W** or **N** is not displayed when using the Normal (standard) IF filter.
 - W** is displayed when the Wide IF filter is selected.
 - N** is displayed when the Narrow IF filter is selected.

| Filter | | Band width | Mode |
|----------|-----|--------------|-----------------------------------|
| Standard | | 6 kHz | SSB/CW/RTTY: Wide AM: Normal |
| | | 2.4 kHz | SSB/CW/RTTY: Normal AM: Narrow |
| Optional | 52A | 500 Hz/−6dB | CW/RTTY: Narrow |
| | 53A | 250 Hz/−6dB | CW/RTTY: Narrow |
| | 96 | 2.8 kHz/−6dB | SSB: Wide |
| | 222 | 1.8 kHz/−6dB | SSB: Narrow |
| | 257 | 3.3 kHz/−6dB | SSB: Wide |

Filter image

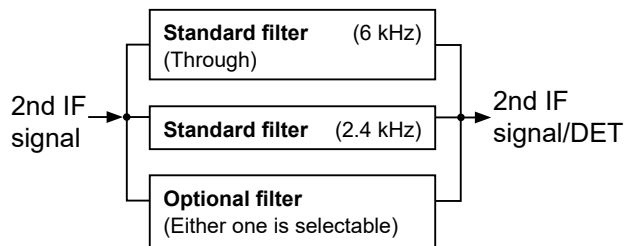

Filter selection table

(Unit: Hz)

| Mode | Filter width | Expanded filter | Optional filter | | | | | |
|------------|--------------|-----------------|-----------------|-----|-----|-------|-------|-------|
| | | | None | 52A | 53A | 96 | 222 | 257 |
| SSB | WIDE | OFF | – | | | 2.8 k | – | 3.3 k |
| | | ON | 6 k | | | | | |
| | NORMAL | OFF/ON | 2.4 k | | | | | |
| | | OFF | – | | | – | 1.8 k | – |
| CW RTTY | WIDE | OFF | – | | | 2.8 k | – | 3.3 k |
| | | ON | 6 k | | | | | |
| | NORMAL | OFF/ON | 2.4 k | | | | | |
| | | OFF/ON | – | 500 | 250 | – | 1.8 k | – |
| AM | WIDE | OFF/ON | – | | | | | |
| | | OFF/ON | 6 k | | | | | |
| | NARROW | OFF | 2.4 k | | | | | |
| | | ON | 2.4 k | 500 | 250 | 2.8 k | 1.8 k | 3.3 k |

- ① To use the filters marked with , you must set the short-pin on the main board. Refer to the next page and set the short-pin to the position according to your desired filter width.

4 RECEIVING AND TRANSMITTING

Selecting the IF filter

Choose the appropriate filter for your operating needs. To use an Optional filter, you need the following steps:

- Set an IF bandpass width by replacing the short-pin on the main board.
- Select the proper filter in the Initial Set mode.

◇ Setting the short-pin

1. Remove the transceiver's bottom cover.

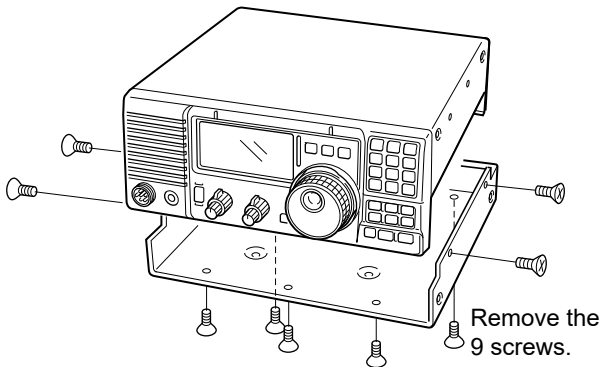

2. Remove the short-pin as shown below, and install it onto the appropriate pins, according to your desired bandpass width.

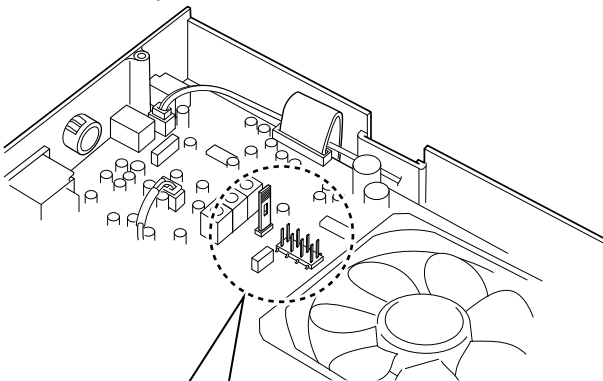

Remove and replace the short-pin to the desired bandpass width.

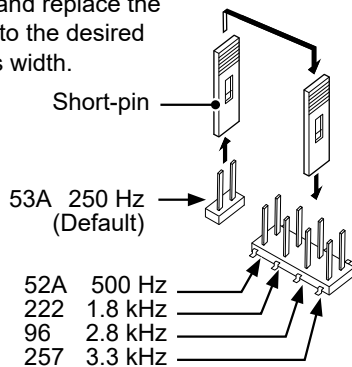

3. Replace the bottom cover and the screws to their original positions.

After installing the short-pin, select the filter in the Initial Set mode. Otherwise, the set filter will not function properly.

CAUTION: DISCONNECT the DC power cable before performing any work inside the transceiver to prevent an electrical shock or damage to the transceiver.

◇ Setting the filter

The optional filter is not selected by default.

To use an Optional filter, set the items in the Initial Set mode.

Entering the Initial Set mode

1. Turn OFF the transceiver.
2. While holding down [SET], push [PWR].
 - Enters the Initial set mode.
3. When the setting has been finished, push [PWR] to exit the Initial Set mode and turn OFF the transceiver.

Selecting an Optional filter

1. In the Initial Set mode, push [UP▲] or [▼DN] to select "FIL."
2. Rotate [MAIN DIAL] to select a desired filter from no (None,) 52A, 53A, 96, 222, and 257.

Selecting an Expanded filter

1. In the Initial Set mode, push [UP▲] or [▼DN] to select "EXP FIL."
2. Rotate [MAIN DIAL] to set the Expanded filter ON or OFF.
 - ① You can use the expanded filter when this item is set to ON.
 - ① See the filter selection table on the previous page for details.

• Selecting the Wide or Narrow filter

3. In the Initial Set mode, push [UP▲] or [▼DN] to select "WIDE" (Wide) or "NARW" (Narrow).
4. Push [MODE] to select an operating mode.
5. Rotate [MAIN DIAL] to select a filter.
 - For the Wide filter, "THU" (Through) selects the 6 kHz standard filter.
 - For the Narrow filter in the AM mode, "NOR" (Normal) selects the 2.4 kHz standard filter.
6. Repeat steps 4 and 5 to select IF filters in other operating modes, if desired.
 - ① The filter selection is memorized in each operating mode.
7. When the setting has been finished, push [PWR] to exit the Initial Set mode and turn OFF the transceiver.

Noise Reduction

(This function is only for the USA version transceiver.)

The Noise Reduction function reduces random noise components and enhances signal audio.

Push [NR] to turn the Noise Reduction function ON or OFF.

- [NR] is displayed when the function is ON.

◇ Adjusting the Noise Reduction level

Adjust the Noise Reduction level to where noise is reduced but the received signal is not distorted.

1. Hold down [NR] for 1 second.
 - Enters the Noise Reduction level set mode.

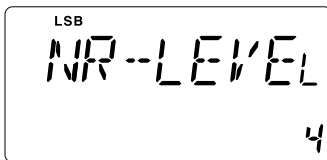

2. Rotate [MAIN DIAL] to adjust the Noise Reduction level.
 - ① Adjust to a higher level to increase the reduction level, and a lower level to decrease it.
3. Push [NR] to exit the level set mode.

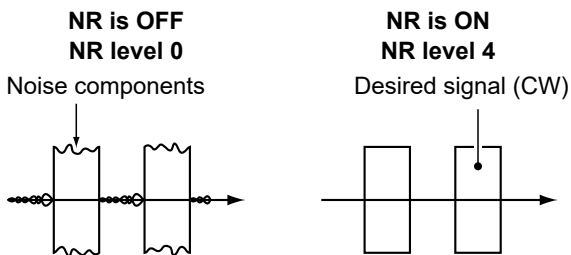

Automatic Notch Filter (ANF)

(This function is only for the USA version transceiver.)

SSB mode

Auto Notch automatically attenuates more than 3 beat tones, tuning signals, and so on, even if they are moving.

1. Select the SSB mode.
2. Push [ANF] to turn the Automatic Notch Filter function ON or OFF.
 - "ANF" is displayed when the function is ON.

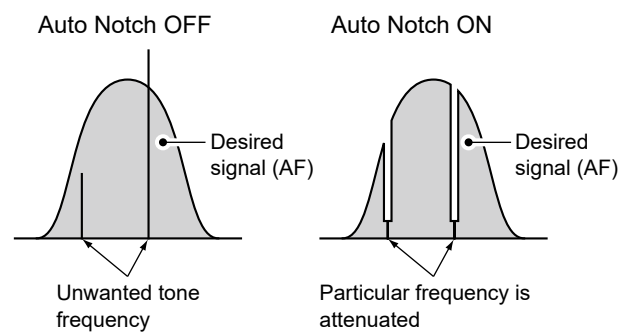

Split frequency operation

Split frequency operation enables you to transmit and receive on different frequencies in the same band.

Use the receive and transmit frequencies set to VFO A and VFO B.

1. Select VFO B, and then set the receive frequency and the operating mode. (Example: 7.025 MHz in the CW mode)
2. Push [A/B] to select VFO A.
3. Set VFO A's receive frequency and operating mode. (Example: 7.057 MHz in the CW mode)
4. Push [SPL] to turn ON the Split function.

Receive frequency

Displayed when the Split frequency is ON.

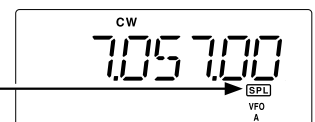

Transmit frequency

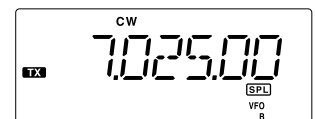

- ① Rotate [MAIN DIAL] while receiving to change the receiving frequency, and while transmitting to change the transmit frequency.
- ① Push [A/B] to toggle the transmit and receive frequencies.
5. Push [SPL] to turn the Split function OFF.

Microphone Compressor

SSB mode

The Speech Compressor increases the average RF output power, improving readability at the receiving station. This function compresses the transmitter audio input to increase the average audio output level.

- ① The function is effective for long-distance communication, or when propagation conditions are poor.

Setting before using the Microphone Compressor function

1. Select the SSB mode. (Example: USB)
2. Push [SET].
 - Enters the Quick Set mode.
3. Push [UP▲] or [▼DN] to select "MIC GAIN."
4. Adjust the microphone gain by rotating [MAIN DIAL].
 - ① Be sure the microphone gain is in the range of 20 to 50.
5. Push [SET] to exit the Quick Set mode.

Using the Microphone Compressor function

1. Push [COMP] to turn ON the microphone compressor.

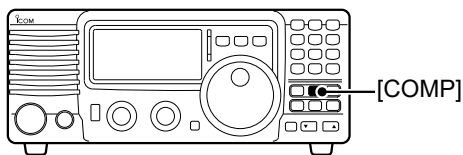

- ① "COM" is displayed while the function is ON.
2. Push [SET] until the ALC meter is displayed.
 - ① Pushing [SET] toggles the meter to Po, SWR, ALC.
 3. While speaking into the microphone at your normal voice level, rotate [MAIN DIAL] to adjust the Speech Compressor level to where the ALC meter reads within the ALC zone.

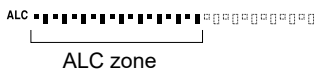

- ① If the ALC meter peaks exceed the ALC zone, your transmitted voice may be distorted.

VOX function

The Voice-operated Transmission (VOX) function switches between transmit and receive with your voice. This function enables hands-free operation.

Push [VOX] to turn the VOX function ON or OFF.

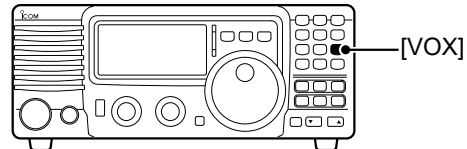

- "VOX" is displayed while the VOX function is ON.

◇ Adjusting the VOX function

Before using the VOX function, adjust the following items in the Quick Set mode.

- VOX Gain (p. 19)
- VOX Delay (p. 19)
- Anti VOX Level (p. 19)

1. Push [VOX] to turn the VOX function ON.
2. Push [SET] to enter the Quick Set mode.
3. Push [UP▲] or [▼DN] to select "VOX GAIN."
4. While speaking at your normal voice level, rotate [MAIN DIAL] to adjust the VOX gain until the transceiver transmits.
5. Push [UP▲] or [▼DN] to select "VOX Delay."
6. While speaking at your normal voice level, rotate [MAIN DIAL] to adjust the VOX delay to between 0 and 2 seconds.
7. Push [UP▲] or [▼DN] to select "Anti VOX" (AN-VOX.)
8. Adjust the Anti VOX level to prevent unwanted VOX activation from the speaker or other sounds.
9. Push [SET] to exit the Quick Set mode.

Memory channel operation

The transceiver has 101 Memory channels, 99 of regular memory channels and P1 and P2 for the Programmed Scan edge.

The Memory mode is useful for quickly changing to often-used frequencies. The entered frequency can be temporarily tuned by rotating [MAIN DIAL].

◇ Writing a Memory channel

- In the VFO mode, set the operating mode, frequency.
 - ① Preamp setting, attenuator ON or OFF, and AGC settings can also be entered into a Memory channel.
- Push [CH], and then [UP▲] or [▼DN] to select a Memory channel number you want to set.
 - “MEMO” blinks.
 - “BLANK” is displayed if the channel is blank.
- Hold down [MW] for 1 second to write the current operating mode and frequency into the Memory channel.
 - 3 beeps sound
- Push [CH] to exit the Memory Channel Select mode.

◇ Selecting a Memory channel

- Push [V/M] to select the Memory mode.
 - “MEMO” and a Memory channel number is displayed.
- Push [CH] to enter the Memory Channel Select mode.
 - “MEMO” blinks.
- Select a Memory channel by:
 - Pushing [UP▲] or [▼DN].
 - ① Hold down the key to scroll up or down.
 - Entering the channel number with the keypad.
- Push [CH] to exit the Memory Channel Select mode.

◇ Transferring a Memory channel to the VFO

You can transfer the Memory channel content to the VFO mode.

- Push [V/M] to select the VFO mode.
- Push [CH] to enter the Memory Channel Select mode.
 - “MEMO” blinks.
- Select a Memory channel by:
 - Pushing [UP▲] or [▼DN].
 - ① Hold down the key to scroll up or down.
 - Entering the channel number with the keypad.
- Hold down [M▶V] for 1 second to transfer the settings.
 - The transferred operating mode and frequency is displayed.
- Push [CH] to exit the Memory Channel Select mode.

Scan operation

◇ Programmed scan

Repeatedly scans between two scan edge frequencies.

Enter scan edge frequencies into the P1 and P2 memory channels.

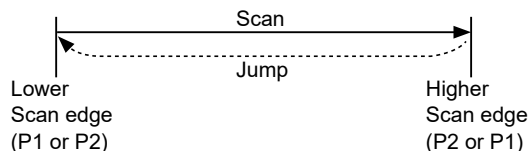

- Push [V/M] to select the VFO mode.
- Push [SCN] to start or stop the Programmed scan.
 - The scan continues until it is manually stopped.

◇ Memory scan

Repeatedly scans all entered Memory channels (except P1 and P2).

Enter two or more Memory channels to use the Memory scan.

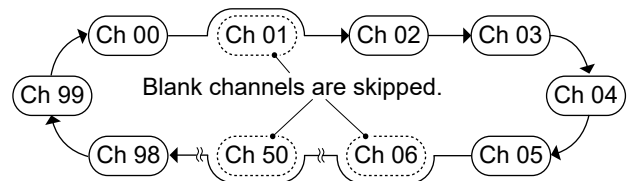

① Blank (not entered) Memory channels are skipped.

- Push [V/M] to select the Memory mode.
- Push [SCN] to start or stop the Memory scan.

◇ Squelch condition

When the scan starts with the squelch open:

- In the VFO mode, the scan continues until it is manually stopped—it does not pause, even if signals are detected.
- In the Memory mode, the scan pauses on each step when the Scan Resume function is ON. It does not pause when the function is OFF.

When the scan starts with the squelch closed:

- The scan stops when a signal is detected.
- When the Scan Resume function is ON, the scan pauses for 10 seconds after detecting a signal, then resumes 2 seconds after the signal disappears.

Set mode description

You can use the Set mode to set infrequently changed values or function settings. The transceiver has 2 set modes, the Quick Set mode and the Initial Set mode.

◇ Quick Set mode operation

1. While the transceiver is ON, hold down [SET] for 1 second.
 - Enters the Quick Set mode, and a setting item is displayed.
2. Push [UP▲] or [▼DN] to select an item.
3. Rotate the [MAIN DIAL] to set a value or option for the selected item.
4. Repeat steps 2 and 3 to set other items.
5. Push [SET] to exit the Quick Set mode.

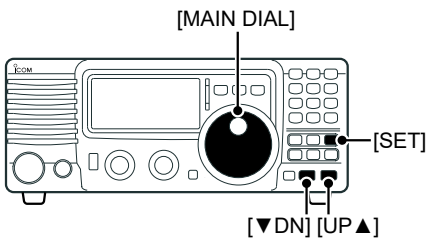

◇ Initial Set mode operation

1. Turn OFF the transceiver.
2. While holding down [SET], push [PWR] to turn ON the transceiver.
 - Enters the Initial Set mode and a setting item is displayed.
3. Push [UP▲] or [▼DN] to select an item.
4. Rotate the [MAIN DIAL] to set a value or option for the selected item.
5. Repeat steps 2 and 3 to set other items.
6. Hold down [PWR] for 1 second to turn OFF the transceiver.
7. Push [PWR] to turn ON the transceiver with the revised settings.

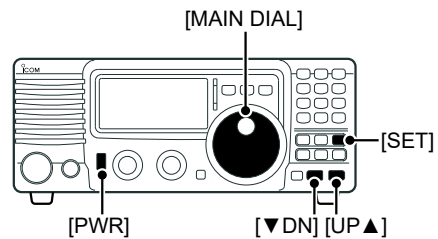

Quick Set mode items

NOTE: The default settings described below are for the USA version transceiver. The default settings may differ, depending on your transceiver version.

LSB
RF POWER

RF Power (Default: H)

Sets the RF output power.
• Range: L (minimum), 1 ~ 99, and H (maximum)

LSB
MIC GAIN

Mic Gain (Default: 50)

Adjusts the microphone gain.
• Range: 0 ~ 99, and H (maximum)

LSB
VOX GAIN

VOX Gain (Default: 50)

Adjusts the VOX gain for the VOX (Voice Activated transmit) function.
• Range: 0 ~ 99

LSB
VOX DELY

VOX Delay (Default: 10 (1.0 second))

Adjusts the VOX delay time.
• Range: 0 ~ 20 (2.0 seconds) in 0.1 second steps.

LSB
AN VOX

Anti VOX Level (Default: 50)

Adjusts Anti-VOX gain for the VOX operation.
• Range: 0 ~ 99

LSB
CW PITCH

CW Pitch (Default: 60 (600 Hz))

Sets the CW tone pitch
• Range: 30 (300 Hz) ~ 90 (900 Hz) in 10 Hz steps.

LSB
BK-IN

BK-IN (Default: oF)

Sets the Break-in type for the CW operation.
• Option: oF (OFF), SE (Semi break-in), FL (Full break-in)

LSB
BK-DELAY

BK-IN Delay (Default: 7)

Sets the Break-in delay time for the CW semi break-in operation.
• Range: 2 ~ 13 (dots.)

LSB
KEY SPD

Key Speed (Default: 20)

Adjusts the CW keying speed.
• Range: 6 ~ 60 (wpm.)
① Some values cannot be set between 6 and 60.

LSB
KEY RAT

Key Ratio (Default: 30 (3.0))

Sets the CW key ratio (or weight.)
• Range: 28 (2.8) ~ 45 (4.5.)

LSB
TON 2 125

RTTY Mark Tone (Default: 2125)

Selects the Mark tone frequency for RTTY operation.
• Option: 1275, 1615, 2125 (Hz)

LSB
SIFT 850

RTTY Shift (Default: 170 Hz)

Selects the RTTY shift.
• Option: 170, 200, 425, 850 (Hz)

LSB
DIMMER

Dimmer (Default: HI)

Selects the display backlight brightness.
• Option: oF (OFF), Lo (Dim), HI (Bright)

Initial Set mode items

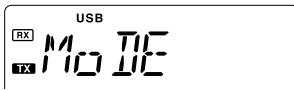
**Mode Select**

Displays or inhibits the mode selection by pushing [MODE]. Push [MODE] to select an operating mode you want to set, and then rotate [MAIN DIAL] to set it ON or OFF. All the operating modes are ON as default.

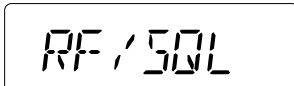
**RF/SQL VR** (Default: rS)

Selects the function of the [RF/SQL] control.

- Option: rS (RF/Squelch), At (Squelch in the AM modes and RF gain in the SSB, CW, and RTTY modes), Sq (Squelch)

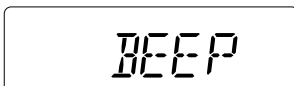
**Beep** (Default: on)

Turns the confirmation beep sound ON or OFF.

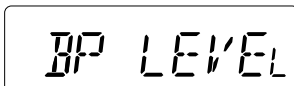
**Beep Level** (Default: 50)

Adjusts the confirmation beep level.

- Range: 1 ~ 99

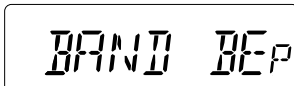
**Band Edge Beep** (Default: on)

Turns the Band Edge Beep ON or OFF.

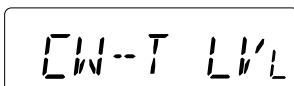
**Side Tone Level** (Default: 30)

Adjusts the CW side-tone output level

- Range: 1 ~ 99

① Make sure the Break-in function is OFF, and SQLS is set to Low to use the CW side-tone.

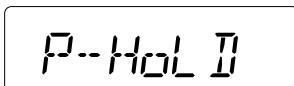
**Meter Peak Hold** (Default: on)

Turns the Meter Peak Hold function ON or OFF.

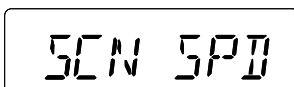
**Scan Speed** (Default: HI)

Sets the scan speed.

- Option: Lo (Low), HI (High)

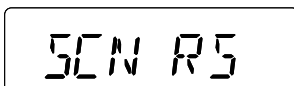
**SCAN Resume** (Default: on)

Turns the Scan Resume function ON or OFF. A scan pauses for 10 seconds if the signal is detected, 2 seconds after the signal disappears, the scan resumes.

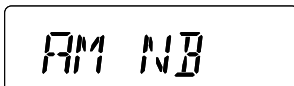
**AM Noise Blanker** (Default: on)

Turns the Noise Blanker function in the AM mode ON or OFF.

① The Noise Blanker function may degrade the audio, such as regular AM radio broadcasts.

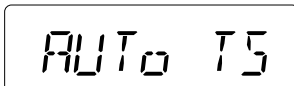
**Auto TS** (Default: on)

Sets the Auto Tuning Step function for [MAIN DIAL]. When rapidly rotating [MAIN DIAL], the tuning step automatically changes according to the rotation speed.

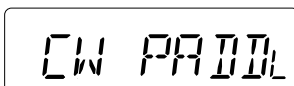
**Key Type** (Default: n)

Selects the CW paddle type.

- Option: n (Normal), r (Reverse), oF (for a straight key), ud (Uses microphone's [UP]/[DN] keys instead of the paddle.)

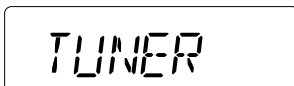
**Tuner Type (TUNER)** (Default: no)

Selects the tuner type when an optional antenna tuner is connected.

- Option: no (No tuner), 4 (AH-4 or AH-740), 18 (AT-180)

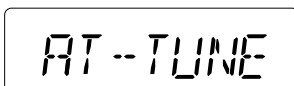
**Auto Tune** (Default: oF)

Turn the AT-180's automatic tune ON or OFF if the SWR is poor (1.5–3).

① When the function is ON, an automatic tune starts even when the tuner is turned OFF.

Initial Set mode items

PTT-TUNE

PTT Tune (Default: oF)

Select whether or not an optional AH-4, AH-740, or AT-180 AUTOMATIC ANTENNA TUNER automatically starts tuning when the [PTT] is pushed.

SP LANG

Speech Language (Default: En)

Select the speech language.

- Option: JP (Japanese), En (English)

① An optional UT-102 VOICE SYNTHESIZER UNIT (discontinued product) must be installed.

SP SPD

Speech Speed (Default: HI)

Select the output speed by the voice synthesizer unit.

- Option: HI (Fast), Lo (Slow)

① An optional UT-102 VOICE SYNTHESIZER UNIT (discontinued product) must be installed.

SP MET

Speech S-meter Level (Default: on)

Turns the S-meter level announcement ON or OFF.

- oF: The operating mode and the operating frequency are announced.
- on: The signal strength level, the operating mode, and the operating frequency are announced.

① An optional UT-102 VOICE SYNTHESIZER UNIT (discontinued product) must be installed.

CI-V BAUD

CI-V Baud Rate (Default: At)

Sets the baud rate for the CI-V data transferring.

- Option: 3 (300 bps), 12 (1200 bps), 48 (4800 bps), 96 (9600 bps), HI (19200 bps), At (Auto)

CI-V ADDR

CI-V Address (Default: 5E)

Sets the CI-V Icom standard address in hexadecimal code.

- Option: 01 ~ 7F

CI-V TRN

CI-V Transceive (Default: on)

Turns the CI-V transceive function ON or OFF.

CI-V 731

CI-V 731 Mode (Default: oF)

When connecting the IC-718 to the IC-735 for transceive operation, you must convert the operating frequency data from 5 bytes to 4 bytes.

① Set to "on" when operating the IC-718 with the IC-735.

FIL no

Option Filter (Default: no)

Select an optional IF filter you want to use.

- Option: no, 52A (500 Hz), 53A (250 Hz), 222 (1.8 kHz), 96 (2.8 kHz), 257 (3.3 kHz)

EXP FIL

Expanded Filter Selection (Default: oF)

Turns the Expanded filter (Wide or Narrow) ON or OFF.

Push [MODE] several times to select an operating mode you want to set, and then rotate [MAIN DIAL] to set the expanded filter ON or OFF.

WIDE^{CW} THU**Filter Selection (WIDE/NARW)** (Default: WIDE=THU, NARW=NoR)

Select an IF filter for the Wide or Narrow bandwidth in each operating mode.

Push [MODE] several times to select an operating mode you want to set, and then rotate [MAIN DIAL] to select a filter.

① Settable only in the mode that the Expanded Filter Selection is ON.

NARW^{AM} NoR

◇ General

- Frequency coverage: (Unit: MHz)

| | | |
|-------------|-----------------------|----|
| Receiver | 0.030000 ~ 29.999999 | *1 |
| Transmitter | 1.800000 ~ 1.999999 | *2 |
| | 3.500000 ~ 3.999999 | *2 |
| | 7.000000 ~ 7.300000 | *2 |
| | 10.100000 ~ 10.150000 | |
| | 14.000000 ~ 14.350000 | |
| | 18.068000 ~ 18.168000 | |
| | 21.000000 ~ 21.450000 | |
| | 24.890000 ~ 24.990000 | |
| | 28.000000 ~ 29.700000 | |
- *1 Guaranteed range: 0.5 ~ 29.99999 MHz
- *2 Varies depending on the transceiver version.
- Operating Modes: USB, LSB, CW, RTTY, AM
- Number of memory channels: 101 (99 regular, 2 scan edges)
- Frequency stability: Less than ± 200 Hz from 1 minute to 60 minutes after power on.
After that rate of stability less than ± 30 Hz/hour at $+25^{\circ}\text{C}$ ($+77^{\circ}\text{F}$).
Temperature fluctuations $0^{\circ}\text{C} \sim +50^{\circ}\text{C}$ ($+32^{\circ}\text{F} \sim +122^{\circ}\text{F}$) less than ± 350 Hz.
- Power supply requirement: 13.8 V DC $\pm 15\%$ (negative ground)
- Current drain:

| | | |
|----------|---------------|--------|
| Receive | Standby | 1.3 A |
| | Maximum audio | 2.0 A |
| Transmit | Maximum power | 20.0 A |
- Operating temperature range: $-10^{\circ}\text{C} \sim +60^{\circ}\text{C}$, $+14^{\circ}\text{F} \sim +140^{\circ}\text{F}$
- Antenna impedance: 50 Ω unbalanced
- Dimensions (Approximate, projections not included):
240 (W) \times 95 (H) \times 239 (D) mm
9.4 (W) \times 3.7 (H) \times 9.4 (D) in
- Weight (Approximate): 3.8 kg, 8.4 lb

◇ Transmitter

- Transmit output power:

| | |
|---------------|-------------|
| SSB, CW, RTTY | 2 W ~ 100 W |
| AM | 2 W ~ 35 W |
- Modulation system:

| | |
|-----|----------------------|
| SSB | Balanced modulation |
| AM | Low level modulation |
- Spurious emissions: Less than -50 dB below peak output power
- Carrier suppression: More than 40 dB
- Unwanted sideband suppression: More than 50 dB
- Microphone impedance: 600 Ω

◇ Receiver

- Receive system: Double-conversion superheterodyne system
- Sensitivity:

| | |
|-------------------------|--|
| SSB/CW/RTTY (10 dB S/N) | 0.16 μV (1.800 – 29.999999 MHz) |
| AM (10 dB S/N) | 13 μV (0.500 – 1.799999 MHz) |
| | 2.0 μV (1.800 – 29.999999 MHz) |
- Squelch sensitivity (threshold):

| | |
|---------------|-----------------------------|
| SSB, CW, RTTY | Less than 5.6 μV |
|---------------|-----------------------------|
- Selectivity:

| | |
|---------------|-----------------------------|
| SSB, CW, RTTY | More than 2.1 kHz/ -6 dB |
| | Less than 4.5 kHz/ -60 dB |
| AM | More than 6 kHz/ -6 dB |
| | Less than 20 kHz/ -40 dB |
- Spurious and image rejection ratio: More than 70 dB (1.8–29.999999 MHz)
- RIT variable range: ± 1200 Hz
- Audio output power: More than 2.0 W at 10% distortion with an 8 Ω load (at 13.8 V DC)

① All stated specifications are typical and subject to change without notice or obligation.

(As of November 2023)

Microphones

HM-219 HAND MICROPHONE

The same as supplied.

SM-30 DESKTOP MICROPHONE

SM-50 DESKTOP MICROPHONE

Speaker

SP-41 EXTERNAL SPEAKER

Antennas

AT-180 HF + 50 MHz AUTOMATIC ANTENNA TUNER

AH-4 HF + 50 MHz AUTOMATIC ANTENNA TUNER

To tune a long wire antenna for portable or mobile HF operation.

Input power rating: 120 W

AH-2b ANTENNA ELEMENT

A 2.5 m long antenna element for mobile operation with the AH-4.

Frequency coverage:

3.5 MHz ~ 28 MHz bands with the AH-4

AH-710 FOLDED DIPOLE ANTENNA

AH-730 AUTOMATIC ANTENNA TUNER

Input power rating: 150 W Maximum

AH-740 AUTOMATIC TUNING ANTENNA

Frequency coverage with 1.54 m whip antenna:

2.5 MHz ~ 29.9999 MHz

Cables

OPC-599 ADAPTER CABLE

13-pin, ACC connector to 7-pin +8-pin ACC connectors.

OPC-2321 CONTROL CABLE

To connect the AH-740

Approximately 6 m, 19.7 feet

Others

MB-23 CARRYING HANDLE

MB-118 MOBILE MOUNTING BRACKET

① Some options may not be available in some countries. Ask your dealer for details.

◇ Troubleshooting

The following chart is designed to help you correct problems which are not equipment malfunctions. If you are not able to locate the cause of a problem or solve it through the use of this chart, contact your nearest Icom Dealer or Service Center.

| | Problem | Possible cause | Solution | Ref. |
|----------|--|--|--|--|
| RECEIVE | Power does not turn ON when [PWR] is pushed. | <ul style="list-style-type: none"> DC power cable is improperly connected. Fuse is blown. The external power supply is turned OFF. | <ul style="list-style-type: none"> Properly reconnect the DC power cable. Turn ON the external power supply. Find and repair the cause of the problem, and then replace the blown fuse with a new one. | p. 6 p. 6 p. 6 |
| | No sound is heard from the speaker. | <ul style="list-style-type: none"> The audio level is too low. The squelch is closed. The transceiver is in the transmitting mode. | <ul style="list-style-type: none"> Rotate [AF] control clockwise to obtain a suitable listening level. Rotate [RF/SQL] to around the 10 o'clock position to open the squelch, and adjust the squelch level. Turn off the transmit mode. | p. 7 p. 10 – |
| | Sensitivity is too low, and only strong signals are heard. | <ul style="list-style-type: none"> The Antenna is not properly connected. The antenna for another band is connected. The antenna is not properly tuned. The attenuator is activated. | <ul style="list-style-type: none"> Reconnect the antenna connector. Connect an antenna suitable for the operating band. Hold down [TUNER] for 2 seconds to manually tune the antenna. Turn OFF the Attenuator. | p. 5 p. 3 p. 11 |
| | Receive audio is distorted. | <ul style="list-style-type: none"> The operating mode is not selected correctly. The IF SHIFT function is activated. The Noise blanker function is activated. The preamp is activated. For the USA version, Noise Reduction function is activated and set too high. | <ul style="list-style-type: none"> Select the correct operating mode. Rotate [SHIFT] to the center position. Push [NB] to turn OFF the function. Push [P.AMP] to turn OFF the function. Set the [NR] control for maximum readability. | p. 8 p. 12 p. 11 p. 11 p. 15 |
| TRANSMIT | Cannot transmit. | <ul style="list-style-type: none"> The operating frequency is outside the selected ham band. | <ul style="list-style-type: none"> Set the frequency within the selected ham band. | p. 9 |
| | Output power is too low. | <ul style="list-style-type: none"> RF power is too low. The microphone gain is too low. The selected antenna is for a different band. The antenna is not properly tuned. | <ul style="list-style-type: none"> Set [RF POWER] to a suitable level. Set [MIC GAIN] to a suitable level. Select an antenna suitable for the operating frequency. Hold down [TUNER]. | p. 10 p. 10 – p. 1 |
| | Cannot contact with another station. | <ul style="list-style-type: none"> The RIT function is activated. The Split frequency function is activated. | <ul style="list-style-type: none"> Push [RIT] to turn OFF the function. Push [SPLIT] to turn OFF the function. | p. 11 p. 15 |
| | Transmitted signal is distorted. | <ul style="list-style-type: none"> The microphone gain is too high. The microphone compressor function is activated. | <ul style="list-style-type: none"> Set [MIC GAIN] to a suitable level. Push [COMP] to turn OFF the Microphone compressor function. | p. 10 p. 16 |
| SCAN | Programmed scan does not stop. | <ul style="list-style-type: none"> Squelch is open. [RF/SQL] is assigned to RF gain control and squelch is open. | <ul style="list-style-type: none"> Set [RF/SQL] to the threshold point. Reset [RF/SQL] control assigned and set it to the threshold point. | p. 10 p. 10 |
| | Programmed scan does not start. | <ul style="list-style-type: none"> The same frequencies have been entered in scan edge memory channels P1 and P2. | <ul style="list-style-type: none"> Enter different frequencies in Scan Edge memory channels P1 and P2. | p. 17 |
| | Memory scan does not start. | <ul style="list-style-type: none"> 2 or more memory channels have not been entered. | <ul style="list-style-type: none"> Enter 2 or more memory channels. | p. 17 |
| DISPLAY | The displayed frequency does not change when rotating the main dial. | <ul style="list-style-type: none"> The dial lock function is activated. A Quick Set mode screen is selected. The internal CPU has malfunctioned. | <ul style="list-style-type: none"> Push [LOCK] to deactivate the function. Push [SET] to exit the Quick Set mode. Reset the CPU. | p. 9 p. 18 p. 7 |

◇ Replacing the circuitry fuse

The 13.8 V DC from the DC power source is applied to all units in the IC-718 through the circuitry fuse. The fuse is in the MAIN unit.

1. Remove the top cover of the transceiver. (①)
2. Replace the circuitry fuse to a brand-new one. (②)
3. Replace the top cover.

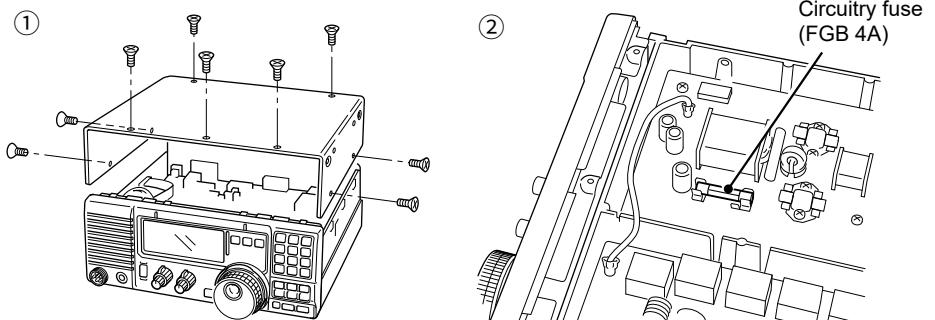

For amateur base station installations, it is recommended that the forwards clearance in front of the antenna array is calculated relative to the EIRP (Effective Isotropic Radiated Power). The clearance height below the antenna array can be determined in most cases from the RF power at the antenna input terminals.

As different exposure limits have been recommended for different frequencies, a relative table shows a guideline for installation considerations.

Below 10 MHz, the recommended limits are specified in terms of V/m or A/m fields as they are likely to fall within the near-field region. Similarly, antennae may be physically short in terms of electrical length and the installation will require some antenna matching device which can create high intensity magnetic fields. Analysis of such MF installations is best considered in association with published guidance notes such as the FCC OET Bulletin 65 Edition 97-01 and its annexes relative to amateur transmitter installations. Further information can be found at <http://www.arrl.org/>

- Typical amateur radio installation

Exposure distance assumes that the predominant radiation pattern is forwards and that radiation vertically downwards is at unity gain (sidelobe suppression is equal to main lobe gain). This is true of almost every gain antenna today. Exposed persons are assumed to be beneath the antenna array and have a typical height to 1.8 m. The figures assume the worst case emission of constant carrier.

For the bands 10 MHz and higher the following power density limits are recommended :

| | |
|-----------|----------|
| 10–30 MHz | 2 W/sq m |
|-----------|----------|

Watts (EIRP)/ Clearance heights

| | |
|------|---------|
| 1 | 2.1 (m) |
| 10 | 2.8 |
| 25 | 3.4 |
| 100 | 5 |
| 1000 | 12 |

Watts (EIRP)/ Forward clearance

| | |
|---------|-------|
| 100 | 2 (m) |
| 1,000 | 6.5 |
| 10,000 | 20 |
| 100,000 | 65 |

In all cases any possible risk depends on the transmitter being activated for long periods. (actual recommendation limits are specified as an average of 6 minutes) Normally the transmitter is not active for long periods of time. Some radio licenses will require that a timer circuit automatically cuts the transmitter after 1–2 minutes etc.

Similarly some types of transmitter, SSB, CW, AM, etc. have a lower 'average' output power and the perceived risk is even lower.

| | |
|---------------------------------|---------------------------------|
| Number | N |
| 1 Hz/10 Hz tuning steps 4 | Noise Blanker 11 |
| A | Noise Reduction 15 |
| Accessories i | Notch Filter 15 |
| Attenuator 11 | O |
| Auto tuning step function ... 9 | Operating band 8 |
| B | Operating mode 8 |
| Band Edge Beep 9 | Options 23 |
| Band Stacking Register 8 | P |
| C | Panel |
| Connecting | Display 4 |
| Antenna 5 | Front 1 |
| DC power supply 6 | Rear 3 |
| Vehicle's battery 6 | Power |
| Connector 3 | First applying 7 |
| D | ON or OFF 7 |
| DC power supply 6 | Preamplifiers 11 |
| Desktop stand 5 | PRECAUTIONS i |
| Dial Lock function 9 | Q |
| Display 4 | Quick Set mode 18 |
| F | Quick tuning step 9 |
| FCC information iii | R |
| Filter | Resetting 7 |
| Expanded 14 | RF gain 10 |
| IF filter 13 | RIT function 11 |
| Notch Filter 15 | S |
| Optional 13 | Set mode 18 |
| Fine tuning step 9 | Specifications 22 |
| Frequency | Split frequency operation .. 15 |
| Directly entering 9 | SQL level 10 |
| Using the Main Dial 9 | Squelch 10 |
| G | T |
| Grounding 5 | Transmit output power 10 |
| I | V |
| IF shift function 12 | VFO mode 8 |
| IMPORTANT i | Volume level 7 |
| Indicators | VOX function 16 |
| Function 4 | |
| Lock 4 | |
| Tune 4 | |
| Initial Set mode 18 | |
| K | |
| Keypad 2 | |
| L | |
| LOCK 1 | |
| M | |
| Memory channel 17 | |
| Selecting 17 | |
| Transferring to VFO 17 | |
| Writing 17 | |
| Memory scan 17 | |
| Meter 10 | |
| Meter peak hold 11 | |
| Microphone compressor ... 16 | |
| Mode select 20 | |

DÉFINITIONS EXPLICITES

| TERME | DÉFINITION |
|--------------------------|---|
| ⚠ DANGER ! | Risque d'accident mortel, de blessures corporelles graves ou d'explosion. |
| ⚠ AVERTISSEMENT ! | Risque de blessures corporelles, d'incendie ou de choc électrique. |
| ATTENTION | Risque de dégât matériel. |

PRÉCAUTIONS

⚠ DANGER TENSION À HAUTES RF ! NE JAMAIS toucher l'antenne ou le connecteur de l'antenne pendant une transmission. Cela pourrait causer un choc électrique ou des brûlures.

⚠ DANGER ! NE JAMAIS utiliser l'émetteur-récepteur à proximité de détonateurs électriques non blindés ou dans une atmosphère explosive. Cela pourrait causer une explosion mortelle.

⚠ DANGER ! NE JAMAIS placer l'émetteur-récepteur là où le déploiement de l'airbag peut être bloqué pendant les opérations mobiles.

⚠ AVERTISSEMENT RELATIF À L'EXPOSITION AUX FRÉQUENCES RADIO ! Cet appareil émet des ondes de fréquences radio (RF). Il doit être utilisé avec la plus grande prudence. Pour toutes questions concernant l'exposition aux fréquences radio et sur les règles de sécurité, veuillez consulter le rapport du Bureau Engineering and Technology de la Federal Communications Commission (FCC) sur l'évaluation de la conformité à la réglementation FCC sur l'exposition de l'homme aux champs électromagnétiques de fréquences radio (OET Bulletin 65).

⚠ AVERTISSEMENT ! NE JAMAIS utiliser l'émetteur-récepteur avec des écouteurs, un casque ou tout autre accessoire audio à un niveau sonore élevé. L'utilisation continue à un niveau sonore élevé peut provoquer un bourdonnement dans vos oreilles. Si vous entendez une sonnerie, baissez le niveau sonore ou interrompez l'utilisation.

⚠ AVERTISSEMENT ! NE JAMAIS raccorder le socle [DC 13.8V] sur le panneau arrière de l'émetteur-récepteur à une source de courant alternatif. Cela pourrait causer un incendie ou endommager l'émetteur-récepteur.

⚠ AVERTISSEMENT ! NE JAMAIS raccorder le socle [DC 13.8V] sur le panneau arrière de l'émetteur-récepteur à une source de courant dont la tension est supérieure à 16 V CC. Cela pourrait causer un incendie ou endommager l'émetteur-récepteur.

⚠ AVERTISSEMENT ! NE JAMAIS inverser la polarité du câble d'alimentation CC. Cela pourrait causer un incendie ou endommager l'émetteur-récepteur.

⚠ AVERTISSEMENT ! NE JAMAIS retirer le porte-fusible du câble d'alimentation CC. Un courant excessif provoqué par un court-circuit pourrait causer un incendie ou endommager l'émetteur-récepteur.

⚠ AVERTISSEMENT ! NE JAMAIS permettre que du métal, du fil ou d'autres objets soit au contact de l'intérieur de l'émetteur-récepteur ou raccorder incorrectement les connecteurs sur le panneau arrière. Cela pourrait causer un choc électrique ou endommager l'émetteur-récepteur.

⚠ AVERTISSEMENT ! NE JAMAIS utiliser ou toucher l'émetteur-récepteur avec des mains mouillées. Cela pourrait causer un choc électrique ou endommager l'émetteur-récepteur.

⚠ AVERTISSEMENT ! Coupez immédiatement le courant de l'émetteur-récepteur et enlevez le câble d'alimentation de l'émetteur-récepteur s'il émet une odeur, de la fumée ou un bruit anormal. Contactez votre revendeur ou distributeur Icom pour obtenir des conseils.

⚠ AVERTISSEMENT ! NE JAMAIS placer l'émetteur-récepteur sur un support instable où il risque de se déplacer brusquement ou de tomber. Cela pourrait causer des blessures ou endommager l'émetteur-récepteur.

⚠ AVERTISSEMENT ! NE JAMAIS utiliser l'émetteur-récepteur durant un orage. Cela risquerait de provoquer un choc électrique, un incendie ou d'endommager l'émetteur-récepteur. Toujours débrancher la source d'alimentation et l'antenne avant une tempête.

ATTENTION: NE PAS utiliser l'émetteur-récepteur en conduisant un véhicule. La sécurité de la conduite requiert toute l'attention du conducteur—toute défaillance peut être à l'origine d'un accident.

ATTENTION : NE JAMAIS exposer l'émetteur-récepteur à la pluie, à la neige ou à tout autre liquide. Cela pourrait endommager l'émetteur-récepteur.

ATTENTION : NE JAMAIS changer les réglages internes de l'émetteur-récepteur. Cela pourrait réduire les performances de l'émetteur-récepteur ou l'endommager. La garantie de l'émetteur-récepteur ne couvre pas les problèmes résultant de réglages internes non autorisés.

ATTENTION : NE JAMAIS installer ou placer l'émetteur-récepteur dans un endroit sans ventilation adéquate, ou bloquer tous les orifices de refroidissement sur le dessus, l'arrière, les côtés ou le dessous de l'émetteur-récepteur. La dissipation thermique risque de diminuer et endommager l'émetteur-récepteur.

ATTENTION : NE JAMAIS utiliser de dissolvants agressifs tels que du Benzène ou de l'alcool lors du nettoyage, car ils endommageraient les surfaces de l'émetteur-récepteur. Si la surface est poussiéreuse ou sale, nettoyez-la avec un tissu doux et sec.

ATTENTION : NE JAMAIS laisser l'émetteur-récepteur dans des zones avec des températures inférieures à -10°C ($+14^{\circ}\text{F}$) ou supérieures à $+60^{\circ}\text{C}$ ($+140^{\circ}\text{F}$) pour les opérations mobiles.

ATTENTION : NE JAMAIS placer l'émetteur-récepteur dans des environnements excessivement poussiéreux. Cela pourrait endommager l'émetteur-récepteur.

MISE EN GARDE ! : L'émetteur-récepteur chauffe en cas d'utilisation continue sur une longue durée.

ATTENTION : NE PAS démarrer le moteur du véhicule lorsque l'alimentation de l'émetteur-récepteur est allumée. Les pics de tension d'allumage peuvent endommager l'émetteur-récepteur.

ATTENTION : En cas de connexion d'un amplificateur linéaire, réglez la puissance d'émission de RF de l'émetteur-récepteur de sortie en dessous de la puissance maximale en entrée de l'amplificateur linéaire, au risque dans le cas contraire d'endommager celui-ci.

ATTENTION : Utilisez uniquement les microphones Icom fournis ou en option. Les microphones des autres fabricants risquent de disposer d'affectation de broches différentes, et pourrait endommager le connecteur et/ou l'émetteur-récepteur.

NE placez **JAMAIS** l'émetteur-récepteur dans un endroit non sécurisé pour éviter toute utilisation accidentelle par des personnes non autorisées.

En utilisation mobile, **NE JAMAIS** placer l'émetteur-récepteur dans un environnement chaud ou là où de l'air froid souffle directement dessus.

ATTENTION : **NE PAS** utiliser un émetteur-récepteur embarqué avec le moteur du véhicule arrêté. Toute utilisation de l'émetteur-récepteur moteur arrêté a pour conséquence de vider rapidement la batterie du véhicule.

En utilisation maritime mobile, maintenir l'émetteur-récepteur et le microphone aussi loin que possible du compas de route magnétique afin d'écarter tout risque de déviation de celui-ci.

INFORMATION FCC

Cet appareil est conforme à la partie 15 de la réglementation FCC. Son fonctionnement est soumis à la condition que ce dispositif ne provoque pas d'interférences nuisibles.

Cet équipement a été testé et reconnu conforme aux limites fixées pour un appareil numérique de classe B, conformément au point 15 de la réglementation FCC. Ces limites ont été fixées afin d'assurer une protection raisonnable contre les interférences nocives dans une installation résidentielle.

Cet équipement génère, utilise et peut émettre un rayonnement de fréquence radio. S'il n'a pas été installé conformément aux instructions, il peut par ailleurs créer des interférences perturbant les communications radio. Toutefois, il n'y a aucune garantie que les interférences ne se produiront pas dans une installation particulière. Si cet équipement crée des interférences perturbant la réception de la radio ou de la télévision, comme cela peut être déterminé en éteignant et en allumant l'équipement, l'utilisateur est invité à essayer de corriger l'interférence en prenant une ou plusieurs des mesures ci-après:

- Réorienter ou changer de place l'antenne de réception.
- Éloigner l'équipement et le récepteur.
- Connecter l'équipement sur une prise sur un autre circuit que celui sur lequel le récepteur est connecté.
- Faire appel au revendeur ou à un technicien radio/TV expérimenté.

MISE EN GARDE : Tout changement ou modification, non expressément approuvé par Icom Inc., peut annuler l'autorisation de l'utilisateur à utiliser cet appareil conformément à la réglementation FCC.

Pour le Canada :

L'émetteur/récepteur exempt de licence contenu dans le présent appareil est conforme aux CNR d'Innovation, Sciences et Développement économique Canada (ISDE) applicables aux appareils radio exempts de licence.

L'exploitation est autorisée aux deux conditions suivantes :

- (1) L'appareil ne doit pas produire de brouillage, et
- (2) L'appareil doit accepter tout brouillage radioélectrique subi, même si le brouillage est susceptible d'en compromettre le fonctionnement.

