

GENERAL WIRING (GENERAL WIRING-1)

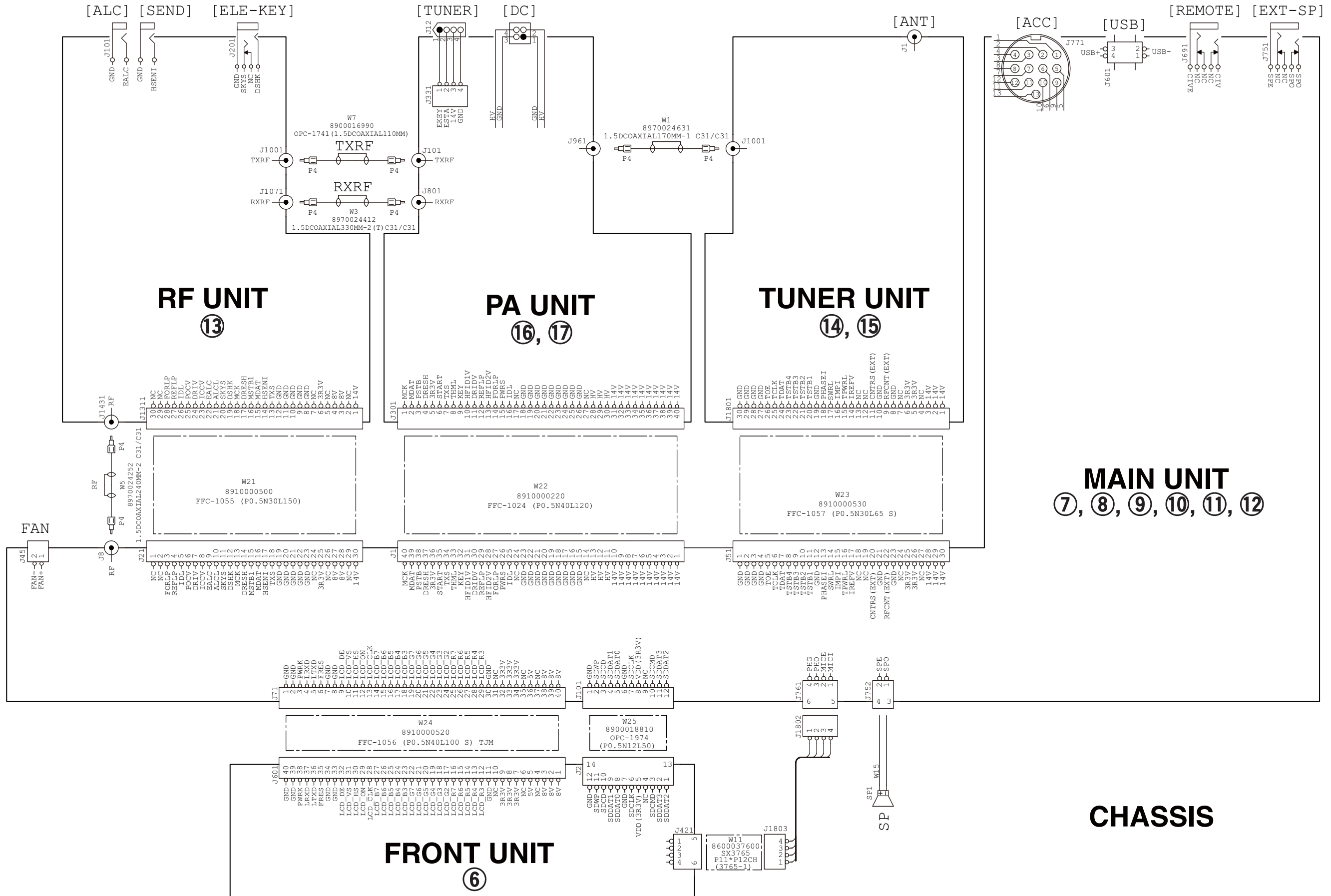

To upgrade quality, some components may be subject to change without notice.

GENERAL WIRING (GENERAL WIRING-2)

FRONT UNIT

⑥

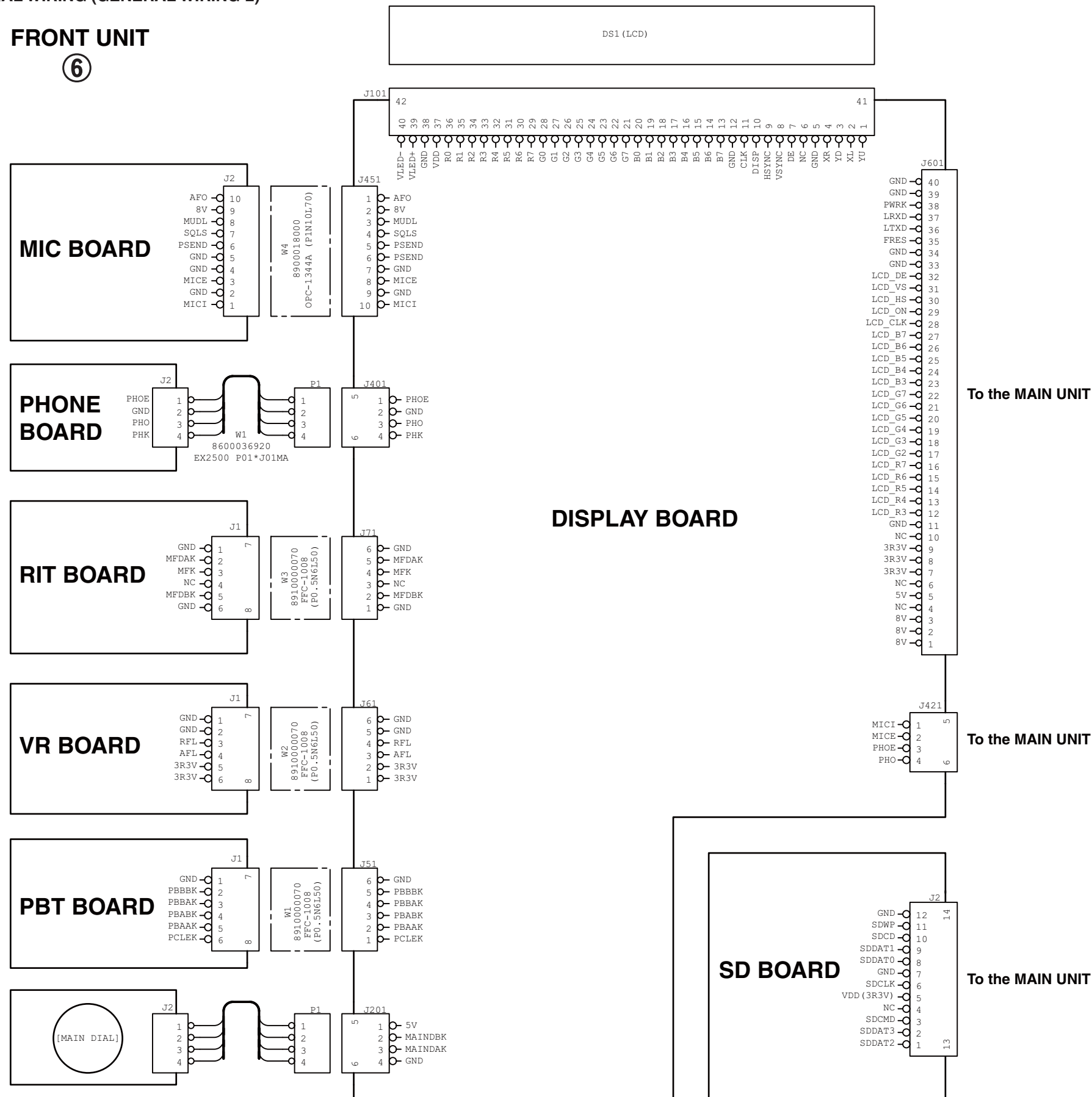

To upgrade quality, some components may be subject to change without notice.

BLOCK DIAGRAM (BLOCK DIAGRAM-1)

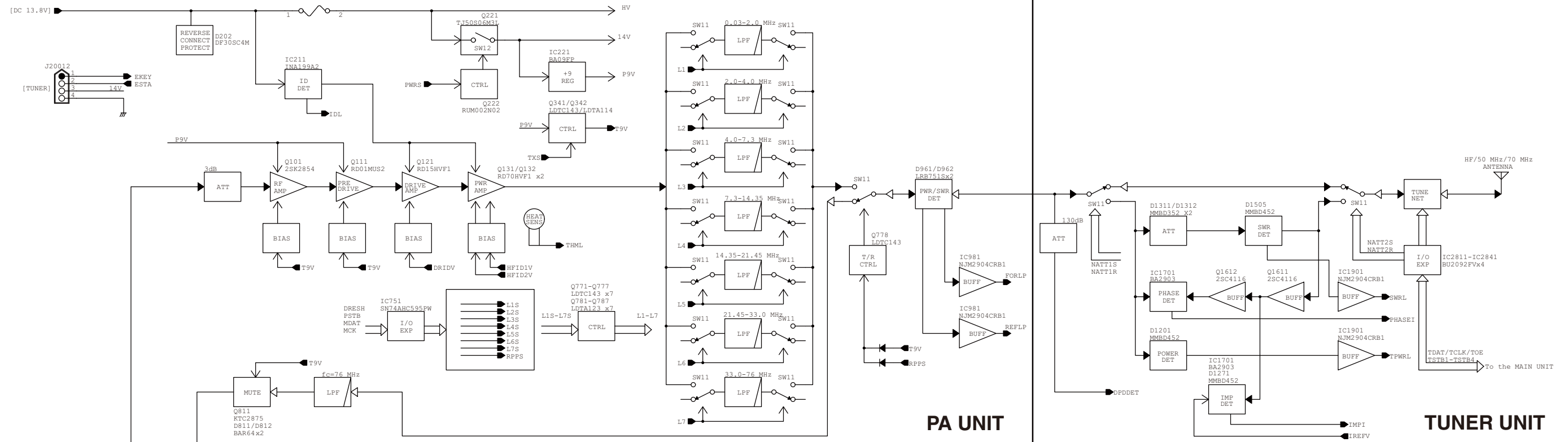

PA UNIT

TUNER UNIT

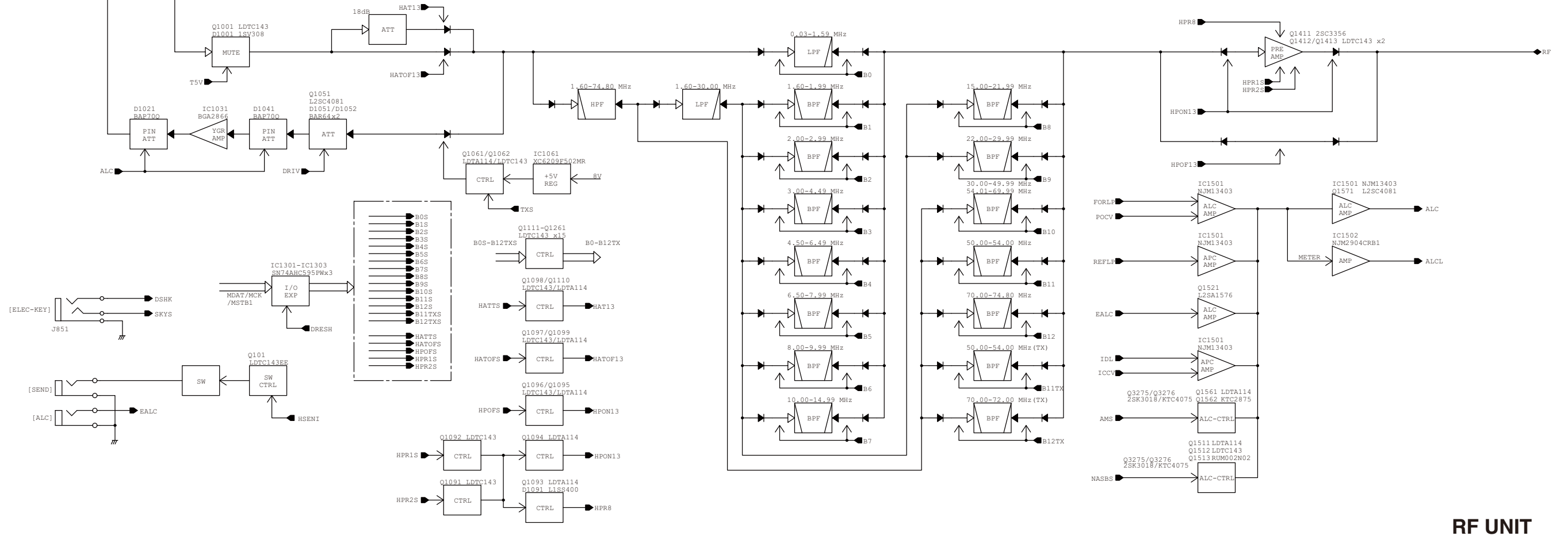

RF UNIT

To upgrade quality, some components may be subject to change without notice.

BLOCK DIAGRAM (BLOCK DIAGRAM-2)

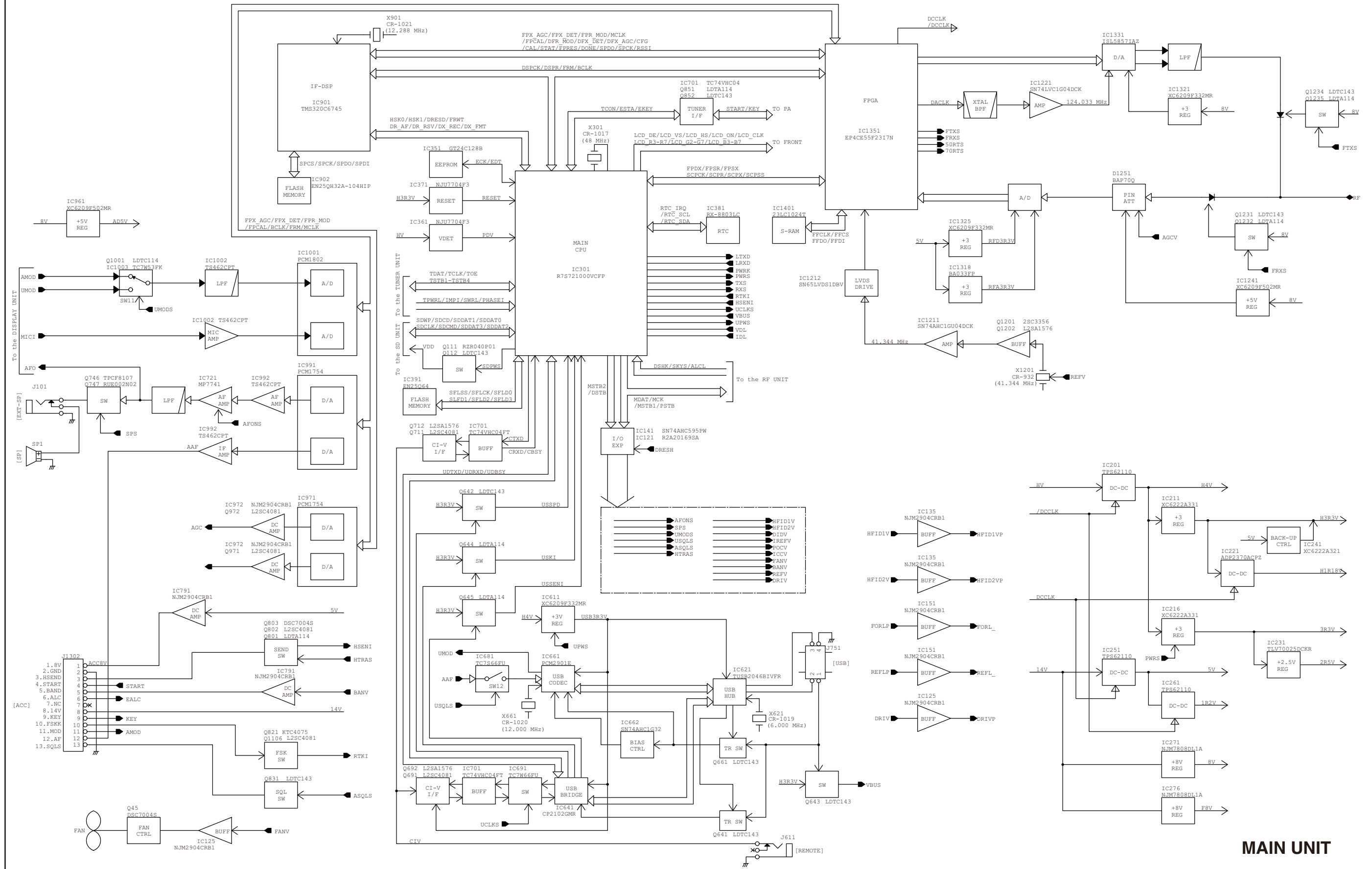

MAIN UNIT

To upgrade quality, some components may be subject to change without notice.

BLOCK DIAGRAM (BLOCK DIAGRAM-3)

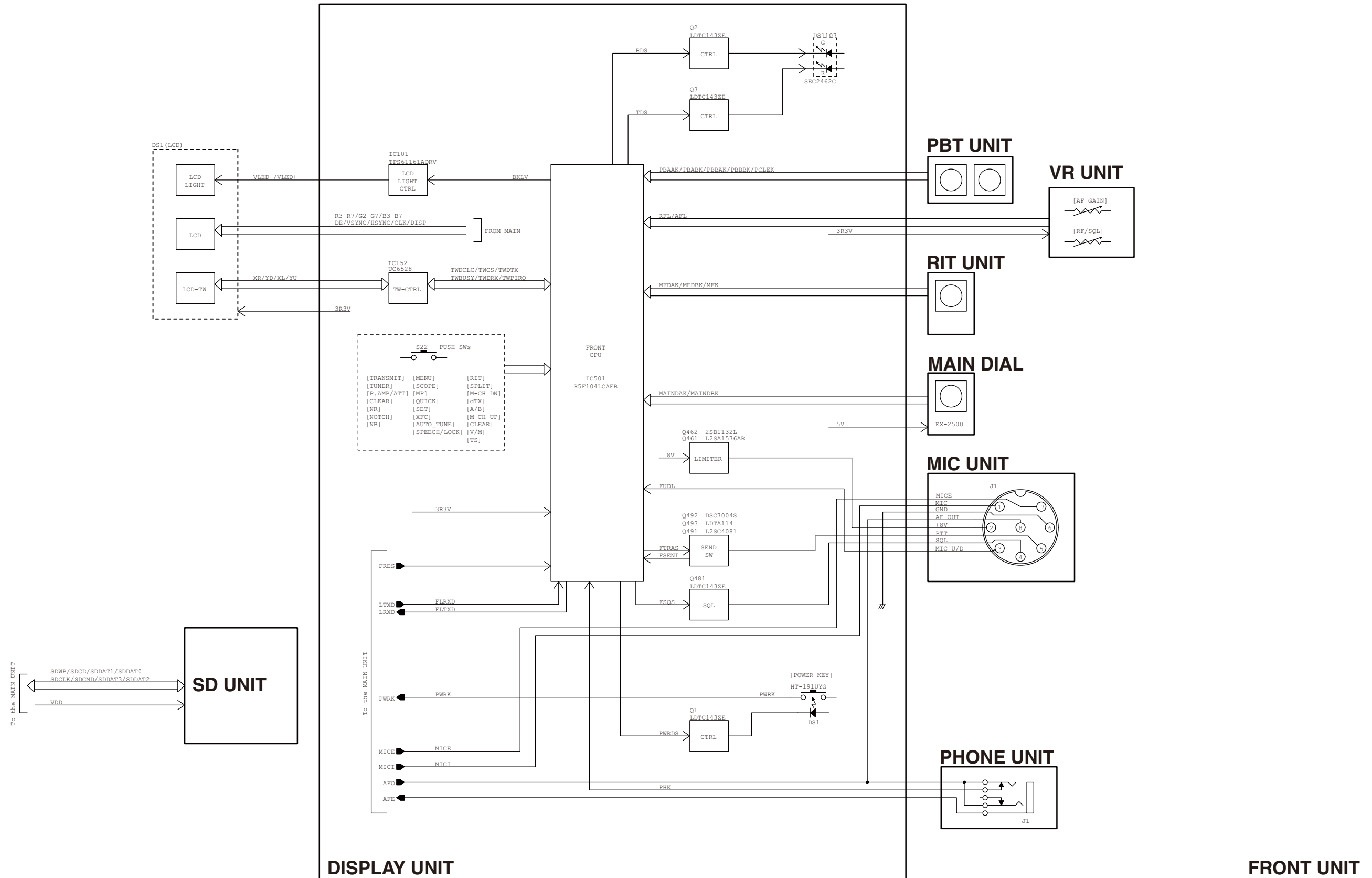

To upgrade quality, some components may be subject to change without notice.

FRONT UNIT

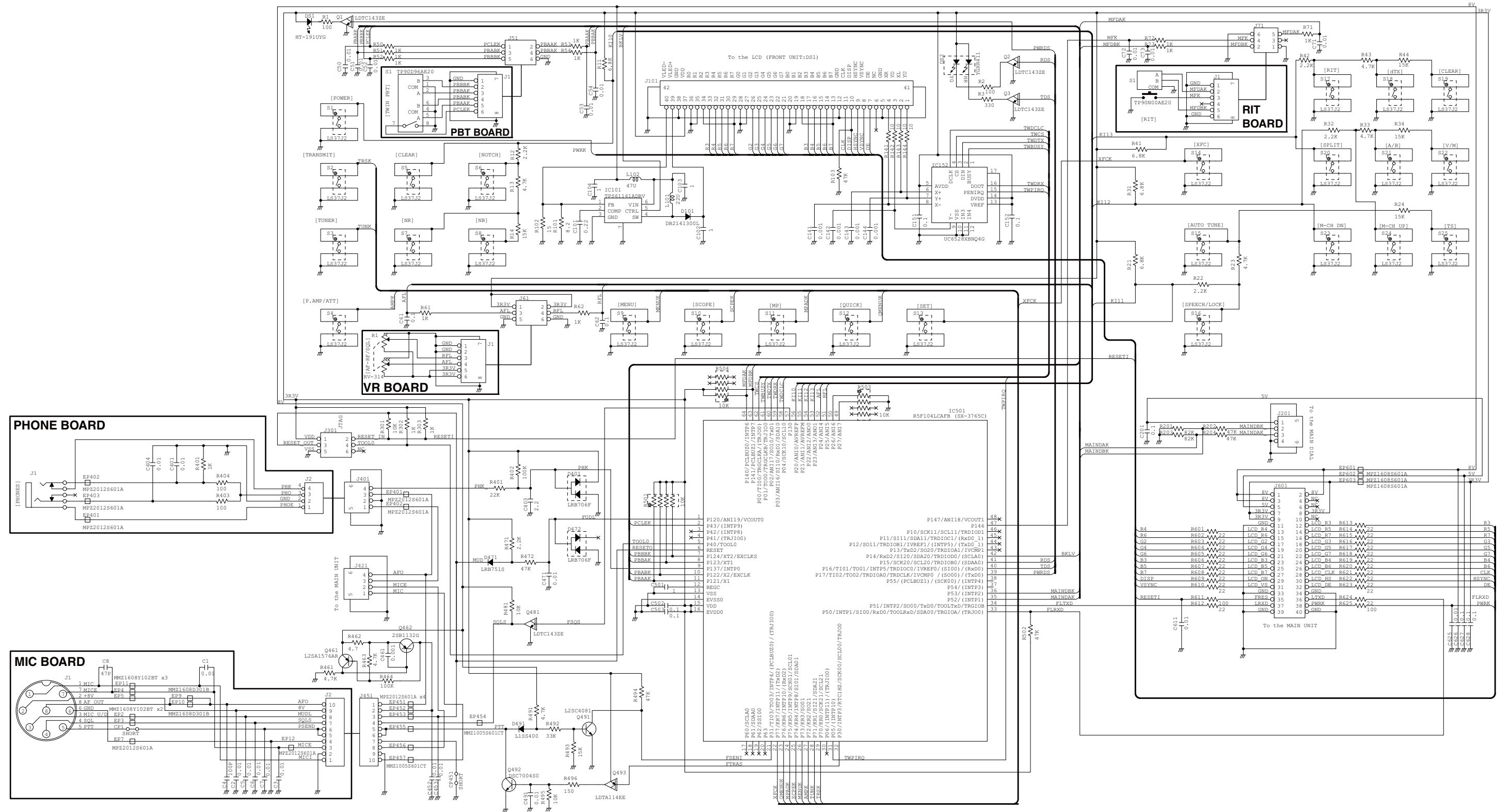

To upgrade quality, some components may be subject to change without notice.

### MAIN UNIT (MAIN-1)

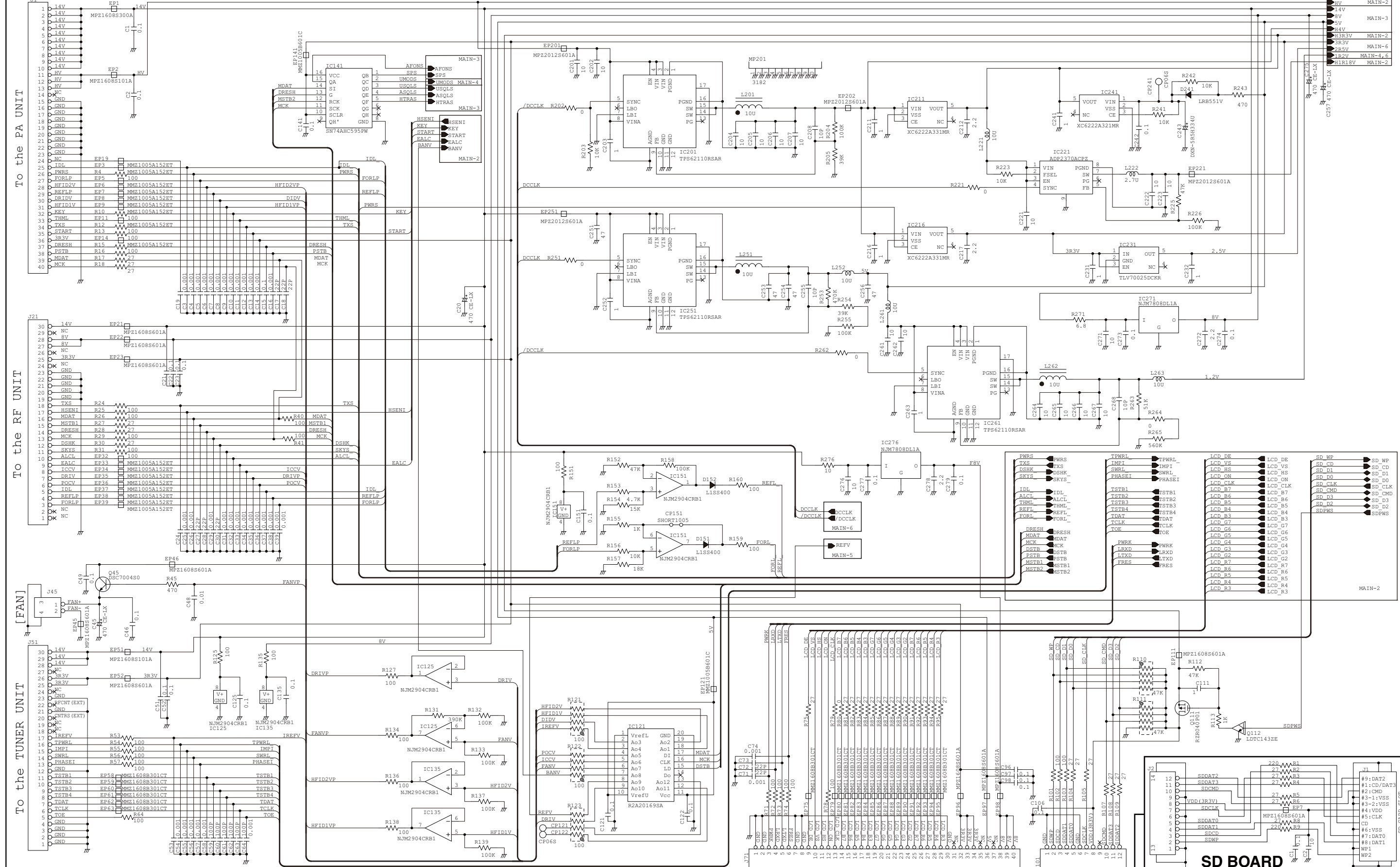

### SD BOARD

To the DISPLAY BOARD

To upgrade quality, some components may be subject to change without notice.

MAIN UNIT (MAIN-2)

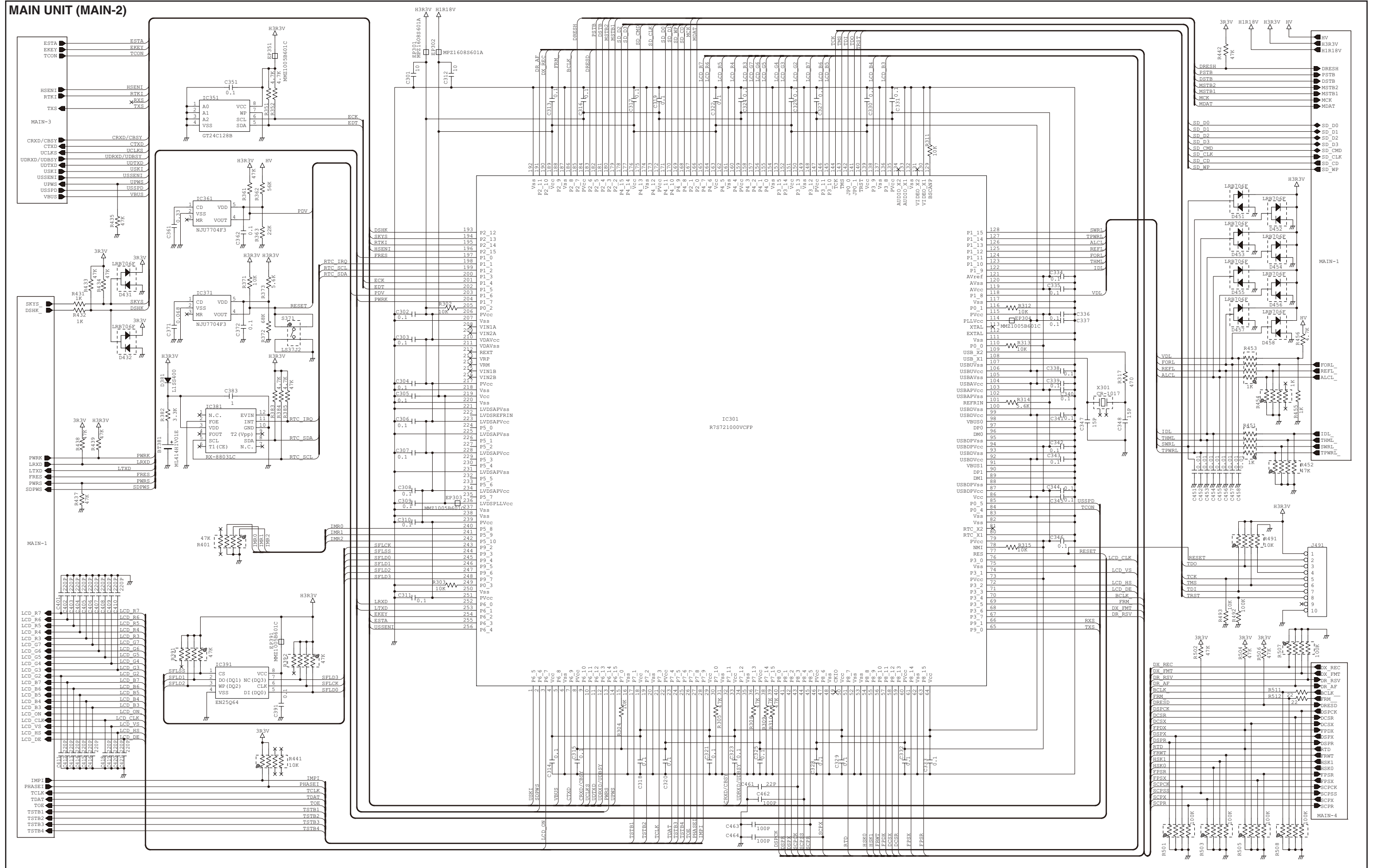

To upgrade quality, some components may be subject to change without notice.

A-7290-3EX-2  
Printed in Japan  
© 2015-2016 Icom Inc.

Icom Inc.



MAIN UNIT (MAIN-3)

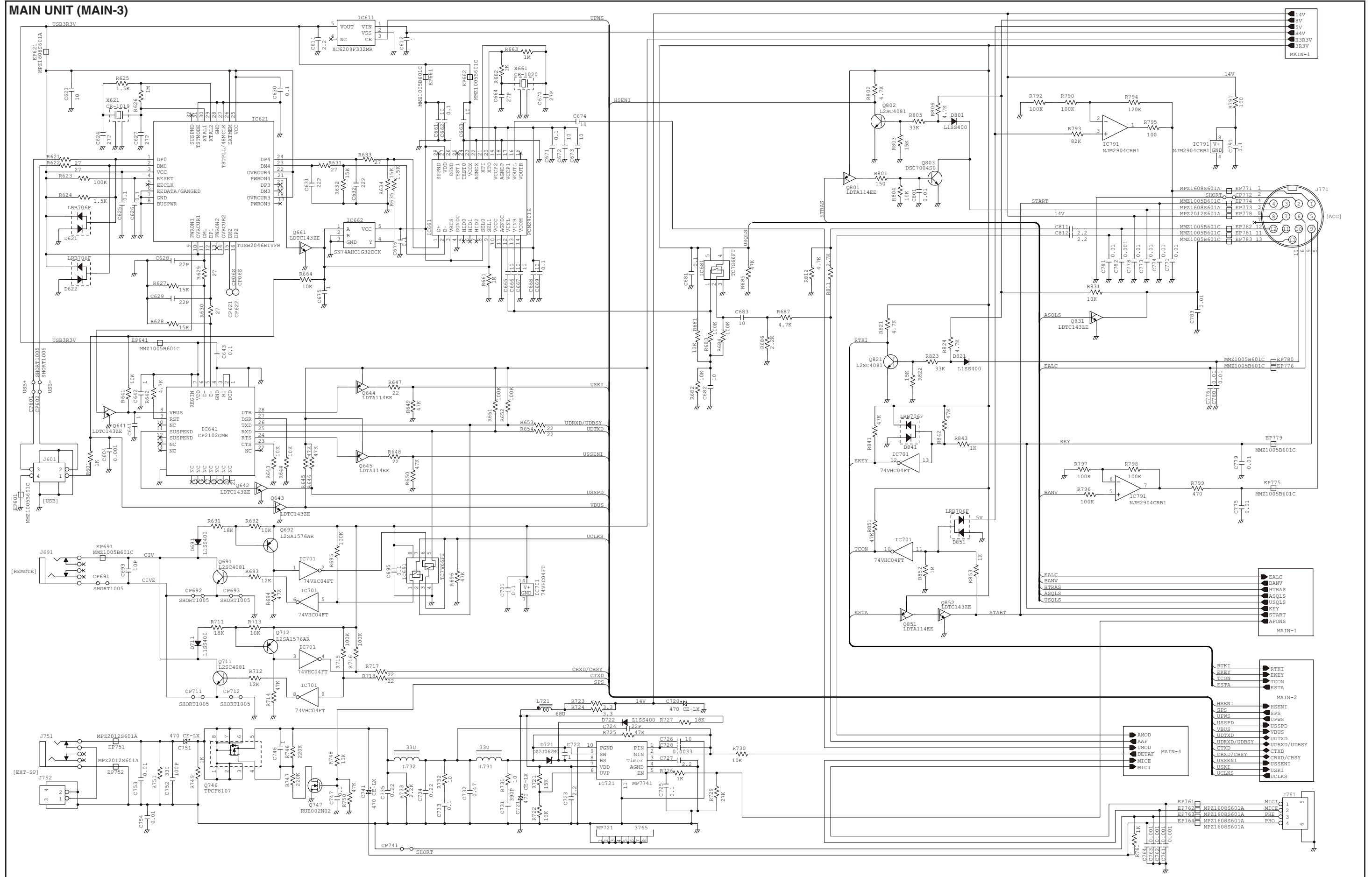

To upgrade quality, some components may be subject to change without notice.

A-7290-3EX-2  
Printed in Japan  
© 2015-2016 Icom Inc.

Icom Inc.



MAIN UNIT (MAIN-5)

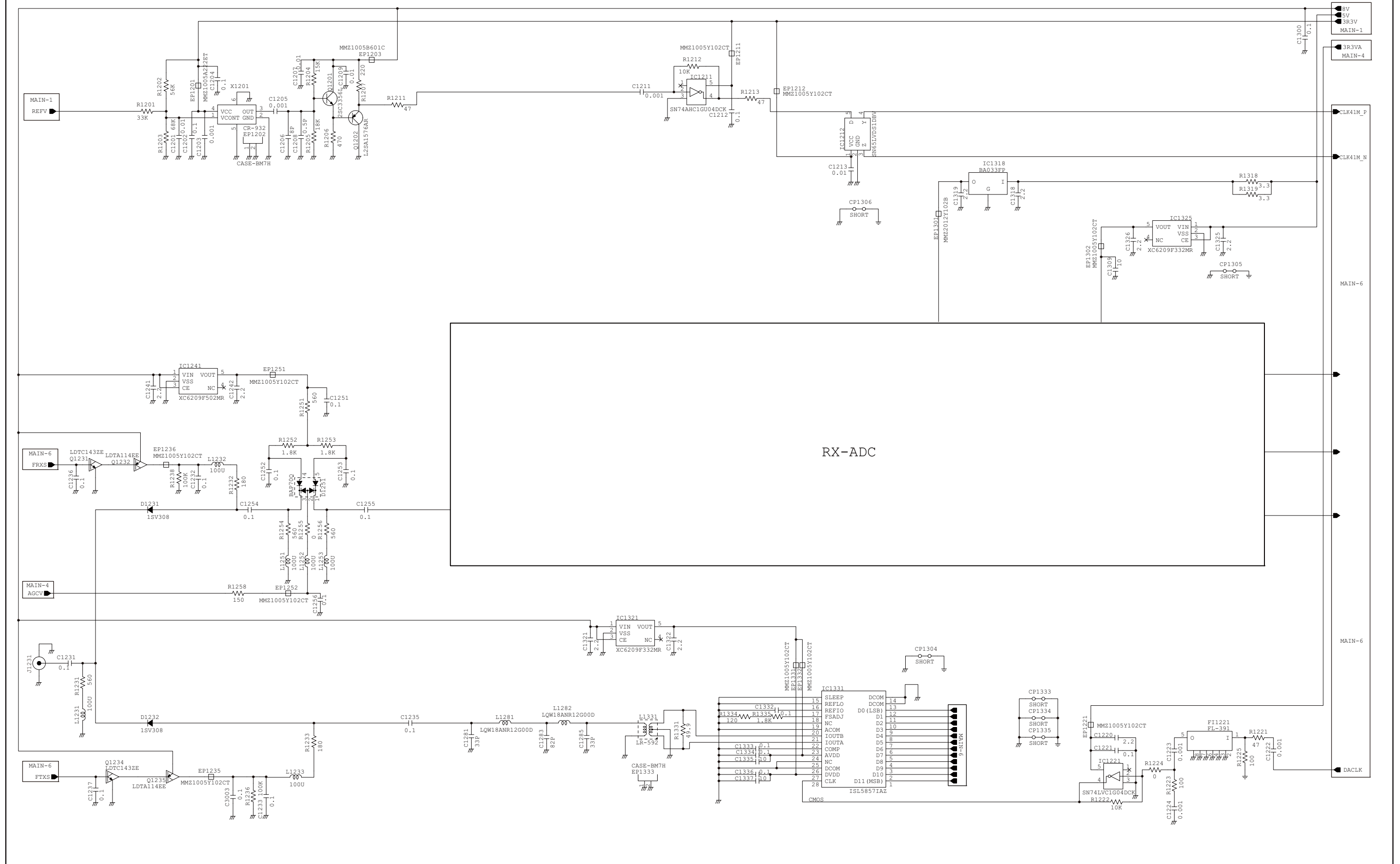

To upgrade quality, some components may be subject to change without notice.

### MAIN UNIT (MAIN-6)

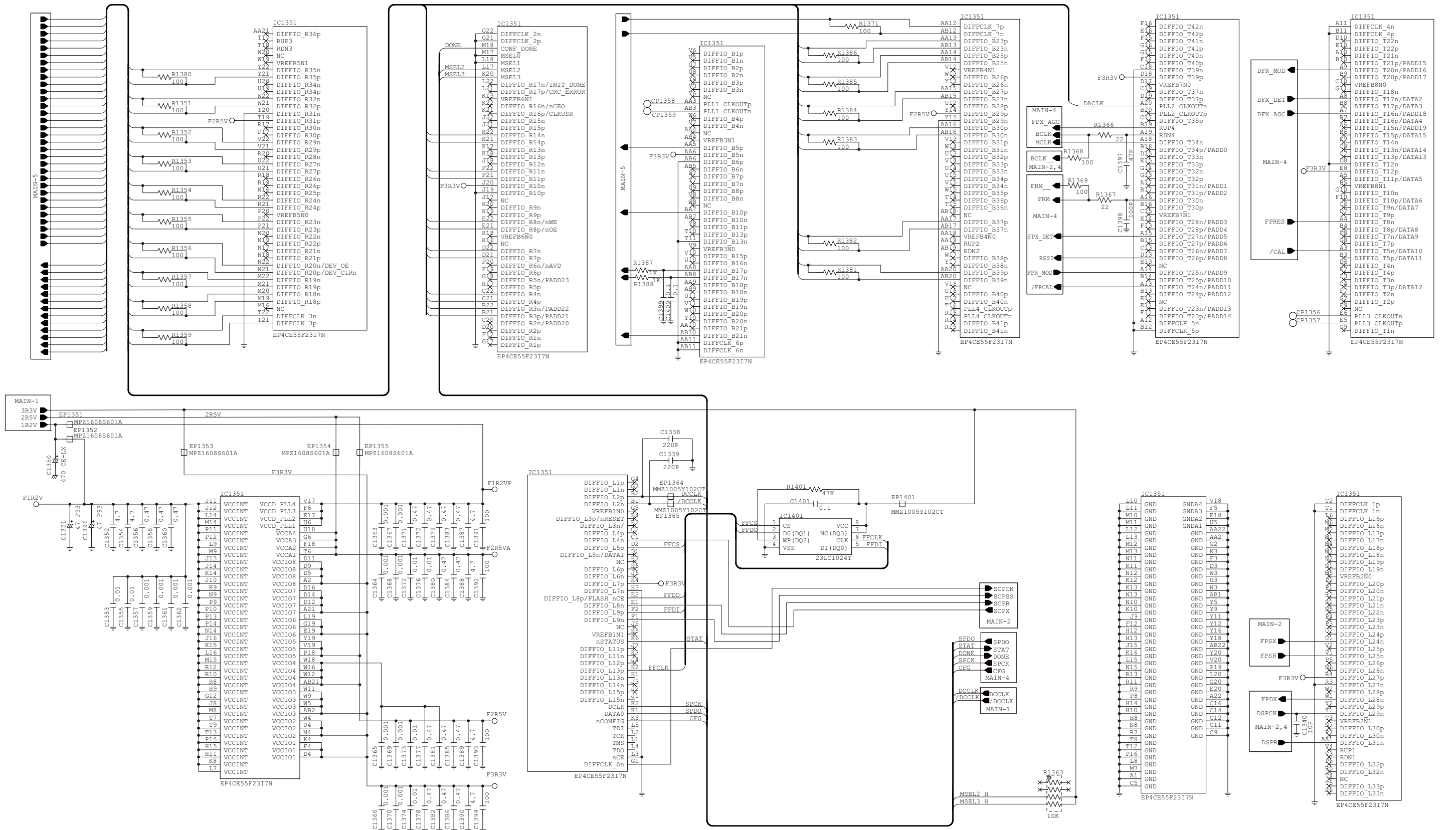

To upgrade quality, some components may be subject to change without notice.

RF UNIT

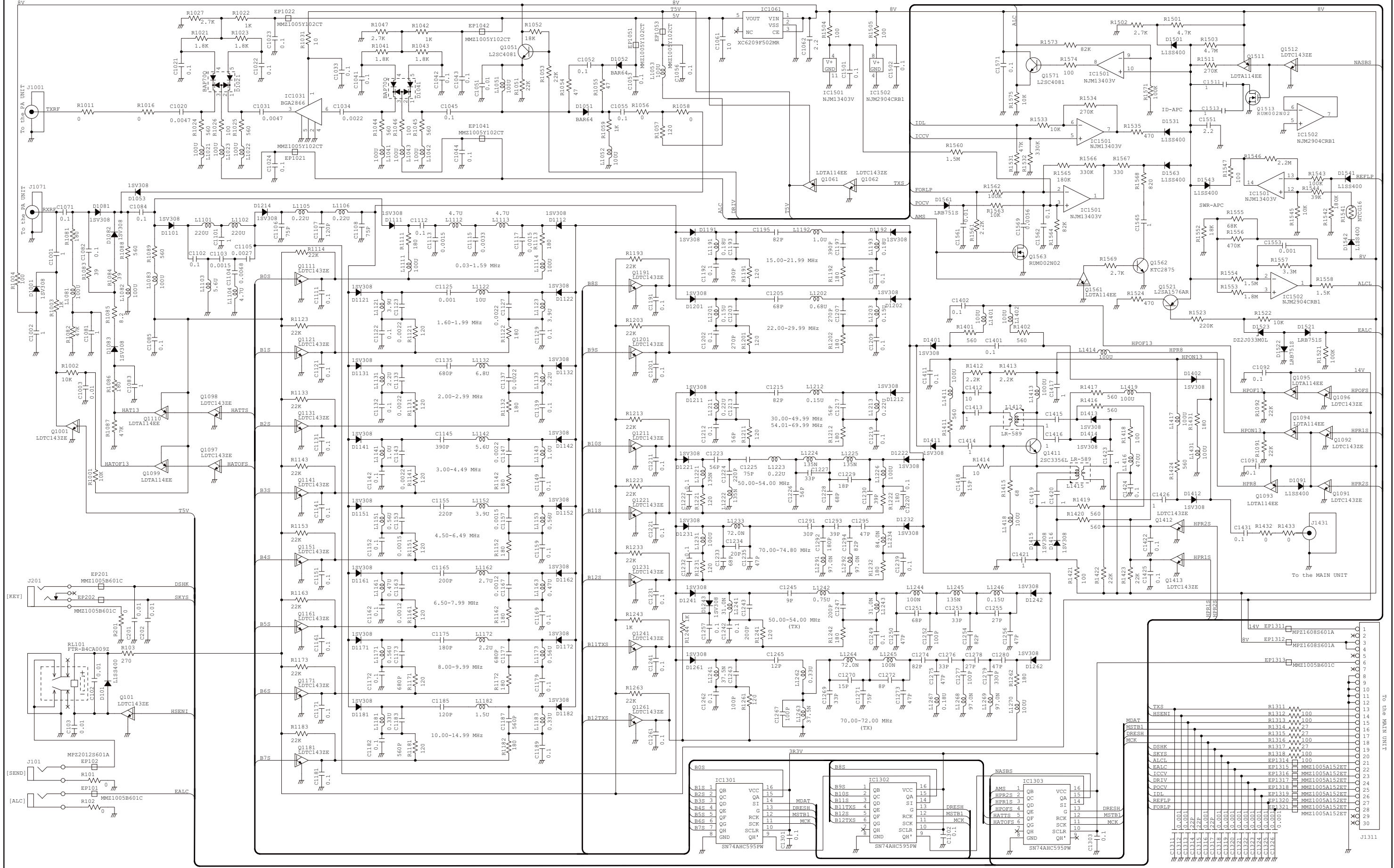

To upgrade quality, some components may be subject to change without notice.

TUNER UNIT (TUNER-1)

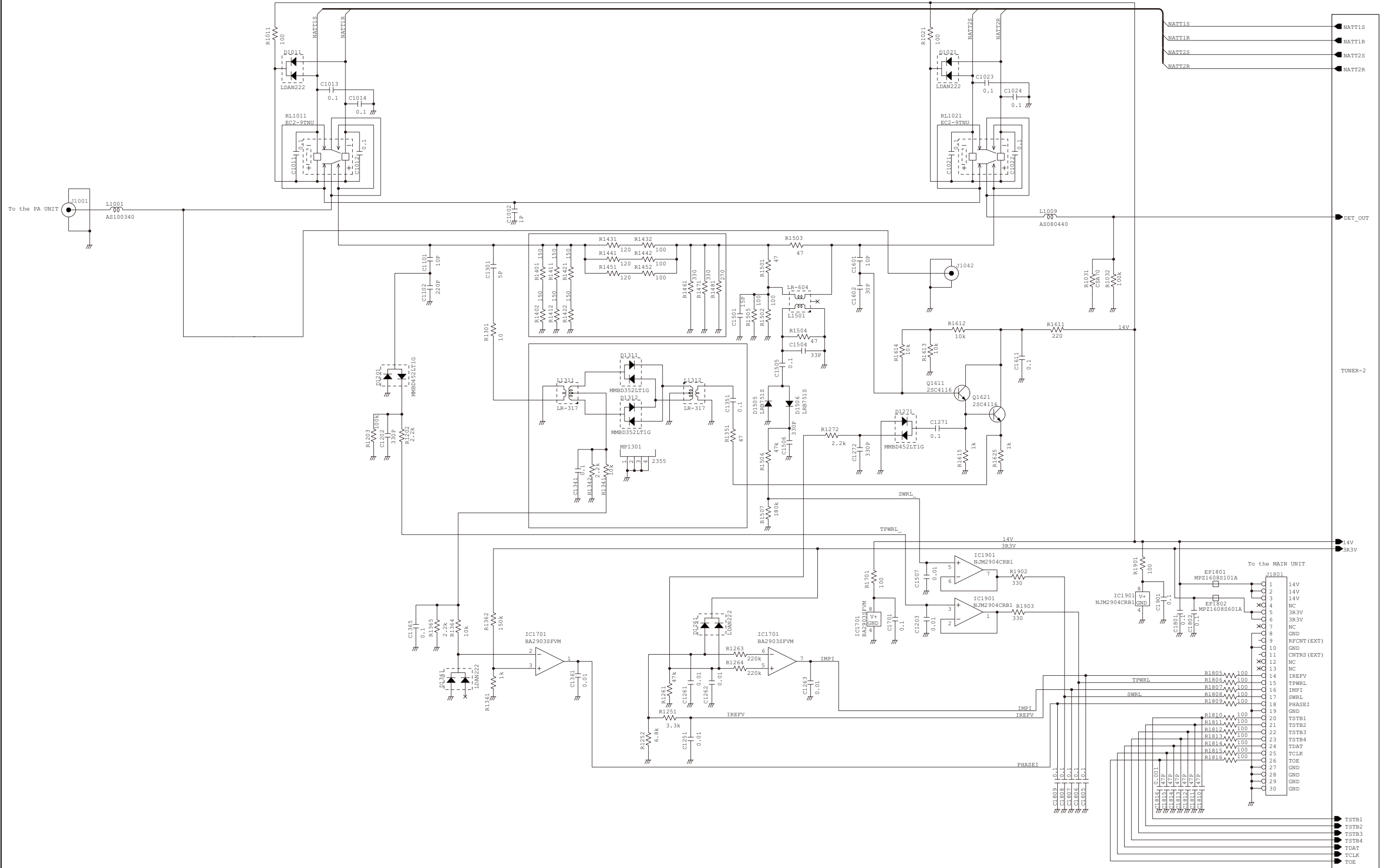

To upgrade quality, some components may be subject to change without notice.

TUNER UNIT (TUNER-2)

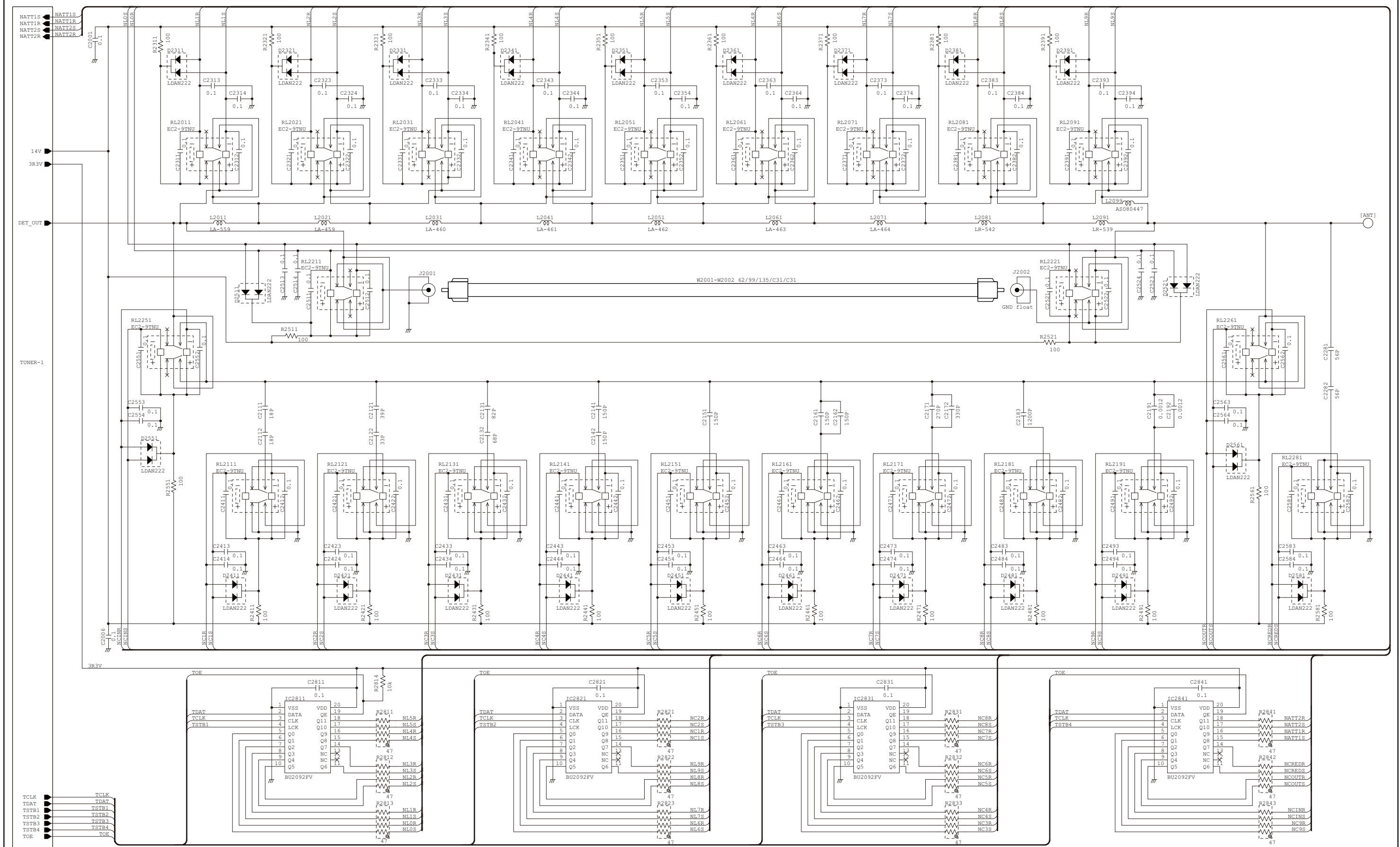

To upgrade quality, some components may be subject to change without notice.

A-7290-3EX-②  
Printed in Japan  
© 2015-2016 Icom Inc.

Icom Inc.

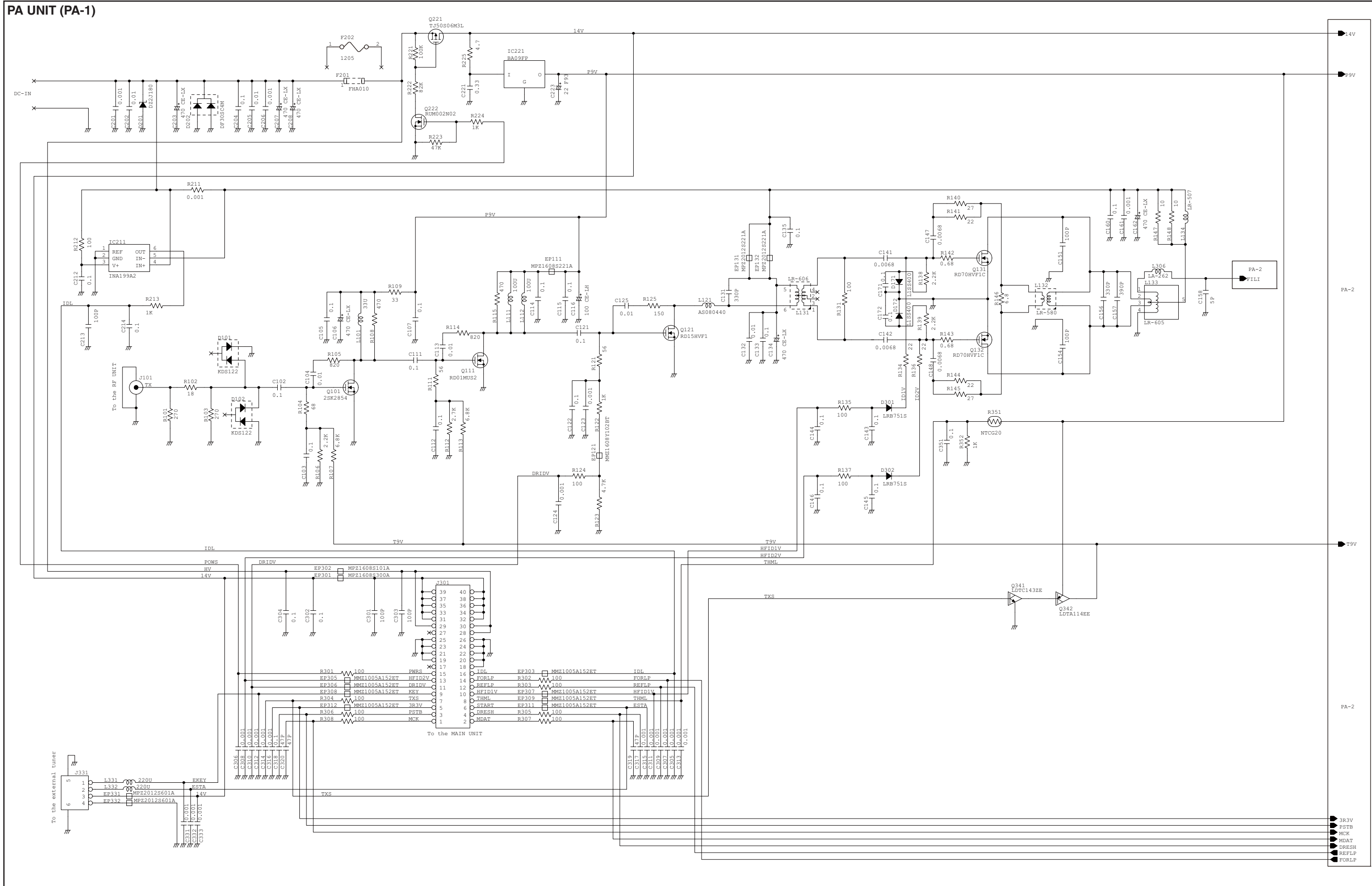

To upgrade quality, some components may be subject to change without notice.

A-7290-3EX-②  
Printed in Japan  
© 2015-2016 Icom Inc.

Icom Inc.



PA UNIT (PA-2)

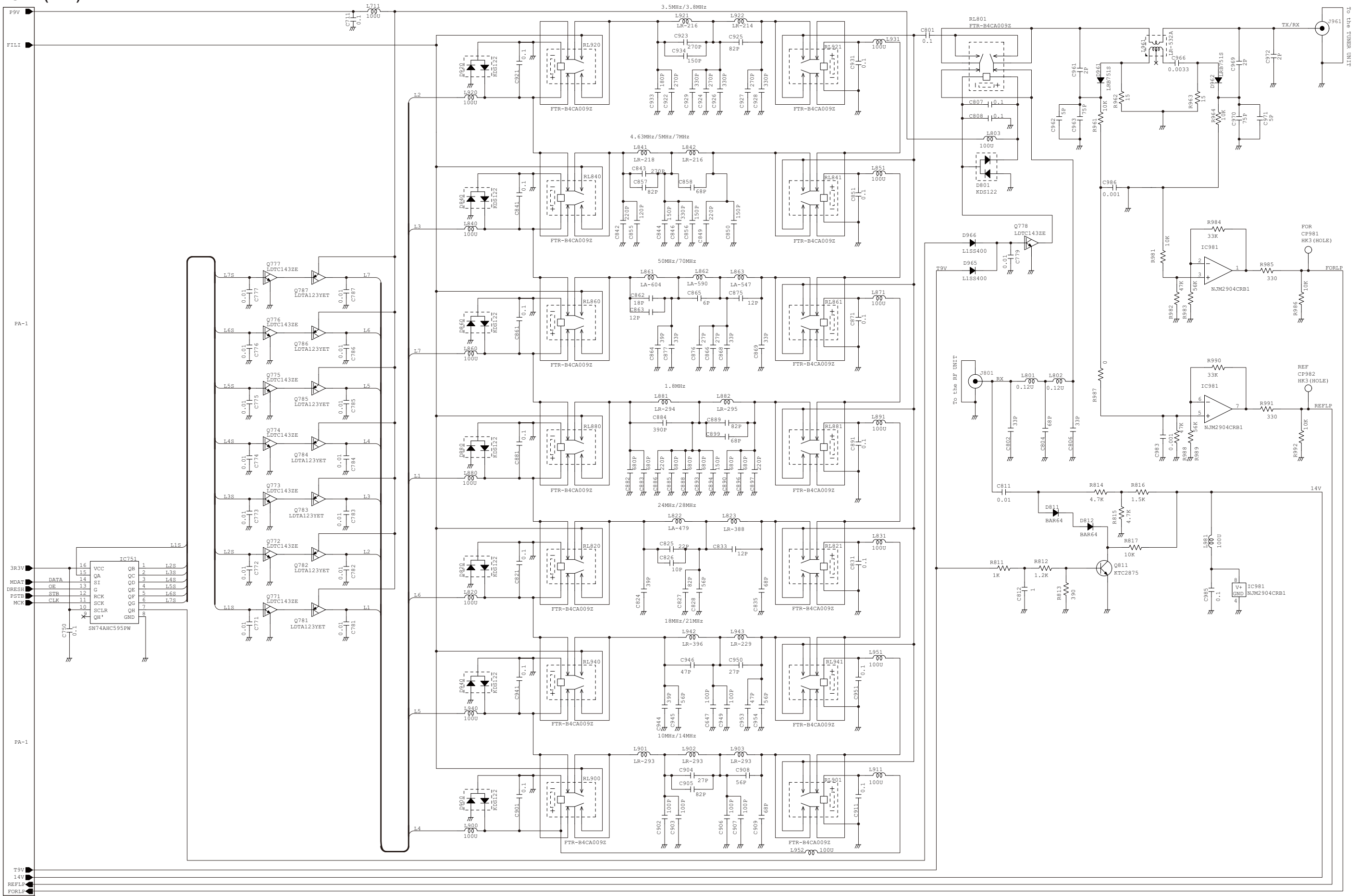

To upgrade quality, some components may be subject to change without notice.

A-7290-3EX-2  
Printed in Japan  
© 2015-2016 Icom Inc.

Icom Inc.