

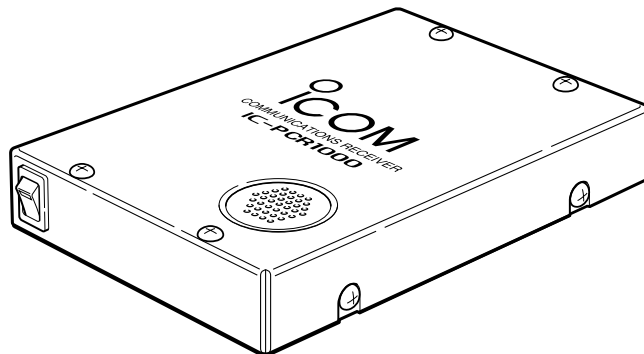

INSTRUCTION MANUAL

COMMUNICATIONS RECEIVER FOR COMPUTER **IC-PCR1000**

This device complies with Part 15 of the FCC Rules. Operation is subject to the following two conditions: (1) This device may not cause harmful interference, and (2) this device must accept any interference received, including interference that may cause undesired operation.



Icom Inc.

IMPORTANT

READ ALL INSTRUCTIONS and on-line help carefully and completely before using the receiver.

SAVE THIS INSTRUCTION MANUAL — This instruction manual contains important operating instructions for the **IC-PCR1000 COMMUNICATIONS RECEIVER FOR COMPUTER**.

USE antenna(s), such as a well-matched 50 Ω antenna and feedline. For radio communications, the antenna is of critical importance, along with sensitivity.

EXPLICIT DEFINITIONS

WORD	DEFINITION
⚠ WARNING	Personal injury, fire hazard or electric shock may occur.
CAUTION	Equipment damage may occur.
NOTE	If disregarded, inconvenience only. No risk of personal injury, fire or electric shock.

Icom, Icom Inc. and  are registered trademarks of Icom Incorporated (Japan) in the United States, United Kingdom, Germany, France, Spain, Russia and/or other countries.

FEATURES

•USER-SELECTABLE INTERFACE

Users can choose from 3 different operating screens depending on their ability level and preference.

•WIDE FREQUENCY RANGE, MULTI-MODE RECEIVE

The IC-PCR1000 has a wide frequency coverage from 0.5 MHz to 1300 MHz* with all mode receive capability.

*Some frequency ranges are restricted depending on version.

•IF SHIFT

The IF shift function is effective in SSB mode for reducing interference from nearby signals. It does so by electronically shifting the passband of the IF filter.

•REAL-TIME BANDSCOPE FUNCTION

The real-time bandscope function makes it easy to find busy frequencies and also easy to observe receive frequency band conditions. The maximum band width is ± 200 kHz.

•NOISE BLANKER •VSC (Voice Scan Control) FUNCTION
•S-METER SQUELCH •HIGH PERFORMANCE PLL CIRCUIT •A VARIETY OF TUNING STEPS •A VARIETY OF SCANS •DIGITAL AFC CIRCUIT



Versions of the IC-PCR1000 which display “CE” on the serial number seal, comply with the essential requirements of the 89/336/EEC directive for Electromagnetic Compatibility.

PRECAUTION

⚠ WARNING! NEVER connect the receiver to an AC outlet. This may pose a fire hazard or result in an electric shock.

NEVER connect other than the specified AC adapter to the receiver. This connection will ruin the receiver.

NEVER connect the receiver to a power source of more than 16 V DC such as a 24 V battery. This connection will ruin the receiver.

NEVER allow children to touch the receiver.

NEVER expose the receiver to rain, snow or any liquids.

DO NOT use or place the receiver in areas with temperatures below 0°C (+32°F) or above +50°C (+122°F) or, in areas subject to direct sunlight.

AVOID placing the receiver in excessively dusty environments.

AVOID the use of chemical agents such as benzine or alcohol when cleaning, as they damage the receiver surfaces.

Microsoft® and Windows® are registered trademarks of Microsoft Corporation in the U.S.A and other countries. Screen shots produced with permission from Microsoft Corporation. All other products or brands are registered trademarks or trademarks of their respective holders.

For U.S.A. only (FCC information)

CAUTION: Changes or modifications to this receiver, not expressly approved by Icom Inc., could void your authority to operate this receiver under FCC regulations.

Class B digital device users

This equipment has been tested and found to comply with the limits for a Class B digital device, pursuant to Part 15 of the FCC Rules. These limits are designed to provide reasonable protection against harmful interference in a residential installation. This equipment generates, uses and can radiate radio frequency energy and, if not installed and used in accordance with the instructions, may cause harmful interference to radio communications. However, there is no guarantee that interference will not occur in a particular installation. If this equipment does cause harmful interference to radio or television reception, which can be determined by turning the equipment off and on, the user is encouraged to try to correct the interference by one or more of the following measures:

- Reorient or relocate the receiving antenna.
- Increase the separation between the equipment and receiver.
- Connect the equipment into an outlet on a circuit different from that to which the receiver is connected.
- Consult the dealer or an experienced radio/TV technician for help.

For Canada only

Operation is subject to the following two conditions: (1) this device may not cause interference, and (2) this device must accept any interference, including interference that may cause undesired operation of the device.

SYSTEM REQUIREMENTS

- An RS-232C serial port (38400 bps or faster)
- Microsoft® Windows® 98/98SE/Me/2000/XP
- At least 10 MB of hard disk space
- 640 × 480 pixel display (800 × 600 pixel display recommended)

TABLE OF CONTENTS

IMPORTANT	i
EXPLICIT DEFINITIONS	i
FEATURES	i
PRECAUTION	ii
SYSTEM REQUIREMENTS	iii
TABLE OF CONTENTS	iii
1 INSTALLATION	1-7
■ Hardware installation	1
■ Antenna installation	2
■ Grounding	2
■ AF output level selection	3
■ TNC connection	4
■ Software installation	5
■ Uninstallation	6
■ Starting the IC-PCR1000	7
■ Serial port setting	7
2 PANEL DESCRIPTION	8-12
■ Component screen	8
■ Radio screen	12
■ Communications receiver screen	12
3 SPECIFICATIONS	13-14
4 SUPPLIED ACCESSORIES AND OPTIONS	15
■ Supplied accessories	15
■ Options	15

■ Hardware installation

Refer to the diagram below for connections.

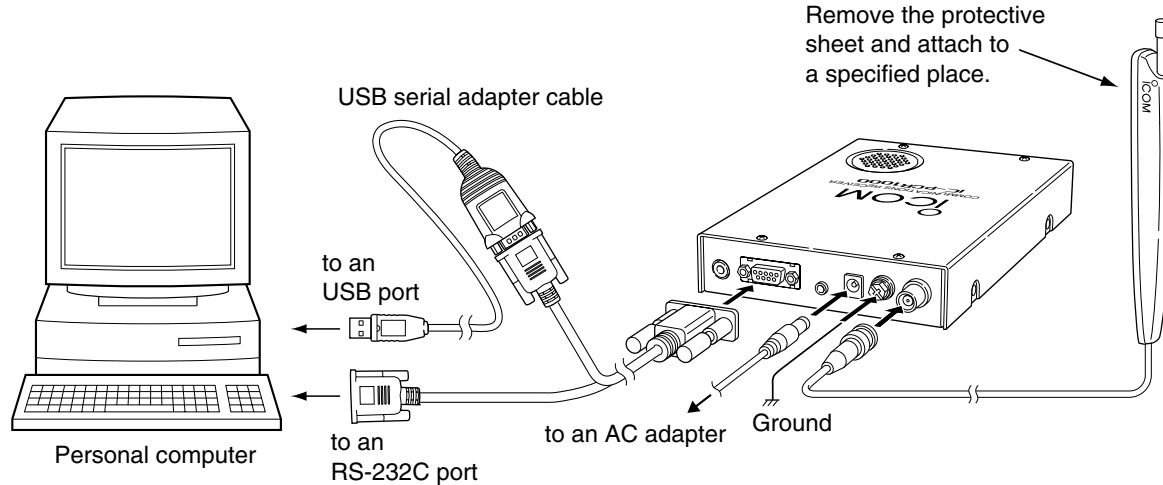

* When using the USB serial adapter cable, USB serial port can be used.
It is necessary to USB driver installation. The driver is supplied with the USB serial adapter cable.

1 INSTALLATION

■ Antenna installation

Antennas play a very important role in receiver operation. Connecting a poor quality antenna to the IC-PCR1000 will result in less than optimum performance.

Select antenna(s), such as a well-matched 50 Ω antenna and feedline. 1.5:1 of Voltage Standing Wave Ratio (VSWR) is recommended for a desired band. Of course, the antenna line should be a coaxial cable.

CAUTION: Protect your receiver from lightning by using a lightning arrestor.

NOTE: The supplied antenna is a simple plain antenna which may not obtain indicated specifications. To obtain maximum performance from the IC-PCR1000, you must purchase an external wide band antenna such as an optional Icom AH-7000 (25–1300 MHz), etc.

Contact your nearest Icom Dealer or Service Center for regarding optimum antenna locations.

The antenna connector type is BNC, so an adapter may be necessary to connect an optional antenna.

■ Grounding

WARNING: NEVER use a gas pipe or electrical conduit pipe for grounding.

To prevent accidents involving electricity and interference from computers, ground the receiver through the GROUND terminal on the rear panel.

For best results, connect a heavy gauge cable to a water pipe or long, earth-sunk copper rod. Make the distance between the [GND] terminal and ground as short as possible.

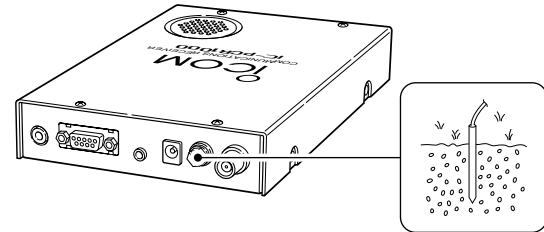

■ AF output level selection

The received audio can be input into your computer via the sound card.

Before inputting the received audio into the [LINE IN] connector (connector name depends on your sound card), the output level of the [EXT-SP] must be set properly. Perform as follows:

- ① Remove the 8 screws from the cover as shown below. Open the cover.

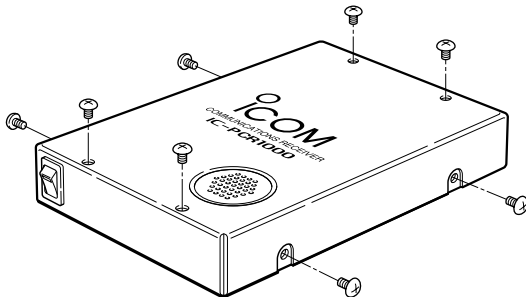

- ② Select the output level as shown below.
 - "SPEAKER" for internal speaker.
 - "PHONES" for PC sound card or headphones.

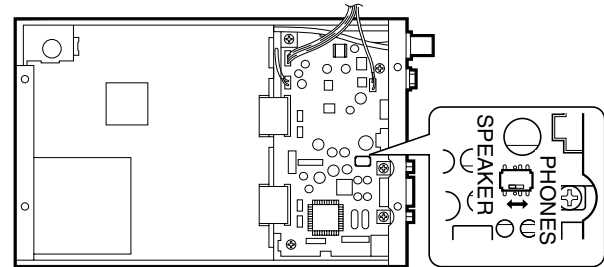

- ③ Replace the 8 screws and cover.
- ④ Connect an appropriate cable between IC-PCR1000 and PC.
 - Plug for [EXT-SP] is supplied with the receiver.

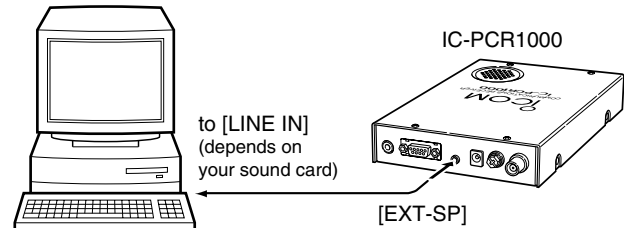

1 INSTALLATION

■ TNC connection

The IC-PCR1000 can receive 9600 bps packet communication (AFSK). Connect the TNC (Terminal Node Controller) as follows.

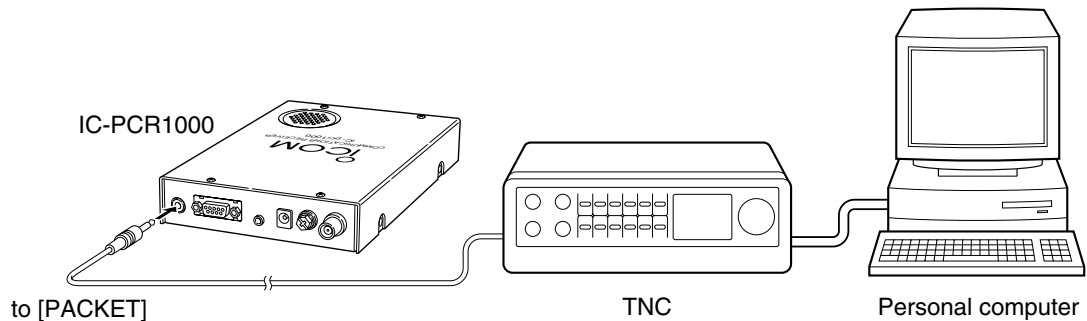

■ Software installation

When installing into a Windows XP or Windows 2000 environment, log on as the **administrator**.

- ① Quit all applications when windows is running.
- ② Insert the CD into the CD drive.
- ③ Select 'Run' from the [Start] menu.
- ④ Type the setup program name with full path name, then push the [Enter] key. (D:\SETUP.exe [Enter])
- ⑤ Click [OK].

* The following screens show Windows XP.



- The “InstallShield® Wizard” starts preparing the installation.

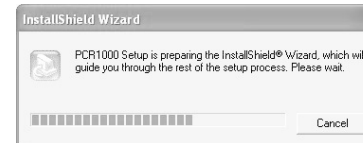

- ⑥ After the preparation, the following dialog is displayed. Click [Next>].
Installing starts.

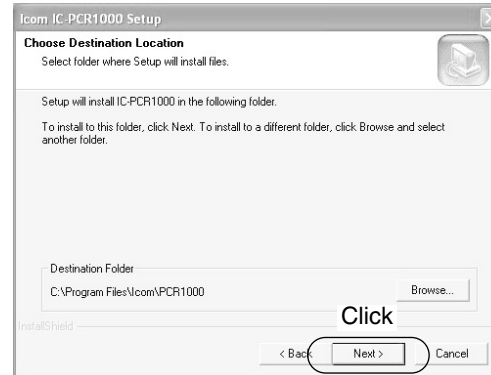

1 INSTALLATION

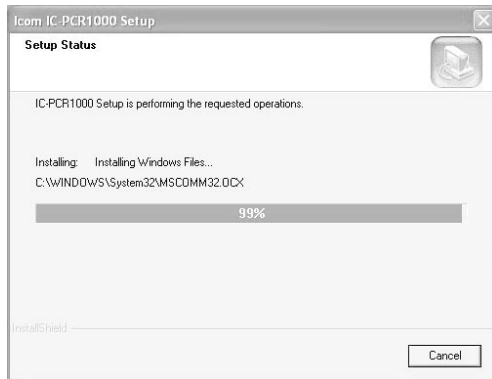

- ⑦ After the installation is completed, click [Finish].



- ⑧ Eject the CD.

■ Uninstallation

This section describes [IC-PCR1000] uninstallation.

◇ Windows XP

[Procedure]

- ① Click <Start> and select [Control Panel].
- ② Click [Add or Remove Programs] and select [ICOM IC-PCR1000] and click <Change/Remove>.
- ③ [IC-PCR1000] Uninstall Wizard starts automatically.
- ④ Click <Uninstall> and follow the prompts.

◇ Windows 98/98SE/Me/2000

[Procedure]

- ① Click <Start> and select [Control Panel] from the [Settings] menu.
- ② Double-click [Add or Remove Programs] and select [ICOM IC-PCR1000] and click <Change/Remove...>.
- ③ Follow the prompts.

■ Starting the IC-PCR1000

◇ Windows XP

- ① Before launching the program, make sure the IC-PCR1000 interface unit power is turned ON (the LED lights when power is on).
- ② Click <Start> and select [PCR1000] from the [All Programs] menu.
- ③ Select the [IC-PCR1000] program.

◇ Windows 98/98SE/Me/2000

- ① Before launching the program, make sure the IC-PCR1000 interface unit power is turned ON (the LED lights when power is on).
- ② Click <Start> and select [PCR1000] from the [Programs] menu.
- ③ Select the [PCR1000] program.

◇ On-line help information

See the on-line help for software usage.

- ① Click the [Contents] in the [Help] menu to bring up the on-line help.
- ② Click the desired information you want to know.

◇ Software update information

Software update information will be available at the Icom America home page:

<http://www.icomamerica.com/>

■ Serial port setting

Select the RS-232C serial port correctly if the title bar displays “COM port trouble?”.

- ① Before launching the program make sure the IC-PCR1000 interface unit power is turned on (the LED lights when power is on).
- ② Launch the IC-PCR1000 software.
- ③ Click the [POWER] button in the tool bar to temporarily pause the program.
- ④ Click the [PORT] button to bring up the [RS-232C PORT Number] dialog box.
- ⑤ Click the desired port COM number to choose it.
- ⑥ Click the [OK] button.

■ Component screen

See the on-line help for more information.

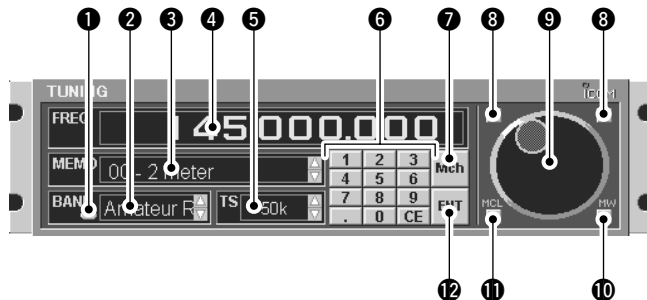

1 BANK (memory bank) button

Used to change the memory bank number indication and memory bank name indication when using the component screen.

2 BANK (memory bank) indicator

Indicates the memory bank (and its name if it has one) being received.

3 MEMO (memory) indicator

Indicates the memory channel (and its name if it has one) being received.

4 FREQ (frequency) indication

Indicates the receive frequency and data as it is being input such as memory channel numbers, etc.

5 TS (tuning step) indicator

This is the frequency increment used when selecting a frequency using the [Main dial] and when searching for signals using a scan function.

6 Numeral buttons ([0] to [9])

Used to input a receive frequency or memory channel directly.

7 Mch (memory channel) button

Used to set the numeral buttons for memory channel input.

8 Tuning step buttons

Used to change the tuning step.

9 Main dial

Used to select a receive frequency.

10 MW (memory write) button

Writes the current receive frequency into a memory channel.

11 MCL (memory clear) button

Used to clear the contents of unneeded memory channels.

12 ENT (enter) button

Used to set the numeral buttons for frequency input.

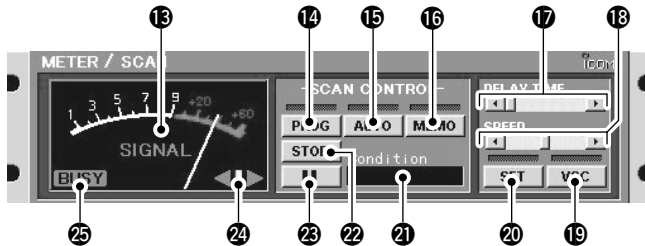

13 Signal meter

Indicates the receive signal strength. Also indicates the S-meter squelch receive level set via the [SQUELCH] scroll bar.

14 PROG (program scan) button

Used to start/stop program scan. The indicator lamp lights during scan and Program SCAN appears in the Condition indicator window.

15 AUTO (auto memory write scan) button

Used to start/stop auto memory write scan. The indicator lamp lights during scan and Auto MW SCAN appears in the Condition indicator window.

16 MEMO (memory scan) button

Used to start/stop any of the memory scans. The indicator lamp lights during scan and Memory SCAN appears in the Condition indicator window.

17 DELAY TIME scroll bar

This sets the period in which a scan pauses after receiving a signal. Moving the knob to the right increases the period; to the left decreases the period.

18 SPEED (scan speed) scroll bar

Sets the speed at which scans search through frequencies/memories for signals. Moving the knob to the right increases the speed; to the left decreases the speed.

19 VSC (Voice Scan Control) button

Turns the voice scan control function on and off. This function detects whether signals are modulated (contain voice or music components, etc.) or not.

20 SET button

Shows/hides the [Setting] dialog box used to adjust settings for scan functions, the band scope function and the automatic mode function.

21 Condition indicator window

Indicates the scan function operating condition. When scan temporarily pauses to receive a signal Busy Stop appears.

22 STOP button

Cancels scan operation.

23 II (scan pause) button

Used to pause/resume a scan. When a scan is paused, Pause appears in the Condition indicator window.

24 Center indicators

Indicate the tuning level when selecting the 6 kHz or 15 kHz IF filter in FM mode.

25 BUSY indicator

Appears when receiving a signal or when signal noise opens the squelch.

2 PANEL DESCRIPTION

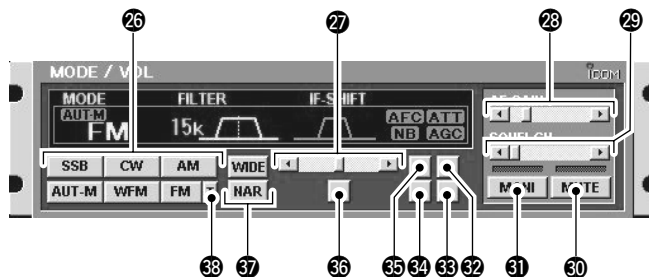

26 Receive mode buttons

Select a receive mode. Using the [AUT-M] button to select automatic mode also selects a receive mode.

27 IF-SHIFT (IF shift) scroll bar

Sets a signals passband position. Moving the knob to the right sets the passband higher, moving the knob to the left sets the passband lower.

28 AF (audio frequency) GAIN scroll bar

Adjusts the audio output.

29 SQUELCH scroll bar

Adjusts the squelch level.

30 MUTE button

Turns the mute function on and off. Used to temporarily mute audio output.

31 MONI (Monitor) button

Turns the monitor function on and off. The monitor function is used to temporarily open the squelch to listen to weak signals.

32 ATT (Attenuator) button

Turns the attenuator on and off.

33 AGC (Automatic Gain Control) button

Turns the AGC function on and off.

34 NB (Noise Blanker) button

Turns the noise blanker function on and off. The noise blanker is used to reduce pulse type noise.

35 AFC (Automatic Frequency Control) button

Turns the AFC function on and off. This function tracks the receive signal when drifting.

36 Center button

After moving a signals' passband position with the [IF-SHIFT] scroll bar, this button returns it to the center position.

37 FILTER (IF filter) buttons

Change the IF filter in use. The [WIDE] button selects a wider filter, the [NAR] button selects a narrower filter.

- Usable IF filters vary according to receive mode.

38 T (Tone squelch) button

Shows/hides the [TONE SQUELCH] dialog box for setting tone squelch tone frequencies.

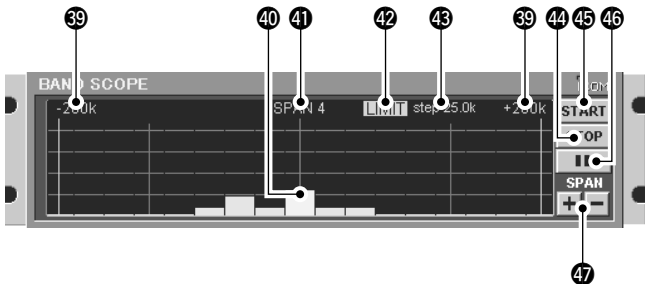

39 +200k/-200k (Max. frequency span value) indicators

Indicate the upper and lower observable frequency limits around a receive frequency.

In the diagram, the upper and lower limits are +200 kHz and -200 kHz.

40 Center frequency indicator

Indicates the center frequency of the frequency span; this is for the currently received frequency.

41 Frequency span indication

Indicates the frequency span selected with the [SPAN+/-] button.

42 LIMIT indicator

Indicates when the tuning step is greater than the automatic sweep step setting.

In the diagram, the tuning step is greater than the automatic sweep step setting and the tuning step (TS) and the sweep step width are not the same.

43 Sweep step indicator

Indicates band scope sweep step.

44 STOP button

Stops the band scope (sweep) function.

45 START button

Starts the band scope (sweep) function which is used to observe signal conditions around the receive frequency.

46 II (sweep pause) button

Pauses/resumes a band scope function sweep.

47 SPAN +/- buttons

Select one of four levels for the band scope frequency span.

2 PANEL DESCRIPTION

■ Radio screen

The radio screen shows 10 memory channel buttons and frequency readout, etc. like a typical stereo tuner—this provides the simplest operation for monitoring your most-listened-to stations, such as AM/FM broadcasting and TV, etc.

See the on-line help for the radio screen details.

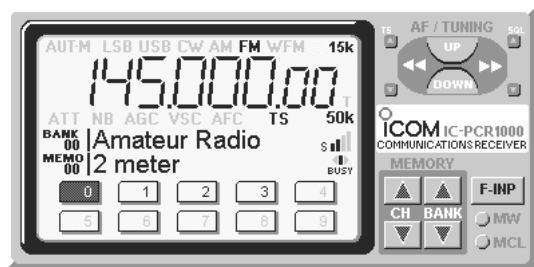

■ Communications receiver screen

The communications receiver screen shows S-meter (signal strength) level, a large frequency readout, keypad, etc.—what you would see on the front panel of a typical communications receiver.

See the on-line help for the communications receiver screen details.

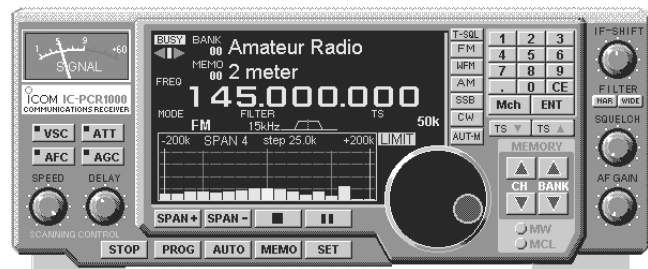

•Frequency coverage (MHz)

U.S.A. : 0.010000–823.999999*
 849.000001–868.999999
 894.000001–1300.000000

Europe : 0.010000–1300.000000*

*Specifications guaranteed 0.5–1300 MHz only.

- Receive system : Triple superheterodyne
- Mode : WFM, FM, AM, SSB, CW
- Frequency stability : ±3 ppm at 1300 MHz
 (0°C to +50°C; 32°F to +122°F)
- Frequency resolution : 1 Hz (minimum)
- Power supply requirement : 13.8 V DC ±15 % for receiver unit;
 or, supplied AC adapter
 (negative ground)
- Current drain (at 13.8 V DC)
 - Power ON (PC power OFF) : 0.1 A
 - Max. audio : 0.7 A
 - Standby (squelched) : 0.6 A
- Usable temp. range : 0°C to +50°C; +32°F to +122°F
- Intermediate frequencies
 - 1st : 266.7 MHz
 - 2nd : 10.7 MHz
 - 3rd : 450 kHz (except WFM)

•Receive sensitivity (typical)*:

Frequency (MHz)	SSB/CW (10 dB S/N)	AM (10 dB S/N)	FM (12 dB SINAD)	WFM (12 dB SINAD)
0.5–1.799999	0.56 μV	2.5 μV	—	—
1.8–27.99999	0.28 μV	1.4 μV		
28–29.99999		0.5 μV		
30–49.99999	0.35 μV	1.8 μV		
50–699.99999	0.2 μV	1.0 μV	0.32 μV	0.79 μV
700–1300	0.25 μV	1.3 μV	0.4 μV	1.0 μV

*When 230 kHz (for WFM), 15 kHz (for FM), 6 kHz (for AM) and 2.8 kHz (for SSB/CW) passband widths are selected.

•Squelch sensitivity (threshold):

Frequency (MHz)	SSB/CW	AM	FM	WFM
0.5–1.799999	14 μV	1.8 μV	—	—
1.8–27.99999	7.1 μV	0.89 μV		
28–29.99999			0.63 μV	
30–49.99999				
50–699.99999	5.6 μV	0.71 μV	0.5 μV	5.6 μV
700–1300	7.1 μV	0.89 μV	0.63 μV	7.1 μV

3 SPECIFICATIONS

- Selectivity
 - WFM : 230 kHz/−6 dB
 - WFM/FM/AM : 50 kHz/−6 dB
 - FM/AM : 15 kHz/−6 dB
 - FM/AM/SSB/CW : 6 kHz/−6 dB
 - AM/SSB/CW : 2.8* kHz/−6 dB

*Software indicates 3 kHz.
- IF shift range : More than ± 1.2 kHz
- Max. audio output : 200 mW
(at 10% distortion with an 8 Ω load)
- Antenna connector : BNC (50 Ω)
- RS-232C connector : D-sub 9-pin (female)
- Ext. speaker connector : 3-conductor 3.5 (d) mm ($1/8$ ")/
4–8 Ω
- Dimensions : 127.5(W) \times 30(H) \times 199(D) mm
(projections not included) 5(W) \times 1 $3/16$ (H) \times 7 $27/32$ (D) in
- Weight : approx. 1 kg; 2 lb 3 oz.

All stated specifications are subject to change without notice or obligation.

■ Supplied accessories

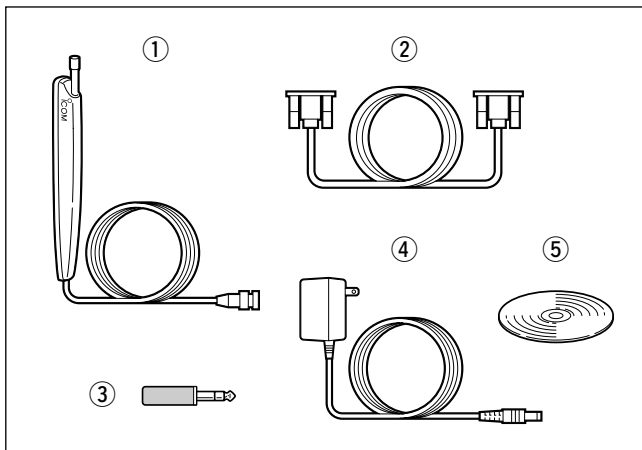

- ① Telescoping antenna 1
- ② RS-232C cable (OPC-743) 1
- ③ External speaker plug 1
- ④ AC adapter (BC-123A/E/V or BM-104E/V)* 1
- ⑤ CD 1

* For versions which do not come with an AC adapter, a DC power cable and 2 fuses (FGB 2 A) are supplied. An optional AC adapter (BC-123A/E/V or BM-104E/V) is also available.

■ Options

- AH-7000 SUPER WIDEBAND OMNIDIRECTIONAL ANTENNA
Frequency coverage
Receive : 25–1300 MHz
Transmit : 50, 144, 430, 900, 1200 MHz bands
Type of antenna : Discone
Weight : 1 kg

- UT-106 DSP UNIT
Provide AF DSP functions such as noise reduction and auto notch.

Count on us!

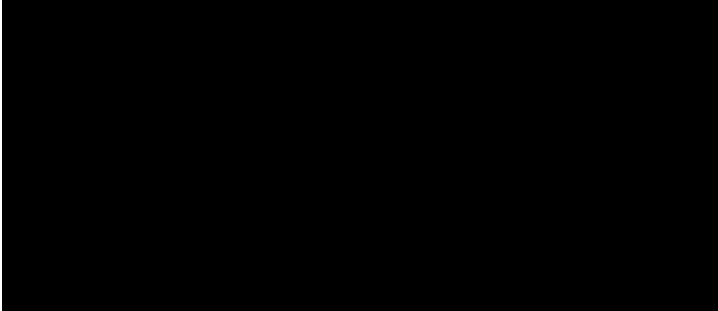

A-5456H-1EX-③
Printed in Japan
© 1997–2003 Icom Inc.

Icom Inc.
1-1-32 Kamiminami, Hirano-ku, Osaka 547-0003 Japan