



ADVANCED MANUAL

COMMUNICATIONS RECEIVER **IC-R15**

This manual describes instructions for advanced features and instructions.
See the BASIC MANUAL that comes with the receiver for precautions and basic operations.

- 1 BATTERY CHARGING
- 2 USING a microSD CARD
- 3 MEMORY OPERATION
- 4 SCAN OPERATION
- 5 FM RADIO OPERATION
- 6 RECORDER FUNCTION
- 7 SET MODE
- 8 OTHER FUNCTIONS
- 9 UPDATING THE FIRMWARE
- 10 OPTIONS

INTRODUCTION

Thank you for choosing this Icom product. This product is designed and built with Icom's state of the art technology and craftsmanship. With proper care, this product should provide you with years of trouble-free operation.

ABOUT THE CONSTRUCTION OF THE MANUAL

(As of March 2024)

You can use the following manuals to understand and operate this receiver.

① If necessary, you can download a glossary of HAM radio terms from the Icom website.

TIP: You can download each manual and guide from the Icom website:

<https://www.icomjapan.com/support/>

Enter "IC-R15" into the Search box on the site.

Basic manual (Comes with the receiver)

Instructions for the basic operations and precautions.

CI-V Reference Guide (PDF type)

Describes the control commands used in remote control operation (serial communication using CI-V).

Advanced manual (This manual)

- Battery charging
- Using a microSD card
- Memory operation
- Scan operation
- FM Radio operation
- Recorder function
- SET mode
- Other functions
- Updating the firmware
- Options

TRADEMARKS

Icom and the Icom logo are registered trademarks of Icom Incorporated (Japan) in Japan, the United States, the United Kingdom, Germany, France, Spain, Russia, Australia, New Zealand, and/or other countries.

Adobe, Acrobat, and Reader are either registered trademarks or trademarks of Adobe Systems Incorporated in the United States and/or other countries.

The Bluetooth word mark and logos are registered trademarks owned by the Bluetooth SIG, Inc. and any use of such marks by Icom Inc. is under license. Other trademarks and trade names are those of their respective owners.

Microsoft and Windows are trademarks of the Microsoft group of companies.

All other products or brands are registered trademarks or trademarks of their respective holders.

ENTERING AND EDITING TEXT

Controls used for text entry:

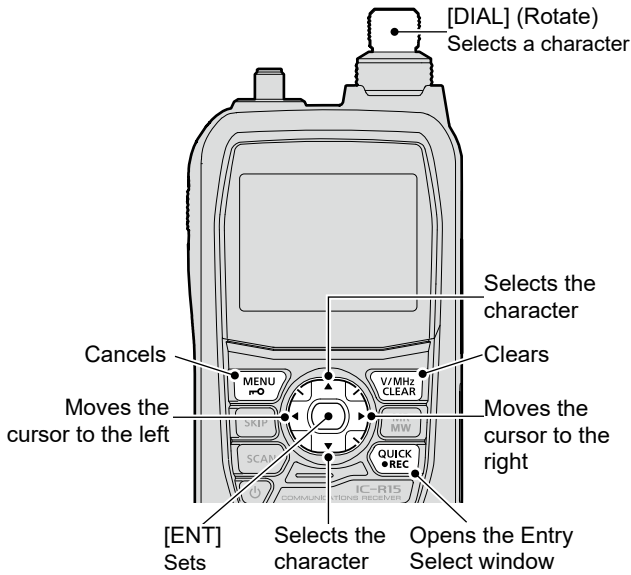

- To insert a text, move the cursor to a place to enter, and then rotate [DIAL] or push D-pad(↓).
- To clear a character, push [CLEAR].
- To consecutively clear characters, continuously hold down [CLEAR].

To change the character type:

1. When not selecting text, or an entered text is selected, push [QUICK].
2. Rotate [DIAL] to select the character type, and then push [ENT].

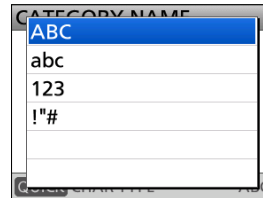

Character type	Selectable characters and symbols	Character conversion
ABC	A to Z, 0 to 9, (space)	A/a
abc	a to z, 0 to 9, (space)	A/a
123	0 to 9, (space)	-
!\"#	! \" \$ % & ' () * + , - . / : ; < = > ? @ [\\] ^ _ ` { } ~ (space)	-

TIP: When the character type is “ABC” or “abc,” and while entering a character, push [QUICK] to select upper case or lower case letters.

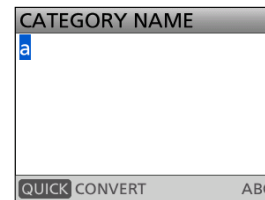

Push [QUICK]

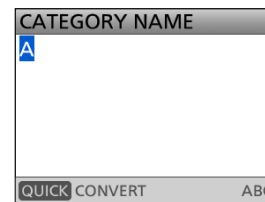

INTRODUCTION

USABLE CHARACTERS

The usable characters and symbols and the maximum characters differ, depending on the item. See the following list for details.

① The usable characters and symbols for each character type are described at the bottom of the list.

Category	Item	Character type	Maximum characters	Information
FM Radio Memory	Group Name	[ABC] [abc] [123] [!"#]	16	–
	Name	[ABC] [abc] [123] [!"#]	16	–
Memory CH	Category Name	[ABC] [abc] [123] [!"#]	16	–
	Group Name	[ABC] [abc] [123] [!"#]	16	–
	Name	[ABC] [abc] [123] [!"#]	16	–
Program Scan Edge	Name	[ABC] [abc] [123] [!"#]	16	–
Program Link	Program Link name	[ABC] [abc] [123] [!"#]	16	–
SD Card	Save Setting	[ABC] [abc] [123] [!"#]	20	Illegal characters: / : ; * < >
	Export	[ABC] [abc] [123] [!"#]	20	Illegal characters: / : ; * < >

[ABC]: A to Z, 0 to 9, (space)

[abc]: a to z, 0 to 9, (space)

[123]: 0 to 9, (space)

[!"#]: ! " # \$ % & ' () * + , - . / : ; < = > ? @ [\] ^ _ ` { | } ~ (space)

HOW TO ENTER TEXT

Example: Entering “2m Call” as a Memory name of channel 00 in group 06 (No Category).

[MENU] > MEMORY > **Memory CH**

1. Push [MENU].
2. Select “MEMORY” on the MENU screen.
3. Select “Memory CH.”
4. Select “(No Category).”
5. Select a channel group where the memory channel you want to edit is listed.
6. Select a Memory channel.

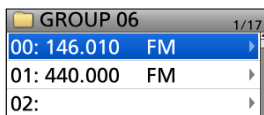
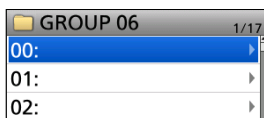

7. Push [QUICK].
8. Select “Edit.”

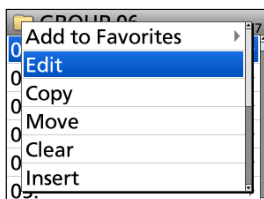

- The Edit screen is displayed.

9. Select “NAME.”

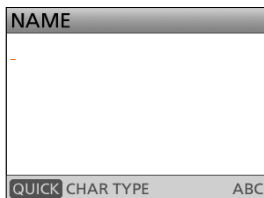
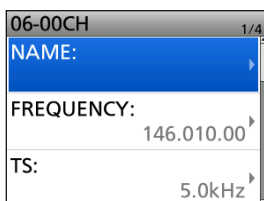

10. Push [QUICK].
11. Select the character type.

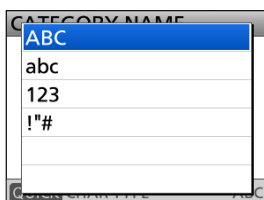

- ① To enter symbols, select “!\"#.”

12. Rotate [DIAL] to select a character, then push [ENT].

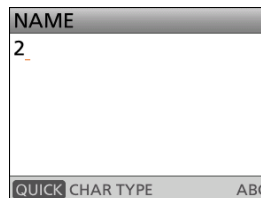

① Information

- To move the cursor forward, push D-pad(→).
- To move the cursor backward, push D-pad(←).
- To insert a character, move the cursor to a place to enter, then rotate [DIAL].
- To clear a character, push [CLEAR].
- To consecutively clear characters, continuously hold down [CLEAR].
- When the character type is “ABC” or “abc,” and while entering a character, push [QUICK] to select upper case or lower case letters.

13. Repeat steps 10 ~ 12 to enter a name, and then push [ENT].

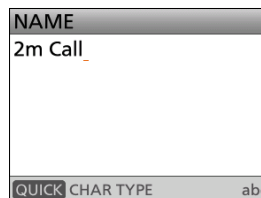

- Returns to the Edit screen and the entered name is displayed.

14. Select “<<Overwrite>>.”

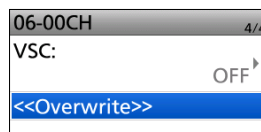

- A confirmation dialog is displayed.

15. Select “YES.”

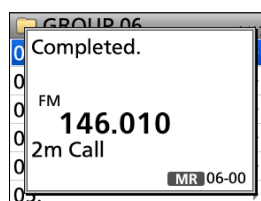
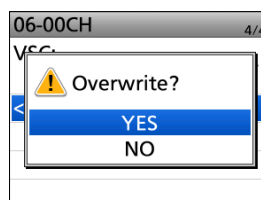

- The Memory name is overwritten.

INTRODUCTION

TIME SETTING

IC-R15 does not have the function to automatically set the time. We recommend you set the time from the SET mode before operating.

([MENU] > SET > Time Set > **Date/Time**)

① Set the time if the battery pack has been removed for more than a day.

① CS-R15 PROGRAMMING SOFTWARE (purchase separately) can automatically set the time.

Battery information	1-2
◇ Battery life	1-2
◇ Battery icon	1-2
◇ Capacity of the battery pack	1-2
Charging information	1-3
◇ Charging with a USB cable	1-3
Charging with the BC-223 optional rapid charger	1-4
About the optional battery case	1-5
◇ About the battery replacement	1-5
Specifications for the battery charger and battery pack	1-6
◇ BP-287 Li-ion BATTERY PACK	1-6
◇ BC-223 RAPID CHARGER	1-6

Battery information

◇ Battery life

The approximate battery life (operating time) is 13 hours under the following assumptions:

- External speaker (8 Ω load, at 10% distortion)

NOTE: BE SURE to replace the battery pack with a new one approximately five years after purchase, even if it still holds a charge. The material inside the battery cells will become weak after a period of time, even with little use.

The estimated number of times you can charge the pack is between 300 and 500. Even when the pack appears to be fully charged, the operating time of the receiver may become short when:





- Approximately five years have passed since the pack was manufactured.
- The pack has been repeatedly charged.

TIP: Keep the battery terminals clean. It's a good idea to clean them occasionally.

◇ Battery icon

The “” battery icon is displayed when the battery pack is attached to the receiver.

◇ Capacity of the battery pack

Icon	Battery Status
	The battery is being charged.
	The battery has sufficient capacity.
	The battery is exhausted a little.
 (green)	The battery is nearing exhaustion.
 (red)	The battery is almost fully exhausted. ① Immediately charge the battery pack. Otherwise, the icon will soon start blinking, “LOW BATTERY” will be displayed, and the receiver will automatically turn OFF.

- ① The battery icon for the BP-293 cannot display the capacity of the alkaline batteries. The battery icon always displays “,” and it does not reflect the true battery capacity.

Charging information

NOTE:

- Before using the receiver for the first time, the battery pack must be fully charged for optimum life and operation.
- **BE SURE** to turn OFF the receiver while charging. Otherwise, the attached battery pack cannot be charged.

- ① While charging, the charging icon “” and “Charging...” are displayed.
- ① The icon and “Charging...” disappear when the battery pack is fully charged.

◇ Charging with a USB cable

You can charge the battery pack with a USB cable (Type-C) while operating the receiver.

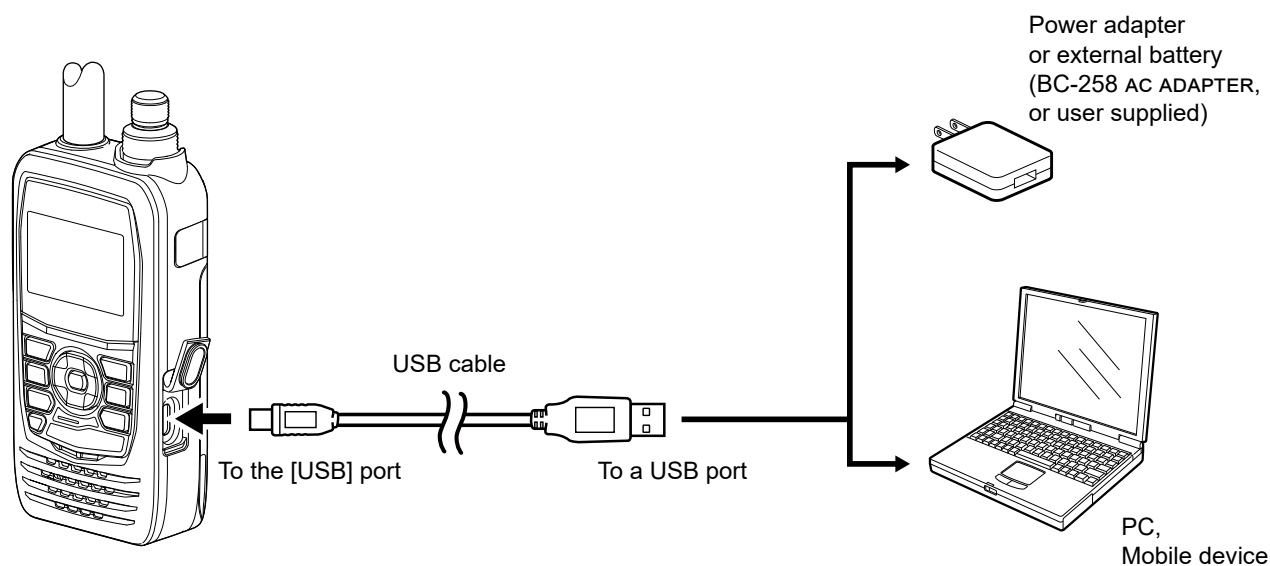

NOTE:

- **BE SURE** to attach the battery pack to the receiver.
- USB Power Delivery (USB PD) is not supported.
- You may not be able to charge:
 - Depending on your USB cable or power adapter.
 - When using a USB hub or connecting to a low output USB port.
- Charging time may differ, depending on the USB port.
- The S-meter may appear, or the noise may occur, due to the influence of the USB power supply's noise. In that case, unplug the USB cable to disconnect the receiver from the USB power supply.

TIP:

- When a USB cable is connected, the charging is stopped when the battery is fully charged. After that, the charging will resume when a certain amount of capacity is consumed while connecting the USB cable.
- You can change the operation when the receiver is connected to a PC through a USB cable. ([MENU] > SET > Function > **USB Connect**)

Charging with the BC-223 optional rapid charger

The optional BC-223 rapidly charges a battery pack.

① When about 90% of the battery capacity is charged, the BC-223 stops charging, and the charging indicator lights green. Therefore, the battery life will be a little shorter than when charging with the receiver.

Approximate charging time: 4 hours

① This is the time when the battery is exhausted, and charging with the receiver power off.

The following item is required.

- BC-123S (L-shaped type plug)
(A different type, or no power adapter is supplied, depending on the charger versions.)

CHARGING NOTE:

- **⚠ DANGER! NEVER** use a battery pack that is not manufactured or approved by Icom.
- **CAUTION: DO NOT** connect anything to the [USB] port on the side of the receiver when placing the receiver to the rapid charger. This may cause the charger's malfunction. If the charging indicator blinks orange, disconnect the power adapter from the charger, and then reconnect it.
- **BE SURE** to turn OFF the receiver. When the receiver power cannot be turned OFF because of battery exhaustion, detach the battery pack from the receiver. Then charge the battery pack by itself.
- The BC-223 rapid charger can only charge the BP-287 Li-ion battery pack. Other types of rechargeable batteries, Ni-Cd or Ni-MH, cannot be charged.
- If the charging indicator blinks orange, there may be a problem with the battery pack or charger. Contact your dealer if you have problems charging a new battery pack.

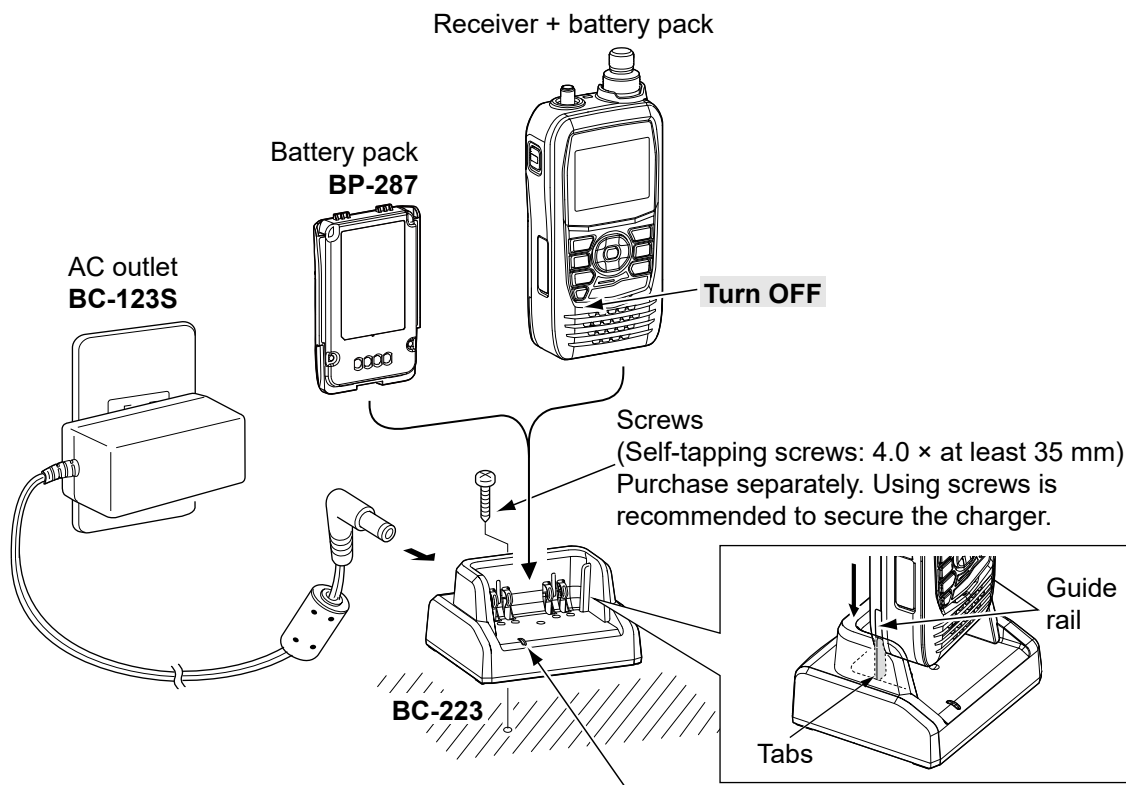

Charging indicator

- Lights orange: While charging
- Lights green: Charging is completed.
- Blinks orange: A charging error has occurred.

About the optional battery case

The BP-293 uses three AA (LR6) size alkaline batteries.

1. Remove the battery case top, as shown below.
2. Install three AA (LR6) size alkaline batteries.
 - ① Install only alkaline batteries.
 - ① BE SURE to observe the correct polarity.
3. Attach the battery case.

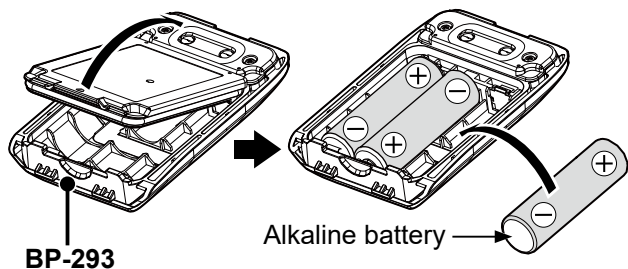

◇ About the battery replacement

When the alkaline batteries are almost exhausted, “LOW BATTERY” is displayed, and the battery icon blinks. After 10 seconds, the receiver power is automatically turned OFF. In that case, replace all 3 batteries with new alkaline batteries.

- ① The battery icon for the BP-293 cannot display the capacity of the alkaline batteries. The battery icon always displays “,” and it does not reflect the true battery capacity.

BATTERIES CAUTIONS:

- When installing batteries, confirm that they are all the same brand, type, and capacity. **DO NOT** mix new and old batteries.
- **DO NOT** incinerate used battery cells since the internal battery gas may cause them to rupture.
- **DO NOT** expose a detached battery case to water. If the battery case gets wet, **BE SURE** to wipe it dry before using it.
- **DO NOT** use batteries whose insulated covering is damaged.
- Keep the battery terminals clean. It’s a good idea to clean them occasionally.
- Remove the alkaline batteries when the battery case is not used. Otherwise, the installed alkaline batteries will be exhausted due to the built-in step-up converter.

TIP: The batteries may seem to have low capacity when used in low temperatures. Keep the batteries warm in this case.

Specifications for the battery charger and battery pack

◇ **BP-287 Li-ion BATTERY PACK**

- Voltage: 3.6 V
- Discharge Capacity: 3120 mAh (minimum)
- Usable temperature range: $-20^{\circ}\text{C} \sim +60^{\circ}\text{C}$, $-4^{\circ}\text{F} \sim +140^{\circ}\text{F}$
- Charging temperature range: $15^{\circ}\text{C} \sim 40^{\circ}\text{C}$, $59^{\circ}\text{F} \sim 104^{\circ}\text{F}$
- Storage temperature range: $-20^{\circ}\text{C} \sim +50^{\circ}\text{C}$, $-4^{\circ}\text{F} \sim +122^{\circ}\text{F}$ (within a month)
 $-20^{\circ}\text{C} \sim +40^{\circ}\text{C}$, $-4^{\circ}\text{F} \sim +104^{\circ}\text{F}$ (within 3 months)
 $-20^{\circ}\text{C} \sim +20^{\circ}\text{C}$, $-4^{\circ}\text{F} \sim +68^{\circ}\text{F}$ (within a year)
- Weight: Approximately 82 g, 2.9 oz
- Dimensions: 57.4 (W) × 84.5 (H) × 13.1 (D) mm, 2.3 (W) × 3.3 (H) × 0.5 (D) inches
(projections are not included)

◇ **BC-223 RAPID CHARGER**

- Power source requirement: 12 V ~ 16 V DC or the specified Icom power adapter
- Charging temperature range: $15^{\circ}\text{C} \sim 40^{\circ}\text{C}$, $59^{\circ}\text{F} \sim 104^{\circ}\text{F}$
- Weight: Approximately 120 g, 4.2 oz (without power adapter)
- Dimensions: 87.0 (W) × 47.3 (H) × 71 (D) mm, 3.4 (W) × 1.9 (H) × 2.8 (D) inches
(projections are not included)

Section 2 USING A microSD CARD

NOTE: See the Basic manual Section 6 for details on how to insert or remove a microSD card and precautions.

About data saved on a microSD card.....	2-2
Saving settings onto a microSD card	2-2
◇ Saving as a new file	2-2
Saving with a different file name.....	2-3
Loading the saved files on the microSD card.....	2-4
Backing up data saved on the microSD card onto a PC	2-5
◇ About the microSD card's folder.....	2-5
◇ Making a backup file on your PC.....	2-6
Importing or exporting a CSV format file	2-7
◇ Importing	2-7
◇ Exporting	2-8
About the SD Card mode	2-9
Check the free space and the recording time on the microSD card.....	2-10

About data saved on a microSD card

The following data can be saved onto the card:

- The receiver’s settings
- Voice recorder
- Captured screens
- Memory channel contents
- FM Radio memory
- Pictures for the Opening Picture setting

Saving settings onto a microSD card

The Memory channels and settings on the MENU screen can be saved on a microSD card. Saving data on the card enables you to easily restore the receiver to its previous configuration, even if you perform an All Reset.

You can save settings data as a new file, or you can overwrite a current file.

◇ Saving as a new file

[MENU] > SET > SD Card > **Save Setting**

1. Push [MENU].
2. Select “SD Card” in the “SET” menu.

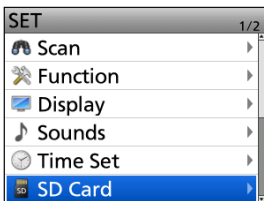

3. Select “Save Setting.”

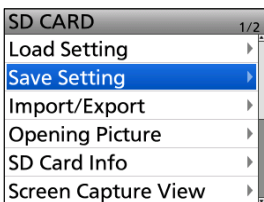

4. Select “<<New File>>.”

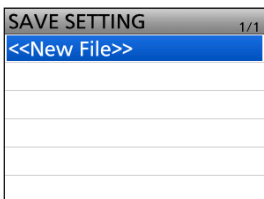

- The file is named in the following format:
SetYYYYMMDD_xx
(YYYY: Year, MM: Month, DD: Day, xx: file number).

① To change the file name, see page 2-3.

5. Push [ENT].



- The confirmation screen is displayed.

6. Select “YES.”

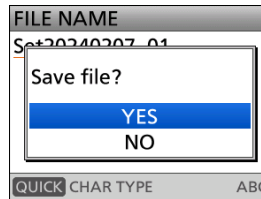

- While saving, a progress bar is displayed. When saving is completed, the SD CARD screen is displayed.

① To exit the MENU screen, push [MENU].

Overwriting a current file:

To overwrite data in a current file, select the file you want to overwrite in step 4 to the left.

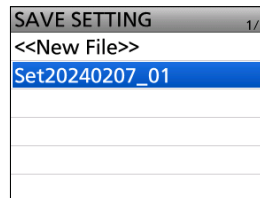

TIP: Data is saved in the “icf” file format. You can copy the icf data on a PC and edit it using the CS-R15 PROGRAMMING SOFTWARE (purchase separately).

Saving with a different file name

[MENU] > SET > SD Card > **Save Setting**

1. Push [MENU].
2. Select “SD Card” in the “SET” menu.

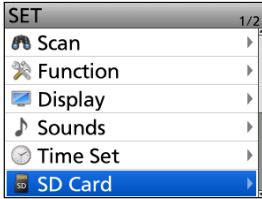

3. Select “Save Setting.”

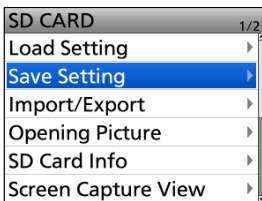

4. Select “<<New File>>.”

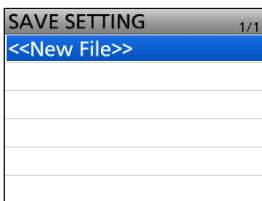

5. Hold down [CLEAR] to delete the characters.

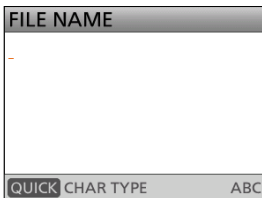

6. Enter a file name, and then push [ENT].

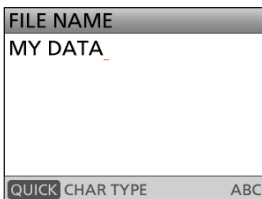

① See page ii on how to enter characters.

7. Select “YES.”

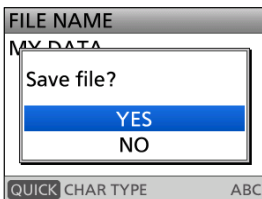

- While saving, a progress bar is displayed. When saving is completed, the SD CARD screen is displayed.

① To exit the MENU screen, push [MENU].

Loading the saved files on the microSD card

The saved Memory channels and settings on the MENU screen can be copied to the receiver. This makes it easy to copy Memory channels to another IC-R15 and operate with the same data.

NOTE: Saving the current data before loading other data into the receiver is recommended.

Example: Loading all the data in the "Set20240207_01" file

[MENU] > SET > SD Card > Load Setting

1. Push [MENU].
2. Select "SD Card" in the "SET" menu.

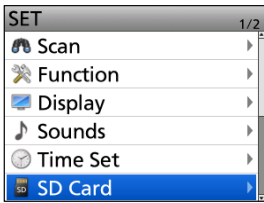

3. Select "Load Setting."

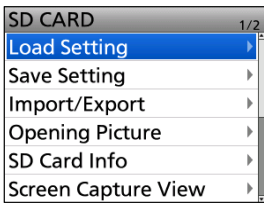

4. Select a data file to load into the receiver.

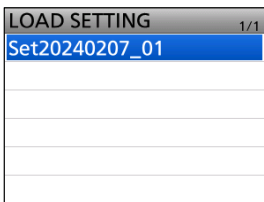

5. Select "YES."

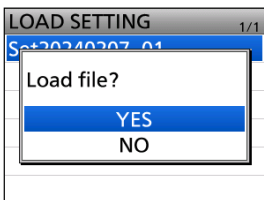

- Starts checking and loading the data file.
 - After loading, "COMPLETED!" is displayed.
6. Restart the receiver to operate with the new settings.

Backing up data saved on the microSD card onto a PC

A backup file enables easy restoration, even if the data on the microSD card is accidentally deleted.

◇ About the microSD card's folder

The folder in the microSD card contains the following:

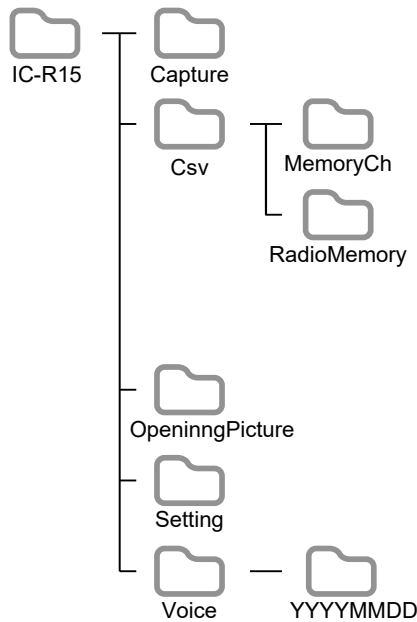

- **IC-R15 folder**
The folders created in the receiver are contained in this folder.
- **Capture folder**
The captured screen data in the “bmp” or “png” format.
- **Csv folder**
Memory channel, FM Radio memory.
- **MemoryCh folder**
The Memory channel contents in the “csv” format.
- **RadioMemory folder**
The FM Radio memory contents in the “csv” format.
- **OpeningPicture folder**
The pictures in the “bmp” format that are used for the Opening Picture setting.
- **Setting folder**
The receiver's setting data in the “icf” format.
- **Voice folder**
The recorded Voice recorder audio data folders.
- **YYYYMMDD folder**
The recorded Voice recorder audio data is saved in the “wav” format.

2 USING A microSD CARD

Backing up data saved on the microSD card onto a PC

◇ Making a backup file on your PC

Windows 11 is used for these instructions.

1. Insert the microSD card into the microSD card drive or a memory card reader on your PC.
2. Click the “Open folder to view files” option to access the card.

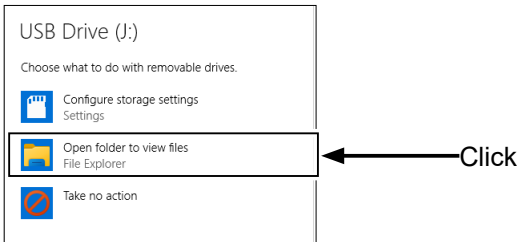

- 'IC-R15' folder is displayed.

3. Right-click “USB Drive.”
4. Click “📁.”

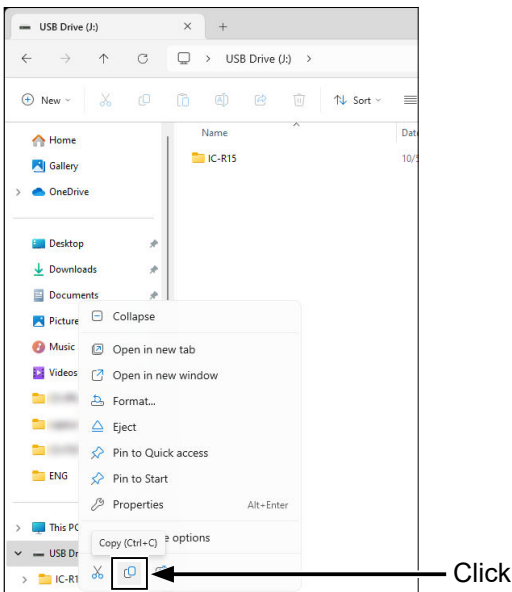

5. Open a folder to copy a backup file, then right-click, and then click “📁.”
 - Copies the card data onto your PC.(**Example:** Copying into the “Backup” folder on the C drive)

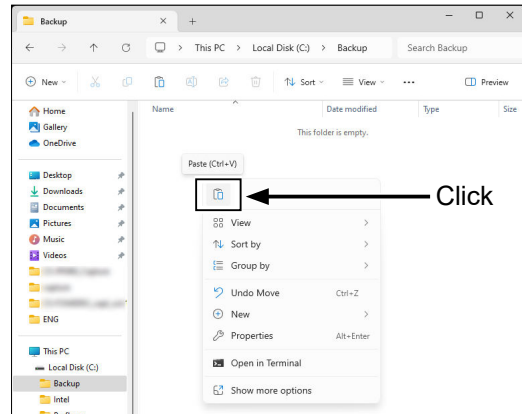

6. To remove the card, click the remove media icon (“🗑️” in the screenshot shown below) in the taskbar. Then, click “Eject USB Drive.”

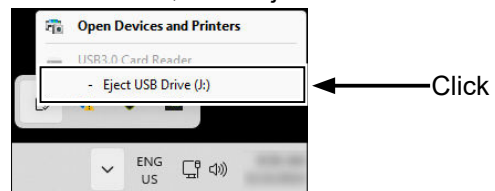

7. When “Safe To Remove Hardware” is displayed, remove the card.



TIP: When “USB Connect” is set to “SD Card Mode,” and the receiver is connected to the PC through a USB data cable, you can directly access the microSD card that is set in the receiver from the PC.
([MENU] > SET > Function > **USB Connect**)

Importing or exporting a CSV format file

Read this section before importing or exporting a Comma Separated Values (CSV) format file from the microSD card.

You can import or export the following data:

- Memory CH
- FM Radio Memory

◇ Importing

NOTE:

- Before importing, make a backup file of all the receiver's data to the card in case of data loss.
- The receiver cannot display files that have a file name 21 or more characters. If necessary, rename them using 21 characters or less. When exporting CSV format files using the CS-R15, **BE SURE** the names are 21 characters or less.

Example: Importing the memory channel.

[MENU] > SET > SD Card > Import/Export > **Import**

1. Push [MENU].
2. Select "SD Card" in the "SET" menu.

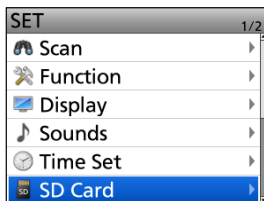

3. Select "Import/Export."



4. Select "Import."

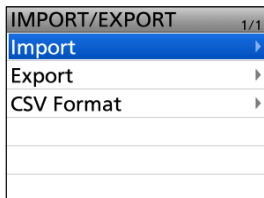

5. Select "Memory CH."

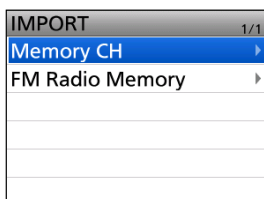

6. Select the CSV file to import.

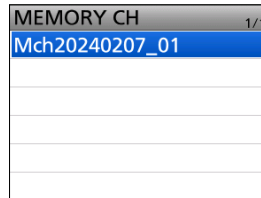

- The confirmation dialog is displayed.

7. Select "YES."

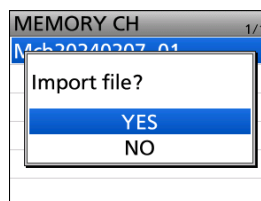

- Starts importing.
- After importing ends, "COMPLETED!" is displayed.

8. To complete importing, restart the receiver.

Importing or exporting a CSV format file

◇ **Exporting**

Saving as a new file:

Example: Exporting the memory channel.

[MENU] > SET > SD Card > Import/Export > **Export**

1. Push [MENU].
2. Select “SD Card” in the “SET” menu.

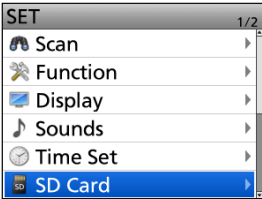

3. Select “Import/Export.”



4. Select “Export.”

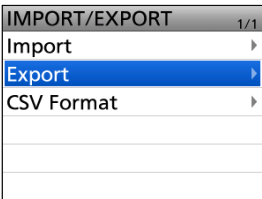

5. Select “Memory CH.”

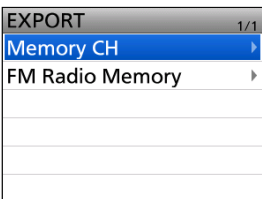

6. Select “<<New File>>.”

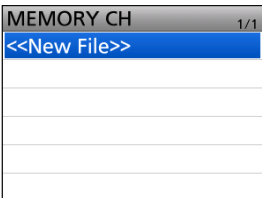

- Displays the FILE NAME screen.

① The file is named in the following format:

Mch*YYYYMMDD_xx
(YYYY: Year, MM: Month, DD: Day, xx: file number).

* When you select the other items, each file is named as shown below.

Memory CH: “Mch”
FM Radio Memory: “Radio”

① See page ii on how to enter characters.

7. Push [ENT].

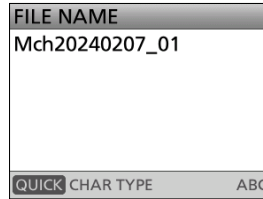

- The confirmation dialog is displayed.

8. Select “YES.”



- Exports the setting data.

① To exit the MENU screen, push [MENU].

Overwriting the current file:

When you overwrite data in a current file, select the file you want to overwrite in step 6.

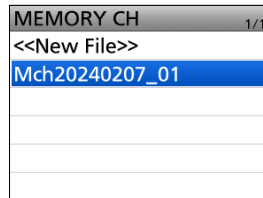

About the SD Card mode

When “USB connect” is set to “SD Card Mode,” and the receiver is connected to the PC through a USB data cable, you can transfer the files between the microSD card set in the receiver and a PC. You can back up the setting data and recording data saved on the microSD card to a PC, and save the firmware data to the microSD card without inserting or removing it.

[MENU] > SET > Function > **USB Connect**

1. Connect the receiver to a PC using a USB cable.
2. Push [MENU].
3. Select “Function” in the “SET” menu.
4. Select “USB Connect.”

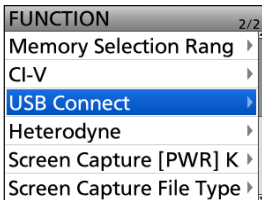

5. Select “SD Card Mode.”

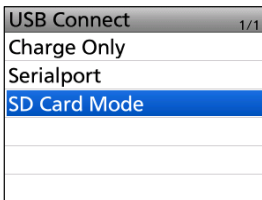

- The confirmation dialog is displayed.

6. Select “YES.”

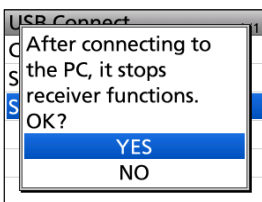

NOTE: Before connecting the receiver in the SD Card mode to a PC with a USB cable, a microSD card must be inserted.

① If the microSD card is not inserted, insert it with the receiver turned OFF, and then reconnect the USB cable.

TIP: In the SD Card mode, the receiver works not as a receiver but as a data storage device. It temporarily stops some functions as follows:

- Stops recording
- Disconnects a Bluetooth device
- Disables the Auto Power OFF function

To exit the SD Card mode

① This instruction manual is based on Windows 11.

1. Click “” in the task tray.
2. Click “Eject Device.”
3. After “Safe to Remove Hardware” is displayed, remove the USB cable from the PC.

Check the free space and the recording time on the microSD card

[MENU] > SET > SD Card > **SD Card Info**

1. Push [MENU].
2. Select "SD Card" in the "SET" menu.
3. Select "SD Card Info."

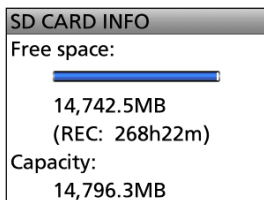
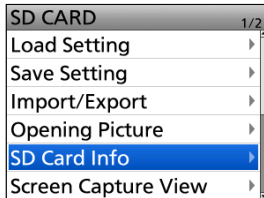

- The free space and the recording time on the microSD card are displayed.
- ① To exit the MENU screen, push [MENU].

General description	3-2
◇ Memory channel content	3-2
MEMORY screen	3-2
◇ Tree view of the MEMORY screen	3-2
◇ Viewing the Memory channel contents	3-3
Selecting a Memory channel	3-3
Entering Memory channel contents	3-4
◇ Entering into a selected channel	3-4
◇ Overwriting a selected channel	3-5
Copying Memory content to the VFO	3-6
Copying Memory contents to another Memory channel	3-7
Moving the Memory contents to another channel in a different category or group	3-8
Inserting a blank channel	3-9
Entering a category/group/memory name	3-10
Selecting a memory name display	3-11
Clearing a Memory contents	3-12
About the Category	3-13
◇ Entering a selected category	3-13
◇ Deleting a category	3-14
◇ Category icon list	3-14
FM Radio memory	3-15
◇ Using the FM Radio Memory	3-15
◇ Adding an FM Radio memory	3-15
◇ Deleting an FM Radio memory	3-17
◇ Editing an FM radio memory	3-18
◇ Rearranging the display order of the FM Radio memories	3-19

General description

The Memory mode enables you to quickly select often-used frequencies, modes, and other parameters. While operating in the Memory mode, you can temporarily change the operating frequency, mode, and so on without overwriting the memory channel contents.

Group	Memory channel	Descriptions
00 to 99	00 to 99	Regular memory channels. Up to 2000 channels can be separately stored in the 100 memory channel groups.

Memory channel content

The following information can be entered into the Memory channels:

- Name
- Operating frequency
- Tuning step
- Operating mode
- Duplex direction (DUP+/DUP-)
- Frequency offset
- Scan skip setting
- AF filter
- Favorite
- Subaudible tone encoder, tone squelch, or DTCS squelch ON/OFF*
- Subaudible tone frequency, tone squelch frequency, or DTCS code with polarity*
- VSC*

* For only FM/FM-N.

NOTE: Memory content may be accidentally cleared by static electricity, electric transients, and other causes. In addition, it may be cleared by a malfunction or during repairs. Therefore, we recommend that you backup the Memory content or save it onto a microSD card* or a PC.

*User supplied

① The CS-R15 PROGRAMMING SOFTWARE can also be used to backup your memory content. See its instruction manual for details.

MEMORY screen

On the MEMORY screen, you can easily manage the Memory channel content.

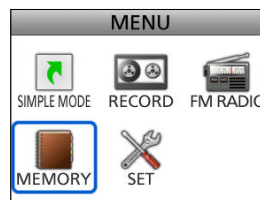

Tree view of the MEMORY screen

(Example)

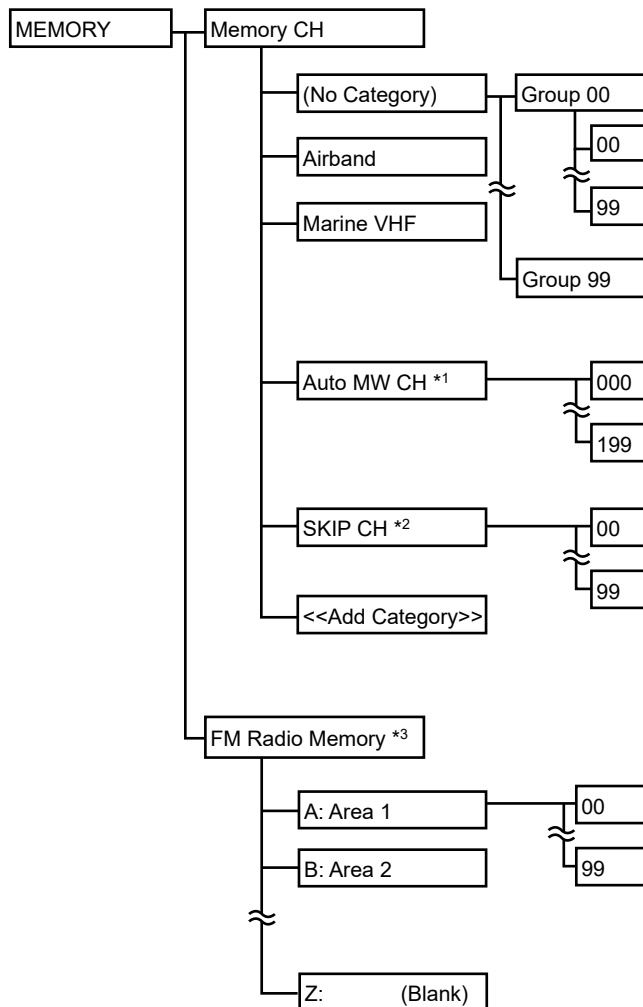

*1 Automatically writes when a signal is received.

*2 Skips the set frequency during a scan. While a VFO scan is paused and if you want to skip the frequency, push [SKIP] and select "Add to SKIP MR Group" to set the frequency as the Skip channel.

*3 See page 3-15 for details.

3 MEMORY OPERATION

MEMORY screen

◇ Viewing the Memory channel contents

You can view the Memory channel contents on the MEMORY screen.

Example: Viewing the contents of Channel 00 of Group 00 in the Airband category.

[MENU] > MEMORY > **Memory CH**

1. Push [MENU].
2. Select "MEMORY" on the MENU screen.
3. Select "Memory CH."

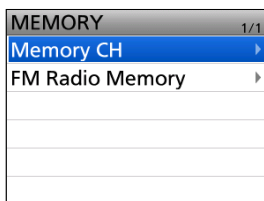

4. Select "Airband."

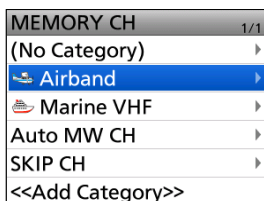

5. Select Group "00."

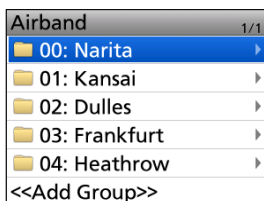

6. Select Channel "00."

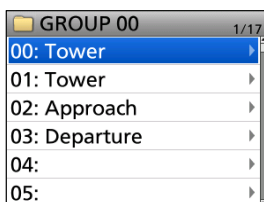

- Channel contents are displayed.
- ① Rotate [DIAL] to scroll the screen.
- ① To exit the MENU screen, push [MENU].

TIP: Editing the Memory channel contents

In step 6 above, push [QUICK] and select "Edit" to edit the selected Memory channel contents.

Selecting a Memory channel

In the Memory mode, you can select the Memory channels by rotating [DIAL].

The memory contents on the screen may differ, depending on the presetting.

1. Push [MR] to enter the Memory mode.
 - ① For only the USA version, pushing [MR] each time selects the Memory and Weather Channel modes.
2. Rotate [DIAL] to select a Memory channel.

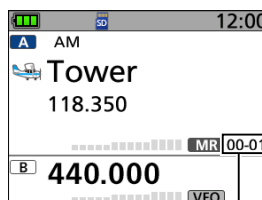
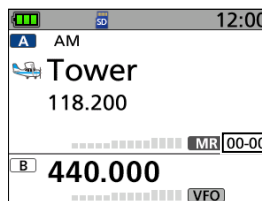

Memory group number and channel number

- ① Blank channels are not selected.
- ① To select a Memory Group, push [QUICK] and select "Select Category/Group."

TIP: To sequentially select a channel in a different group

1. Push [QUICK].
2. Select "Memory Selection Range."

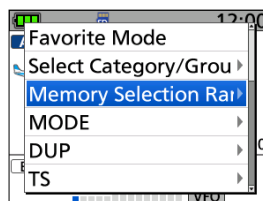

3. Select "All Groups."

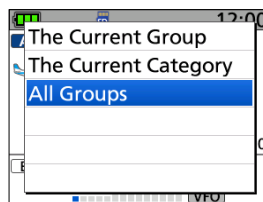

Entering Memory channel contents

After selecting a frequency in the VFO mode, you can enter it into a selected channel or an automatically selected blank channel.

◇ Entering into a selected channel

Example: Entering 146.030 MHz/FM mode into Channel 02 in Group 06 (No Category).

1. Push [V/MHz] to enter the VFO mode.
2. Rotate [DIAL] to set a frequency to 146.030 MHz.



3. Hold down [MW] for 1 second.
 - A short and a long beep sound.
4. Select “Write to New CH.”

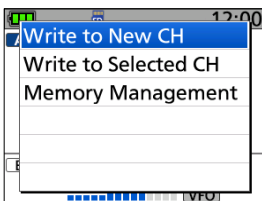

5. Push [QUICK].
6. Select “Select Category/Group.”

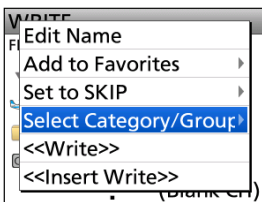

7. Select “(No Category).”

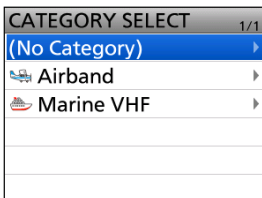

8. Select Group “06.”

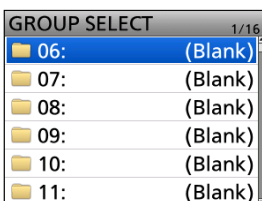

9. Rotate [DIAL] to select Channel “02.”

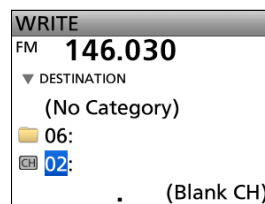

10. Push [ENT].
 - The confirmation dialog is displayed.
11. Select “YES.”

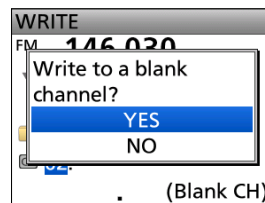

- Beeps sound and the Memory contents are briefly displayed, then returns to the VFO mode.

TIP: In step 6, you can select the following options.

- **Edit Name:** Displays the Memory name edit screen. (p. 3-10)
- **Add to Favorites** Displays the Favorites setting items.
- **Set to SKIP:** Displays the SKIP setting items.
- **Select Category/Group:** Displays the CATEGORY SELECT screen.
- **<<Write>>:** Enters into the selected Memory channel.
- **<<Insert Write>>:** Inserts a Memory channel above the selected channel.

3 MEMORY OPERATION

Entering Memory channel contents

◇ Overwriting a selected channel

You can write a frequency into a pre-entered channel.

Example: Entering 146.330 MHz/FM mode into Channel 03 of Group 01 in the Airband category.

1. Push [MR] to enter the Memory mode.
① For the USA version, pushing [MR] each time selects the Memory and Weather Channel modes.
2. Rotate [DIAL] to select Channel 03 in Group 01.



① To select a Category, push [QUICK] and select "Select Category/Group."

3. Push [V/MHz] to enter the VFO mode.
4. Rotate [DIAL] to set the frequency to 146.330 MHz.



5. Hold down [MW] for 1 second.
 - A short and a long beep sound.
6. Select "Write to Selected CH."

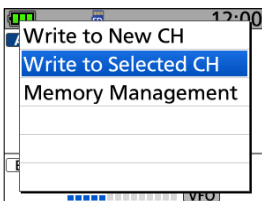

7. Push [MR].

8. Select "YES."

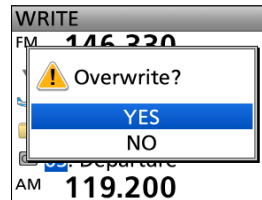

- Beeps sound and the Memory contents are briefly displayed, then returns to the VFO mode.

Copying Memory content to the VFO

It is convenient when you want to operate on a channel frequency near a Memory channel.

Example: Copying Memory Channel 00 of Group 00 in the Airband category to the VFO.

1. Push [MR] to enter the Memory mode.
 - ① For the USA version, pushing [MR] each time selects the Memory and Weather Channel modes.
2. Rotate [DIAL] to select Channel 00 in Group 00.

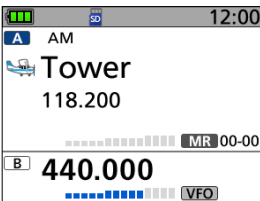

① To select a Memory Group, push [QUICK] and select "Select Category/Group."

3. Hold down [MW] for 1 second.
 - A short and a long beep sound.
4. Select "Copy to VFO."

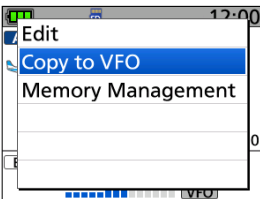

5. Select "YES."

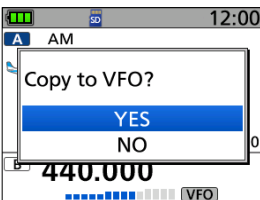

- Beeps sound and the selected Memory contents are copied to the VFO, then returns to the VFO mode.

Copying Memory contents to another Memory channel

You can copy the memory content to another Memory channel.

Example: Copying Channel 01 in Group 00 to Channel 06 in Group 00.

[MENU] > MEMORY > **Memory CH**

1. Push [MENU].
2. Select "MEMORY."
3. Select "Memory CH."
4. Select "Airband."
5. Select Group "00."
6. Select Channel "01."

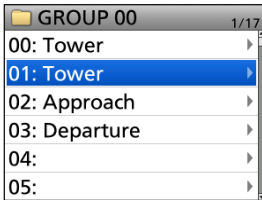

ⓘ **DO NOT** push [ENT].

7. Push [QUICK].
8. Select "Copy."

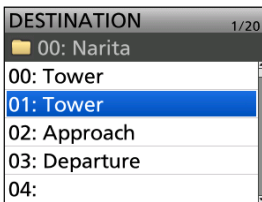
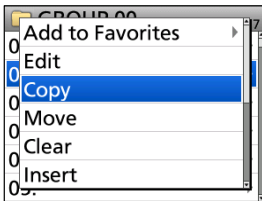

9. Select the destination channel.

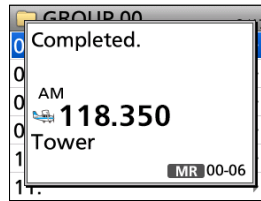
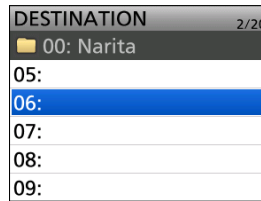

- Beeps sound, and the contents are copied to the destination channel.
- ⓘ If the selected channel is not blank, a confirmation dialog is displayed. When you select "YES," the Memory contents are overwritten.

TIP: To copy the channel to a different category or group

In step 6, while "DESTINATION" is displayed, push [QUICK] and select "Select Category/Group."

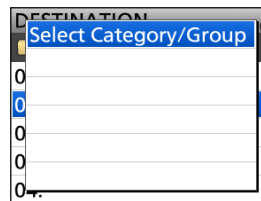

- The CATEGORY SELECT screen is displayed.

Moving the Memory contents to another channel in a different category or group

You can move the memory content to another Memory channel in a different category or group.

Example: Moving Channel 01 of Group 00 in the Airband category to Channel 00 of Group 02 in the same category.

[MENU] > MEMORY > Memory CH

1. Push [MENU].
2. Select "MEMORY."
3. Select "Memory CH."
4. Select "Airband."
5. Select Group "00."
6. Select Channel "01."

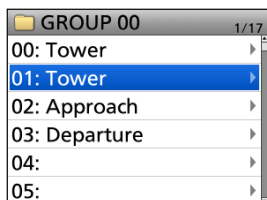

Ⓜ DO NOT push [ENT].

7. Push [QUICK].
8. Select "Move."

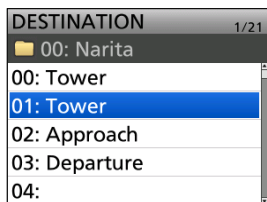
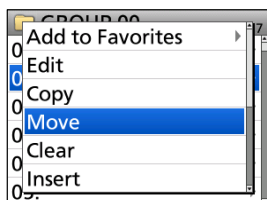

9. Push [QUICK].
10. Select "Select Category/Group."

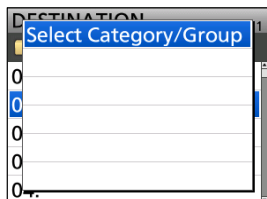

11. Select the destination category.

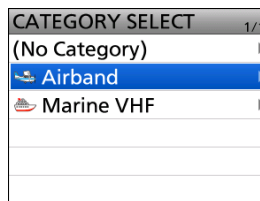

12. Select the destination group.

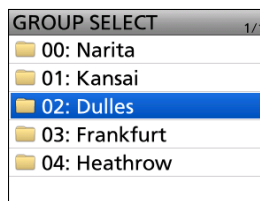

13. Select the destination channel.

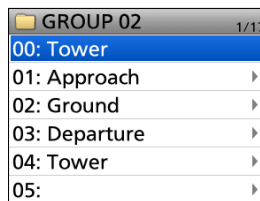
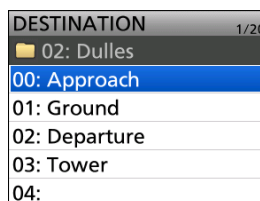

- Beeps sound, and the contents are moved to the destination channel.

Ⓜ Channels other than the one that you moved will move up.

TIP: To rearrange the display order in the selected group
In step 8, while "DESTINATION" is displayed, go to step 13.

Inserting a blank channel

You can insert a blank channel between 2 Memory channels. This function is convenient to organize your memory channels.

Example: Inserting a blank channel between Channel 00 and 01 of Group 00 in the Airband category.

[MENU] > MEMORY > **Memory CH**

1. Push [MENU].
2. Select "MEMORY."
3. Select "Memory CH."
4. Select "Airband."
5. Select Group "00."
6. Select Channel "01."

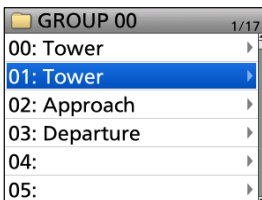

7. Push [QUICK].
8. Select "Insert."

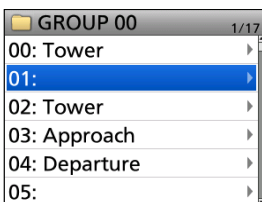
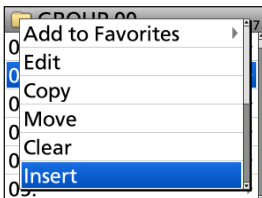

- Beeps sound, a blank channel is inserted above the selected channel.

① If you select channel 99 in step 6, a confirmation dialog is displayed. When you select "YES," channel 99 is deleted.

Entering a category/group/memory name

You can assign a name of up to 16 characters to each channel group (00 ~ 99) and memory channel.

Example: Entering “Tower” as a Memory name to Channel 00 of Group 00 in the Airband category.

[MENU] > MEMORY > **Memory CH**

1. Push [MENU].
2. Select “MEMORY.”
3. Select “Memory CH.”
4. Select “Airband.”
5. Select Group “00.”
6. Select Channel “00.”
- ① **DO NOT** push [ENT].
7. Push [QUICK].
8. Select “Edit.”

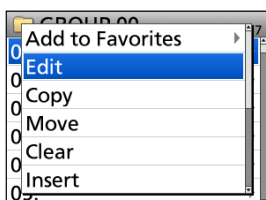

9. Select “NAME.”

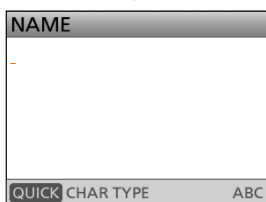
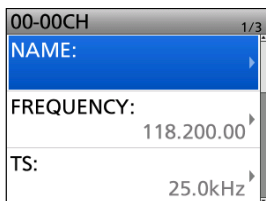

10. Enter a name.

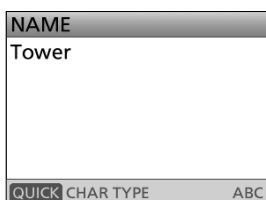

① See page iv on how to enter characters.

11. After entering, push [ENT].

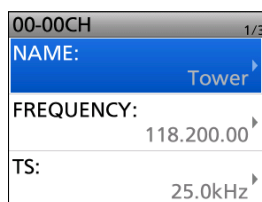

12. Select “<<Overwrite>>.”

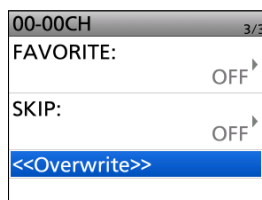

13. Select “YES.”

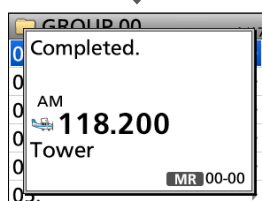
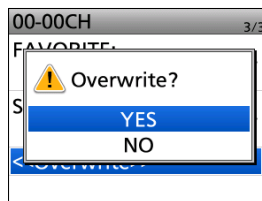

- Beeps sound, then returns to the Memory channel screen.

TIP: To enter a category name or group name

On the Category or Group list screen, select a category or group and push [QUICK], then select “Edit Category Name” or “Edit Group Name.”

Example: Edit Category Name

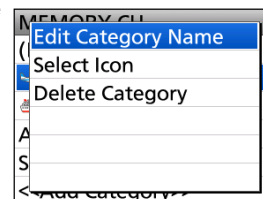

- The Category Name edit screen or Group Name edit screen is displayed.

Selecting a memory name display

While in the memory mode, the entered memory name can be displayed in different styles. You can select a display type.

Example: Selecting “Name” in the Dual band display.

[MENU] > SET > Display > **Display Type**

1. Push [MENU].
2. Select “SET.”
3. Select “Display.”

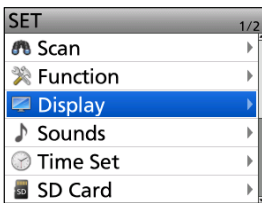

4. Select “Display Type.”

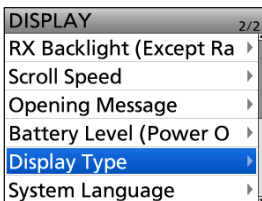

5. Select “Name.”

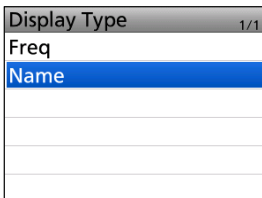

- **Freq:**
Displays the large font sized frequency and small font sized Memory name.

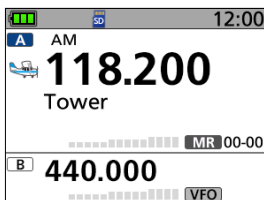

- **Name:**
Displays the large font sized Memory name and small font sized frequency.

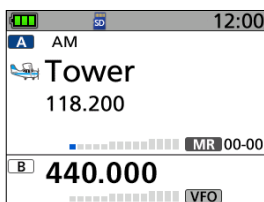

Clearing a Memory contents

Contents of entered memories can be cleared (erased), if desired.

① The cleared channel becomes a blank channel.

NOTE: Cleared memory channel contents cannot be restored.

Example: Clearing channel 01 of group 00 in the Airband category.

[MENU] > MEMORY > Memory CH

1. Push [MENU].
2. Select "MEMORY."
3. Select "Memory CH."
4. Select "Airband."
5. Select Group "00."
6. Select Channel "01."

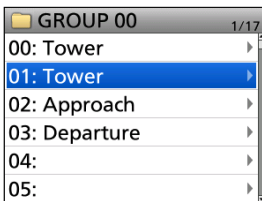

① **DO NOT** push [ENT].

7. Push [QUICK].
8. Select "Clear."

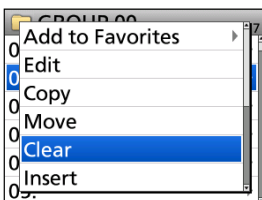

9. Select "YES."

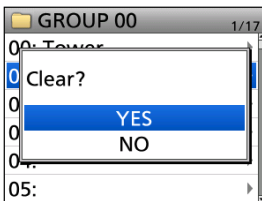

• Beeps sound, and the contents are cleared.

TIP: To Delete a memory channel
In step 8, select "Delete (next CH moves up)."

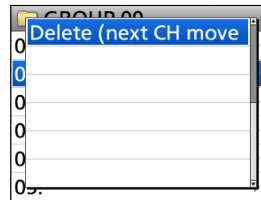

• The selected channel is deleted.

About the Category

You can add or delete a category.

◇ Entering a selected category

Example: Entering the “Railway” category

Step 1. Adding a category

[MENU] > MEMORY > Memory CH

1. Push [MENU].
2. Select “MEMORY.”
3. Select “Memory CH.”
4. Select “<<Add Category>>.”

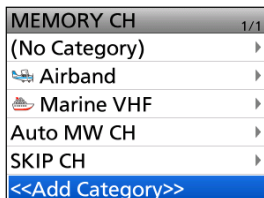

Step 2. Entering a category name

1. Select “Edit Name.”

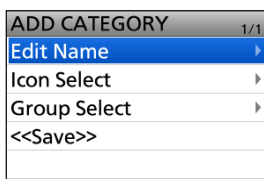

2. Enter a name.

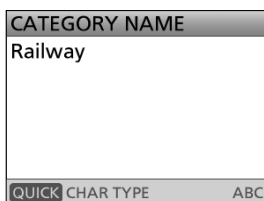

① See page iv on how to enter characters.

Step 3. Selecting a category icon

1. Select “Icon Select.”

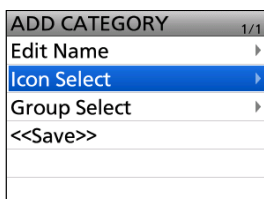

2. Push D-pad to select the icon, and then push [ENT].

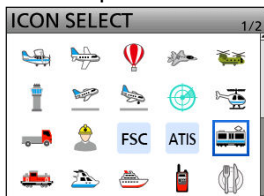

① See the next page for a selectable icon list.

Step 4. Select a group to enter into a category

1. Select “Group Select.”

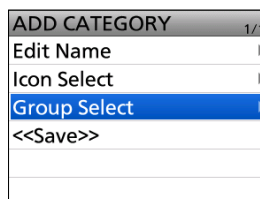

- Groups that have not been assigned a category are displayed in a list.

2. Select the groups.

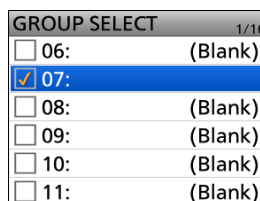

- A “✓” is displayed for the selected group.

3. Push [QUICK].
4. Select “Fix” to enter into a category.

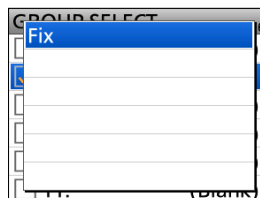

5. Select “<<Save>>.”

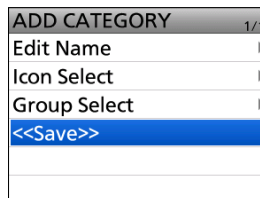

- Beeps sound, then returns to the Memory channel screen.

TIP: To change a category name or icon

1. With the category selected, push [QUICK].

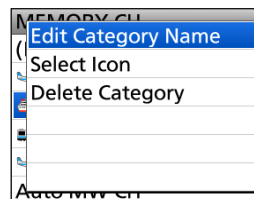

2. Select “Edit Category Name” or “Select Icon.”

About the Category

◇ Deleting a category

Example: Deleting the “Railway” category

[MENU] > MEMORY > **Memory CH**

1. Push [MENU].
2. Select “MEMORY.”
3. Select “Memory CH.”
4. Select “Railway” category.

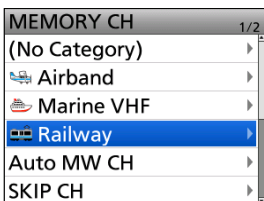

5. Push [QUICK].
6. Select “Delete Category.”

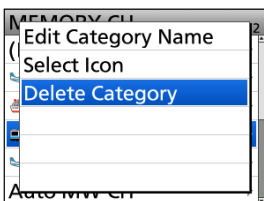

7. Select “YES.”

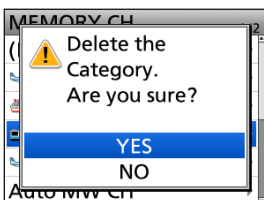

- Beeps sound, then returns to the Memory channel screen.

TIP:

- **To add a group to an entered category**
 1. Select “Add Group”.

A screenshot of the 'Add Group' menu for the 'Airband' category. The menu items are: 00: Narita, 01: Kansai, 02: Dulles, 03: Frankfurt, 04: Heathrow, and <<Add Group>> (highlighted in blue). A '1/1' indicator is in the top right corner.
- **To release a group from an entered category**
 1. With the category selected, push [QUICK].

A screenshot of the 'Release Category' menu. The menu items are: Edit Group Name, Release Category (highlighted in blue), and Clear all M-Ch in the gr.
- 2. Select “Release Category.”

◇ Category icon list

① You can also change the icon from the CS-R15 PROGRAMMING SOFTWARE in the Category Operation sheet. The category icons and names are as follows.

	Airplane		Shopping Center
	Passenger Plane		Fire Engine
	Balloon		Fire Station
	Fighter Aircraft		Ambulance
	Transport Aircraft		Medical
	Control Tower		Hospital
	Takeoff		Bus
	Landing		Building
	Radar Control		Yagi Antenna
	Helicopter		Television
	Truck		Security Guard
	Worker		Leisure
	FSC		Jeep
	ATIS		Base
	Train		Factory
	Electric Locomotive		Car
	Leisure Boat		Telephone
	Ship		Wireless Microphone
	License Free Radio		Base Transceiver
	Restaurant		Portable Transceiver

FM Radio memory

◇ Using the FM Radio Memory

A total of 26 groups are selectable for FM Radio memory.

You can assign up to 50 FM Radio memory channels to each group, for easy memory management. (A maximum of 500 memories can be assigned to the FM Radio memory.)

Some area stations are preloaded into the FM Radio memory for easy memory management.

TIP: The FM Radio memory contents, described in this manual, may differ from your receiver's programmed memory.

About the FM Radio Memory channel contents

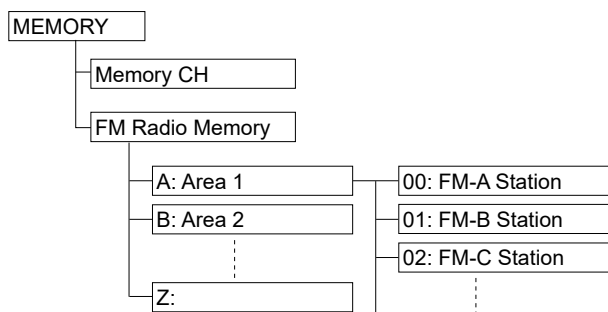

◇ Adding an FM Radio memory

Step 1. Adding an FM Radio memory and entering the edit mode

[MENU] > MEMORY > FM Radio Memory

1. Push [MENU].
2. Select "MEMORY."
3. Select "FM Radio Memory."

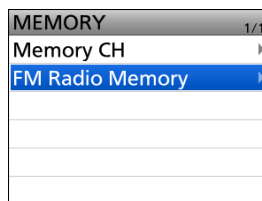

4. Select a desired group.

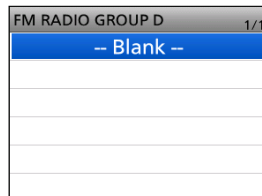
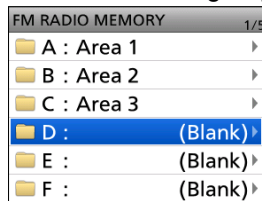

① If there is no memory, "-- Blank --" is displayed.

5. Push [QUICK].
6. Select "Add."

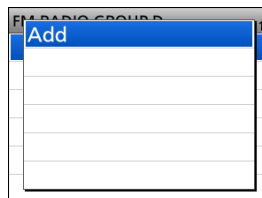

- The FM RADIO MEM EDIT screen is displayed.

TIP: To change the group name, push [QUICK], and then select "Edit Name" in step 4.

3 MEMORY OPERATION

FM Radio memory

◇ Adding an FM Radio memory

Step 2. Entering an FM Radio Memory name

1. Select "NAME."

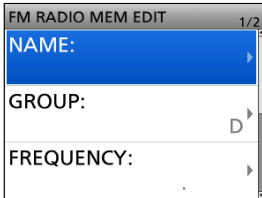

2. Enter a name.

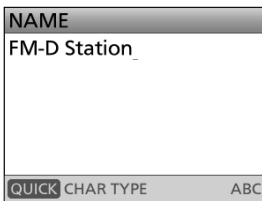

① See page iv on how to enter characters.

3. After entering, push [ENT].

TIP: To change the FM Radio memory group, select "GROUP," then select the desired group.

Step 3. Entering a frequency

1. Select "FREQUENCY."

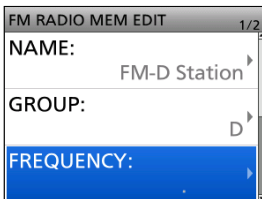

2. Rotate [DIAL] to enter the frequency.

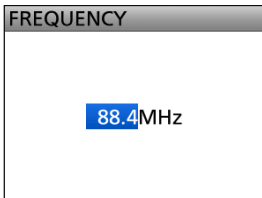

① The usable frequency range differs depending on the receiver's version.

3. After entering, push [ENT].

Step 4. Selecting the skip setting

1. Select "SKIP."



2. Select "OFF" or "SKIP."

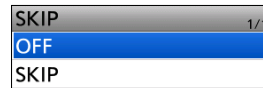

- **OFF:** You can select the memory in the FM Radio Memory mode.
- **SKIP:** The memory is not displayed in the FM Radio Memory mode.

Step 5. Saving the FM Radio Memory

1. Select "<<Add Write>>."



2. Select "YES."

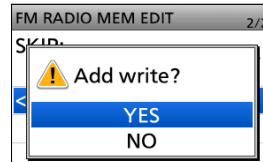

- The entered contents are saved in the FM Radio memory, and the display returns to the selected group screen.

TIP: How to cancel the entered data:

1. Push [MENU].
2. Select "YES."

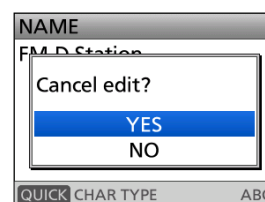

- Cancels the entry and returns to the selected group screen.

3 MEMORY OPERATION

FM Radio memory

◇ Deleting an FM Radio memory

All the contents of an FM Radio memory can be deleted.

NOTE: Deleted memories cannot be restored.

[MENU] > MEMORY > **FM Radio Memory**

1. Push [MENU].
2. Select "MEMORY."
3. Select "FM Radio Memory."

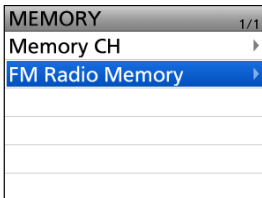

4. Select a group that includes the memory you want to delete.

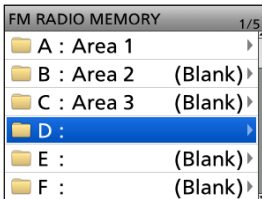

5. Select the memory to be deleted.



ⓘ **DO NOT** push [ENT].

6. Push [QUICK].
7. Select "Delete."

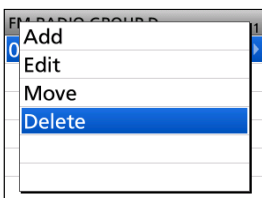

8. Select "YES."



- The selected FM Radio memory is deleted.

3 MEMORY OPERATION

FM Radio memory

◇ Editing an FM radio memory

This function edits FM Radio memory contents. This is useful when already-entered data is incorrect, has changed, or new data should be added to the list.

[MENU] > MEMORY > FM Radio Memory

1. Push [MENU].
2. Select "MEMORY."
3. Select "FM Radio Memory."

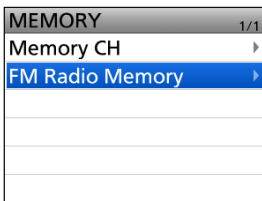

4. Select a group that includes the memory you want to edit.

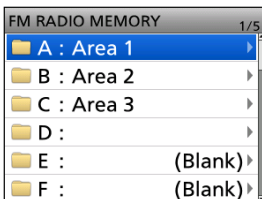

5. Select the memory to be edited.

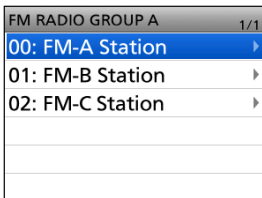

① **DO NOT** push [ENT].

6. Push [QUICK].
7. Select "Edit."

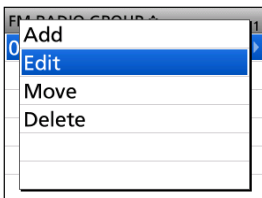

8. Select an item, then edit it.
① See page 3-16 for details.

9. After editing, select "<<Overwrite>>."

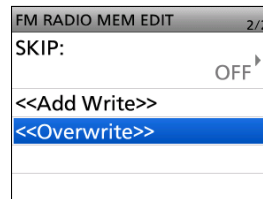

10. Select "YES."

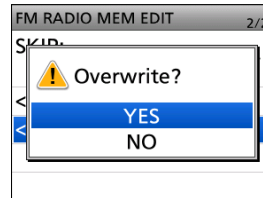

- The memory contents are overwritten and returns to the selected group screen.

FM Radio memory

◇ Rearranging the display order of the FM Radio memories

You can move the entered FM Radio memories to rearrange their display order in the selected FM Radio memory group.

[MENU] > MEMORY > FM Radio Memory

1. Push [MENU].
2. Select "MEMORY."
3. Select "FM Radio Memory."

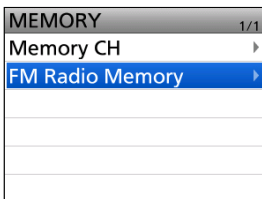

4. Select a group that includes the memory you want to move.

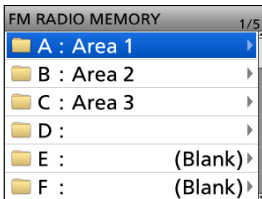

5. Select the memory to be moved.

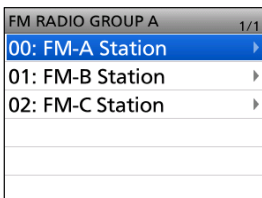

ⓘ **DO NOT** push [ENT].

6. Push [QUICK].
7. Select "Move."

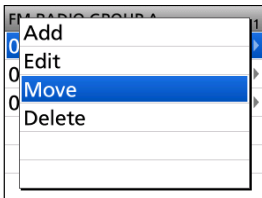

8. Select a memory to insert the memory you want to move above it.

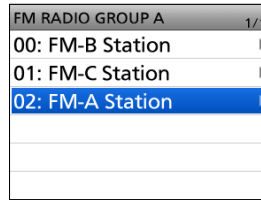
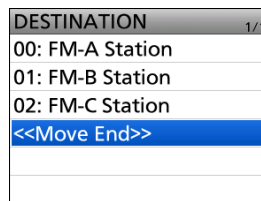

- The selected memory is inserted above the destination memory.
- ⓘ If you select "<<Move End>>," the memory is moved to the bottom of the group.

- Scan Type..... 4-2
 - ◇ VFO scan 4-2
 - ◇ Memory scan..... 4-2
- Starting or canceling the scan 4-2
- About Scans 4-3
 - ◇ [DIAL] operation during a scan 4-3
 - ◇ Squelch setting for a scan 4-3
 - ◇ Tuning step for a VFO scan..... 4-3
 - ◇ Scan Skip function..... 4-3
 - ◇ Receiving mode during a scan 4-3
 - ◇ When a signal is received 4-3
 - ◇ Scan Stop Beep function..... 4-3
 - ◇ Voice Squelch Control (VSC) function..... 4-3
- VFO scan..... 4-4
 - ◇ Entering Program Scan Edges 4-5
 - ◇ About the Program Link Scan 4-6
 - ◇ Setting the Program Link function 4-6
- Memory scan 4-7
 - ◇ Setting the Group Link..... 4-7
- Scan skip settings..... 4-8
 - ◇ Storing the skip frequencies 4-8
 - ◇ Setting the skip channel 4-8
 - ◇ Temporary skip function 4-9

Scanning in the Dualwatch operation

The Dualwatch function simultaneously monitors 2 frequencies.

For example, if you are receiving in the AM mode on one band and scanning on the other band, you may hear noise due to voltage fluctuations when switching frequencies because the 2 receiving circuits share the antenna on the IC-R15. However, this is not a receiver malfunction.

Scan Type

Scanning is a versatile function that can automatically search for signals. A scan makes it easier to locate stations to contact or listen to, or to skip unwanted channels or frequencies.

◇ VFO scan

The VFO scan searches for signals within the specified frequency range.

- Program scan (P00 ~ P24):
Repeatedly scans the selected Program Scan range.
- Program Link (P-LINK0 ~ 9):
Sequentially scans the Program Scan ranges. The links are set on the MENU screen.
- Band: Repeatedly scans the frequency band.
- All bands: Repeatedly scans all bands.
- Auto MW: When a signal is received during a VFO scan, the frequency is automatically stored in an Auto Memory Write channel group (Auto MW CH 000 ~ 199).

◇ Memory scan

The Memory scan searches for signals on the preregistered memory channels.

- Favorite: Sequentially searches through all Favorite memory channels.
- Current Group: Scans the memory channels that are entered in the same group that is currently selected.
- Group Link: Sequentially scans the memory groups that are set to link on the MENU screen.
- Category/Group: Scans the memory channels in the selected category group.
- ALL: Repeatedly scans all memory channels.

◇ Tone scan

The Tone scan searches for signals with tone frequencies or DTCS codes from stations using the Tone Squelch function.

① A Tone scan is usable for only FM/FM-N in the VFO or Memory scan.

Starting or canceling the scan

① Set the VFO mode or memory mode before starting the scan.

1. Push [SCAN].
 - Opens the Scan Type Select window.
 - ① If you hold down [SCAN] for 1 second, the last selected scan starts.
2. Select a scan type.

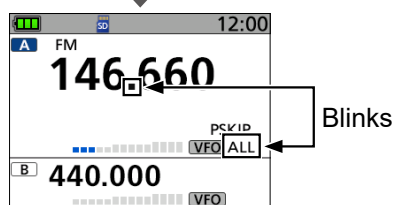
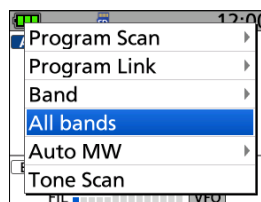

- The scan starts.
- In the VFO mode, the decimal point and the selected Scan Type icon blink.
- In the Memory mode, the decimal point and the Memory icon blink.

① When receiving a signal, the S-meter displays the received signal strength.

① Rotate [DIAL] to change the scanning direction.

3. Push [CLEAR] to cancel the scan.

About Scans

◇ [DIAL] operation during a scan

- Rotate [DIAL] to change the scan direction during a scan.
- When the scan is paused, rotate [DIAL] to resume the scan.

◇ Squelch setting for a scan

You can change the squelch level to suit your operating needs. Set the squelch level to open the squelch, according to the received signal strength.

- ① During a scan, rotate [DIAL] while holding down [SQL] to adjust the squelch level. The scan resumes after adjusting.

◇ Tuning step for a VFO scan

The selected tuning step is applied to the scan. For a Program scan or Program Link scan, set the tuning step in the Program Scan Edge ranges (Program Scan Edge).

◇ Scan Skip function

The skip function speeds up scanning by not scanning those frequencies set as skip channels.

- ① These settings can be separately set to A band and B band.

In the VFO mode

The frequencies that are set as "PSKIP" are skipped during a scan. (p. 4-8)

In the Memory mode

The frequencies that are set as skip channels "PSKIP" and "SKIP" are not scanned. (p. 4-8)

- ① You must enter 2 or more Memory channels to start a memory scan.

TIP: When "Program Skip" is set to OFF, you cannot use the Program Skip scan function. (p. 7-4)
([MENU] > SET > Scan > **Program Skip**)

◇ Receiving mode during a scan

- The VFO scan uses the selected receiving mode.
- During a Memory mode scan, the receiving mode entered into the channel is used.

◇ When a signal is received

When a signal is received, the scan pauses for this set period of time. (p. 7-4)

When a received signal disappears, the scan resumes for this set period of time. (p. 7-4)

- ① These settings can be separately set to A band and B band.

[MENU] > SET > Scan > **Pause Timer**

[MENU] > SET > Scan > **Resume Timer**

◇ Scan Stop Beep function

The Scan Stop Beep function sounds a beep when a signal is received.

This function can be turned ON or OFF on the MENU screen. (p. 7-12)

[MENU] > SET > Sounds > **Scan Stop Beep**

◇ Voice Squelch Control (VSC) function

The Voice Squelch Control function opens the squelch or stops a scan only when voice components are detected in the signal. It is convenient to receive only voice communications.

- ① The function is usable in the FM and FM-N modes.

[QUICK] > **VSC**

4 SCAN OPERATION

VFO scan

The VFO scan searches for signals within the specified frequency range.

Full scan (All bands):

Repeatedly scans the entire band.

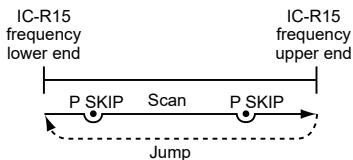

Band scan (Band)

Repeatedly scans the selected band.

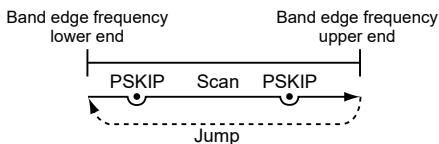

Program scan (P00 ~ P24):

Repeatedly scans the selected Program Scan range (Program Scan Edge 00 ~ 24).

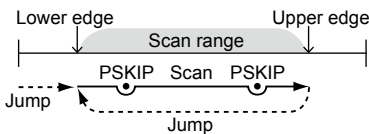

① At least one Program Scan range (Program Scan Edge) must be entered to start a Program scan.

([MENU] > SET > Scan > **Program Scan Edge**)

See page 4-5 for more details.

Program Link scan (P-LINK 0 ~ 9):

Sequentially scans the Program Scan ranges. The links are set on the MENU screen.

([MENU] > SET > Scan > **Program Link**)

① See page 4-6 for more details.

Program scan edges (Example: P00 ~ P10)

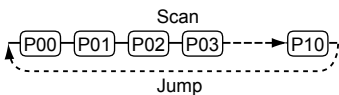

Auto memory write scan (Auto MW)

When a signal is received during a VFO scan, the frequency is automatically stored into an Auto Memory Write channel group (Auto MW CH 000 ~ 199).

([MENU] > MEMORY > Memory CH > **Auto MW CH**)

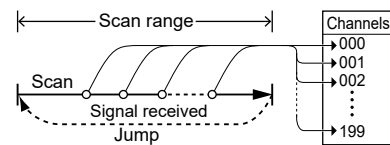

① Information

- The Auto Memory Write scan writes to a memory channel when the scan automatically resumes.
- When no blank channels is left in the Auto Memory Write channel group (000 ~ 199), the scan automatically cancels.
- When you start this scan, you can skip the following dialog on the Menu screen.

“Clear All memories in the Auto MW SCAN group ?
(The Auto MW Scan will then start.)”

① You can hide the dialog from the Scan settings.

([MENU] > SET > Scan >

Auto MW SCAN Memory Clear)

4 SCAN OPERATION

VFO Scan

◇ Entering Program Scan Edges

You can enter the upper and lower frequency edges for a Program scan.

Each Program Scan range has its tuning step and operating mode setting.

You can enter up to 25 Program Scan ranges (Program Scan Edge) on the MENU screen.

[MENU] > SET > Scan > Program Scan Edge

1. Push [MENU].
2. Select "Scan" in the "SET" menu.
3. Select "Program Scan Edge."

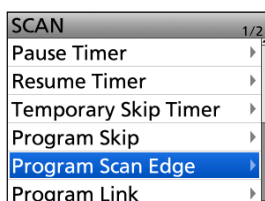

4. Select a blank Program scan range "00" ~ "24."

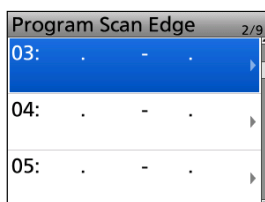

5. **DO NOT** push [ENT].
6. Push [QUICK].
7. Select "Edit."

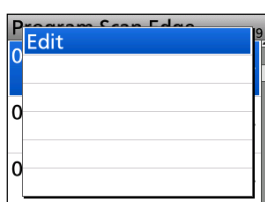

- The edit screen is displayed.
7. Select "FREQ LOW" or "FREQ HIGH" to enter the lower edge and higher edge, and then push [ENT].

① Information

- Rotate [DIAL] to select the item, and then push [ENT] to enter the edit screen.
- Set the lower edge and higher edge by rotating [DIAL].
Push [V/MHz] to select the 1 MHz tuning step.
- When the "NAME" is entered, it displays on the Scan Type Select window.
See page iv on how to enter characters.
- When the "TS" (Tuning Step) and/or "MODE" is blanked, they have used the current setting on the VFO mode.
The "TS" and "MODE" must be set to match with your desired signals.

8. After editing contents, select "<<Write>>."
 - The confirmation dialog is displayed.
9. Select "YES."

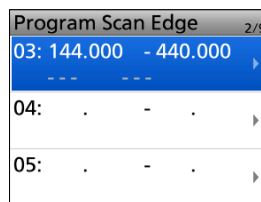
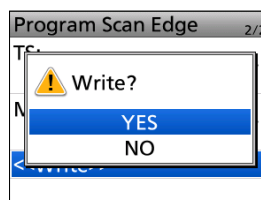

- ① To exit the MENU screen, push [MENU].

TIP:

- To clear the Program scan range, select "Clear" in step 6.
- When scanning a range where the set "TS" or "MODE" cannot be used, the preset "TS" or "MODE" setting on each band is applied.

VFO Scan

◇ About the Program Link Scan

This item sets the Link function for 2 or more Program Scan ranges to sequentially scan during a Program Link scan. The Program Link scan scans all frequencies in the scan ranges.

Example settings of the Program Link:

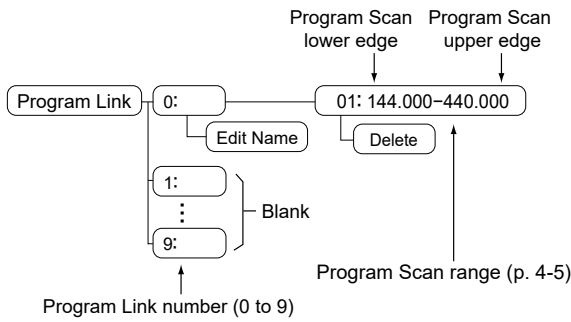

① Information

- The Program Link Number screen displays the frequency range.
- You can add a Link setting by pushing [QUICK] when 2 or more Program Scan ranges (Program Scan Edge) are entered.
- When there is no Program Scan range (P00 ~ P24) entered, "Add" is not displayed after pushing [QUICK].

◇ Setting the Program Link function

[MENU] > SET > Scan > Program Link

1. Push [MENU].
2. Select "Scan" in the "SET" menu.
3. Select "Program Link."

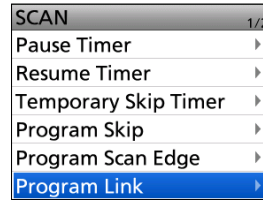

4. Select a Program Link number "0" ~ "9."

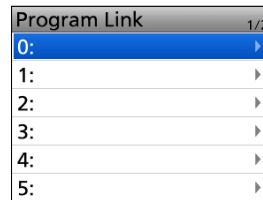

- The Program Link Number screen displays the preregistered Program Scan ranges.
- ① When no Program Scan range is selected, "– Blank –" is displayed.

5. Push [QUICK].
6. Select "Add."

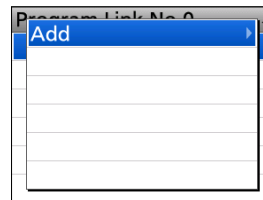

7. Select the Program Scan range that you want to add.

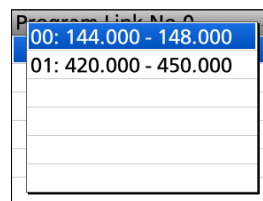

8. Repeat steps 6 and 7 until all Program scan ranges that you want are added.
9. Push [ENT] to save the Program Link.
- ① To exit the MENU screen, push [MENU].

TIP:

- To edit the name of the Program Link, push [QUICK] and select "Edit Name" in step 4 above.
- To delete the registered Program Scan range from the Program Link, select "Delete" in step 6 above.

Memory scan

The Memory scan searches signals on the preregistered memory channels.

ALL:

Repeatedly scans all memory channels.

Memory Groups (00 ~ 99, A: Auto MW CH and S: Skip CH)

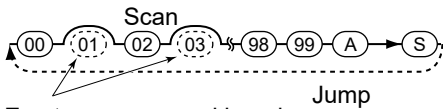

Current Group:

Scans the memory channels that are entered in the same group that is currently selected.

Example: Scanning the selected Memory Group 00

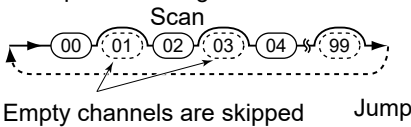

Category/Group:

Scans the memory groups in the selected Category.

Example: Scanning the Memory Group 00 in the Airband category

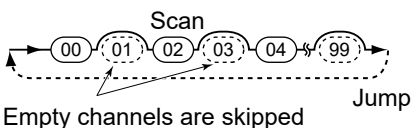

Group Link:

Sequentially scans the memory groups that are set to Link on the MENU screen.

Memory Groups (00 ~ 99)

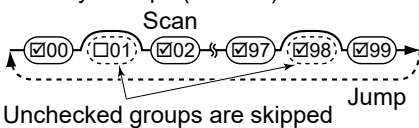

① At least 2 groups must be checked to start a Group Link scan. ([MENU] > SET > Scan > **Group Link**)
See to the right for details.

Favorite:

Sequentially searches through all Favorite memory channels.

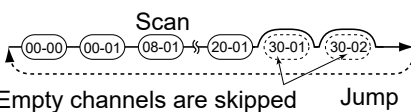

◇ Setting the Group Link

You can sequentially scan the memory groups that are set to Link on the MENU screen.

① In the default setting, all groups are set to Link.

[MENU] > SET > Scan > **Group Link**

1. Push [MENU].
2. Select "Scan" in the "SET" menu.
3. Select "Group Link."

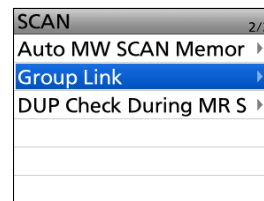

4. Select a Group Link.

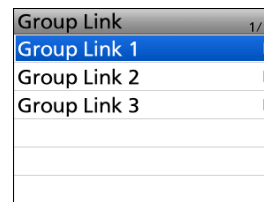

5. Select a group, "00" ~ "99."



6. Push [ENT] to turn the Link function ON or OFF.
 - "☑" is displayed when the function is set to "ON."
- ① Push [QUICK] to quickly turn all the groups ON or OFF.

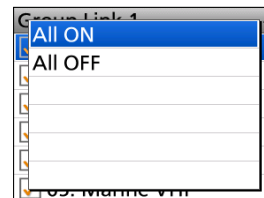

① To exit the MENU screen, push [MENU].

Scan skip settings

◇ Storing the skip frequencies

You can skip unnecessary frequencies during a scan. While a scan is paused, and if you want to skip the frequency, you can store it into the Skip channels group (SKIP CH: 00 ~ 99) as a Skip channel (PSKIP). The Scan Skip function speeds up a scan.

1. While a VFO scan is paused, push [SKIP].
2. Select "Add to SKIP MR Group."

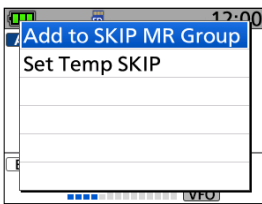

- The window, as shown above, is displayed.
 - Two short beeps sound.
 - The frequency is stored in the Skip channels group.
 - After storing, the scan resumes.
- ① If there is no blank channel, an error beep sounds, and the frequency is not stored.

◇ Setting the skip channel

You can set or clear a Skip Channel setting. The channels that are set as a Skip channel are skipped during a scan.

1. Push [MR] to enter the Memory mode.
① For only the USA version, pushing [MR] each time selects the Memory and Weather Channel modes.
2. Select the memory channel to be skipped.
3. Push [QUICK].
4. Select "SKIP."
5. Select an option.

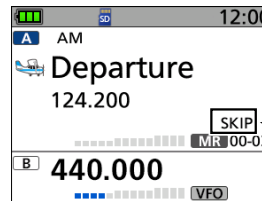
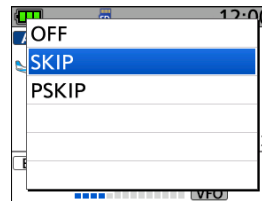

When a Skip channel is set, "SKIP" or "PSKIP" is displayed.

- OFF: Cancels the Skip Channel setting.
- SKIP: Skipped during a Memory scan.
- PSKIP: Skipped during both VFO and Memory scans.

Scan skip settings

◇ Temporary skip function

This function temporarily skips unwanted frequencies (or memory channels) during a scan for the set period of time or condition, without changing the Skip Channel setting.

1. While a scan is paused, push [SKIP].
2. Select "Set Temp SKIP."

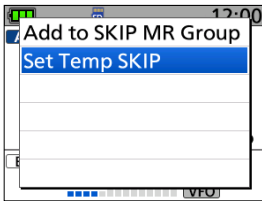

- Sets the frequency or Memory channel as a Skip Frequency or Channel.
- The scan automatically resumes.

TIP:

- Up to 20 Temporary Skip frequencies or Memory channels can be set. When the 21st frequency or Memory channel is set, the oldest setting is automatically deleted.
- You can also set the Temporary Skip function in the Quick Menu window.
- The Temporary Skip function is canceled when the Temporary Skip Timer (Default: 5 min) has passed, or when selecting "Cancel Temp SKIP" in the Quick Menu window.

([MENU] > SET > Scan > **Temporary Skip Timer**)

Section 5 FM RADIO OPERATION

Basic operation.....	5-2
◇ Description	5-2
◇ Turning ON the FM Radio	5-2
◇ Selecting the FM Radio mode	5-2
◇ Searching for an FM Radio signal	5-3
◇ Using the Attenuator function	5-3
◇ Selecting the group in the Memory mode.....	5-4
◇ SKIP Select mode setting.....	5-5
◇ Setting a squelch level	5-6
◇ Using the Monitor function.....	5-6

Basic operation

◇ Description

You can listen to FM Radio broadcasts.

While using the Dualwatch function, you can still listen to the FM Radio only on the A band.

Up to 500 FM Radio Memory channels can be separately stored in 26 groups for easy memory management.

If you only want to listen to FM Radio, set to the single band display or select "FM Radio" in "Simple Mode" on the MENU screen.

TIP: The FM Radio Memory channel contents described in this manual may differ from your receiver's preloaded contents.

The frequency range for the FM Radio:

FM: 76.0 MHz* to 108.0 MHz

* The usable frequency range may differ, depending on the receiver's version.

◇ Turning ON the FM Radio

1. Push [QUICK].
2. Select "<<FM Radio Mode>>."
 - Returns to the Standby screen, and "FM RADIO" is displayed.

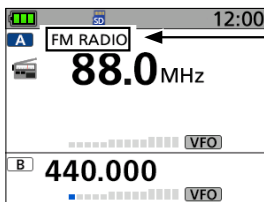
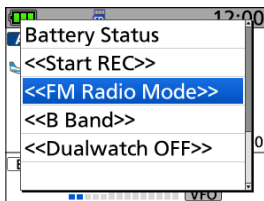

- ① To turn OFF FM Radio, push [QUICK], and then select "<<Exit FM Radio Mode>>."

◇ Selecting the FM Radio mode

1. In the FM Radio mode, push [MR] to toggle between the Tuning or the Memory modes.
2. Rotate [DIAL] to select a frequency or a memory channel.

• Tuning mode

The FM Radio Tuning mode is used to set the desired FM Radio frequency.

When the Tuning mode is selected, "VFO" is displayed.

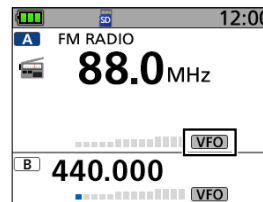

Tuning mode

• Memory mode

The FM Radio Memory mode is very useful to quickly select often-used frequency settings.

When the Memory mode is selected, "MR" and the selected memory channel group (A ~ Z) and number are displayed.

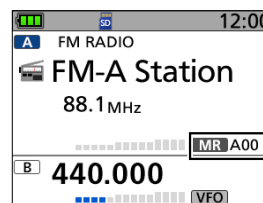

Memory mode

TIP: To save the selected frequency in the FM Radio memory

1. Hold down [MR] for 1 second.
 - The pop up window is displayed.
2. Select "Write to New CH" or "Write to Selected CH."
 - An automatically selected blank channel or a selected channel is displayed.
3. Push [ENT].
 - The confirmation dialog is displayed.
4. Select "YES."

Basic operation

◇ Searching for an FM Radio signal

While in the Tuning mode, hold down D-pad(↔) to start searching for a broadcast signal.

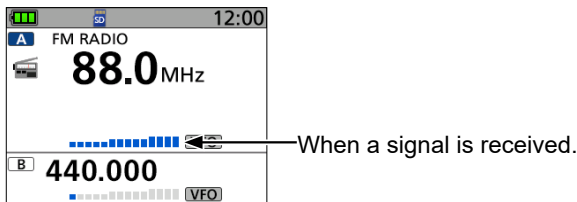
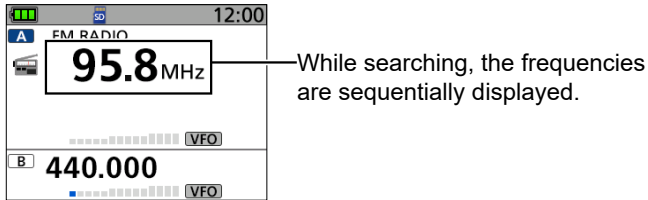

- When you hold down D-pad(←), a down scan starts, and when you hold down D-pad(→), an up scan starts.
- When a signal is received, the scan stops on the frequency.
- To cancel the scan, push D-pad(↔) or [CLEAR].

◇ Using the Attenuator function

The Attenuator prevents a desired signal from becoming distorted when a very strong FM Radio signal is near the frequency, or when a very strong electric field, such as from a broadcasting station, is near your location.

1. Push [QUICK].
2. Select “FM Radio ATT.”



3. Select “ON.”

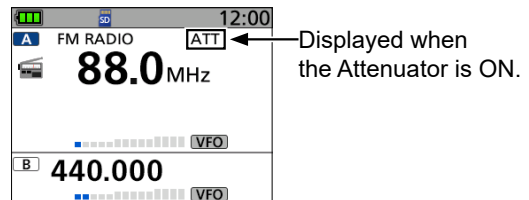
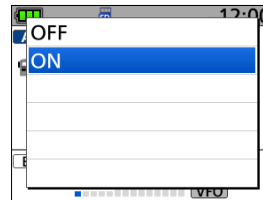

- “ATT” is displayed.

FM Radio memory

◇ **Selecting the group in the Memory mode**

Up to 50 FM Radio Memory channels can be assigned to each group for easy memory management. If you change the group, other area channels can be selected.

1. Push [MR] to select the Memory mode.

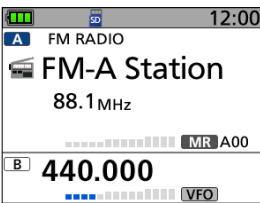

- “MR” and the selected memory channel number is displayed.

2. Push [QUICK].
3. Select “Select Group.”

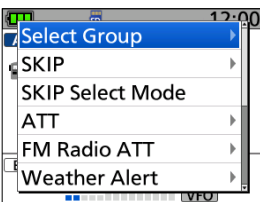

4. Select the desired group.

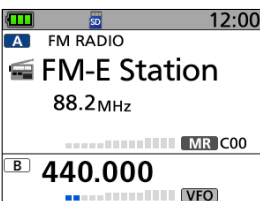
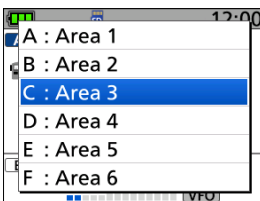

- Returns to the standby screen and the memory channel in the selected group is displayed.

5. Rotate [DIAL] to select a memory channel.

Basic operation

◇ SKIP Select mode setting

You can set memories as skip channels. The selected memories are not displayed in the Memory mode. In the SKIP Select mode, you can select memory channels set as skip channels by rotating [DIAL], making it easy to set and cancel SKIP.

1. Push [MR] to select the Memory mode.

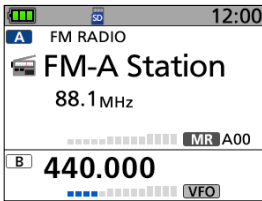

- “MR” and the selected memory channel number is displayed.

2. Push [QUICK].
3. Select “SKIP Select Mode.”

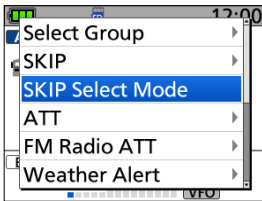

TIP: On the standby screen, push [QUICK], and selecting “SKIP” also sets the skip setting.

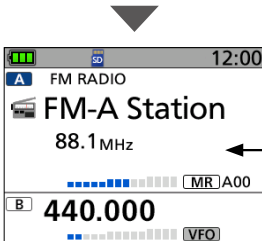

- “DIAL Operation: Displays SKIP CH” is displayed and then “MR” blinks.

4. Rotate [DIAL] to select a channel.
5. Push [SKIP] to set the Skip Channel.

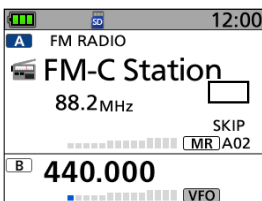

- “SKIP” is displayed when a Skip channel is set.
- ① To cancel the skip setting, push [SKIP] again.
- ① If you want to set other channels, repeat steps 4 and 5.

6. Push [CLEAR] to exit the SKIP Select mode.
- “MR” is displayed.

Basic operation

◇ **Setting a squelch level**

The squelch enables the audio to be heard only while receiving a signal that is stronger than the set level. A higher squelch level blocks weak signals, which enables you to receive only stronger signals. A lower level enables you to hear weak signals.

- While holding down [SQL], rotate [DIAL] to select the squelch level.

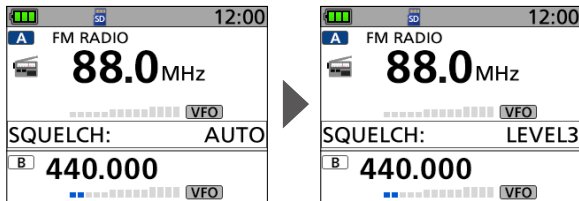

Automatic squelch

Maximum squelch level

① **Information**

- Options: "OPEN," "AUTO" (default), and "LEVEL 1" ~ "LEVEL 3"
- "LEVEL 1" is loose squelch (for weak signals), and "LEVEL 3" is tight squelch (for strong signals).
- "AUTO" is an automatic level adjustment using a noise pulse counting system.
- "OPEN" is the continuously open setting.

◇ **Using the Monitor function**

The Monitor function is used to listen to weak signals without changing the squelch setting.

While holding down [SQL], you can hear weak signals on the frequency.

- The squelch opens.

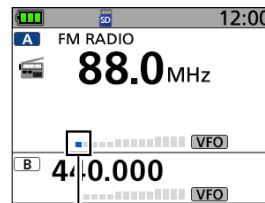

The first segment blinks.

TIP: You can set the Monitor Hold function on the MENU screen. The receiver opens or closes the squelch each time you push [SQL].
 ([MENU] > SET > Function > **Monitor**)

Section 6 RECORDER FUNCTION

NOTE: See the Basic manual Section 6 for details on how to insert or remove a microSD card and precautions.

Recording audio	6-2
Playing back a recorded audio file.....	6-3
Deleting an audio folder/file	6-4
◇ Deleting an audio folder	6-4
◇ Deleting an audio file	6-5
Viewing audio file information.....	6-6
Playing back the recorded audio on a PC	6-7
RECORD items	6-8

Recording audio

You can record the received audio on the MAIN and SUB bands.

NOTE:

- You must insert a microSD card into the receiver before recording audio.
- The recording function is continuously ON, even if the receiver is turned OFF, and then ON again.

To start recording

- Hold down [●REC] for 1 second.



- "Recording started." is displayed.

To stop recording

- Hold down [●REC] for 1 second again.



- "Recording stopped." is briefly displayed, and the audio recording stops.

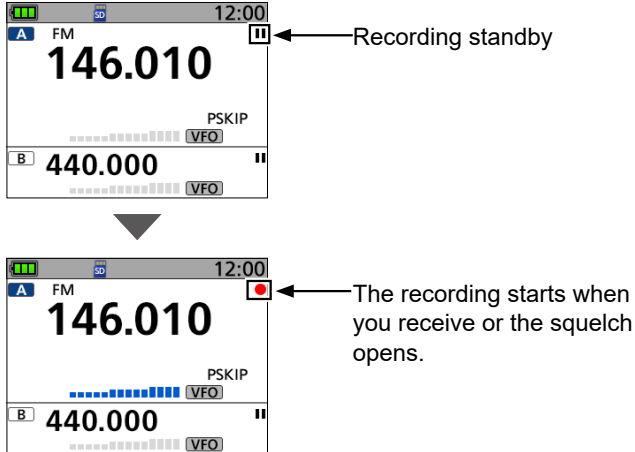

TIP:

- When "RX REC Condition" is set to "Always," the recording is automatically started. In that case, recording continues, even when no signal is received.* (p. 6-8)
([MENU] > RECORD > Recorder Set > **RX REC Condition**)
* The recorded file contains no sound.
- You can select to record the received audio from only the MAIN band or both the MAIN and SUB bands. (p. 6-8)
([MENU] > RECORD > Recorder Set > **REC Operation**)

Information

- The function records the audio on both the MAIN and SUB bands when the Dualwatch function is ON.
- The function records the audio on the displayed band (A or B), when a single band display is selected.
- The recording pauses while no signal is received and resumes when a signal is received again.
- The recording continues until you manually stop recording or the card becomes full.

Playing back a recorded audio file

NOTE: Insert the microSD card that contains the recorded audio file into the receiver's slot.

[MENU] > RECORD > Play Files

1. Push [MENU].
2. Select "RECORD."
3. Select "Play Files."

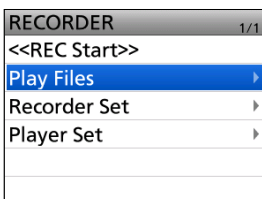

4. Select the folder that contains the audio file to play.

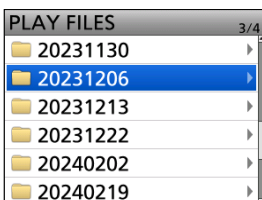

① The folder is named in the following format:
YYYYMMDD (YYYY: Year, MM: Month, DD: Day)

5. Select the audio file to play.

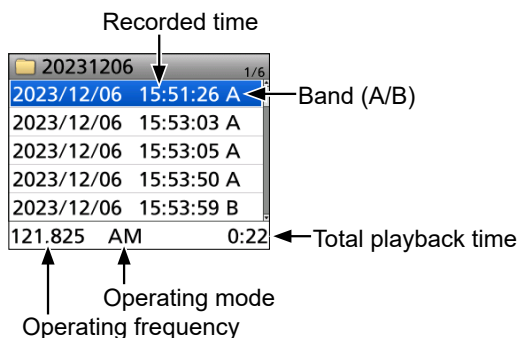

- The VOICE PLAYER screen is displayed, and the file starts to play.

TIP: Selecting the record file type to display.

In step 5 above, push [QUICK], then select "Display File" and select the record file type to display.

- ALL: Displays all recorded files.
- A only: Displays only audio files that were recorded on the A band.
- B only: Displays only audio files that were recorded on the B band.

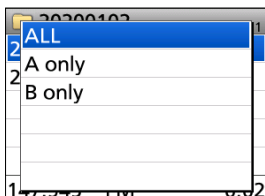

The VOICE PLAYER screen description

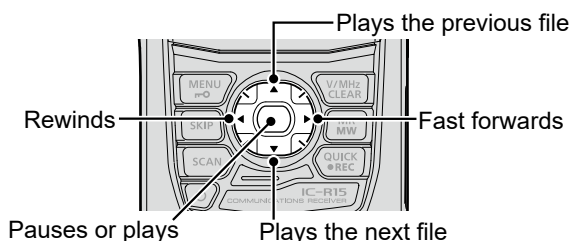
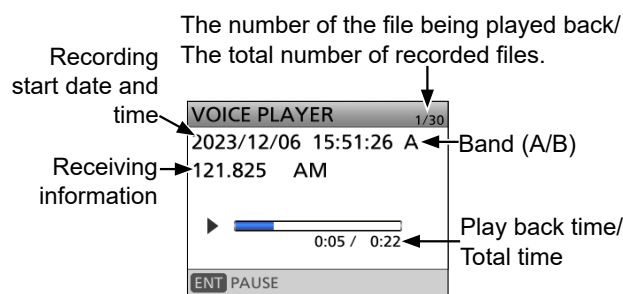

Fast forward: D-pad(←)

Rewind: D-pad(→)

- Hold down to continuously fast forward or rewind the file.
- The default skip time is 10 seconds. If you want to change it, see page 6-8 for details.
- You can fast forward or rewind the file by rotating [DIAL]. The fast forward/rewind time is 1/20 of the total file time, regardless of the skip time setting.
- If you push D-pad(←) within the first 1 second of the file, the end of the previous file is played back.

Playing the previous file: D-pad(↑)

- While the oldest file in the folder is playing back, pushing D-pad(↑) plays back the same file.
- While the file is paused, pushing the D-pad(↑) moves it to the beginning of the previous file.

Playing the next file: D-pad(↓)

While the latest file in the folder is playing back, pushing D-pad(↓) plays back the same file.

Deleting an audio folder/file

NOTE: A deleted audio file can NOT be recovered.

◇ Deleting an audio folder

NOTE: All audio files in the folder are deleted.

[MENU] > RECORD > Play Files

1. Push [MENU].
2. Select "RECORD."
3. Select "Play Files."

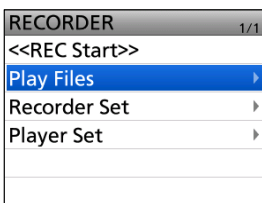

4. Select the folder to delete.

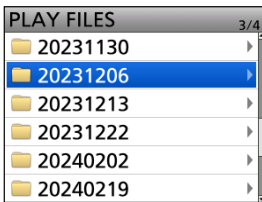

5. Push [QUICK].
6. Select "Delete."

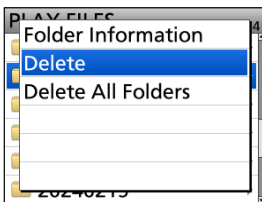

- The confirmation dialog is displayed.
7. Select "YES."

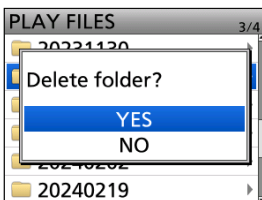

- The folder is deleted.
- ① To exit the MENU screen, push [MENU].

TIP: To delete all folders
Select "Delete All Folders" in step 6.

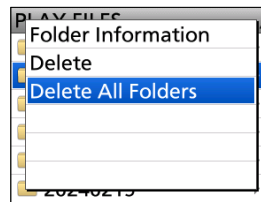

Deleting an audio folder/file

◇ Deleting an audio file

[MENU] > RECORD > Play Files

1. Push [MENU].
2. Select "RECORD."
3. Select "Play Files."

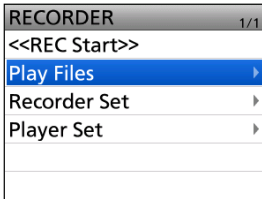

4. Select the folder that contains the audio file to delete.

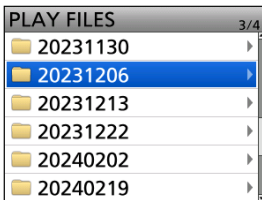

5. Select the audio file to delete.

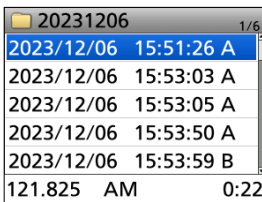

① **DO NOT** push [ENT].

6. Push [QUICK].
7. Select "Delete."

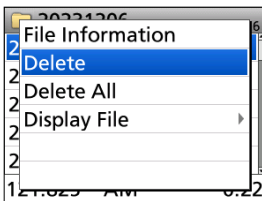

- The confirmation dialog is displayed.

8. Select "YES."

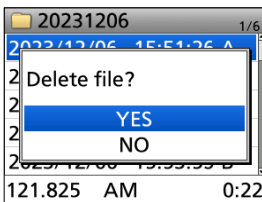

- The file is deleted.

① To exit the MENU screen, push [MENU].

TIP: To delete all files

Select "Delete All" in step 7.

① If "Display File" is set to "A only" or "B only," only displayed files are deleted. (p. 6-3)

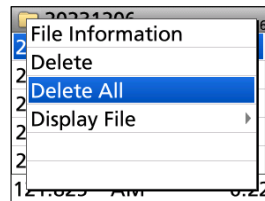

"Display File" is "ALL"

Viewing audio file information

The recorded audio file contains the received frequency, mode, date, and so on.

[MENU] > RECORD > Play Files

1. Push [MENU].
2. Select "RECORD."
3. Select "Play Files."

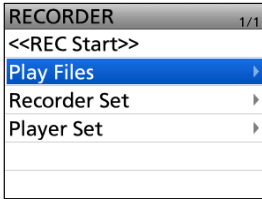

4. Select the folder that contains the audio file to view the information.

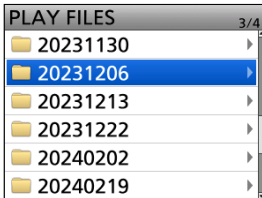

5. Select the audio file to view the information.

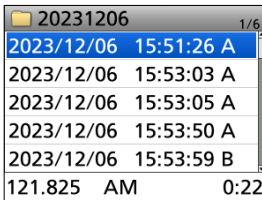

① DO NOT push [ENT].

6. Push [QUICK].
7. Select "File Information."

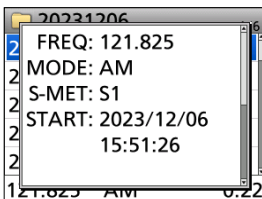
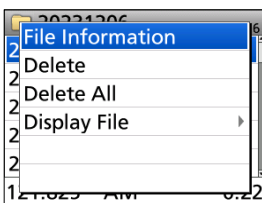

8. Rotate [DIAL] to change the screen.
① To exit the MENU screen, push [MENU].

TIP: To view the folder information
Push [QUICK] in step 4, and then select "Folder Information" to view the folder information.

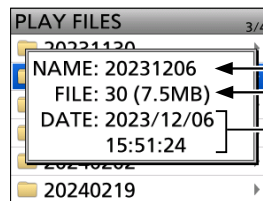
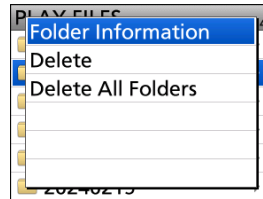

Folder name
Total files (total size)
Created date and time

Playing back the recorded audio on a PC

You can play back the recorded audio on your PC.
 ① The recorded information (frequency, date, and so on) is not displayed.
 ② Windows 11 is used for these instructions.

Example: Connecting the receiver and PC with a USB cable, then playing the audio file on the microSD card on your PC.

NOTE: Insert the microSD card that contains the recorded audio file into the receiver's slot.

[MENU] > SET > Function > **USB Connect**

1. Connect the receiver and PC with a USB cable.

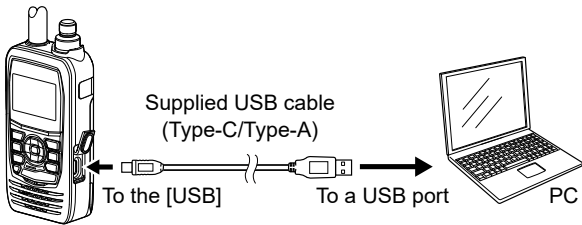

2. Push [MENU].
3. Select "Function" in the "SET" menu.
4. Select "USB Connect."
5. Select "SD Card Mode."
 • A confirmation dialog is displayed.
6. Select "YES."
 • The receiver is connected to the PC in the SD Card mode, and the SD card folder is displayed on the PC screen.
 • The microSD card are directly accessed from the PC.
7. Double-click the 'IC-R15' folder.

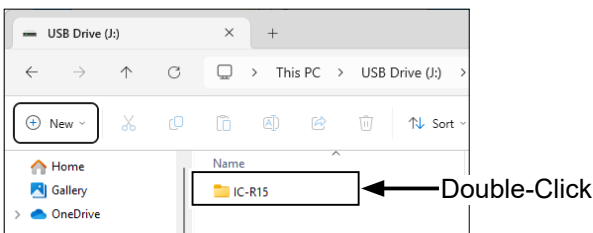

8. Double-click the 'Voice' folder.

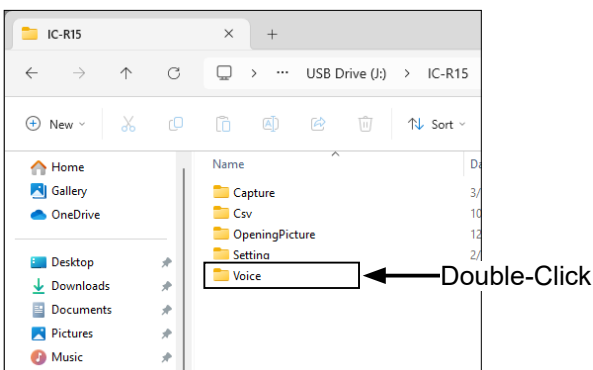

9. Double-click the folder that contains the audio file to play it back. (Example: "20231130")

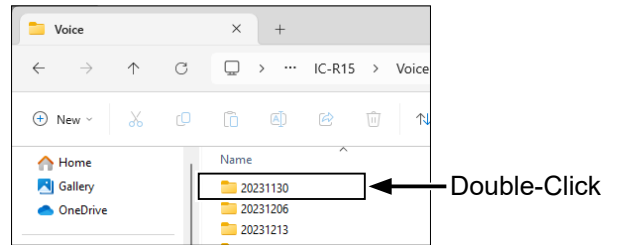

10. Double-click the file to play it back. (Example: "202301130_120013A.wav")

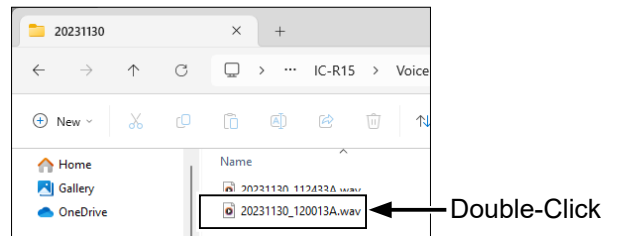

- ① See the instruction manual of your player for operation details.
- ② The audio file may not play back, depending on the player.

RECORD items

<<REC Start>>

[MENU] > RECORD > <<REC Start>>

After selecting “<<REC Start>>,” the recording starts.

- “Recording started.” is displayed.

① Information

- **BE SURE** to insert a microSD card.
- While recording, “<<REC Stop>>” is displayed on the RECORDER screen. To stop recording, select “<<REC Stop>>.”
- Once recording has started, the recording will continue, even if the receiver is turned OFF and then ON again.

Play Files

[MENU] > RECORD > Play Files

Displays saved audio data folders.

- ① **BE SURE** to insert a microSD card.

Playing back:

1. Select a folder that contains the file you want to playback.
2. Select a file to playback.
 - The VOICE PLAYER screen is displayed and starts playing back the audio.
 - ① See page 6-3 for details.
3. Push [MENU] to exit the VOICE PLAYER screen.

NOTE:

- The folder is automatically named, as shown below:
(Example)
Recording date: 12th March 2024
Folder name: 20240312
- The file is automatically named, as shown below:
(Example)
Recording date and time: 12th March 2024 09:30:00
File name: 20240312_093000A*
* “A” stands for A band.
- The audio is recorded onto a microSD card and saved in the “wav” format. (“.wav” is not displayed on the receiver’s screen.)
- The recorded audio can also be played back on a PC.

RX REC Condition

(Default: Squelch Auto)

[MENU] > RECORD > Recorder Set > RX REC Condition

Selects whether or not the squelch status affects the received audio recording.

- **Always:** The receiver always records the received audio regardless of the squelch status.
- **Squelch Auto:** The receiver records the audio only when a signal is received (the squelch is opened). When the squelch closes while recording, the recording will continue for 2 seconds and then pause.

File Split

(Default: ON)

[MENU] > RECORD > Recorder Set > File Split

Turns the File Split function ON or OFF.

- **OFF:** Once a recording starts, the receiver continues to record on the same file.
 - ① If the file size exceeds 4 GB, a new file is automatically created in the same folder, and the audio is recorded there.
- **ON:** During recording, if reception or squelch status* (open and close) is changed, a new file is automatically created in the same folder, and the audio is saved into a new file.
* Only when “REC Condition” is set to “Squelch Auto.”

REC Operation

(Default: A/B Link)

[MENU] > RECORD > Recorder Set > REC Operation

Select the recording operation on the dual band display.

- **A/B Separate:** The recording function is separately active/inactive on the selected band (MAIN band) when the function is started or stopped.
- **A/B Link:** The recording function is simultaneously active/inactive on both MAIN and SUB bands when the function is started or stopped.
 - ① On the single band display, only the displayed band (A or B) is recorded.

Skip Time

(Default: 10sec)

[MENU] > RECORD > Player Set > Skip Time

Set the Skip Timer to 3, 5, 10, or 30 seconds to rewind or skip forward for this set period of time when you push the fast-rewind or fast-forward key while playing the recorded audio.

- ① See “The VOICE PLAYER screen description” for forwarding or rewinding. (p. 6-3)

Section 7 SET MODE

Selecting an item	7-2
◇ MENU screen operation	7-2
◇ SET mode description	7-3
Scan	7-4
Function	7-6
Display	7-9
Sounds	7-12
Time Set	7-13
SD Card	7-14
Bluetooth Set	7-15
Others	7-15

Selecting an item

You can open the MENU screen by pushing [MENU]. You can use the MENU screen to set infrequently changed values or function settings. In addition to this page, see pages 7-4 through 7-15 for details of each item's options and default values.

◆ MENU screen operation

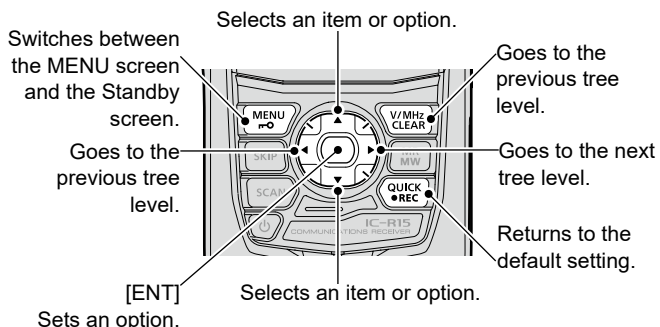

Simplified description—'Select' operation

In this manual, the user's 'Select' operation is simplified, as described below.

Simplified description:

1. Push [MENU].
2. Select "30min."

Operation:

1. Push [MENU] to open the MENU screen.
2. Push D-pad(↓) to select "30min," and then push [ENT].

TIP: The MENU screen is constructed in a tree structure. You may go to the next tree level or go back a level, depending on the selected item.

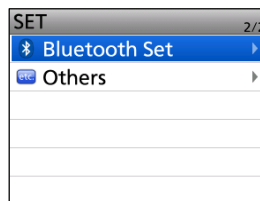
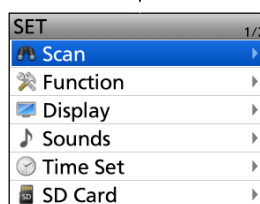
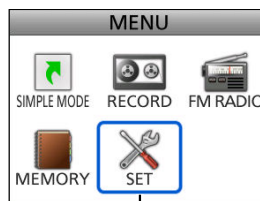

Selecting an item

◇ SET mode description

Example: Set “Auto Power OFF” to “30 min.”

[MENU] > SET > Function > Auto Power OFF

1. Push [MENU].
2. Select “SET.”
3. Select “Function.”

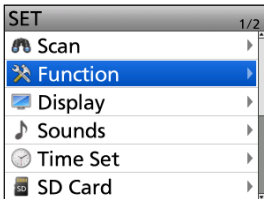

4. Select “Auto Power OFF.”

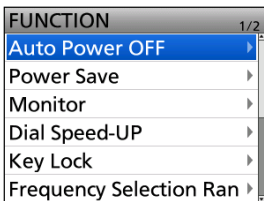

5. Select “30min.”

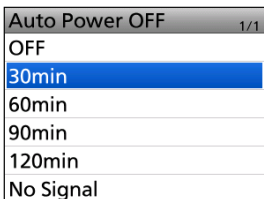

- Sets the option, then goes back to a tree level.
(The FUNCTION screen is displayed.)
- ① To exit the MENU screen, push [MENU].

TIP: To return to the default setting

1. Push [QUICK] in step 5.
2. Select “Default.”

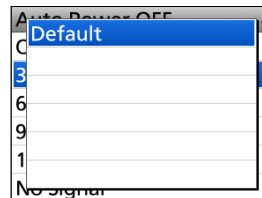

- The setting returns to the default.

NOTE: The default settings shown below are for the USA version. The default settings may differ, depending on your receiver version.

Scan

Pause Timer (Default: 10sec)

[MENU] > SET > Scan > **Pause Timer**

Selects the Scan Pause Timer. When receiving a signal, the scan pauses for this set period of time.

- ① Individually selectable for A band and B band.
- 2sec ~ 20sec: When a signal is received, the scan pauses for 2 ~ 20 seconds (in 2 second steps).
- HOLD: The scan pauses on a received signal until the signal disappears.

Resume Timer (Default: 2sec)

[MENU] > SET > Scan > **Resume Timer**

Selects the scan Resume Timer. When a received signal disappears, the scan resumes for this set period of time.

- ① Individually selectable for A band and B band.
- 0sec: The scan resumes immediately after the signal disappears.
- 1sec ~ 5sec: The scan resumes 1 ~ 5 seconds after the signal disappears.
- HOLD: The scan remains paused for the "Pause Timer" setting, even if the signal disappears.

NOTE: Rotate [DIAL] to resume the scan.

Temporary Skip Timer (Default: 5min)

[MENU] > SET > Scan > **Temporary Skip Timer**

Selects the effective time of the Temporary Skip function.

- ① Individually selectable for A band and B band.
- ① This timer is activated for the VFO scan and the Memory scan.
- 5min/10min/15min: The Temporary Skip channels are skipped for the set period of time.
- While Scanning: The Temporary Skip channels are skipped until the scan is stopped.
- While Powered ON: The Temporary Skip channels are skipped until the receiver is turned OFF.

Program Skip (Default: ON)

[MENU] > SET > Scan > **Program Skip**

Turns the Program Skip Scan function ON or OFF for a VFO scan. This function enables the receiver to skip the unwanted frequencies that are entered as a Memory channel and are set to "PSKIP."

- ① Individually selectable for A band and B band.
- OFF: The receiver scans all frequencies.
- ON: The receiver does not scan frequencies set as "PSKIP" frequencies.

Program Scan Edge

[MENU] > SET > Scan > **Program Scan Edge**

You can delete, copy, or edit the upper and lower frequencies for programmed scans.

The receiver has a total of up to 25 frequency ranges (00 ~ 24), and you can set the scan name, frequencies step, and operating mode for each scan edge.

- ① The default setting may differ, depending on the receiver version.

Program Link

[MENU] > SET > Scan > **Program Link**

Sets the Link function for 2 or more Program Scan Edge ranges to be sequentially scanned during a Program Link Scan. The Link function scans all frequencies in the scan range.

Default settings of the Program Link:

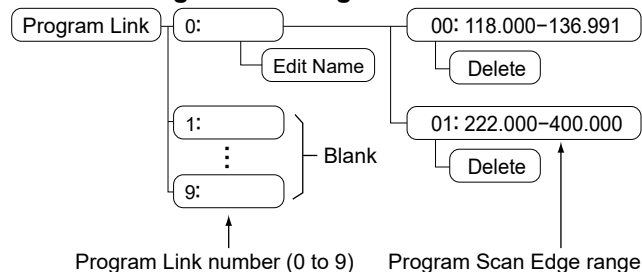

- ① The default setting may differ, depending on the receiver version.

- ① When only one Program Scan Edge range is entered, or no Programmed Scan Edge is left, "Add" is not displayed after pushing [QUICK].

Scan

Auto MW SCAN Memory Clear

(Default: Display Dialog)

[MENU] > SET > Scan >

Auto MW SCAN Memory Clear

Selects whether or not to delete Auto Memory Write channel (Auto MW CH) contents when the Auto Memory Write scan starts.

- OFF: Does not delete the Auto MW CH contents when the Auto Memory Write scan starts.
- Display Dialog: Displays the dialog to select whether or not to delete the Auto MW CH contents when the Auto Memory Write scan starts.
- ON: Deletes the Auto MW CH contents when the Auto Memory Write scan starts.

Group Link

(Default: 00 ~ 99)

[MENU] > SET > Scan > **Group Link**

Selects groups to be scanned during a Group Link Scan. The Group Link function scans all channels in the selected groups.

Select a group, 1 ~ 3, and then push [ENT] to turn the Link function ON or OFF.

① Displays "✓" when the function is set to ON.

DUP Check During MR Scan

(Default: OFF)

[MENU] > SET > Scan >

DUP Check During MR Scan

During a Memory scan, select whether or not to scan the offset frequency if Duplex is set on the channel.

- OFF: The offset frequency is not scanned.
- ON: The offset frequency is also scanned.

Function

Auto Power OFF (Default: OFF)

[MENU] > SET > Function > **Auto Power OFF**

Selects whether or not to automatically turn OFF the receiver after inactivity for this set period of time.

- ① "AUTO POWER OFF" is displayed and beeps sound 5 seconds before turning OFF the receiver. If you operate the receiver during this period of time, the Auto Power OFF timer is reset.
- OFF: Does not turn OFF the receiver.
- 30/60/90/120min: Turns OFF the receiver after inactivity for this set period of time.
- No Signal: The receiver will turn OFF when no signal is continuously received for 3 minutes.

Power Save (Default: Auto (Short))

[MENU] > SET > Function > **Power Save**

Sets the Power Save function to reduce the current drain and conserve battery power. When the Power Save function is activated, the call sign or the beginning of the signal may not be received correctly.

- OFF: Turns OFF the function.
- Auto (Short): Sets the Power saving time to "Short."

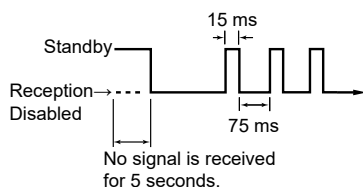

- Auto (Middle): Sets the Power saving time to "Middle."

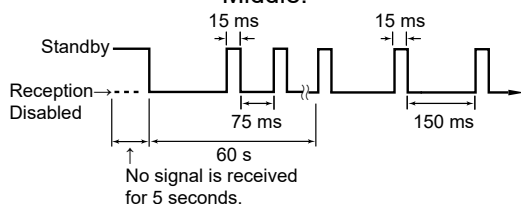

- Auto (Long): Sets the Power saving time to "Long."

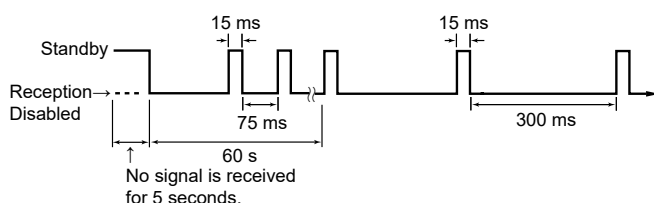

NOTE: The Power Save function is disabled when:

- Using an external DC power source.
- Scanning.

Monitor (Default: Push)

[MENU] > SET > Function > **Monitor**

Selects an option for the [SQL] Monitor function.

① See the Basic manual Section 3 for details.

- Push: Hold down [SQL] to monitor the frequency. Release to stop monitoring.
- Hold: Push [SQL] momentarily to monitor the frequency and push momentarily again to cancel it.

Dial Speed-UP (Default: ON)

[MENU] > SET > Function > **Dial Speed-UP**

Turns the Dial Speed Acceleration ON or OFF.

The acceleration automatically increases the tuning speed when you rapidly rotate [DIAL].

- OFF: Turns OFF the function.
- ON: Turns ON the function.

Key Lock (Default: Normal)

[MENU] > SET > Function > **Key Lock**

Selects the key lock type when the Key Lock function is ON.

NOTE: Regardless of the setting, you can still use [⏻] and [M-O] even if the Key Lock function is ON.

- Normal: All keys and dials, except [SQL] and [VOL] are locked.
- No SQL: All keys and dials, except [SQL], are locked.
- No VOL: All keys and dials, except [VOL], are locked.
- ALL: All keys and dials are locked.

Frequency Selection Range (Default: All bands)

[MENU] > SET > Function > **Frequency Selection Range**

Sets whether the frequency range selected by rotating [DIAL] is fixed within the receive band.

① This setting does not affect the scan.

- In-band: When you change the frequency on the band edge, the top or bottom frequency in the displayed band is selected.
 - ① To change the receive band, select "Select Band" from the Quick menu or push D-pad(↵).
- All bands: When you change the frequency, the next band is displayed. Set the selectable frequencies on the receiver to all bands for continuous selection.

Function

Memory Selection Range (Default: All Groups)[MENU] > SET > Function > **Memory Selection Range**

Sets whether the memory channel range selected by rotating [DIAL] is fixed within a group or category.

- The Current Group:
When you change the memory channel, you can select from the displayed groups.
- The Current Category:
When you change the memory channel, you can select from the displayed category.
- All Groups: When you change the memory channel, you can select from all channels.

① This setting does not affect the scan.

② To change the receive band, select "Select Band" from the Quick menu or push the D-pad(↔).

CI-V Address (Default: B0)[MENU] > SET > Function > CI-V > **CI-V Address**

Sets the CI-V address in hexadecimal code.

① To distinguish devices, each CI-V receiver or transceiver has its own Icom standard address. "B0" is the default address of the IC-R15. When 2 or more IC-R15 are simultaneously controlled by a PC, set a different address for each receiver between 02 and DF (hexadecimal).

CI-V Baud Rate (SP Jack) (Default: Auto)[MENU] > SET > Function > CI-V > **CI-V Baud Rate (SP Jack)**

Sets the CI-V data transfer speed when remotely controlling the receiver through the [↻] jack, to 4800, 9600, 19200 bps, or Auto. When "Auto" is selected, the baud rate is automatically set according to the controller's data rate.

CI-V Transceive (Default: OFF)[MENU] > SET > Function > CI-V > **CI-V Transceive**

Turns the Transceive function ON or OFF.

- OFF: The status is not output.
- ON: The status is output. When you change a receiver setting, the same change is automatically set on other connected transceivers or receivers, and vice versa.

CI-V Echo Back (USB Jack) (Default: OFF)[MENU] > SET > Function > **CI-V Echo Back (USB Jack)**

Sets whether or not to turn the Data Echo Back function ON or OFF, when remotely controlling the IC-R15 through the [USB] CI-V port.

- OFF: Turns OFF the function.
- ON: Turns ON the function.

CI-V USB→REMOTE Transceive Address (Default: 00)[MENU] > SET > Function > CI-V > **CI-V USB→REMOTE Transceive Address**

If you remotely operate your receiver through a USB cable when "CI-V Transceive" is set to ON, the devices in the same system are also externally controlled through the [↻] jack.

To prohibit the external control of an Icom receiver, set this value to other than "00."

The control signal is output from the [↻] jack.

Select an address between 00 and DF (hexadecimal).

USB Connect (Default: Serialport)[MENU] > SET > Function > **USB Connect**

Selects the mode when connecting the receiver to a PC with a USB cable.

- Charge Only:
You can only charge the receiver using a USB cable.
- Serialport:
You can program and remotely control the receiver using the CI-V commands.
① You need to install the USB driver.
② When a PC is connected, the USB connection indicator  is displayed on the receiver.
- SD Card Mode:
You can transfer the files between the inserted microSD card and a PC, using a USB cable.
① A confirmation dialog is displayed. (p. 2-9)

NOTE:

- Use a data communication compatible USB cable when "Serialport" or "SD Card Mode" is selected.
- While in the SD Card Mode, the receiver works not as a receiver but as a data storage device. It temporarily stops recording and logging.

TIP: Download the USB driver and the installation guide from the Icom website.

<https://www.icomjapan.com/support/>

Function

Heterodyne (Default: Normal)

[MENU] > SET > Function > **Heterodyne**

Selects the 1st Local Oscillator frequency. Depending on a combination of the 2 operating frequencies in the Dualwatch mode, the receiver might generate a spurious signal on a specific receive frequency. This may cause the S-meter to fluctuate, even when no signal is received, for example. If this occurs, the Heterodyne function may help. The Heterodyne function shifts the 1st Local Oscillator frequency to the opposite side of the signal to change the frequency combination.

Screen Capture [PWR] Key (Default: OFF)

[MENU] > SET > Function > **Screen Capture [PWR] Key**

Assigns the Screen Capture function to [⏏].

- OFF: [⏏] does not act as the Screen Capture key.
- ON: Pushing [⏏] captures the receiver display onto a microSD card.

Screen Capture File Type (Default: BMP)

[MENU] > SET > Function > **Screen Capture File Type**

Sets the file format for the Screen Capture function to PNG or BMP.

Display

Backlight (Default: Auto (DC IN:ON))

[MENU] > SET > Display > **Backlight**

Selects an option for the receiver backlight.

- OFF: The backlight does not light.
- ON: The backlight lights continuously.
- Auto: The backlight lights when you push a key or rotate [DIAL], and reduces the brightness* after the set period of time in "Backlight Timer."
- Auto (DC IN:ON): The backlight lights when you push a key or rotate [DIAL], and reduces the brightness* after the set period of time in "Backlight Timer."
 ① When an external DC power source is connected, lights continuously.

* When "Dim Screen" is set to "OFF," the backlight goes out after the set period of time in "Backlight Timer."

Backlight Timer (Default: 10sec)

[MENU] > SET > Display > **Backlight Timer**

Sets the Backlight Timer to 5, 10, or 30 seconds. Depending on the "Backlight" setting, the backlight lights for this set period of time and then automatically reduce the brightness.

① When "Dim Screen" is set to "OFF," the backlight goes out after this set period of time.

Brightness (Default: 8)

[MENU] > SET > Display > **Brightness**

Sets the LCD backlight brightness level to between 1 (dim) and 8 (bright).

Dim Screen (Default: ON)

[MENU] > SET > Display > **Dim Screen**

Selects whether or not to automatically reduce the backlight brightness.

- OFF: The backlight immediately goes out after the set period of time in the "Backlight Timer."
- ON: The backlight brightness automatically changes to the "Brightness (Dim)" level after the set period of time in "Backlight Timer" and goes out after the set period of time in "Dim Timer."

The image of the Dim Screen function

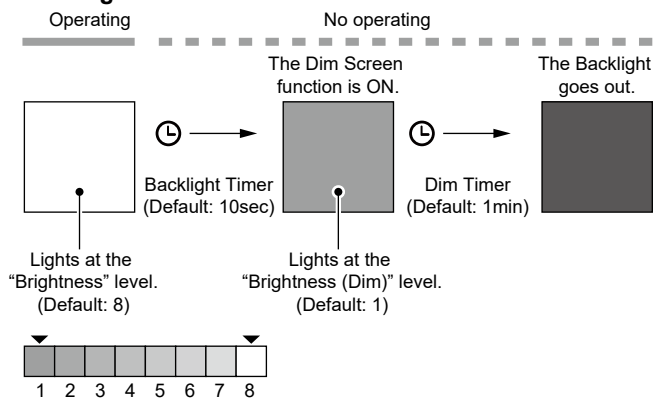

Dim Timer (Default: 1min)

[MENU] > SET > Display > **Dim Timer**

Sets the Dim Timer to 1, 2, 5, or 10 minutes, or Hold. Depending on the "Dim Screen" setting, the backlight lights at the "Brightness (Dim)" level for this set period of time, and then automatically goes out.

- 1/2/5/10min: The backlight goes out after this set period of time.
- Hold: The backlight does not go out.

Brightness (Dim) (Default: 1)

[MENU] > SET > Display > **Brightness (Dim)**

Sets the LCD backlight brightness level for the set period of time in "Dim Timer," to between 1 (dim) and 7 (bright).

- ① Set a lower level than "Brightness." If you set a higher level than "Brightness," the Dim Screen function does not work.
- ① You can check the brightness at each level on the "Brightness" screen.

Display

RX Backlight (Except Radio) (Default: OFF)

[MENU] > SET > Display > **RX Backlight (Except Radio)**

Turns the RX Backlight function ON or OFF. This function turns ON the backlight when receiving a signal other than FM radio.

- OFF: Turns OFF the function.
- ON: The backlight automatically lights when receiving a signal other than FM radio.

NOTE:

- The function is enabled only when the “Backlight” is set to “Auto” or “Auto (DC IN: ON).” ([MENU] > SET > Display > Backlight)
- The backlight lights even if the function is OFF, when the “Backlight” is set to “ON” or “Auto (DC IN: ON).”
- The backlight automatically turns OFF, according to the “Backlight Timer” and the “Dim Timer” settings.

Display Language (Default: English)

[MENU] > SET > Display > **Display Language**

Sets the screen display language to English or Japanese.

① This item is displayed only when “System Language” is set to “Japanese.”

Scroll Speed (Default: Fast)

[MENU] > SET > Display > **Scroll Speed**

Sets the scrolling speed displayed on the screen to “Slow” or “Fast.”

Opening Message (Default: ON)

[MENU] > SET > Display > **Opening Message**

Selects whether or not to display the opening message at power ON.

When you set this item to “ON,” the Icom logo and the model are displayed.

Battery Level (Power ON) (Default: ON)

[MENU] > SET > Display > **Battery Level (Power ON)**

Selects whether or not to display the battery pack level on the receiver’s display at power ON.

- OFF: The battery level is not displayed.
- ON: The battery level is displayed.

Display Type (Default: Name)

[MENU] > SET > Display > **Display Type**

Selects a display position of the memory name.

- Freq: The memory name is displayed under the frequency.
- Name: The memory name is displayed above the frequency.

Display

System Language (Default: English)

[MENU] > SET > Display > **System Language**

Sets the system language of the receiver.

- English: The system language of the receiver is English. Only alphabetical characters (A to Z, a to z, 0 to 9) and symbols (! " # \$ % & ' () * + , - . / : ; < = > ? @ [\] ^ _ ` { | } ~) can be displayed. If Japanese characters (Kanji, Hiragana, and Katakana) are included, the display shows “=” or “_” instead of that character. In that case, you can only delete “=” or “_” in the receiver’s edit mode.
- Japanese: The system language of the receiver is Japanese. Kanji, Hiragana, and Katakana characters, and the 2-bytes symbols can be displayed. To display such characters in the Menu mode, set “Display Language” to “Japanese.”

① When this item is set to “English,” “Display Language” is not displayed.

When you set the system language of the receiver to Japanese, the receiver has the capability to display both English and Japanese characters. HOWEVER, if you select Japanese, all menu items throughout the receiver system will be displayed in only Japanese characters. There will be no English item names. Unless you are fluent in reading Japanese characters, use this feature with extreme caution.

If you have changed the receiver’s language to Japanese and do not understand the menu system in the new setting, you will have to change the language back to English by doing a partial reset of the receiver CPU. A partial reset will not clear your memory channel databases.

To do a partial reset of the CPU, do the following steps:

1. Push [MENU].
2. Select “SET.”



3. Select the item (with the “etc” icon) shown below.

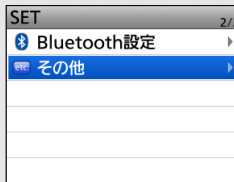

4. Select the bottom item shown below.



5. Select the upper item shown below.



① **DO NOT** select the lower item. The lower item is for the All reset function, and the All reset clears all entries and returns all settings to their factory defaults.

6. Select the upper option.

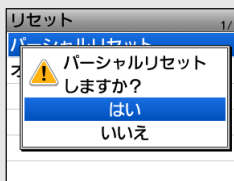

- When the partial reset is completed, “PARTIAL RESET” is displayed, then the display automatically returns to the default screen.

Sounds

Volume Select (Default: All)

[MENU] > SET > Sounds > **Volume Select**

Select whether or not to adjust the audio output level independently, according to the operating status.

- All: The audio output level of the FM Radio, A band (VFO A), and B band (VFO B) are adjusted at the same time.
- FM Radio Separate: The audio output level of the FM Radio is independently adjusted. The audio output level for A band (VFO A) and B band (VFO B) are adjusted at the same time.
- Separate: The audio output level for the FM Radio, A band (VFO A), and B band (VFO B) are independently adjusted.

Earphone Mode (Default: OFF)

[MENU] > SET > Sounds > **Earphone Mode**

Turns the earphone mode ON or OFF.

While in the earphone mode, the audio volume level is automatically adjusted to a comfortable level when the optional earphone is connected to the [R] jack.

Beep Level (Default: 8)

[MENU] > SET > Sounds > **Beep Level**

Sets the beep output level to 0 (OFF) or 1 (minimum) ~ 15 (maximum).

Beep/Vol Level Link (Default: OFF)

[MENU] > SET > Sounds > **Beep/Vol Level Link**

Selects whether or not the beep output level can be adjusted by rotating [VOL].

- OFF: The output level is fixed to the level set in "Beep Level."
- ON: The output level can be adjusted by rotating [VOL].

Key-Touch Beep (Default: ON)

[MENU] > SET > Sounds > **Key-Touch Beep**

Turns the confirmation beep ON or OFF.

- OFF: No beep sounds.
- ON: A beep sounds when you push a key.

Scan Stop Beep (Default: OFF)

[MENU] > SET > Sounds > **Scan Stop Beep**

Turns the Scan Stop Beep ON or OFF.

- OFF: No beep sounds.
- ON: A beep sounds when a scan stops by receiving a signal.

Sub Band Mute (Default: OFF)

[MENU] > SET > Sounds > **Sub Band Mute**

Selects whether or not to mute the SUB band audio signal while receiving on the MAIN band and/or sound a beep when a signal disappears on the SUB band.

- OFF: Turns OFF the function.
- Mute: While receiving on the MAIN band, the SUB band audio signal is muted.
- Beep: A beep sounds when a signal disappears on the SUB band.
- Mute & Beep: The SUB band audio signal is muted while receiving on the MAIN band. When a signal disappears on the SUB band, a beep sounds.

① When you set this item to "Beep" or "Mute & Beep," a beep sounds, even if no signal is received on the MAIN band.

Time Set

DATE

[MENU] > SET > Time Set > Date/Time > **DATE**

Manually set the date to between 2020/01/01 and 2099/12/31.

① The day of the week is automatically set.

TIME

[MENU] > SET > Time Set > Date/Time > **TIME**

Manually set the time that is displayed at the top of the screen. The time is displayed in the 24 hour format.

① CS-R15 PROGRAMMING SOFTWARE (purchase separately) can automatically set the time.

SD Card

Load Setting

[MENU] > SET > SD Card > **Load Setting**

Selects the saved data file to load.

Save Setting

[MENU] > SET > SD Card > **Save Setting**

Saves the setting data onto a microSD card.

Import

[MENU] > SET > SD Card > Import/Export > **Import**

Imports the Memory channel contents and Radio memory contents in the CSV format file.

Export

[MENU] > SET > SD Card > Import/Export > **Export**

Exports the Memory channel contents and Radio memory contents in the CSV format file.

Separator/Decimal (Default: Sep[,] Dec[.])

[MENU] > SET > SD Card > Import/Export > CSV Format > **Separator/Decimal**

Selects the separator and the decimal character for the CSV format.

① The default value may differ, depending on the receiver version.

- Sep [,] Dec [.]: Separator is “,” and Decimal is “.”
- Sep [;] Dec [.]: Separator is “;” and Decimal is “.”
- Sep [;] Dec [,]: Separator is “;” and Decimal is “,”

Opening Picture

[MENU] > SET > SD Card > **Opening Picture**

Selects the picture that is displayed at power ON.

① See page 8-7 for details.

SD Card Info

[MENU] > SET > SD Card > **SD Card Info**

Displays the microSD card capacity and the time remaining for voice recording.

Screen Capture View

[MENU] > SET > SD Card > **Screen Capture View**

Displays the selected screen capture.

Firmware Update

[MENU] > SET > SD Card > **Firmware Update**

Displays the Firmware Update mode.

Format

[MENU] > SET > SD Card > **Format**

Formats the microSD card.

If you use a brand new microSD card, be sure to format it in the receiver.

Unmount

[MENU] > SET > SD Card > **Unmount**

Unmounts the microSD card.

Before you remove a card when the receiver is ON, be sure to electrically unmount it. Otherwise, the data may be corrupted or deleted.

Bluetooth Set

Bluetooth (Default: OFF)

[MENU] > SET > Bluetooth Set > **Bluetooth**

Turns the Bluetooth function ON or OFF.

<<Pairing>>

[MENU] > SET > Bluetooth Set > **Pairing**

Searches for a Bluetooth device to connect or display the paired Bluetooth devices in the list.

① See the Basic manual Section 7 for details.

AF Output (Default: Headset Only)

[MENU] > SET > Bluetooth Set > Headset Set > **AF Output**

Selects the AF Output device when a Bluetooth headset is connected.

- Headset Only: Outputs audio to only the connected Bluetooth headset.
- Headset & Speaker:
Outputs audio to both the connected Bluetooth headset and the receiver's speaker.

Auto Disconnect (Default: OFF)

[MENU] > SET > Bluetooth Set > Headset Set > **Auto Disconnect**

Sets whether or not to automatically disconnect the bonded Bluetooth device when there is no audio output from the Bluetooth headset and the receiver is not operated.

- OFF: Does not disconnect from the bonded device.
- 0 ~ 10 sec: Automatically disconnects the bonded device after a set period of time without any receiver operation or audio output by the device.

① The connection automatically resumes when an audio signal is received, a beep sounds, or the receiver is operated.

Bluetooth Device Information

[MENU] > SET > Bluetooth Set > **Bluetooth Device Information**

Displays the Bluetooth device information.

Initialize Bluetooth Device

[MENU] > SET > Bluetooth Set > **Initialize Bluetooth Device**

Initializes the installed Bluetooth unit.

Others

Battery

[MENU] > SET > Others > Information > **Voltage**

Displays the voltage of the battery pack and external power source.

- ① When you attach the Li-ion battery pack, the charge status of the battery pack and the battery voltage are displayed.
- ① When you attach the optional battery case, the battery case's terminal voltage is displayed.

Version

[MENU] > SET > Others > Information > **Version**

Displays the receiver firmware's version number.

Clone Mode

[MENU] > SET > Others > Clone > **Clone Mode**

Enters the clone mode to read or write the CS-R15 data from or to the PC.

① Restart the receiver to cancel the clone mode.

Partial Reset

[MENU] > SET > Others > Reset > **Partial Reset**

Resets operating settings to their default values (VFO frequency, VFO settings, menu contents).

① See page 15-18 for details.

All Reset

[MENU] > SET > Others > Reset > **All Reset**

Clears all data and returns all settings to their factory defaults.

Memory channel contents and so on will all be cleared, so you will need to rewrite your operating settings.

① See page 15-18 for details.

Section 8 OTHER FUNCTIONS

NOTE: See the Basic manual Section 6 for details on how to insert or remove a microSD card and precautions.

Favorite channel mode	8-2
◇ Setting Favorite channels	8-2
◇ Entering the Favorite mode	8-2
Tone squelch operation	8-3
◇ Tone squelch frequency setting	8-3
Duplex operation	8-4
◇ Frequency offset	8-4
◇ Setting the Duplex direction and frequency offset	8-4
Weather channel operation (For only the USA version)	8-5
◇ Selecting a Weather channel	8-5
◇ Weather Alert function	8-5
Screen Capture function	8-6
◇ Setting the Screen Capture function	8-6
◇ Capturing a screen	8-6
◇ Viewing the captured screen	8-6
Setting the Opening picture	8-7
Cloning	8-8
Resetting	8-9
◇ Partial Reset	8-9
◇ All Reset	8-9

Favorite channel mode

You can quickly recall often-used channels by setting them as Favorite channels.

◇ Setting Favorite channels

1. In the memory mode, select a channel you want to add to Favorites.
2. Push [QUICK].
3. Select “Add to Favorites.”

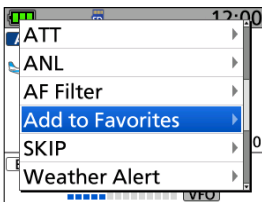

4. Select “ON.”
 ⓘ To cancel from Favorites, select “OFF.”

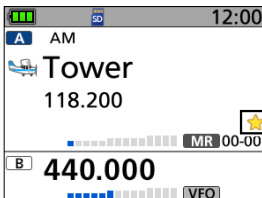
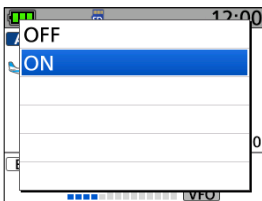

- ★ is displayed.

TIP: You can also confirm Favorite channels from the Memory channel.

- ⓘ To add to the Favorites, push [QUICK] and select “Add to Favorites.”

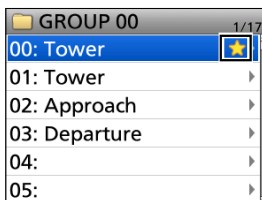

- ★ is displayed.

◇ Entering the Favorite mode

1. In the memory mode, push [QUICK].
2. Select “Favorite Mode.”

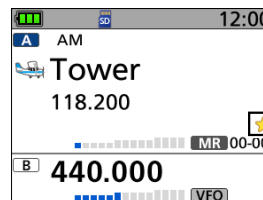
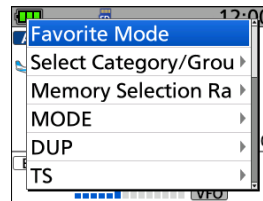

- “Favorite Select Mode” is displayed and then ★ is displayed on the standby screen.

ⓘ Information

- Individually selectable for the A band and B band.
- When you rotate [DIAL], you can select only the channels you have entered as Favorites.
- To exit the Favorite mode, push [QUICK] and select “Exit Favorite Mode.”

Tone squelch operation

The tone squelch opens only when you receive a signal that includes a matching subaudible tone or DTCS code in the FM or FM narrow (FM-N) mode. Also, the reversed tone squelch function mutes the squelch when a signal including a matching subaudible tone or DTCS code.

◆ Tone squelch frequency setting

1. In the VFO mode, push [QUICK].
2. Select "TONE."

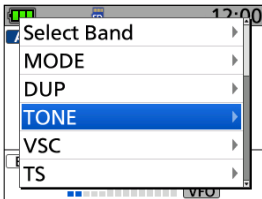

3. Select the Tone Squelch type.

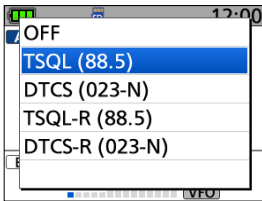

4. Rotate [DIAL] to set a Tone Squelch frequency or DTCS code, and then push [ENT].

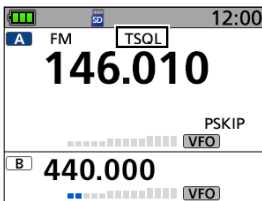
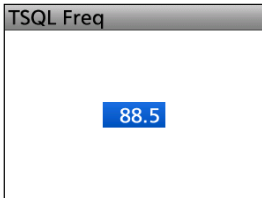

- The selected Tone Squelch type is displayed.
- ① You can select the DTCS code polarity from "Normal" or "Reverse" by moving cursor and rotating [DIAL].

Tone Frequency (Hz)

67.0	88.5	114.8	151.4	177.3	203.5	250.3
69.3	91.5	118.8	156.7	179.9	206.5	254.1
71.9	94.8	123.0	159.8	183.5	210.7	
74.4	97.4	127.3	162.2	186.2	218.1	
77.0	100.0	131.8	165.5	189.9	225.7	
79.7	103.5	136.5	167.9	192.8	229.1	
82.5	107.2	141.3	171.3	196.6	233.6	
85.4	110.9	146.2	173.8	199.5	241.8	

DTCS Code

023	054	125	165	245	274	356	445	506	627	732
025	065	131	172	246	306	364	446	516	631	734
026	071	132	174	251	311	365	452	523	632	743
031	072	134	205	252	315	371	454	526	654	754
032	073	143	212	255	325	411	455	532	662	
036	074	145	223	261	331	412	462	546	664	
043	114	152	225	263	332	413	464	565	703	
047	115	155	226	265	343	423	465	606	712	
051	116	156	243	266	346	431	466	612	723	
053	122	162	244	271	351	432	503	624	731	

Duplex operation

The Duplex operation shifts the transmit frequency up or down from the receive frequency by an offset. You can receive communication that uses different frequencies for transmitting and receiving (Duplex), by setting the frequency offset and shift direction.

While the [SQL] (monitor) key is held down, the displayed frequency automatically changes to the transceiver transmit frequency.

When the Duplex direction is set to “DUP+,” the transmit frequency shifts up from the receive frequency by the offset amount.

When the Duplex direction is set to “DUP-,” the transmit frequency shifts down from the receive frequency by the offset amount.

◇ Frequency offset

The receive frequency shifts according to the set frequency offset and direction, while holding down [SQL]. You can set the frequency offset and direction in the QUICK menu.

Marine VHF band access image

Example: Receiving on CH 5 in the International group

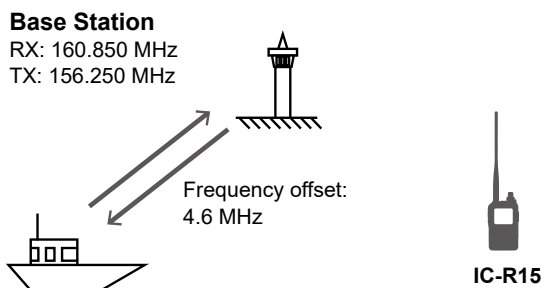

Ship station

RX: 156.250 MHz
TX: 160.850 MHz

You need to set the Duplex direction and frequency offset to receive communications as shown above.

When the receive frequency of IC-R15 is set to 156.250 MHz, set it to “DUP+.”

◇ Setting the Duplex direction and frequency offset

1. Push [QUICK].
2. Select “DUP.”

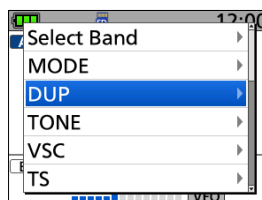

3. Select the Duplex direction.
 - OFF: Receives simplex communications.
 - DUP-: When you activate the Monitor function, the receive frequency is shifted down by the offset amount and you receive duplex communications.
 - DUP+: When you activate the Monitor function, the receive frequency is shifted up by the offset amount and you receive duplex communications.

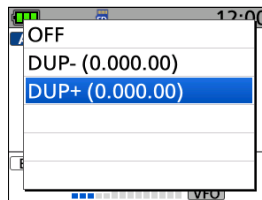

4. Rotate [DIAL] to set the offset.

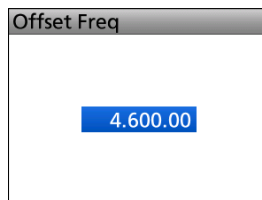

- Set to between 0.000.00 and 159.999.99 MHz.
 - ① The selected tuning step in the VFO mode is used to set the offset.
 - ② 5.000 MHz is set as the default on the 430 MHz band.
5. Push [ENTER].
 - “D-” or “D+” is displayed.

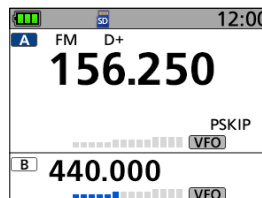

6. Hold down [SQL].
 - The Monitor function is ON. The receive frequency is shifted while [SQL] is hold down.

TIP: During a Memory scan, not only the set frequency, but also the offset frequency is scanned if Duplex is set to the channel.
 ([MENU] > SET > Scan > **DUP Check During MR Scan**)

Weather channel operation (For only the USA version)

There are 10 weather channels for monitoring the National Oceanographic and Atmospheric Administration (NOAA) weather broadcasts.

① The Weather channel and the Weather Alert function are not usable in Simple mode.

◇ Selecting a Weather channel

1. Push [MR] to enter the Weather Channel mode.
 - ① Pushing [MR] each time toggles the Memory and Weather Channel modes.

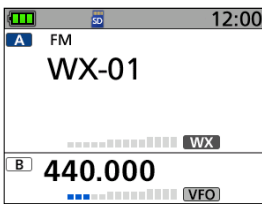

2. Rotate [DIAL] to select a Weather channel.
 - Displays the selected Weather channel number ("WX-01" ~ "WX-10").

◇ Weather Alert function

NOAA broadcast stations transmit weather alert tones before important weather announcements.

When the Weather Alert function is turned ON, the selected Weather channel is monitored every 5 seconds for an announcement.

When an alert signal is detected, the "ALT" and the WX channel are alternately displayed, and a beep sounds until you change the mode or Weather channel, turn OFF the Weather Alert function, or turn OFF the receiver.

The previously selected (used) Weather channel is checked periodically during standby, or while scanning.

1. Push [QUICK].
2. Select "Weather Alert."

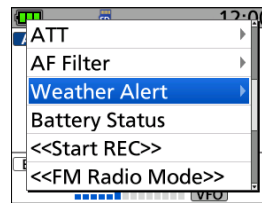

3. Select "ON."

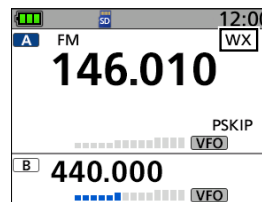
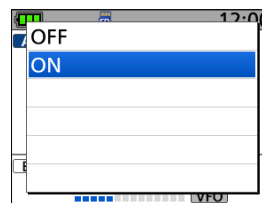

- Turns ON the Weather Alert function, and "WX" is displayed.

Screen Capture function

You can capture the receiver display onto a microSD card. Most of the screens used in this manual are captured using this function. However, some displays cannot be captured.

◇ Setting the Screen Capture function

[MENU] > SET > Function >
Screen Capture [PWR] Key

1. Push [MENU].
2. Select "Function" in the "SET" menu.
3. Select "Screen Capture [PWR] Key."

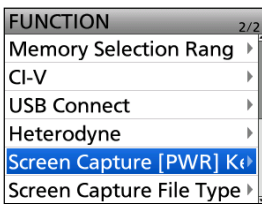

4. Select "ON."

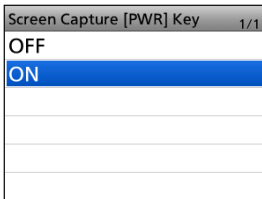

① To exit the MENU screen, push [MENU].

◇ Capturing a screen

1. Display the desired screen to capture.
2. Push [PWR] to capture the screen.
 - The captured screen is saved onto the microSD card.

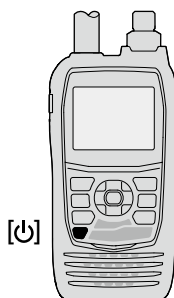

◇ Viewing the captured screen

[MENU] > SET > SD Card > Screen Capture View

1. Push [MENU].
2. Select "SD Card" in the "SET" menu.
3. Select "Screen Capture View."

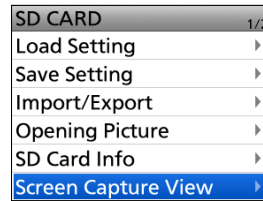

- The capture list is displayed.
 - The latest screen capture is at the bottom of the list.
4. Select the desired screen capture to display it.

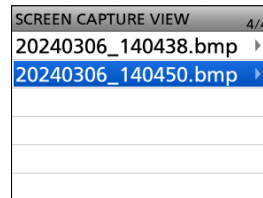

- The screen capture is displayed.
- ① While a screen capture is displayed, you can scroll through all the screen captures by rotating [DIAL].
- ① To exit the MENU screen, push [MENU].

Checking the file information and deleting a file:

1. Select the screen capture that you want to view or delete.
 - ① **DO NOT** push [ENT].
2. Push [QUICK].
3. Select an item from "File Information," "Delete," and "Delete All."

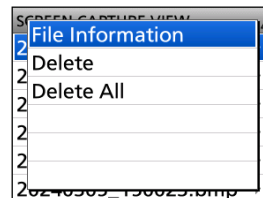

- **File Information:** Displays the file name, size, and date of the selected screen capture.
- **Delete:** Deletes the selected file.
- **Delete All:** Deletes all files.

Setting the Opening picture

You can set a picture that is displayed at power ON.

NOTE: To set the displayed picture, a microSD card (user supplied) is required.

About a picture file to use

- File type: 24 bit bitmap
(The file extension is “bmp.”)
- Picture size: 296 x 222 (px)
- File name: Up to 20 characters
(except the filename extension)
- Number of files: 100

Step 1. Saving a picture on the microSD card (PC)

1. Copy a picture file into the “OpeningPicture” folder (“IC-R15” > “OpeningPicture”) on the microSD card.
① See page 2-5 for details.
2. Insert the microSD card into the receiver.

Step 2. Setting the displayed picture (Receiver)

[MENU] > SET > SD Card > **Opening Picture**

1. Push [MENU].
2. Select “SD Card” in the “SET” menu.
3. Select “Opening Picture.”

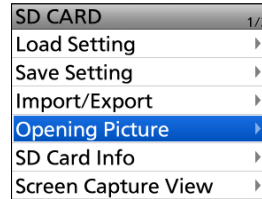

4. Select a picture to display.

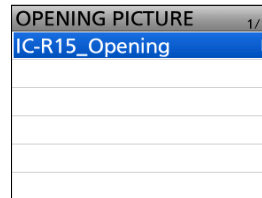

- The selected picture is displayed.
5. Push [ENT].
① To select the picture again, push [CLEAR].
 - The confirmation dialog is displayed.
 6. Select “YES.”
 - The receiver will automatically restart, and the selected picture is displayed.

To hide the picture at power ON

Select “<<Cancel Opening Picture Setting>>” in step 4.

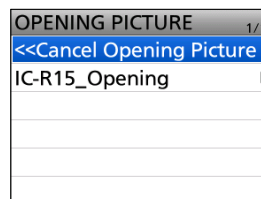

- ① The selected picture can be displayed even if:
- No microSD card is inserted.
 - You do a Partial Reset or All Reset.

Cloning

The receiver has a data cloning capability. This function is useful when you want to copy all of the settings and entered contents from one IC-R15 to another. This section describes the cloning method using a microSD card.

- ① Recorded voice memories are not included in the cloning data. To play back the master receiver's voice memory, insert the microSD card into a sub receiver, or make a copy onto the sub receiver's microSD card using a PC.
- ① Assumes that the microSD card has already been inserted into the receiver.

Step 1. Saving the master receiver's setting data onto the microSD card.

[MENU] > SET > SD Card > **Save Setting**

① See page 2-2 for details.

Step 2. Remove the microSD card from the master receiver, then insert it into the sub receiver.

1. Turn OFF the master receiver.
2. Remove the microSD card from the master receiver.
3. Insert the card into the sub receiver, then turn ON the sub receiver.

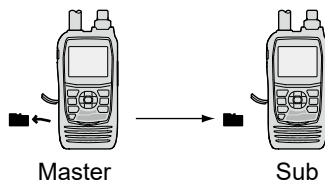

NOTE:

- Turn OFF the receiver before you insert or remove the microSD card.
- **DO NOT** turn OFF the receiver while saving or loading the setting data. Otherwise, the data may be corrupted or deleted.

TIP: The setting data is saved in the "icf" file format that is used in the CS-R15 PROGRAMMING SOFTWARE (purchase separately). When the saved data on a card is copied to a PC, you can edit it with the programming software. For details, refer to the CS-R15 instructions that comes with the software.

Step 3. Loading the setting data into the sub receiver.

[MENU] > SET > SD Card > **Load Setting**

① See page 2-4 for details.

Resetting

Occasionally, erroneous information may be displayed. This may be caused by static electricity or by other factors.

If this problem occurs, turn OFF the receiver. After waiting a few seconds, turn ON the receiver again.

If the problem still exists, perform a **Partial reset**.

If the problem still exists after performing a Partial reset, perform an **All reset**.

◇ Partial Reset

A Partial Reset resets the operating settings to their defaults without clearing the following:

- Memory Channel contents
- Radio Memory contents
- Scan Edge contents
- Opening picture

[MENU] > SET > Others > Reset > **Partial Reset**

1. Push [MENU].
2. Select "Others" in the "SET" menu.
3. Select "Reset."

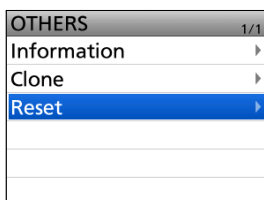

4. Select "Partial Reset."

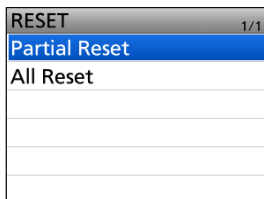

- The confirmation dialog is displayed.

5. Select "YES."

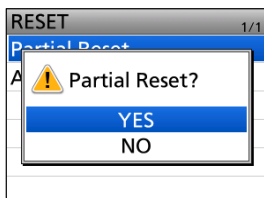

- "PARTIAL RESET" is displayed, and then the display automatically returns to the default screen.

◇ All Reset

NOTE: An All reset clears all data and returns all settings to the factory defaults. Memory channel contents, setting status, and so on will all be cleared, so you will need to rewrite your operating settings unless you have a backup.

① The Bluetooth pairing list and the Opening picture are not cleared by an All reset.

[MENU] > SET > Others > Reset > **All Reset**

1. Push [MENU].
2. Select "Others" in the "SET" menu.
3. Select "Reset."

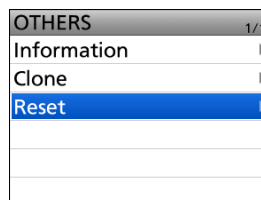

4. Select "All Reset."

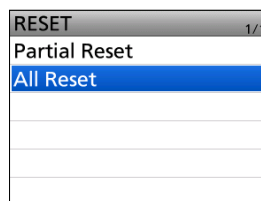

- The confirmation dialog is displayed.

5. Select "YES."

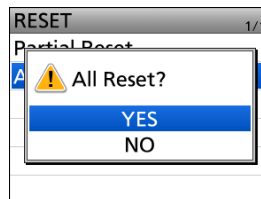

- "ALL RESET" is displayed, and then the display automatically returns to the default screen.

Section 9

UPDATING THE FIRMWARE

NOTE: See the Basic manual Section 6 for details on how to insert or remove a microSD card and precautions.

General.....	9-2
◇ About updating the firmware	9-2
◇ Checking the firmware version	9-2
◇ Preparation	9-3
Updating the firmware	9-4

General

◇ About updating the firmware

You can update the receiver's firmware using a microSD card. Updating the firmware adds new functions and/or improves performance parameters. You can download the latest firmware from the Icom website.

<https://www.icomjapan.com/support/>

IMPORTANT: To update the firmware, first format your microSD card using the receiver. Then, copy the downloaded firmware data from your PC into the "IC-R15" folder on the card.

◇ Checking the firmware version

Check the firmware version on the VERSION screen.

[MENU] > SET > Others > Information > **Version**

1. Push [MENU].
2. Select "Others" in the "SET" menu.
3. Select "Information."

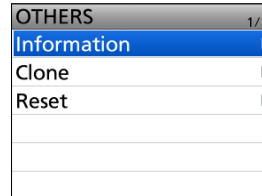

4. Select "Version."

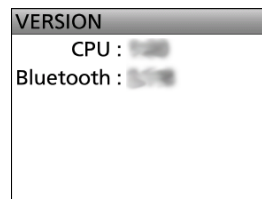
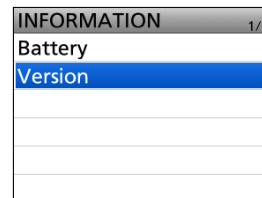

- The VERSION screen is displayed.
- ① To exit the VERSION screen, push [MENU].

TIP: You can also check the firmware version when you turn ON the receiver.



The firmware version is displayed.

General

◇ Preparation

Access the following URL and download the firmware file.

<https://www.icomjapan.com/support/>

① These instructions are based on Microsoft Windows 11.

1. Click the “Firmware/Software” link.

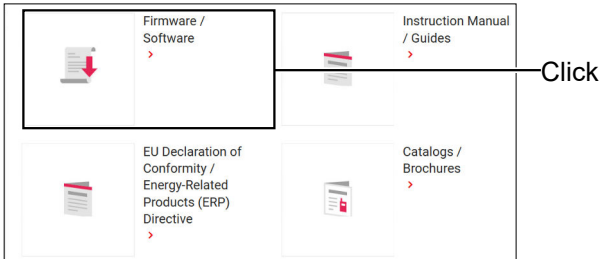

2. Enter “IC-R15” into the Search box, and then click [Search].

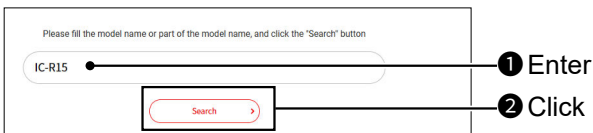

3. Click the desired firmware file link.
4. Carefully read “Regarding this Download Service.” Click “I have read, fully understood and agree the above.” and then click [Download].
 - The file starts downloading.

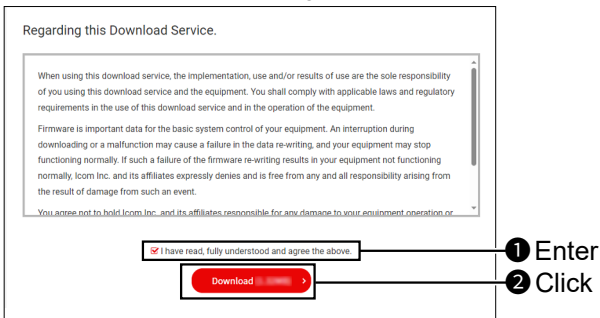

5. After the download is complete, click “Open file.”
 - ① Download steps may differ depending on the PC settings.

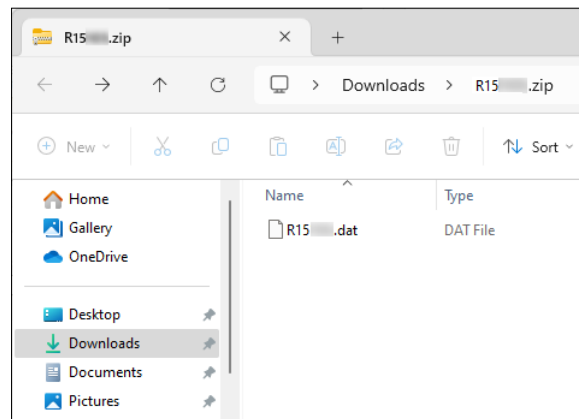

- In the “R15*” folder, “R15*.dat” is created.
- * Represents the release number.

Updating the firmware

CAUTION: NEVER turn OFF the receiver while updating the firmware. If you turn OFF the receiver, or if a power failure occurs while updating, the receiver firmware may be damaged, and if so, you will have to send the receiver back to the nearest Icom distributor for repair. This type of repair is out of warranty, even if the receiver warranty period is still valid.

Recommendation!
Fully charging the battery pack before starting the firmware update is strongly recommended. This is to avoid failure during the update, caused by an unexpected power failure.

1. Copy the downloaded firmware data into the "IC-R15" folder onto a microSD card.

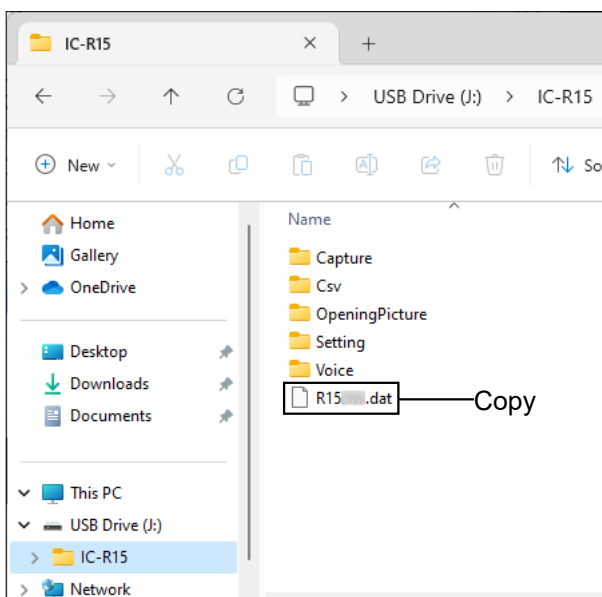

2. Insert the microSD card into the receiver.
3. Display the SD CARD screen.

[MENU] > SET > SD Card

4. Select "Firmware Update."

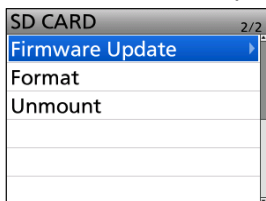

5. After you read and agree with all the precautions, select "YES."

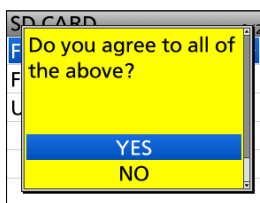
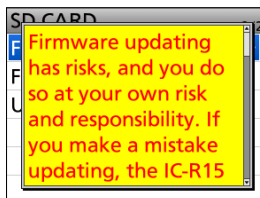

- Scroll the screen and read all the precautions.
- The confirmation dialog is displayed. When you select "YES," the backup file is made on the microSD card, and then the Firmware selection screen is displayed.

6. Select the Firmware (Example: R15*).
* Represents the release number.

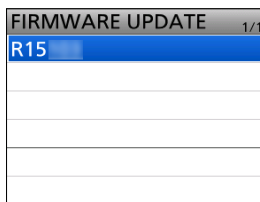

- The final confirmation screen is displayed. Carefully read all the displayed precautions.

7. After you read and agree with all the precautions, select "YES."

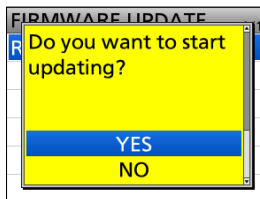

- The updating starts.

8. When the update is completed, "Firmware updating has completed." is displayed in the dialog.

- The receiver will automatically restart.
- ① After the updating finishes, the Standby screen is displayed.

TIP: When "USB Connect" is set to "SD Card Mode," and the receiver is connected to the PC through a USB data cable, you can directly access the microSD card that is set in the receiver from the PC. ([MENU] > SET > Function > **USB Connect**)

Section 10 OPTIONS

Option list.....10-2

Option list

You can find information for these options on the Icom website.

<https://www.icomjapan.com/support/>

① Some options may not be available, depending on the receiver version.

Batteries/Charger

BC-223 BATTERY CHARGER

The shape may be different, depending on the charger version.

BP-287 Li-ion BATTERY PACK

Voltage: 3.6V

Discharge capacity: 3120 mAh (minimum), 3280 mAh (typical)

BP-293 BATTERY CASE

Uses 3 LR6 (AA) alkaline batteries.

Earphone

SP-40 EARPHONE

Cable

BC-258A/BC-258E/BC-258V AC ADAPTER

AC adapter for charging.

Others

FA-S270C VHF/UHF ANTENNA

The same as supplied.

LC-203 CARRYING CASE

① You cannot use when the BP-293 is attached to the receiver.

MB-127 BELT CLIP

The same as supplied.

CS-R15 PROGRAMMING SOFTWARE

