



INSTRUCTION MANUAL

COMMUNICATIONS RECEIVER
IC-R2

This device complies with Part 15 of the FCC rules. Operation is subject to the following two conditions: (1) This device may not cause harmful interference, and (2) this device must accept any interference received, including interference that may cause undesired operation.

Icom Inc.

FOREWORD

READ ALL INSTRUCTIONS carefully and completely before using the receiver.

SAVE THIS INSTRUCTION MANUAL — This instruction manual contains important operating instructions for the IC-R2.

EXPLICIT DEFINITIONS

The explicit definitions below apply to this instruction manual.

WORD	DEFINITION
⚠ WARNING	Personal injury, fire hazard or electric shock may occur.
CAUTION	Equipment damage may occur.
NOTE	If disregarded, inconvenience only. No risk of personal injury, fire or electric shock.

 Versions of the IC-R2 which display "CE" on the serial number seal, comply with the essential requirements of the 89/336/EEC directive for Electromagnetic Compatibility.

CAUTIONS

⚠ WARNING! NEVER operate the receiver with a headset or other audio accessories at high volume levels. Hearing experts advise against continuous high volume operation. If you experience a ringing in your ears, reduce the volume level or discontinue use.

AVOID using or placing the receiver in direct sunlight or in areas with temperatures below -10°C ($+14^{\circ}\text{F}$) or above $+60^{\circ}\text{C}$ ($+140^{\circ}\text{F}$).

Even when the receiver power is OFF, a slight current still flows in the circuits. Remove batteries from the receiver when not using it for a long time. Otherwise, the installed batteries will become exhausted.

For U.S.A. only

CAUTION: Changes or modifications to this device, not expressly approved by Icom Inc., could void your authority to operate this device under FCC regulations.

SUPPLIED ACCESSORIES

Accessories included with the receiver:	Qty.
① Antenna (FA-S270C)	1
② Handstrap	1
③ Belt clip	1
④ Ni-Cd charger (BC-127A/D) and 2 Ni-Cd batteries .. 1 set*	

*Not supplied with some versions.

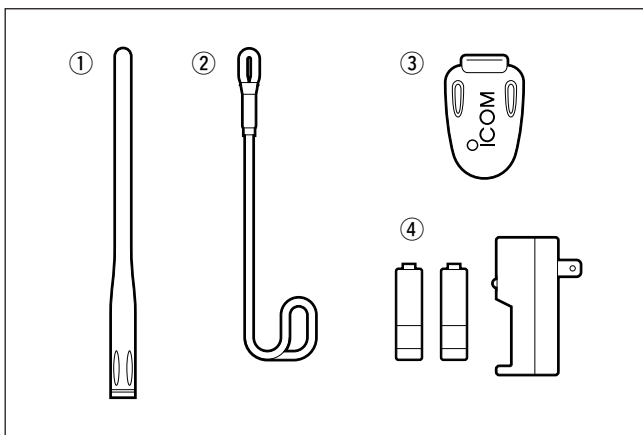

OPERATING THEORY

Electromagnetic radiation which has frequencies of 20,000 Hz (20 kHz*) and above is called radio frequency (RF) energy because it is useful in radio transmissions. The IC-R2 receives RF energy from 0.495 MHz* to 1309.995 MHz and converts it into audio frequency (AF) energy which in turn actuates a loudspeaker to create sound waves. AF energy is in the range of 20 to 20,000 Hz.

*kHz is an abbreviation of kilohertz or 1000 hertz, MHz is abbreviation of megahertz or 1,000,000 hertz, where hertz is a unit of frequency.

OPERATING NOTES

The IC-R2 may receive its own oscillated frequency, resulting in no reception or only noise reception, on some frequencies.

The IC-R2 may receive interference from extremely strong signals on different frequencies or when using an external high-gain antenna.

TABLE OF CONTENTS

FOREWORD	i	■ Monitor function	10	8 SUBAUDIBLE TONE	
EXPLICIT DEFINITIONS	i	■ Receive mode selection	11	OPERATION	22–23
CAUTIONS	i	■ Display backlighting	11	■ Tone squelch operation	22
SUPPLIED ACCESSORIES	ii	5 MEMORY CHANNELS	12–14	■ Pocket beep operation	23
OPERATING THEORY	ii	■ General	12	■ Tone scan	23
OPERATING NOTES	ii	■ Programming during selection	12	9 DUPLEX OPERATION	24
TABLE OF CONTENTS	iii	■ Programming after selection ...	13	10 OTHER FUNCTIONS	25–30
1 ACCESSORY ATTACHMENT	1	■ Transferring memory contents		■ Set mode	25
2 PANEL DESCRIPTION	2–5	to another memory	13	■ Dial select step	26
■ Panel description	2	■ Memory bank selection	14	■ Beep tones	26
■ Function display	4	■ Memory clear	14	■ Power saver	26
3 FREQUENCY AND CHANNEL		6 SCAN OPERATION	15–19	■ Auto power-off function	27
SETTING	6–8	■ Scan types	15	■ Monitor switch action	27
■ VFO and memory channels	6	■ Full/band/programmed scan ...	16	■ Dial speed acceleration	28
■ Operating band selection	6	■ Memory (bank) scan	16	■ Lock function effect	28
■ Setting a frequency	7	■ Selecting scan edges	17	■ Channel indication mode	29
■ Setting a tuning step	7	■ Skip channel setting	18	■ Cloning function	29
■ Selecting a memory channel	8	■ Scan resume condition	18	■ Partial reset	30
■ Lock function	8	■ Frequency skip function	19	■ All reset	30
■ Attenuator function	8	7 PRIORITY WATCH	20–21	11 TROUBLESHOOTING	31
4 BASIC OPERATION	9–11	■ Priority watch types	20	12 OPERATION FLOW CHART..	32–33
■ Receiving	9	■ Priority watch operation	21	13 SPECIFICATIONS AND	
■ Setting volume level	10			OPTIONS	34–35
■ Setting squelch level	10				

ACCESSORY ATTACHMENT

1

◇ Antenna

Insert the supplied antenna into the antenna connector and screw down the antenna as shown at right.

Keep the jack cover attached when jack is not in use to avoid bad contacts from dust and moisture.

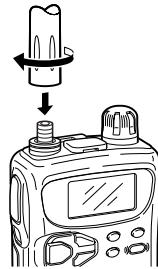

Commercially available antennas may increase receiver performance. An optional AD-92SMA ANTENNA CONNECTOR ADAPTER is available to connect an antenna with a BNC connector.

◇ Battery installation

① Remove the battery cover from the receiver.

② Install 2 R6 (AA) size alkaline, dry cell or Ni-Cd batteries.

- Be sure to observe the correct polarity.
- Charge Ni-Cd batteries before use. (See the separate BC-127A/D instruction sheet.)

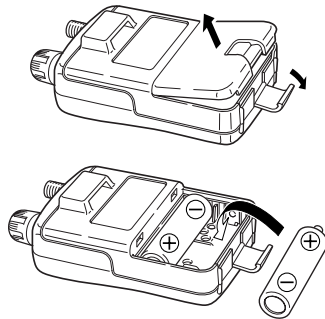

Keep battery contacts clean. It's a good idea to clean battery terminals once a week.

◇ Belt clip

Conveniently attaches to your belt.

Slide the belt clip into the plastic loop on the back of the receiver.

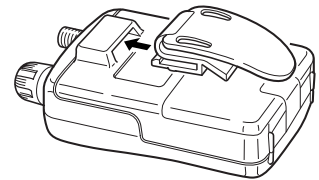

◇ Handstrap

Slide the handstrap through the loop on the side of the belt clip as illustrated at right. Facilitates carrying.

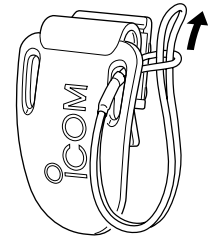

2

PANEL DESCRIPTION

■ Panel description

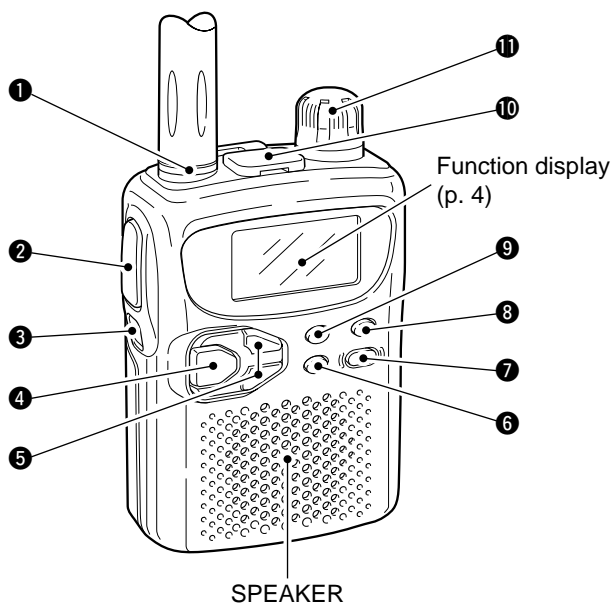

① ANTENNA CONNECTOR (p. 1)

Connects the supplied antenna.

- An optional AD-92SMA is available for connecting an antenna with a BNC connector.

② MONITOR SWITCH [SQL] (pgs. 10, 27)

- ➔ Push and hold to temporarily open the squelch and monitor the operating frequency. (default behaviour)
- ➔ While pushing, rotate the tuning dial to set the squelch threshold level.
- ➔ Push [FUNC] + [SQL] to toggle the attenuator circuit ON and OFF.

③ FUNCTION SWITCH [FUNC]

While pushing this switch, other switches and tuning dial perform secondary functions.

- “Push [FUNC] + a switch” means “while pushing the [FUNC] switch, push the switch.”

④ BAND SWITCH [BAND]

- ➔ Push to select the operating band (VHF, UHF, etc.). (p. 6)
 - Broadcast band, HF band, 50 MHz band, VHF avionics band, 144 MHz band, 300 MHz band, 400 MHz band, 800 MHz band and 1200 MHz band can be selected.
 - While pushing this switch, rotating [DIAL] also selects the operating band.
- ➔ Transfers the displayed frequency to the VFO in memory mode. (p. 6)
- ➔ Push [FUNC] + [BAND] to enter the scan edge set mode in VFO mode. (p. 17)
- ➔ Push [FUNC] + [BAND] to enter the bank scan set mode in memory mode. (p. 16)

5 VOLUME CONTROL SWITCHES [VOL ▲]/[VOL ▼]

- ➔ Push to adjust the audio level. (p. 10)
- ➔ Push [FUNC] + either switch to start a scan. (p. 16)
- ➔ Push [FUNC] + either switch for 2 sec. to start a tone scan. (p. 23)

6 VFO/MEMORY SWITCH [V/M (MW)]

- ➔ Toggles between VFO and memory modes. (p. 6)
- ➔ Enters set mode when pushed for 2 sec. (p. 25)
- ➔ Push [FUNC] + [(V/M)MW] to enter memory write mode. (p. 12)
- ➔ Push [FUNC] + [(V/M)MW] for 1 sec. to write the operating frequency into the selected memory channel in VFO mode. Keep pushing for 2 sec. or more to automatically select the next memory channel, if desired. (p. 12)
- ➔ Push [FUNC] + [(V/M)MW] for 1 sec. to write the displayed frequency into the VFO in memory mode. (p. 13)

7 POWER SWITCH [POWER]

Push for 2 sec. to toggle the receiver power ON and OFF.

8 TUNING STEP/MEMORY SKIP SWITCH [TS (SKIP)]

- ➔ Enters tuning step set mode. (p. 7)
- ➔ Push [FUNC] + [(TS)SKIP] to toggle the frequency skip function ON or OFF in VFO mode. (p. 19)
- ➔ Push [FUNC] + [(TS)SKIP] for 2 sec. to program the displayed frequency as a skip frequency during full, band or programmed scan. (p. 19)

- ➔ Push [FUNC] + [(TS)SKIP] to toggle the channel as skip, program skip or non-skip channel in memory mode. (p. 18)

9 MODE/LOCK SWITCH [MODE (LOCK)]

- ➔ Selects the receive mode. (p. 11)
- ➔ Push [FUNC] + [(MODE)LOCK] to toggle the lock function ON and OFF. (pgs. 8, 28)

10 EXTERNAL SPEAKER JACK [SP]

Connects an optional earphone or headphone. The internal speaker will not function when any external equipment is connected. (See p. 35 for a list of available options.)

11 TUNING DIAL [DIAL]

- ➔ Rotate [DIAL] to set operating frequencies, memory channels, set mode contents, etc. (p. 7)
- ➔ While scanning, changes the scanning direction. (p. 16)
- ➔ While pushing [SQL], sets the squelch level. (p. 10)
- ➔ While pushing [FUNC], sets the operating frequency in 100 kHz, 1 MHz or 10 MHz steps in VFO mode. (pgs. 7, 26)
- ➔ While pushing [FUNC], selects memory bank in memory mode. (p. 12)
- ➔ While pushing [BAND], selects the operating band in VFO mode. (p. 6)

2 PANEL DESCRIPTION

■ Function display

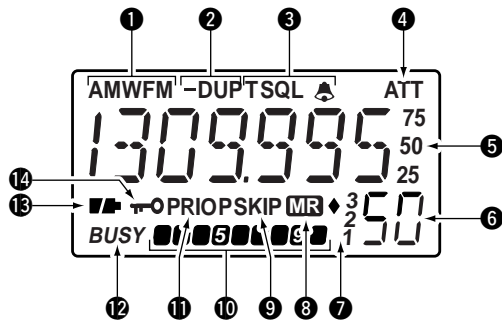

① RECEIVE MODE INDICATORS (p. 11)

Show the receive mode.

- AM, FM and WFM are available.

② DUPLEX INDICATORS (p. 24)

Appear when semi-duplex operation (repeater operation) is in use.

- “-DUP” appears when minus duplex is selected; “DUP” only, appears when plus duplex is selected.

③ TONE INDICATORS (p. 22)

- ↳ “T SQL” appears when the tone squelch function is activated and “T SQL 📞” appears during pocket beep operation.
- ↳ “📞” flashes when the correct tone is received during pocket beep operation.

④ ATTENUATOR INDICATOR

Appears when the attenuator function is in use. (p. 8)

⑤ FREQUENCY READOUT

Shows the operating frequency, set mode contents, etc.

- The smaller “75,” “50” and “25” to the right of the readout indicate 7.5, 5.0 and 2.5 kHz, respectively.
- The decimal point of the frequency flashes during scan.

⑥ MEMORY CHANNEL READOUT

Shows the memory channel number, etc.

⑦ MEMORY BANK INDICATORS

Indicate 8 memory banks.

- “1” – “3” indicate memory banks 1 to 3; “♦” indicates memory bank 4; “♦1” – “♦3” indicate memory banks 5 to 7; no bank indicator indicates memory bank 0.

⑧ MEMORY MODE INDICATOR

Appears when a memory channel is selected.

9 SKIP SCAN INDICATOR (p. 18)

- ➔ “SKIP” appears when a selected memory channel is set as a skip channel in memory mode.
- ➔ “P SKIP” appears when the skip frequency function is turned ON in VFO mode; or, when the selected memory channel is set to be skipped during VFO scan (full, band and programmed scan) in memory mode.

10 SIGNAL INDICATORS

Shows the relative signal strength while receiving.

11 PRIORITY WATCH INDICATOR (p. 20)

Appears when priority watch is in use.

12 BUSY INDICATOR

“BUSY” appears when receiving a signal or when the squelch is open.

13 BATTERY INDICATORS

- ➔ Both segments appear when the batteries have enough capacity.
- ➔ Only the right segment appears when the batteries are nearing exhaustion.
- ➔ Flash when battery replacement is necessary.

14 LOCK INDICATOR (p. 8)

Indicates that the lock function is in use.

3

FREQUENCY AND CHANNEL SETTING

■ VFO and memory channels

This receiver has 2 normal operating modes: VFO mode and memory mode.

VFO mode is used for setting a desired frequency within the frequency coverage.

➔ Push [V/M] to select VFO mode.



Memory mode is used for operation of memory channels which have programmed frequencies.

➔ Push [V/M] to select memory mode.

• To program a memory, refer to p. 12.



What is VFO?

VFO is an abbreviation of Variable Frequency Oscillator. Frequencies for receiving are generated and controlled by the VFO.

■ Operating band selection

The receiver can receive the broadcast band, HF band, 50 MHz band, VHF avionics band, 144 MHz band, 300 MHz band, 400 MHz band, 800 MHz band* or 1200 MHz band.

➔ Push [BAND] several times to select the desired band.

• When a memory channel is selected, the first push of [BAND] selects VFO mode (and transfers the memory channel contents).

➔ Rotate [DIAL] while pushing [BAND] to select the desired band.

▨ * Some frequencies cannot be received with the U.S.A. version.

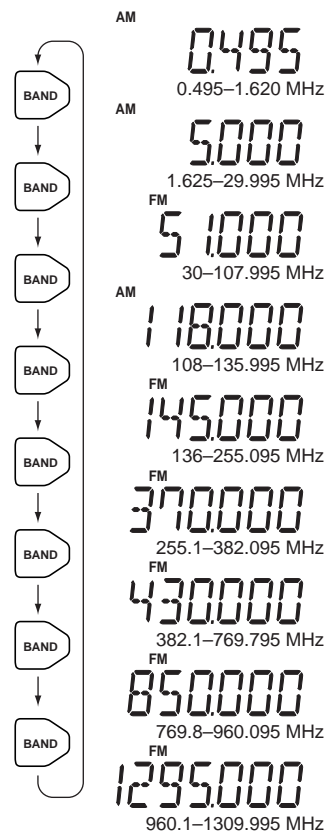

■ Setting a frequency

- ① Select VFO mode with [V/M].
- ② Select the desired band with [BAND].
- ③ Rotate [DIAL] to change the frequency.
 - The frequency changes according to the preset tuning steps. See the right section for selecting the tuning step.
 - Rotate [DIAL] while pushing [FUNC] to change the frequency in 1 MHz steps (default; p. 26).



[DIAL] changes the frequency according to the selected tuning step.



While pushing [FUNC], [DIAL] changes the frequency in 1 MHz steps (default).

/// The 1 MHz tuning step (dial select step) can be set to 100 kHz, 1 MHz or 10 MHz tuning steps in set mode. See p. 26 for details.

■ Setting a tuning step

Tuning steps can be selected for each band, however, the tuning step of the broadcast band is fixed to 9 kHz steps except for U.S.A. and Canada versions. The following are available.

- 5 kHz • 6.25 kHz • 10 kHz • 12.5 kHz • 15 kHz
- 20 kHz • 25 kHz • 30 kHz • 50 kHz • 100 kHz

◇ Using the [TS] switch

- ① Select VFO mode with [V/M].
- ② Select the desired band with [BAND].
- ③ Push [TS] to enter tuning step setting condition.
- ④ Rotate [DIAL] to select the desired tuning step.
- ⑤ Push [TS] to return to normal operation.



15 kHz tuning step

◇ Using set mode

- ① Select VFO mode with [V/M].
- ② Select the desired band with [BAND].
- ③ Push [V/M] for 2 sec. to enter set mode.
- ④ Rotate [DIAL] until "STEP" appears.
 - "STEP" disappears after 1 sec. and the previously selected tuning step and "tS" appear.
- ⑤ While pushing [FUNC], rotate [DIAL] to select the desired tuning step.
- ⑥ Push [V/M] to exit set mode.

3 FREQUENCY AND CHANNEL SETTING

■ Selecting a memory channel

- ① Push [V/M] to select memory mode.
 - "MEM" appears when a memory channel is selected.
- ② Rotate [DIAL] to change the indicated memory channel.
 - Only programmed memory channels can be selected.
 - Rotate [DIAL] while pushing [FUNC] to change the memory bank.

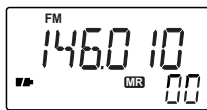

[DIAL] changes the memory channel.



While pushing [FUNC], [DIAL] changes the memory bank.

■ Lock function

The lock function prevents accidental frequency changes and accidental function access.

- ➡ Push [FUNC] + [(MODE)LOCK] to toggle the lock function ON and OFF.
- [POWER], [VOL] and [SQL] can still be accessed while the lock function is ON (default).
 - Accessible switches can be set to 1 of 4 groups in expanded set mode. See p. 28 for details.



"LO-O" appears when the lock function is in use.

■ Attenuator function

The attenuator prevents a desired signal from distorting when very strong signals are near the desired frequency or when very strong electric fields, such as from a broadcasting station, are near your location.

The attenuator has approx. 10 dB attenuation.

- ➡ Push [FUNC] + [SQL] to toggle the attenuator function ON and OFF.

Appears when the attenuator function is in use.



■ Receiving

Make sure charged Ni-Cd or alkaline batteries are installed.
(p. 1)

- ① Push [POWER] for 2 sec. to turn power ON.
- ② Push [VOL ▲] or [VOL ▼] to set the desired audio level.
 - The frequency display shows the volume level while setting. See the next page for details.
- ③ Set an operating frequency. (pgs. 6, 7)
- ④ Set the squelch level.
 - While pushing [SQL], rotate [DIAL].
 - The first click of [DIAL] indicates the current squelch level.
 - "LEVEL1" is loose squelch and "LEVEL9" is tight squelch.
 - "AUTO" indicates automatic level adjustment with a noise pulse count system.
 - Push and hold [SQL] to open the squelch manually.
- ⑤ When a signal is received:
 - ➔ Squelch opens and audio is emitted from the speaker.
 - ➔ The S/R/F indicator shows the relative signal strength.

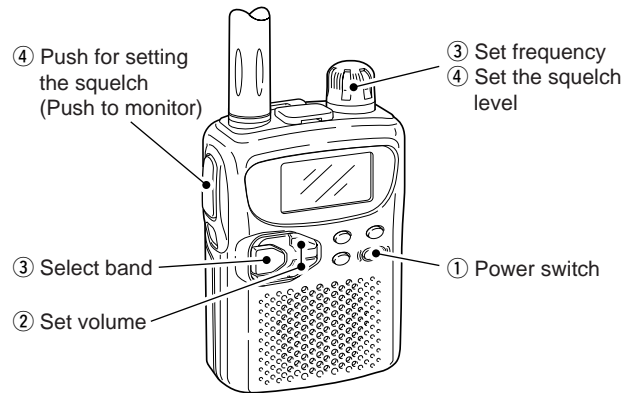

4 BASIC OPERATION

■ Setting volume level

The audio level can be adjusted through 32 levels.

- ➔ Push [VOL▲] or [VOL▼] to set the desired audio level.
 - Beep tone sounds while setting. This indicates the approximate sound level.
 - Pushing and holding these keys change the audio level continuously.
 - The frequency display shows the volume level while setting.

INDICATION	AUDIO LEVEL
-----	Min. setting (no audio)
0_-----	:
00_-----	Initial setting
000_-----	:
0000_-----	:
00000_-----	:
000000	Max. setting

■ Setting squelch level

The squelch circuit mutes the received audio signal depending on the signal strength. The receiver has 9 squelch levels, a continuously open setting and an automatic squelch setting.

- ➔ While pushing [SQL], rotate the [DIAL] to select the squelch level.
 - The first click of [DIAL] indicates the current squelch level.
 - “LEVEL1” is loose squelch and “LEVEL9” is tight squelch.
 - “AUTO” indicates automatic level adjustment with a noise pulse count system.
 - “OPEN” indicates continuously open setting.



Automatic squelch



Maximum level

■ Monitor function

This function is used to listen to weak signals or to open the tone squelch manually.

- ➔ Push and hold [SQL] to monitor the operating frequency.

▨ The [SQL] switch can be set to 'sticky' operation in expanded set mode. (p. 27)

■ Receive mode selection

Receive modes are determined by the physical properties of the radio signals. The receiver has 3 receive modes: FM, AM and WFM modes. The mode selection is stored independently in each band and memory channels.

Typically, AM mode is used for the AM broadcast stations (0.495–1.620 MHz) and air band (118–135.995 MHz), and WFM is used for FM broadcast stations (76–107.9 MHz).

➔ Push [MODE] one or more times to select the desired receive mode.

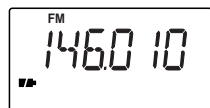

FM mode



AM mode



WFM mode

■ Display backlighting

The receiver has display backlighting with a 5 sec. timer for nighttime operation. The display backlighting can be turned ON continuously or turned OFF, if desired.

➔ Push any switch except [FUNC]; or, rotate [DIAL] to turn the backlighting ON.

- When auto backlighting is set, the backlighting will automatically turn OFF when switches and [DIAL] have not been operated for 5 sec.

◇ Setting the backlighting condition

- ① Push [V/M] for 2 sec. to enter set mode.
- ② Rotate [DIAL] until "LIGHT" appears.
 - "LIGHT" disappears after 1 sec. and the previously selected backlighting timer and "LI" appear.
- ③ While pushing [FUNC], rotate [DIAL] to select the desired backlighting condition.
- ④ Push [V/M] to exit set mode.

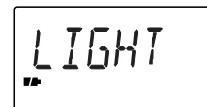

Backlighting set mode



Automatic backlighting



Continuously OFF

5

MEMORY CHANNELS

■ General

The receiver has 400 memory channels in 8 banks for storage of often-used frequencies.

◇ Memory channel contents

The following information can be programmed into memory channels:

- Operating frequency (p. 7)
- Receive mode (p. 11)
- Tuning step (p. 7)
- Duplex direction (DUP or –DUP) with an offset frequency (p. 24)
- Tone squelch ON/OFF (p. 22)
- Tone squelch frequency (p. 22)
- Scan skip setting (p. 18)

■ Programming during selection

- ① Select VFO mode with [V/M].
- ② Set the desired frequency:
 - Select the desired band with [BAND].
 - Set the frequency using [DIAL].
 - Set other data (e.g. offset frequency, duplex direction, tone squelch frequency, etc.), if required.
- ③ Push [FUNC] + [(V/M)MW] momentarily to indicate memory channels.
 - Do not hold [FUNC] + [(V/M)MW] for more than 0.5 sec., otherwise the previously selected memory channel will be overwritten.
- ④ Rotate [DIAL] to select the desired channel.
 - VFO (VF), as well as regular memory channels, can be programmed in this way.
 - Rotate [DIAL] while pushing [FUNC] to select a memory bank, programmed scan edge channel or VFO.
- ⑤ Push [FUNC] + [(V/M)MW] for 1 sec. to program.
 - Keep pushing for 2 sec. or more to automatically select the next memory channel, if desired.

[EXAMPLE]: Programming ch 40 of memory bank 5 during selection.

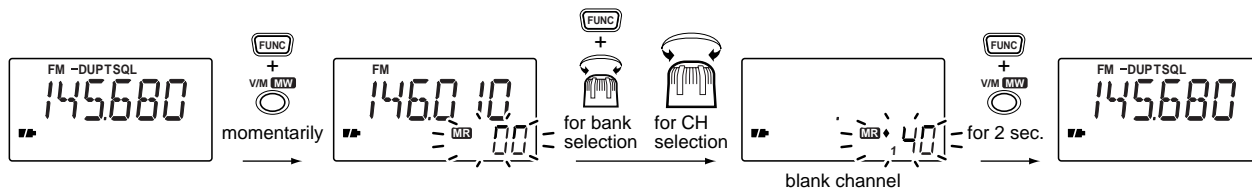

■ Programming after selection

- ① Select memory mode with [V/M].
- ② Set the memory channel to be programmed with [DIAL].
 - Rotate [DIAL] while pushing [FUNC] to select a memory bank or programmed scan edge channel.
 - Non-programmed channels cannot be selected.
- ③ Push [V/M] to select VFO mode.
- ④ Set the desired frequency:
 - ➔ Select the desired band with [BAND].
 - ➔ Set the frequency using [DIAL].
 - ➔ Set other data (e.g. offset frequency, duplex direction, tone squelch frequency, etc.), if required.
- ⑤ Push [FUNC] + [(V/M)MW] for 1 sec. to program the selected channel.
 - Keep pushing for 2 sec. or more to automatically select the next memory channel, if desired.

■ Transferring memory contents to another memory

- ① Select memory mode with [V/M].
- ② Select the memory channel to transfer with [DIAL].
 - Rotate [DIAL] while pushing [FUNC] to select a memory bank or programmed scan edge channel.
- ③ Push [FUNC] + [(V/M)MW] momentarily to indicate memory channels.
 - Do not hold [FUNC] + [(V/M)MW] for more than 0.5 sec., otherwise the memory channel contents will be transferred to VFO.
- ④ Rotate [DIAL] to select the channel to transfer to.
 - Rotate [DIAL] while pushing [FUNC] to select a memory bank or programmed scan edge channel.
 - VFO (VF), as well as regular memory channels, can be transferred in this way.
- ⑤ Push [FUNC] + [(V/M)MW] for 2 sec. to transfer.

[EXAMPLE]: Transferring memory channel 3 (memory bank 0) to 20 (memory bank 0).

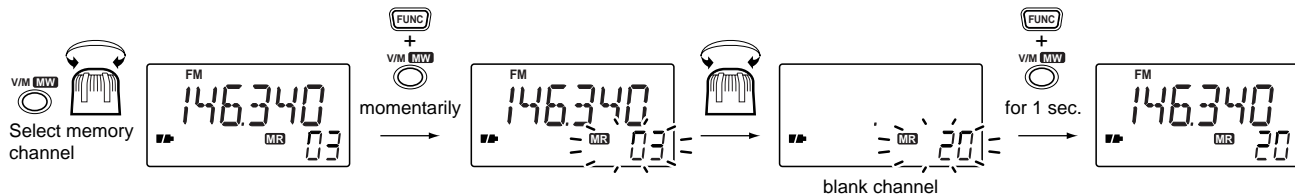

5 MEMORY CHANNELS

■ Memory bank selection

The receiver has 400 memory channels in 8 banks for storage of often-used frequencies.

- ① Select memory mode with [V/M].
- ② Rotate [DIAL] while pushing [FUNC] to select the desired memory banks.
 - “1” – “3” indicate memory banks 1 to 3; “♦” indicates memory bank 4; “♦ 1” – “♦ 3” indicate memory banks 5 to 7; no bank indicator indicates memory bank 0.
- ③ Rotate [DIAL] to select the desired memory channel.



■ Memory clear

Unwanted memory channels can be cleared (erased). Before clearing a memory channel make sure it is no longer needed as cleared memories cannot be recalled.

- ① Select memory mode with [V/M].
- ② Set the memory channel to be cleared with [DIAL].
 - Rotate [DIAL] while pushing [FUNC] to select a memory bank or programmed scan edge channel.
- ③ Select VFO mode with [V/M] and push [FUNC] + [(V/M)MW] momentarily to indicate the selected memory channel.
 - Do not hold [FUNC] + [(V/M)MW] for more than 0.5 sec., otherwise the selected memory channel will be overwritten.
- ④ Push [FUNC] + [(MODE)LOCK] for 2 sec. to clear the selected memory channel.
 - 3 beeps sound, then the frequency is cleared.
- ⑤ Push [V/M] to return to VFO mode.

[EXAMPLE]: Clearing memory channel 3 (memory bank 0).

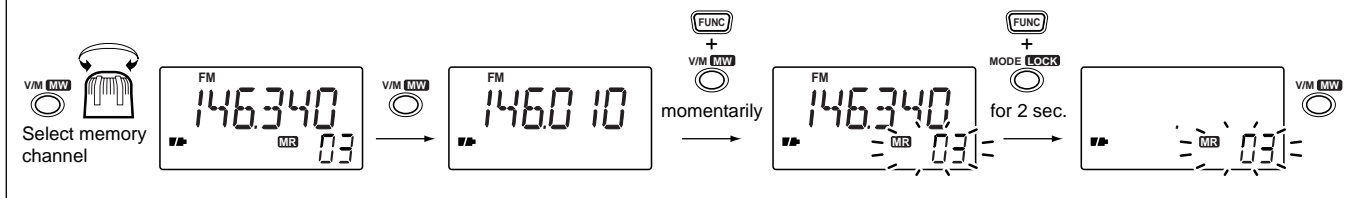

■ Scan types

Up to 25 programmed scan ranges, full scan, band scan and memory bank scan provide scanning versatility. Each scan can have skip channels programmed.

FULL SCAN (p. 16)

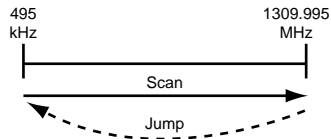

Repeatedly scans all frequencies over the entire receiver range.

U.S.A. version cannot receive some frequencies.

SELECTED BAND SCAN (p. 16)

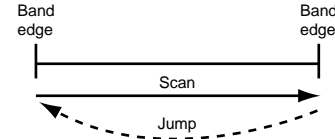

Repeatedly scans all frequencies over the entire selected band.

PROGRAMMED SCAN (p. 16)

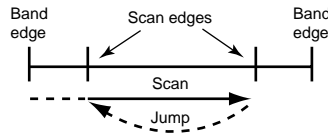

Repeatedly scans between two user-programmed frequencies. Used for checking for frequencies within a specified range such as repeater output frequencies, etc.

MEMORY (BANK) SCAN (p. 16)

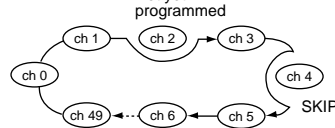

Repeatedly scans memory channels except skip channels within all programmed channels or within a memory bank (0–7).

FREQUENCY SKIP FUNCTION (p. 19)

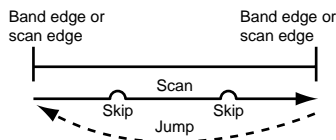

Skips unwanted frequencies that inconveniently stop scanning. This function can be turned ON and OFF in frequency skip function set mode. ([FUNC] + [(TS) SKIP])

MEMORY SKIP FUNCTION (p. 18)

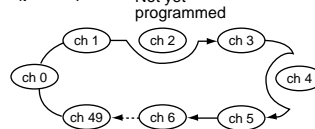

Skips unwanted memory channels that inconveniently stop scanning. Skip channels can be toggled ON and OFF by pushing [FUNC] + [(TS) SKIP] in memory mode.

6 SCAN OPERATION

■ Full/band/programmed scan

- ① Select VFO mode with [V/M].
- ② Make sure the squelch is set to the threshold point.
 - Select automatic squelch (AUTO) or a level (1–9) where the noise is just muted. (p. 10)
- ③ Select the desired scan range, if desired.
 - ↳ Select scan edges in scan edge set mode:
 - “ALL” for full scan, “BAND” for band scan or “PROG 0”–“PROG24” for programmed scan. (see the next page)
- ④ Push [FUNC] + [▲] or [▼] momentarily to start the scan.
 - Decimal point flashes while scanning.
 - “P SKIP” flashes when the frequency skip function is turned ON. (p. 19)
 - “0P”–“24P” flash to indicate which pair of scan edges is being scanned.
 - To change the scanning direction, rotate [DIAL].
 - If the pocket beep function is activated, the receiver automatically selects the tone squelch function when a scan starts.
- ⑤ To stop the scan, push [FUNC] + [▲] or [▼] again.

▨ If the same frequencies are programmed into a pair of scan edges, programmed scan does not start.

▨ For programmed scan, scan edges must be programmed in advance. Program scan edges in the same manner of programming a memory channel and select a scan edge. (p. 17)

■ Memory (bank) scan

- ① Select memory mode with [V/M].
- ② Make sure the squelch is set to the threshold point.
 - Select automatic squelch (AUTO) or a level (1–9) where the noise is just muted. (p. 10)
- ③ Turn the memory bank scan ON or OFF in the memory scan set mode, if desired.
 - See below for details.
- ④ Push [FUNC] + [▲] or [▼] momentarily to start the memory (bank) scan.
 - Decimal point flashes while scanning.
 - To change the scanning direction, rotate [DIAL].
 - If the pocket beep function is activated, the receiver automatically selects the tone squelch function when a scan starts.
- ⑤ To stop the scan, push [FUNC] + [▲] or [▼] again.

◇ Memory bank selection

- ① Select memory mode with [V/M].
- ② While pushing [FUNC], push [BAND] to enter memory scan set mode.
- ③ Rotate [DIAL] to select the memory bank scan ON or OFF.
 - “ALL” indicates all memory banks are scanned (memory bank scan OFF); “BANK” indicates memory bank scan is turned ON.
- ④ Push [BAND] to exit memory scan set mode.



Bank scan ON

■ Selecting scan edges

The scanning range can be set to all frequencies (full scan), a selected band or between two user-programmed frequencies (programmed scan).

/// The programmed scan edges can be programmed in the same manner as programming regular memory channels. Program the desired scan edge frequencies in a pair of programmed scan edge channels in advance. (pgs. 12, 13)

- ① Select VFO mode with [V/M].
- ② While pushing [FUNC], push [BAND] to enter band edge set mode.
- ③ Rotate [DIAL] to select the desired scan edge.
 - "ALL" for full scan, "BAND" for band scan or "PROG 0" – "PROG24" for programmed scan.
- ④ Push [BAND] to exit band edge set mode; or push [FUNC] + [▲] or [▼] momentarily to start the programmed scan using the selected edges.



Full scan



Band scan



Programmed scan 24
(Scan edge channels
24A and 24b)

6 SCAN OPERATION

■ Skip channel setting

Memory channels can be set to be skipped for memory skip scan. In addition, memory channels can be set to be skipped for both memory skip scan and frequency skip scan. These are useful to speedup the scan interval.

- ① Select memory mode with [V/M].
- ② Rotate [DIAL] to select a memory channel to be programmed as a skip channel.
- ③ While pushing [FUNC], push [(TS)SKIP] one or more times to select a condition.
 - No indication : channel will not be skipped.
 - “SKIP” appears : channel skipped during memory scan.
 - “P SKIP” appears : channel skipped during memory scan; frequency skipped during other scans.



Non-skip channel



Skip channel



Skip channel and
frequency skip channel

▨ The frequency skip function is effective when the frequency skip function (P SCAN) is turned ON. See the next page for details.

■ Scan resume condition

◇ Setting the scan pause time

The scan pauses when receiving signals according to the scan pause time. It can be set from 2–20 sec. or unlimited.

- ① Push [V/M] for 2 sec. to enter expanded set mode.
- ② Rotate [DIAL] until “PAUSE” appears.
 - Turn the expanded set mode ON for selection. (p. 25)
- ③ While pushing [FUNC], rotate [DIAL] to select the condition.
 - “2SEC”–“20SEC”: scan pauses for 2–20 sec. on a received signal.
 - “HOLD”: scan pauses on a received signal until it disappears.
- ④ Push [V/M] to exit set mode.

◇ Setting the scan resume time

The scan restarts after a signal disappears according to the resume time. It can be set from 0–5 sec. or unlimited.

- ① Push [V/M] for 2 sec. to enter expanded set mode.
- ② Rotate [DIAL] until “RESUME” appears.
 - Turn the expanded set mode ON for selection. (p. 25)
- ③ While pushing [FUNC], rotate [DIAL] to select condition.
 - “1SEC”–“5SEC”: scan restarts 1–5 sec. after the signal disappears.
 - “0SEC”: scan restarts immediately after the signal disappears.
 - “HOLD”: scan restarts by rotating [DIAL] only.
- ④ Push [V/M] to exit set mode.

■ Frequency skip function

◇ Programming a skip frequency

Unwanted frequencies can be skipped and programmed as skip channels when full scan, band scan or programmed scan is pausing.

- ① Start full scan, band scan or programmed scan. (p. 16)
- ② While receiving an unwanted signal and scan pauses, push [FUNC] + [(TS)SKIP] for 2 sec. to program the received frequency as a skip frequency.
 - The receiver emits 3 beeps and the scan resumes.
 - Non-programmed memory channels (blank channels) are used for skip frequency programming in reverse sequence.
 - To scan the skip frequency after programming, cancel the skip information (p. 18) or clear the memory channel (p. 14).



Indication while pausing



Indication while programming

◇ Frequency skip function ON/OFF

The frequency skip function can be turned OFF. In this case, the frequencies will not be skipped even if skip information is programmed and "P SKIP" does not appear.

- ① Select VFO mode with [V/M].
- ② Push [FUNC] + [(TS)SKIP] to toggle the frequency skip function ON or OFF.
 - "P SKIP" appears when the function is turned ON.



The frequency skip function is OFF.



The frequency skip function is ON.

Priority watch types

Priority watch checks for signals on a frequency every 5 sec. while operating on a VFO frequency or scanning. The receiver has 3 priority watch types to suit your needs.

In addition, you can be alerted with beeps and a flashing “🔔.”

The watch resumes according to the selected scan resume condition. See p. 18 for details.

/// If the pocket beep function is activated, the receiver automatically selects the tone squelch function when priority watch starts.

MEMORY CHANNEL WATCH

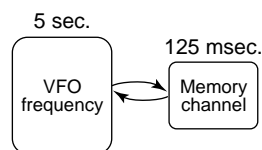

While operating on a VFO frequency, priority watch checks for a signal on the selected memory channel every 5 sec.

- A memory channel with skip information can be watched.

MEMORY SCAN WATCH

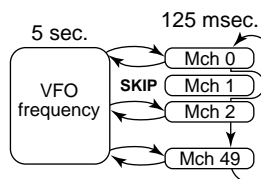

While operating on a VFO frequency, priority watch checks for signals on each memory channel in sequence.

- The memory skip function and/or memory bank scan is useful to speed up the scan.

VFO SCAN WATCH

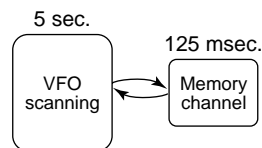

While scanning in VFO mode, priority watch checks for signals on the selected memory channel every 5 sec.

■ Priority watch operation

◇ Memory channel watch and memory scan watch

- ① Select VFO mode; then, set an operating frequency.
- ② Set the watching channel(s).

For memory channel watch:

Select the desired memory channel.

For memory scan watch:

Select memory mode; then, push [FUNC] + [▲] or [▼] momentarily to start memory scan.

- ③ Push [V/M] for 2 sec. to enter set mode.
- ④ Rotate [DIAL] until "PRIO" appears.
 - "PRIO" disappears after 1 sec. and "OFF" and "PR" appear.
- ⑤ While pushing [FUNC], rotate [DIAL] to select priority watch ON or priority watch ON with alert.
- ⑥ Push [V/M] to exit set mode and start the watch.
 - The receiver checks the memory channel frequency every 5 sec.
 - The watch resumes according to the selected scan resume condition. (p. 18)
- ⑦ Push [V/M] while the display shows the VFO frequency to stop the watch.



While pausing on the memory channel, "PRIO" flashes.

◇ VFO scan watch

- ① Select the desired memory channel to be watched.
- ② Push [V/M] to select VFO mode.
- ③ Push [FUNC] + [▲] or [▼] momentarily to start full scan, band scan or programmed scan. (p. 16)
- ④ Push [V/M] for 2 sec. to enter set mode.
- ⑤ Rotate [DIAL] until "PRIO" appears.
 - "PRIO" disappears after 1 sec. and "OFF" and "PR" appear.
- ⑥ While pushing [FUNC], rotate [DIAL] to select priority watch ON or priority watch ON with alert.
- ⑦ Push [V/M] to exit set mode and start the watch.
 - The receiver checks the memory channel frequency every 5 sec.
 - The watch resumes according to the selected scan resume condition. (p. 18)
- ⑧ Push [V/M] while the display shows the VFO frequency to stop the watch.



Priority watch set mode



Priority watch is ON.

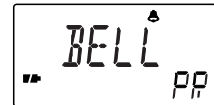

Priority watch with alert is ON.

8

SUBAUDIBLE TONE OPERATION

■ Tone squelch operation

◇ Operation

The tone squelch opens only when receiving a signal containing a matching subaudible tone. You can silently wait for calls from group members using the same tone in an amateur band.

- ① Set the operating frequency.
- ② Set the desired subaudible tone in expanded set mode.
 - See right for programming.
- ③ Push [V/M] for 2 sec. to enter expanded set mode.
- ④ Rotate [DIAL] until "TSQL" appears.

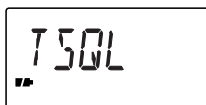

Tone function set mode

- Turn the expanded set mode ON for selection. (p. 25)
 - "TSQL" disappears after 1 sec. and "tO" appears.
- ⑤ While pushing [FUNC], rotate [DIAL] to select "TSQL."
 - ⑥ Push [V/M] to exit set mode and start the tone squelch.
 - ⑦ When the received signal includes a matching tone, squelch opens and the signal can be heard.
 - When the received signal's tone does not match, tone squelch does not open, however, the S-indicator shows signal strength.
 - To open the squelch manually, push and hold [SQL].
 - ⑧ To cancel the tone squelch, repeat steps ③–⑥ as described above and select "OFF" in step ⑤.

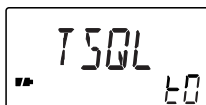

Tone squelch is ON.

◇ Setting subaudible tones for tone squelch operation

- ① Select VFO mode or desired memory channel to be programmed.
- ② Push [V/M] for 2 sec. to enter expanded set mode.
- ③ Rotate [DIAL] until "TONE" appears.
 - Turn the expanded set mode ON for selection. (p. 25)
 - "TONE" disappears after 1 sec. and "Ct" appears.
- ④ While pushing [FUNC], rotate [DIAL] to select a subaudible tone.
 - Each operating band and each memory channel have independent settings.
- ⑤ Push [V/M] to exit set mode.

• Available subaudible tone frequencies (unit: Hz)

67.0	82.5	100.0	123.0	151.4	171.3	189.9	210.7	250.3
69.3	85.4	103.5	127.3	156.7	173.8	192.8	218.1	254.1
71.9	88.5	107.2	131.8	159.8	177.3	196.6	225.7	
74.4	91.5	110.9	136.5	162.2	179.9	199.5	229.1	
77.0	94.8	114.8	141.3	165.5	183.5	203.5	233.6	
79.7	97.4	118.8	146.2	167.9	186.2	206.5	241.8	

◇ CONVENIENT

Store subaudible tone frequencies and tone squelch ON/OFF settings in memories for easy recall.

■ Pocket beep operation

This function uses subaudible tones for calling and can be used as a “common pager” to inform you that someone has called using the same tone in an amateur band while you were away from the receiver.

◇ Waiting for a call from a specific station

- ① Set the operating frequency.
- ② Set the desired tone squelch tone in expanded set mode.
 - See the previous page for programming information.
- ③ Push [V/M] for 2 sec. to enter expanded set mode.
- ④ Rotate [DIAL] until “TSQL” appears.
 - Turn the expanded set mode ON for selection. (p. 25)
 - “TSQL” disappears after 1 sec. and “O” appears.
- ⑤ While pushing [FUNC], rotate [DIAL] to select “P BEEP.”
- ⑥ Push [V/M] to exit set mode and start the pocket beep.
 - “TSQL 📞” appears in the function display.
- ⑦ When a signal with the correct tone is received, the receiver emits beep tones for 30 sec. and flashes “📞.”
- ⑧ Push [V/M] to stop the beeps and flashing.
 - Tone squelch is automatically selected.

▨ The receiver has 50 tone frequencies and consequently their spacing is narrow compared with units having 38 tones. Therefore, some tone frequencies may receive interference from adjacent tone frequencies.

■ Tone scan

The receiver can detect the subaudible tone frequency in a received signal. By monitoring a signal that is being transmitted on a frequency, you can check the tone frequency required to access the repeater or to open the tone squelch.

- ① Set the desired frequency or memory channel to be checked for a tone frequency.
- ② Push [FUNC] + [▲] or [▼] for 2 sec. to start the tone scan.
 - To change the scanning direction, rotate [DIAL].
- ③ When the tone frequency is decoded, the set mode contents are programmed with the tone frequency.
 - The tone scan pauses when a tone frequency is detected.
 - The decoded tone frequency is used for the tone squelch frequency.
 - “Ct” appears during tone scan.
- ④ Push [FUNC] + [▲] or [▼] to stop the scan.

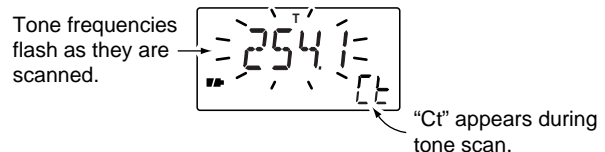

9

DUPLEX OPERATION

Duplex communication uses 2 different frequencies for transmitting and receiving. Generally, duplex is used in communication through a repeater, some utility communications, etc.

During duplex operation, the transmit station frequency is shifted from the receive station frequency by the offset frequency. Repeater information (offset frequency and shift direction) can be programmed into memory channels. (p. 12)

▨ This function is not available in the broadcast band (0.495–1.620 MHz) except for U.S.A. and Canada versions.

- ① Set the receive station frequency (repeater output frequency).
- ② Set the shift direction and offset of the transmit station frequency as described below.
- ③ Push and hold [SQL] to monitor the transmit station frequency (repeater input frequency) directly.

◇ Duplex shift direction

- ① Push [V/M] for 2 sec. to enter expanded set mode.
- ② Rotate [DIAL] until "DUP" appears.
 - Turn the expanded set mode ON for selection. (p. 25)
 - "DUP" disappears after 1 sec. and "dP" appears.
- ③ While pushing [FUNC], rotate [DIAL] to select "-DUP" or "+DUP"

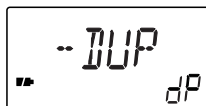

Minus shift

- "-DUP" or "+DUP" indicates the transmit station frequency for minus shift or plus shift, respectively.

- ④ Push [V/M] to exit set mode.

◇ Offset frequency

During duplex operation, the transmit station frequency is shifted from the receive station frequency by an amount determined by the offset frequency.

- ① Select VFO mode or desired memory channel to be programmed.
- ② Push [V/M] for 2 sec. to enter expanded set mode.
- ③ Rotate [DIAL] until "OFFSET" appears.
 - Turn the expanded set mode ON for selection. (p. 25)
 - "OFFSET" disappears after 1 sec. and "OW" appears.
- ④ While pushing [FUNC], rotate [DIAL] to set the desired offset.
 - The offset frequency changes according to the selected tuning step.
- ⑤ Push [V/M] to exit set mode.

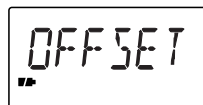

Offset frequency set mode



0.6 MHz (600 kHz) offset

■ Set mode

Set mode is used for programming infrequently changed values or conditions of functions.

In addition, this receiver has an expanded set mode which is used for programming additional infrequently changed values or conditions of functions. When turning OFF the expanded set mode, only a quarter of the set mode items are displayed for simpler operation.

◇ Expanded set mode ON/OFF

- ① Push [V/M] for 2 sec. to enter set mode.
- ② Rotate [DIAL] clockwise until "EXPAND" appears.
 - "EXPAND" disappears after 1 sec. and "EX" appears.
- ③ While pushing [FUNC], rotate [DIAL] to turn the expanded set mode ON or OFF.
- ④ Push [V/M] to exit set mode or rotate [DIAL] to select a set mode item.



Expanded set mode setting



Expanded set mode ON

◇ Set mode items

ⓔ STEP	Tuning step (p. 7)	BEEP	Confirmation beep (p. 26)
ⓔ D SEL	Dial select step (p. 26)	LIGHT	Backlighting (p. 11)
ⓔ TSQL	Tone squelch (p. 22)	ⓔ AP OFF	Auto power OFF (p. 27)
ⓔ TONE	Tone squelch tone (p. 22)	ⓔ P SAVE	Power save (p. 26)
ⓔ DUP	Duplex direction (p. 24)	ⓔ MONI	Monitor switch action (p. 27)
ⓔ OFFSET	Offset frequency (p. 24)	ⓔ SPEED	Dial speed (p. 28)
ⓔ RESUME	Scan resume time (p. 18)	ⓔ LOCK	Lock function effect (p. 28)
ⓔ PAUSE	Scan pause time (p. 18)	ⓔ CH	Channel indication mode (p. 29)
ⓔ PRIO	Priority watch (p. 21)	EXPAND	Expanded set mode (p. 25)

ⓔ: Appears when expanded set mode is ON.

ⓑ: Does not appear within the broadcast band (0.495–1.620 MHz) except for U.S.A. and Canada versions.

10 OTHER FUNCTIONS

■ Dial select step

This receiver has a 1 MHz tuning step for quick frequency setting. This dial select step can be set to 100 kHz, 1 MHz or 10 MHz steps, as desired.

This function is not available to the broadcast band (0.495–1.620 MHz) except for U.S.A. and Canada versions.

◇ Setting dial select step

- ① Select VFO mode with [V/M].
- ② Push [V/M] for 2 sec. to enter set mode.
- ③ Rotate [DIAL] until "D SEL" appears.
 - "D SEL" disappears after 1 sec. and "dS" appears.
- ④ While pushing [FUNC], rotate [DIAL] to select the desired dial select step.
 - 100 kHz, 1 MHz and 10 MHz steps can be selected.
- ⑤ Push [V/M] to exit set mode.



100 kHz step

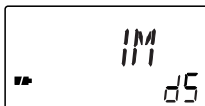

1 MHz step



10 MHz step

■ Beep tones

The confirmation beep tones, which sound each time a switch is pushed, can be turned ON or OFF, as desired.

- ① Push [V/M] for 2 sec. to enter set mode.
- ② Rotate [DIAL] until "BEEP" appears.
 - "BEEP" disappears after 1 sec. and "bE" appears.
- ③ While pushing [FUNC], rotate [DIAL] to turn the confirmation beep ON or OFF.
- ④ Push [V/M] to exit set mode.

■ Power saver

The power saver function reduces the current drain to conserve battery power.

- ① Push [V/M] for 2 sec. to enter expanded set mode.
- ② Rotate [DIAL] until "P SAVE" appears.
 - Turn the expanded set mode ON for selection. (p. 25)
 - "P SAVE" disappears after 1 sec. and "PS" appears.
- ③ While pushing [FUNC], rotate [DIAL] to turn the power saver ON (AUTO) or OFF.
- ④ Push [V/M] to exit set mode.

■ Auto power-off function

The receiver can be set to automatically turn OFF after a specified period in which no switch is pushed.

120 min., 90 min., 60 min., 30 min. and OFF can be specified. The specified period is retained even when the receiver is turned OFF by the auto power-off function. To cancel the function, select "OFF" in step ③ below.

- ① Push [V/M] for 2 sec. to enter expanded set mode.
- ② Rotate [DIAL] until "AP OFF" appears.
 - Turn the expanded set mode ON for selection. (p. 25)
 - "AP OFF" disappears after 1 sec. and "AO" appears.
- ③ While pushing [FUNC], rotate [DIAL] to select the desired time or to turn the function OFF.
- ④ Push [V/M] to exit set mode.

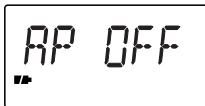

Auto power off set mode

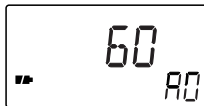

60 min. auto power-off



Auto power-off is turned OFF.

■ Monitor switch action

The monitor switch can be set as a 'sticky' switch. When set to the sticky condition, each push of [SQL] toggles the monitor function on and off.

- ① Push [V/M] for 2 sec. to enter expanded set mode.
- ② Rotate [DIAL] until "MONI" appears.
 - Turn the expanded set mode ON for selection. (p. 25)
 - "MONI" disappears after 1 sec. and "mO" appears.
- ③ While pushing [FUNC], rotate [DIAL] to set the monitor switch to sticky (HOLD) or normal (PUSH).
- ④ Push [V/M] to exit set mode.



Monitor switch function set mode



'Sticky' action

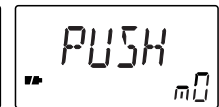

'Normal' action

10 OTHER FUNCTIONS

■ Dial speed acceleration

The dial speed acceleration automatically speeds up the tuning dial speed when rotating the [DIAL] rapidly.

- ① Push [V/M] for 2 sec. to enter expanded set mode.
- ② Rotate [DIAL] until "SPEED" appears.
 - Turn the expanded set mode ON for selection. (p. 25)
 - "SPEED" disappears after 1 sec. and "SP" appears.
- ③ While pushing [FUNC], rotate [DIAL] to set the dial speed acceleration ON or OFF.
- ④ Push [V/M] to exit set mode.



Dial speed acceleration set mode



Dial speed acceleration ON



Dial speed acceleration OFF

■ Lock function effect

The lock function prevents accidental frequency changes and accidental function access.

While the lock function is ON, [POWER], [VOL] and [SQL] can still be accessed. Accessible switches can be set to 1 of 4 groups in expanded set mode.

- ① Push [V/M] for 2 sec. to enter expanded set mode.
- ② Rotate [DIAL] until "LOCK" appears.
 - Turn the expanded set mode ON for selection. (p. 25)
 - "LOCK" disappears after 1 sec. and "Lk" appears.
- ③ While pushing [FUNC], rotate [DIAL] to select the accessible switches.
 - "NORMAL" : [POWER], [VOL] and [SQL] are accessible.
 - "NO SQL" : [POWER] and [SQL] are accessible.
 - "NO VOL" : [POWER] and [VOL] are accessible.
 - "ALL" : [POWER] is accessible.
- ④ Push [V/M] to exit set mode.



Lock function effect set mode



[POWER], [VOL] and [SQL] are accessible.



[POWER] is accessible.

■ Channel indication mode

Channel indication mode is used to simplify operation. In this mode only pre-programmed memory channel numbers are displayed and functions are limited ([POWER], [SQL], [VOL], [LOCK], scanning and the tuning dial are functional).

- ① Select memory mode with [V/M].
- ② Push [V/M] for 2 sec. to enter expanded set mode.
- ③ Rotate [DIAL] until "CH" appears.
 - Turn the expanded set mode ON for selection. (p. 25)
- ④ While pushing [FUNC], rotate [DIAL] to turn the channel indication ON or OFF.
- ⑤ Push [V/M] to exit set mode.

- To return to normal indication, turn this function OFF in step ④ above.
- Frequencies must be programmed into memory channels in advance.

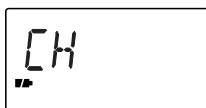

Channel indication mode set mode



Channel indication mode ON

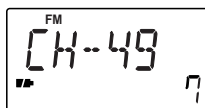

Channel indication mode example (Memory ch 49 of memory bank 7)

■ Cloning function

The IC-R2 has receiver-to-receiver data cloning capability. This function is useful when you want to copy all of the programmed contents from one IC-R2 to another. An optional OPC-474 CLONING CABLE is required.

▨ The optional CS-R2 CLONING SOFTWARE and the optional OPC-478 CLONING CABLE are available to clone and edit contents using a PC.

- ① While pushing [TS], [V/M] and [▲], push [POWER] for 1 sec. to enter cloning mode.
 - "CLONE" appears.
- ② Connect an optional OPC-474 between both [SP] jacks.
- ③ Push [SQL] on the "master" receiver (receiver-to-receiver cloning only).
 - "CL OUT" appears and the signal indicator shows that cloning is taking place.

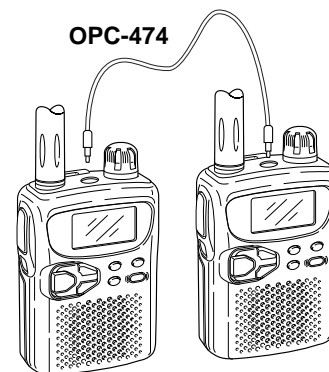

10 OTHER FUNCTIONS

■ Partial reset

If you want to initialize the operating conditions (VFO frequency, VFO settings, set mode contents) without clearing the memory contents, a partial resetting function is available for the receiver.

↳ While pushing [FUNC] and [V/M], turn power ON to partially reset the receiver.

■ All reset

Reset the CPU before operating the receiver for the first time, or when the internal CPU malfunctions.

↳ While pushing [FUNC], [BAND] and [V/M], turn power ON to reset the CPU.

- “CLEAR” appears when resetting the CPU.

 **CAUTION:** Resetting the CPU returns all programmed contents to their default settings.

TROUBLESHOOTING 11

If your receiver seems to be malfunctioning, please check the following points before sending it to a service center.

PROBLEM	POSSIBLE CAUSE	SOLUTION	REF.
No power comes ON.	<ul style="list-style-type: none">•The batteries are exhausted.•The battery polarity is reversed.	<ul style="list-style-type: none">•Replace the batteries.•Check the battery polarity.	p. 1 p. 1
No sound comes from the speaker.	<ul style="list-style-type: none">•Volume level is too low.•Different tone is selected with tone squelch.	<ul style="list-style-type: none">•Push [VOL ▲] to obtain a suitable level.•Check the tone using tone scan.	p. 10 p. 23
Frequency cannot be set.	<ul style="list-style-type: none">•The lock function is activated.•Channel indication mode is selected.	<ul style="list-style-type: none">•Push [FUNC] + [(MODE)LOCK] to cancel the function.•Turn the channel indication mode OFF in set mode.	p. 8 p. 29
No beeps sound.	<ul style="list-style-type: none">•Beep tones are turned OFF.	<ul style="list-style-type: none">•Turn beep tones ON in set mode.	p. 26
Receive audio is distorted.	<ul style="list-style-type: none">•The operating mode is not selected correctly.	<ul style="list-style-type: none">•Select a suitable operating mode in set mode.	p. 11
Desired set mode item cannot be selected.	<ul style="list-style-type: none">•The desired set mode item is in expanded set mode.•Some set mode items cannot be selected in the broadcast band.	<ul style="list-style-type: none">•Turn the expanded set mode ON.•Choose a band other than the broadcast band.	p. 25 p. 25

12 OPERATION FLOW CHART

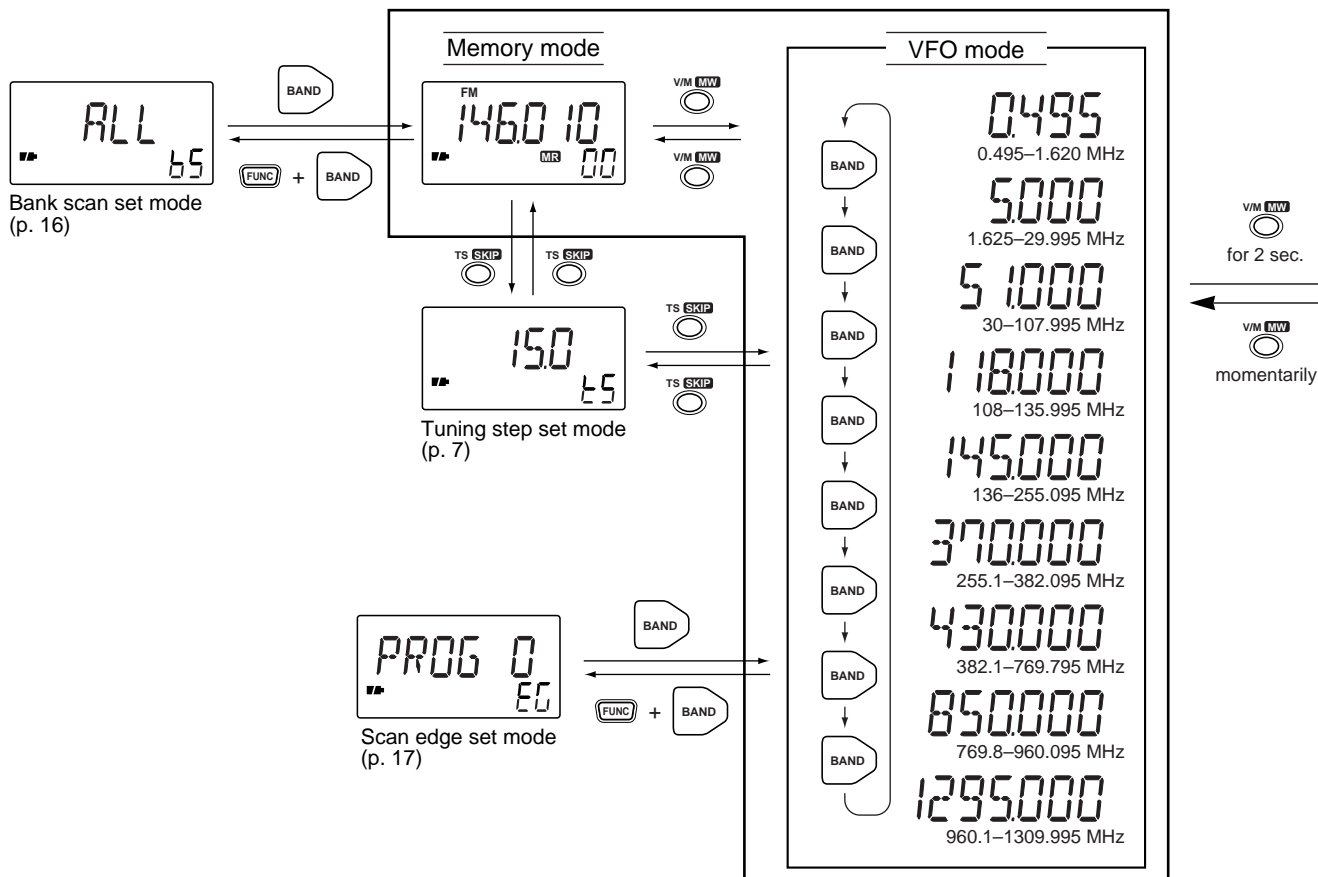

OPERATION FLOW CHART 12

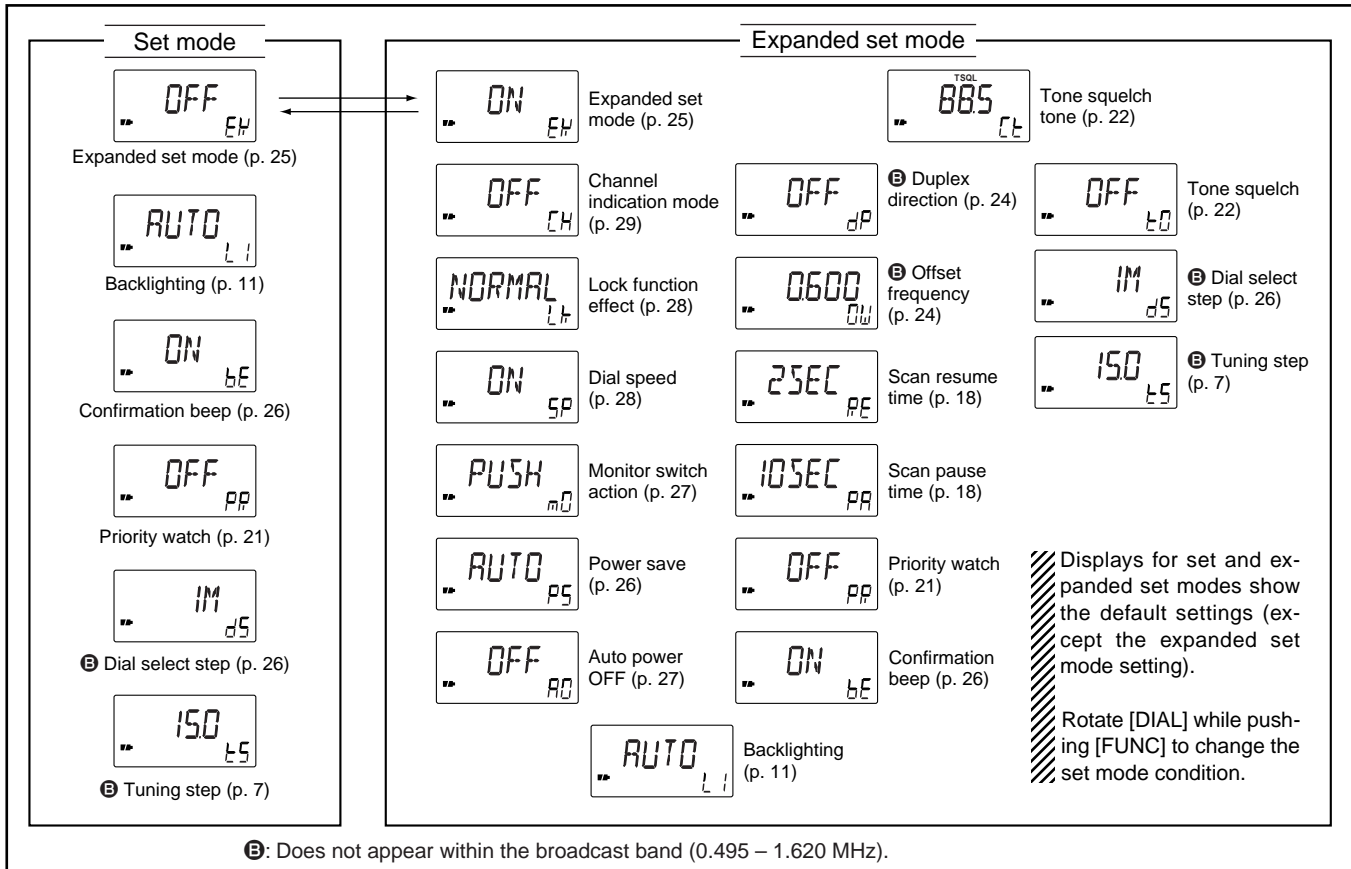

13 SPECIFICATIONS AND OPTIONS

◇ General

- Frequency coverage : (unit: MHz)
U.S.A. version 0.495–823.995, 849–868.995,
894–1309.995
Non-U.S.A. versions 0.495–1309.995
- Mode : FM, AM, WFM
- No. of memory channels : 450
(400 regular, 50 scan edges)
- Usable temp. range : –10°C to +60°C;
+14°F to +140°F
- Tuning steps : 5, 6.25, 9,* 10, 12.5, 15, 20,
25, 30, 50 and 100 kHz
* Fixed tuning step while 0.495–1.620 MHz is selected except
for U.S.A. and Canada versions.
- Frequency stability : ±6 ppm (–10°C to +60°C)
- Power supply requirement : 2 AA(R6) Ni-Cd or
(negative ground) alkaline cells
- Current drain (at 3.0 V DC) :
Rated audio 170 mA typ.
Standby 100 mA typ.
Power saved 41 mA typ.
- Antenna connector : SMA (50 Ω)
- Dimensions : 58(W)×86(H)×27(D) mm;
(projections not included) 2⁹/₃₂(W)×3³/₈(H)×1¹/₁₆(D) in
- Weight : 170 g; 6 oz
(w/antenna and battery)

◇ Receiver

- Receive system : Triple-conversion
superheterodyne
- Intermediate frequencies : 1st 266.7 MHz
2nd 19.65 MHz
3rd 450 kHz
- Sensitivity (except spurious points; typical):
FM 1.625–5.000 MHz 0.4 μV
(at 12 dB SINAD) 5.005–29.995 MHz 0.25 μV
30–117.995 MHz 0.2 μV
118–174.995 MHz 0.18 μV
175–329.995 MHz 0.22 μV
330–429.995 MHz 0.25 μV
430–450 MHz 0.22 μV
450.005–469.995 MHz 0.25 μV
470–999.995 MHz 0.28 μV
1000–1309.995 MHz 0.45 μV
WFM 76–108.0 MHz 0.71 μV
(at 12 dB SINAD) 175–221.995 MHz 0.71 μV
470–770.0 MHz 1.0 μV
AM (at 10 dB S/N) 0.495–5.0 MHz 1.3 μV
5.005–30.0 MHz 0.79 μV
118–136.0 MHz 0.63 μV
222–246.995 MHz 0.63 μV
247–329.995 MHz 0.71 μV

- Selectivity :
 FM, AM More than 15 kHz/–6 dB
 Less than 30 kHz/–60 dB
 WFM More than 150 kHz/–6 dB
- Audio output power : 100 mW typ. at 10% distortion
 (at 3.0 V DC) with an 8 Ω load
- SP connector : 3-conductor 3.5 (d) mm
 (1/8")/8 Ω

◇ **Options**

BC-127A/D BATTERY CHARGER

Regularly charges 2 or 4 AA (R6) Ni-Cd batteries. 2 Ni-Cd batteries are supplied with the BC-127A/D.

LC-146 CARRYING CASE

Helps protect the receiver from scratches, etc.

SP-13 EARPHONE

Provides clear receive audio in noisy environments.

HP-4 HEADPHONE

Provides increased readability of signals in noisy environments and listening privacy.

AD-92SMA ANTENNA CONNECTOR ADAPTER

Allows you to connect an antenna with a BNC connector. (SMA to BNC adapter)

CS-R2 CLONING SOFTWARE + OPC-478 CLONING CABLE

Allows you to transfer data from memories, etc. and quickly and easily edit and store data via a PC.

OPC-474 CLONING CABLE

Used for handheld-to-handheld cloning.

All stated specifications are subject to change without notice or obligation.

Count on us!

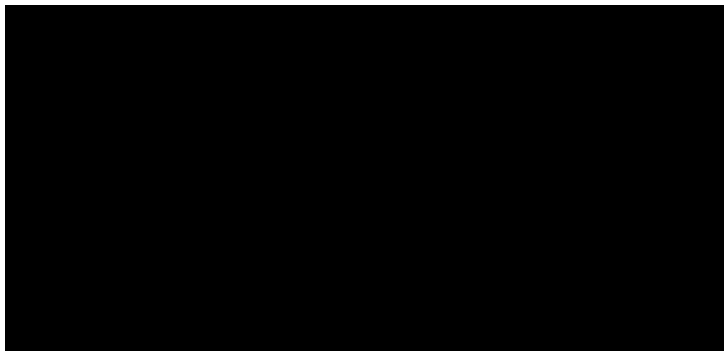

A-5520H-1EX
Printed in Japan
© 1998 Icom Inc.

Icom Inc.
6-9-16 Kamihigashi, Hirano-ku, Osaka 547-0002 Japan