

IC-255A

144MHz FM TRANSCEIVER

INSTRUCTION MANUAL



TABLE OF CONTENTS

I. SPECIFICATIONS	2
II. DESCRIPTION	3
III. INSTALLATION	4
IV. CONTROL FUNCTIONS.....	7
V. OPERATION	12
VI. INSIDE VIEW	21
VII. TROUBLE SHOOTING.....	23
IX. VOLTAGE CHARTS.....	25
X. BLOCK DIAGRAM.....	28
XI. P.C. BOARD LAYOUT.....	SEPARATE
XII. SCHEMATIC DIAGRAM.....	SEPARATE

SECTION I SPECIFICATIONS

GENERAL

Numbers of semi-conductors	:	Transistors	49
		FET	4
		IC	29
		Diode	80
Frequency coverage	:	143.800 ~ 148.195MHz	
Frequency resolution	:	15KHz steps 5KHz steps with TS switch depressed	
Frequency Control	:	Microcomputer based Digital PLL synthesizer. Independent Transmit-Receive Frequency Capability	
Memory channels	:	5 channels, any inband frequency programmable	
Usable conditions	:	Temperature: $-10^{\circ}\text{C} \sim 60^{\circ}\text{C}$ ($14^{\circ}\text{F} \sim 140^{\circ}\text{F}$) Operationable time: continuous	
Frequency stability	:	Within $\pm 1.5\text{KHz}$	
Antenna impedance	:	50 ohms unbalanced	
Power supply requirement	:	13.8V DC $\pm 15\%$ (negative ground) 5.5A Max.	
Current drain	:	Transmitting	
		HIGH (25W)	Approx. 5.5A
		LOW (1W)	Approx. 1.5A
		Receiving	
		At max audio output	Approx. 0.7A
		Squelched	Approx. 0.5A
Dimensions	:	185mm (W) x 64mm (H) x 223mm (D)	
Weight	:	Approx. 2.5kg	

TRANSMITTER

Output power	:	25W (HIGH), 1W (LOW)	
Emission mode	:	16F ₃	
Modulation system	:	Variable reactance frequency modulation	
Max. frequency deviation	:	$\pm 5\text{KHz}$	
Spurious emission	:	More than 60dB below carrier	
Microphone	:	1.3K ohm dynamic microphone with built-in preamplifier and push-to-talk switch	
Operating mode	:	Simplex, Duplex ($\pm 600\text{KHz}$ from receive frequency and any inband frequency separation programmable)	

RECEIVER

Receiving system	:	Double-conversion superheterodyne	
Modulation acceptance	:	16F ₃	
Intermediate frequency	:	1st:	10.75MHz
		2nd:	455KHz
Sensitivity	:	More than 30dB S+N+D/N+D at $1\mu\text{V}$ Less than $0.6\mu\text{V}$ for 20dB Noise quieting	
Squelch sensitivity	:	Less than $0.4\mu\text{V}$	
Spurious response rejection ratio	:	More than 60dB	
Selectivity	:	More than $\pm 7.5\text{KHz}$ at -6dB point Less than $\pm 15\text{KHz}$ at -60dB point	
Audio output power	:	More than 2.0W	
Audio output impedance	:	8 ohms	

SECTION II DESCRIPTION

144MHz FM TRANSCEIVER INCORPORATING A MICROCOMPUTER

CPU control with ICOM's original programs provides various operating capabilities. Frequency control, band-edge detection, and the display are accomplished by the microcomputer. The 5-channel memory is controlled electrically by the use of a 256-bit RAM area. The circuits for these IC-255A functions are equivalent in capability to conventional circuits having a large number of C-MOS MSI's.

TWO VFO'S BUILT-IN

No extra equipment needed for split-frequency operation. Easy writing and reading of the five memory channels. Smooth and easy tuning with 15KHz and 5KHz steps.

MULTI-PURPOSE SCANNING

Memory Scan allows you to monitor five different memory channels. Program Scan provides scanning between two programmed frequencies. Adjustable scanning speed. Auto-stop stops scanning when a signal is received, or a frequency is not being used.

SUPERIOR RECEIVING CHARACTERISTICS

The use of newly developed low-noise and large dynamic range junction FET's (for the RF amplifier and the first mixer) and of helical cavity filters (for the antenna and RF circuits) provides excellent sensitivity and intermodulation distortion characteristics. A pair of high quality monolithic crystal filters and ceramic filters facilitates very stable receiving and excellent durability.

HIGHLY STABLE TRANSMITTING CHARACTERISTICS

Both the directly amplified VCO output without the use of multipliers or mixers and the use of a power module in the PA unit produce very clean transmitting signals without spurious radiation. RF power is selectable 25W (HIGH) and 1W (LOW). 25W HIGH output power will increase your QSO range.



SECTION III INSTALLATION

UNPACKING

Carefully remove your transceiver from the packing carton and examine it for signs of shipping damage. Should any be apparent, notify the delivering carrier or dealer immediately, stating the full extent of the damage. It is recommended you keep the shipping cartons. In the event storage, moving, or reshipment becomes necessary, they come in handy. Accessory hardware, cables, etc., are packed with the transceiver. Make sure you have not overlooked anything.

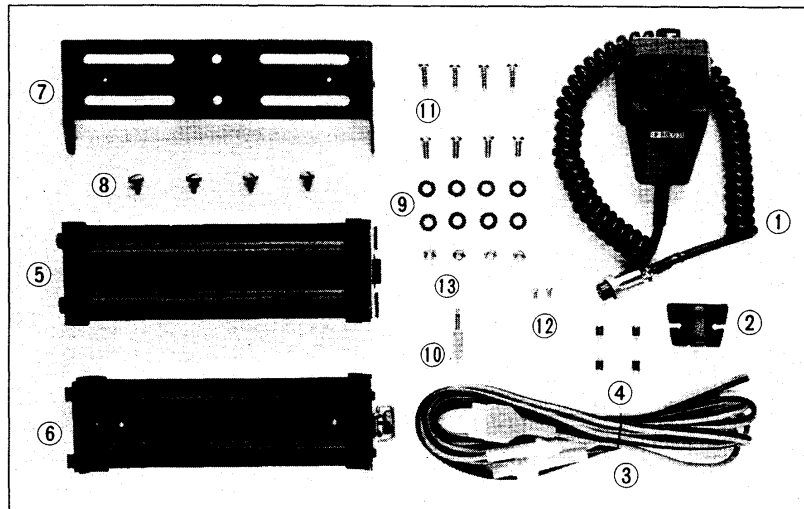

1. Microphone (dynamic type)	1	8. Gimp screws	4
2. Microphone hook	1	9. Flat washers	12
3. Power cord	1	10. Plug for speaker	1
4. Spare fuses (10A)	2	11. Mounting screws	8
5. Installing holder A	1	12. Screws for additional bracket.	2
6. Installing holder B	1	13. Mounting screw's nuts	4
7. Installing angle joint.	1		

LOCATION

Where you place the transceiver in your automobile is not critical and should be governed by convenience and accessibility. Since the unit is so compact, many mobile possibilities present themselves. In general, the mobile mounting bracket will provide you with some guide as to placement. Any place where it can be mounted with metal screws, bolts, or pop-rivets will work. For fixed station use, a power supply should be designed to produce 6 amps for the transceiver.

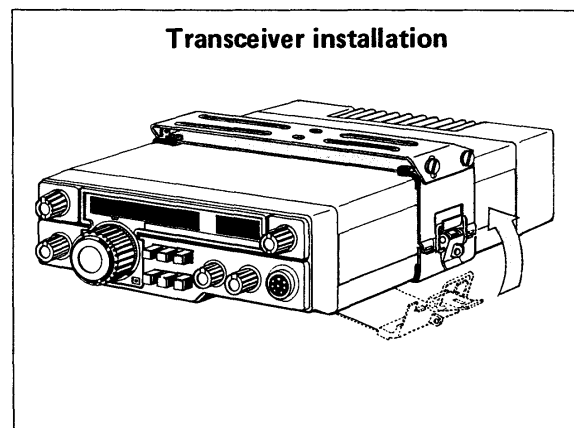
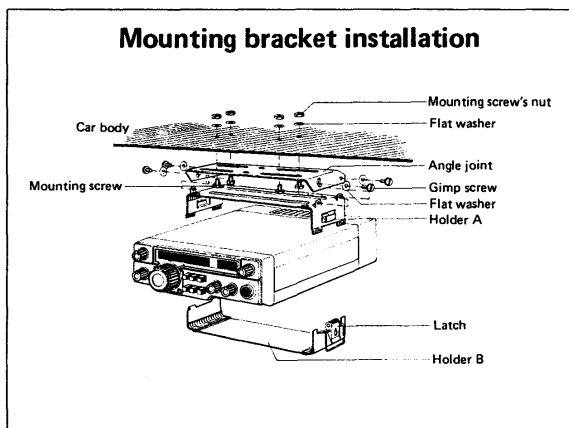

Angle adjustment

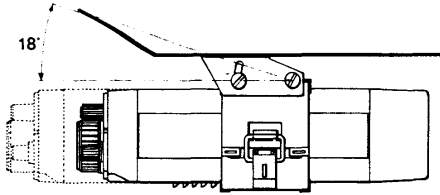

Optional installation

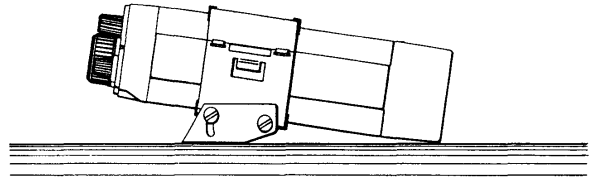

POWER REQUIREMENTS

The transceiver is supplied ready to operate from any regulated 13.8V DC, 6 ampere negative ground source. An automobile 12 volt, negative ground, system is usually more than adequate. Some note must be taken, however, of the condition of the vehicle's electrical system. Items such as low battery, worn generator/alternator, poor voltage regulator, etc., will impair operation of your transceiver as well as the vehicle. High noise generation or low voltage delivery can be traced to these deficiencies. If an AC power supply is used with your transceiver, make certain it is adequately regulated for both voltage and current. Low voltage while under load will not produce satisfactory results from your transceiver. Receiver gain and transmitter output will be greatly impaired. Caution against catastrophic failure of the power supply should be observed.

CAUTION: Excessive Voltage (above 15VDC) will cause damage to your transceiver. Be sure to check source voltage before plugging in the power cord.

Included with your transceiver is a DC power cable with plug attached. The Red Wire is positive (+), the Black, negative (-). If your mobile installation permits, it is best to connect these directly to the battery terminals. This arrangement eliminates random noise and transient spikes sometimes found springing from automotive accessory wiring. If such an arrangement is not possible, then any convenient B+ lead in the interior of the vehicle and the negative frame can be utilized. Remember, the unit operates on a negative ground system only; it cannot be used in a positive ground automobile. After making your connections, simply insert the plug into your transceiver.

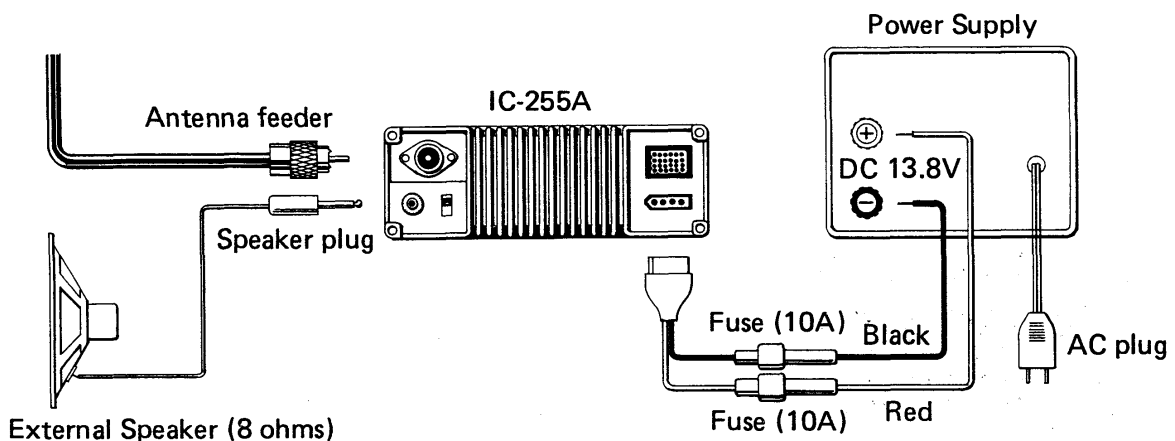

ANTENNA

The most important single item that will influence the performance of any communication system is the antenna. For that reason, a good, high-quality, gain antenna of 50 ohms impedance is recommended, fixed or mobile. In VHF as well as the low bands, every watt of ERP makes some difference. Therefore, 25 watts average output plus 3dB of gain antenna equals 50 watts ERP, presuming low VSWR of course. The few more dollars invested in a gain type antenna is well worth it. When adjusting your antenna, whether mobile or fixed, by all means follow the manufacturer's instructions. There are some pitfalls to be aware of. For example, do not attempt to adjust an antenna for lowest VSWR when using a diode VSWR meter not engineered for VHF applications. Such readings will invariably have an error of 40% or more. Instead, use an in line watt meter similar to the Drake WV-4, Bird Model 43 or Sierra Model 164B with VHF cartridge. Further, when adjusting a mobile antenna, do so with the motor running preferably above normal idling speed. This will insure proper voltage level to the transceiver.

The RF coaxial connector on the rear chassis mates with a standard PL-259 connector. Some models may have metric threads. In any event, the RF connector will mate with almost any PL-259 connector if care is taken to seat them properly.

MICROPHONE

A high quality dynamic microphone with built-in preamplifier is supplied with your transceiver. Merely plug it into the proper receptacle on the front panel. Should you wish to use a different microphone, make certain it has a proper preamplifier. Particular care should be exercised in wiring also, as the internal electric switching system is dependent upon it. See the schematic for the proper hook up.

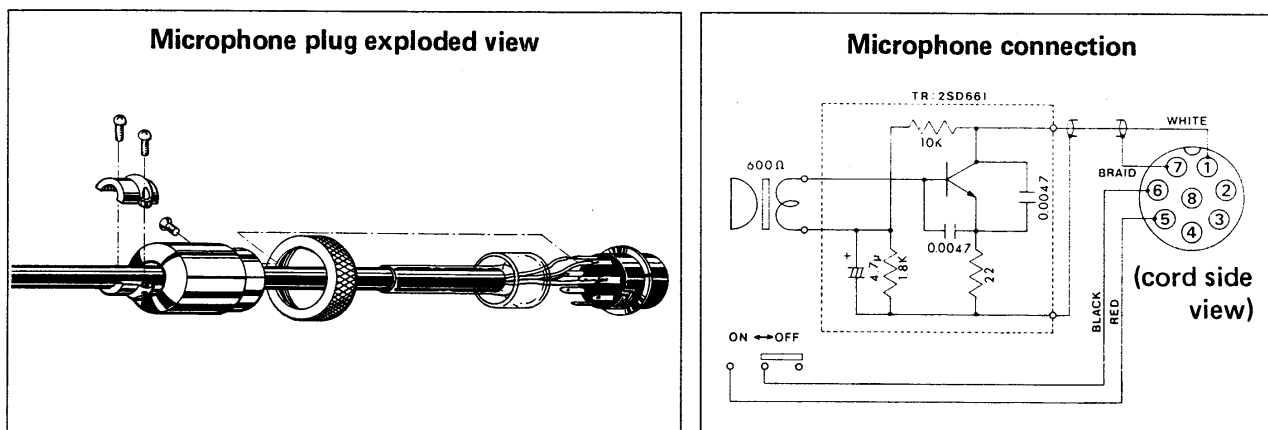

EXTERNAL SPEAKER

An external speaker jack and plug is supplied with your unit in the event another speaker is desirable. The external speaker impedance should be 8 ohms, and when used, will disable the internal speaker. An 8 ohm headset can be utilized as well.

SECTION IV CONTROL FUNCTIONS

FRONT PANEL

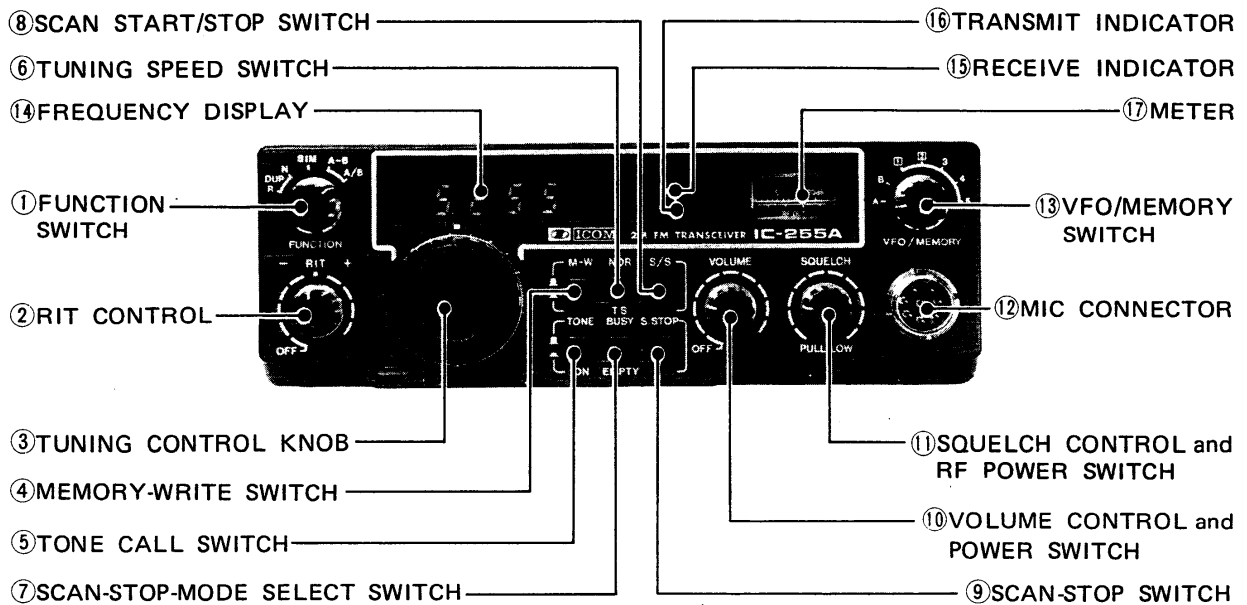

1. FUNCTION SWITCH

With this switch you can select the relationship of the two VFO's, and the duplex modes. The switch performs the following operations according to its position.

DUP-R: The transmitting frequency is set 600KHz above the receiving frequency in Duplex operation. This operation may be utilized with the VFO/Memory Switch in any position.

DUP-N: The transmitting frequency is set 600KHz below the receiving frequency which is set at any position of the VFO/Memory Switch, and the tuning control.

SIM: Selects "A" VFO for both transmit and receive when the VFO/Memory Switch is set in the "A" position, and selects "B" VFO for both transmit and receive when the VFO/Memory Switch is set in the "B" position.

However, the other VFO will follow the selected VFO at the same frequency difference they were set at.

A-B: The VFO/Memory Switch set at the "A" position, selects "A" VFO for receive and "B" VFO for transmit.

"B" VFO will follow "A" VFO at the same frequency difference they were set at.

When the VFO/Memory Switch is set at the "B" position, "B" VFO is selected for receive and "A" VFO for transmit.

"A" VFO will follow "B" VFO at the same frequency difference they were set at.

A/B: The VFO/Memory Switch set at the "A" position, selects "A" VFO for both transmit and receive.
When the VFO/Memory Switch is set at the "B" position, "B" VFO is selected for both transmit and receive.
In the either cases, "A" VFO and "B" VFO do not have a relationship, and both VFO's can be used independently.

2. RIT CONTROL

Shifts the receive frequency $\pm 3\text{KHz}$ either side of the transmit frequency. Rotating the control to the (+) side raises the receiver frequency, and rotating to the (-) side lowers the receiver frequency. The frequency shift by turning the RIT Control is not indicated on the frequency display.

If the OFF position is desired, turn the RIT Control completely counterclockwise. (It will "click" OFF). Then the transmit and the receive frequencies are the same.

3. TUNING CONTROL KNOB

Rotating the TUNING CONTROL KNOB clockwise increases the frequency, while rotating it counterclockwise decreases the frequency. The frequency is changed in 15KHz steps which correspond to the click-stops. The smaller vernier marks on the knob each indicate two click-stops and the larger marks represent ten stops.

When tuning up past 148.185MHz, (148.195MHz when TS Switch is pushed.) the frequency will automatically revert to 143.800MHz. Likewise, when tuning down past 143.805MHz, the frequency will automatically revert to 148.190MHz (148.195MHz).

4. MEMORY-WRITE SWITCH

After setting the tuning control to the desired frequency, with the VFO/Memory Switch in the "A" position, set the VFO/Memory switch to the channel to be programmed (1~5). One push of the M-Write Switch erases the previous programmed frequency and programs the new frequency. (Depressing the M-Write Switch when the VFO/Memory Switch is set at "A" neither erases nor programs a frequency.)

5. TONE CALL SWITCH

When the optional Tone Call unit is installed, depressing the Tone Call Switch for the required period for a repeater, puts the set in the transmit mode and the tone burst generator actuates and you can access the repeater.

When the Tone Call unit is not installed, this switch can be used for a Transmit/Receive switch.

6. TUNING SPEED SWITCH

Pushing the tuning speed switch in the rotating the tuning knob will result in changing the frequency in 5KHz steps.

7. SCAN STOP MODE SELECT SWITCH

Selects the scan stop mode where either the scan stops on a received signal or the scan stops on an empty channel.

8. SCAN START/STOP SWITCH

Starts the memory scan or the programmed scan, and stops any of the scan functions. When depressing it again to restart the scan, it will start from the initial memory channel or frequency.

When the scan has been stopped by auto-stop or by depressing ⑨ SCAN STOP SWITCH, by depressing the SCAN START/STOP SWITCH to restart the scan, it will start from the stopped memory channel or frequency.

9. SCAN STOP SWITCH

Manually stops any of the scan functions.

10. VOLUME CONTROL and POWER SWITCH

When the control is turned completely counterclockwise, the power is OFF. By turning the control clockwise beyond the "click", the unit is turned ON and the audio level increases by further rotating it clockwise.

11. SQUELCH CONTROL and RF POWER SWITCH

Turning this control clockwise sets the squelch threshold higher. To turn OFF the squelch function, turn this control completely counterclockwise.

By pulling the Squelch control knob, the RF output power is reduced to 1 watt. By depressing the knob to the normal position, the RF output power returns to 25 watts.

12. MIC CONNECTOR

Connect the supplied microphone to this jack. If you wish to use a different microphone, refer to the drawing on page 6.

13. VFO/MEMORY SWITCH

Selects operation with the tuning control ("A" and "B" positions) or operation with the memory channels (1~5). See "PROGRAMMING THE MEMORY CHANNELS" on page 15 for more details.

In addition, when the VFO is switched from one VFO to the other VFO, the frequency indicated on the frequency display just prior to switching goes into a memory inside the CPU. Thus even if "B" VFO is being used, switching to "A" again will enable you to operate at the initial "A" frequency. Switching back from "A" to "B" results in the same operation.

14. FREQUENCY DISPLAY

The four large 7 segment LED's represent 1MHz, 100KHz, 10KHz and 1KHz digits of the operating frequency. If you turn the RIT control ON to change the receive frequency and rotate the RIT control knob, the frequency display will not change.

15. RECEIVE INDICATOR

Illuminates when the squelch is opened in the receive mode.

16. TRANSMIT INDICATOR

Illuminates in the transmit mode.

17. METER

The numbers on the S-meter represent S1 through S9 and 20 and 60dB over S9. The RF output level meter functions only as a relative output meter and does not indicate the wattage. These functions are switched automatically when T/R switching is made.

REAR PANEL

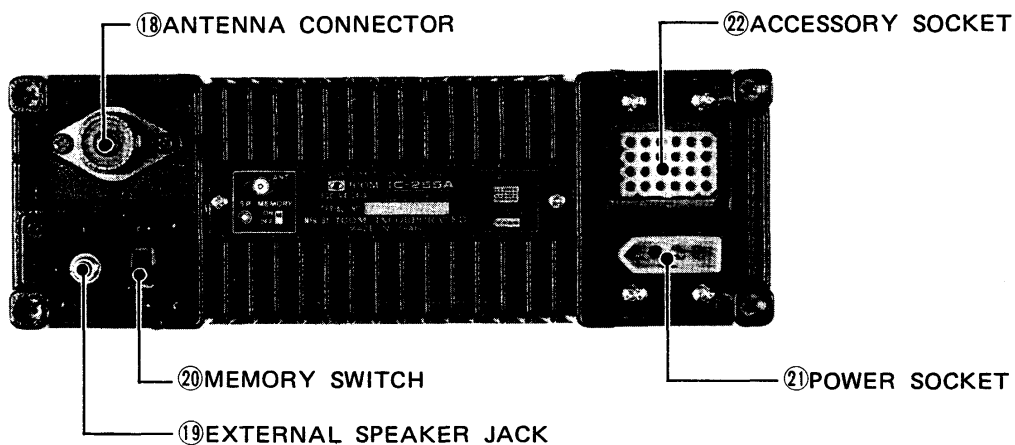

18. ANTENNA CONNECTOR

This is used to connect the antenna to the set. Its impedance is 50 ohms and connects with a PL-259 connector.

19. EXTERNAL SPEAKER JACK

When an external speaker is used, connect it to this jack. Use a speaker with an impedance of 8 ohms. When the external speaker is connected the built-in speaker does not function.

20. MEMORY SWITCH

When this switch is in the ON (up) position, the power to the CPU of the IC-255A is supplied continuously, even when the POWER Switch on the front panel is turned OFF, to retain all the programmed frequencies in the Memory Channels, the operating frequencies of the two VFO's, etc. When this switch is set at the OFF (down) position, all the power, including that to the CPU, is turned OFF by turning OFF the POWER Switch, so that all the programmed frequencies in the Memory Channels, the operating frequencies of the two VFO's etc., are erased.

21. POWER SOCKET

Connect the supplied power cord to this socket.

22. ACCESSORY SOCKET

The table on next page shown terminal connections of this connector.

NOTE: IC-RM2/3 does not function with the IC-255A.

ACC SOCKET CONNECTIONS

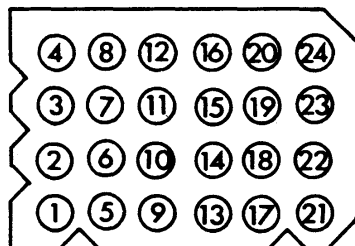

Outside view

PIN No.	FUNCTION
1.	Output from squelch control stage. (+7V when squelch is ON)
2.	13.8 Volts DC in conjunction with the power switch operation. (0.3A Max.)
3.	Connected to Push-to-talk, T/R change-over switch. When grounded, the set operates in the transmit mode.
4.	Output from the receiver detector stage. Fixed output regardless of AF output of AF gain.
5.	Input to Transmitter MIC amplifier stage.
6.	8 Volts DC available when transmitting. (Relay can not be directly actuated. 5mA Max.)
7.	NC (no connection).
8.	Ground.
9.	NC (no connection).
10.	Output of the applied voltage to the meter.
11. ~ 15.	NC (no connection).
16.	Control signal (DBC) input terminal for external control.
17.	NC (no connection).
18.	NC (no connection).
19.	Control signal (DV) output terminal for external control.
20.	Control signal (RT) input terminal for external control.
21.	Data signal (DB1) input/output terminal for external control.
22.	Data signal (DB2) input/output terminal for external control.
23.	Data signal (DB4) input/output terminal for external control.
24.	Data signal (DB8) input/output terminal for external control.

SECTION V OPERATION

HOW TO TUNE

The following instructions are for tuning. Please read carefully and understand fully before turning ON your unit. Proper tuning is necessary for optimum operation.

PRESET FREQUENCIES

When the POWER switch is turned ON, the frequency display will show 5.010 for 146.010 MHz.

Turn the VFO/Memory Switch from "A" to "B" positions to see if the same frequency can be read on the display. By continuing to turn the VFO/Memory Switch to the "1", "2", "3", "4", and "5" positions 5.010 is also shown on the display. The frequencies of the VFO's and the Memory Channels are preset so that they start from the frequencies shown above whenever the IC-255A is turned ON with the MEMORY Switch in the OFF position or whenever the power to the CPU is cut for even a short time. Turn the VFO/Memory Switch to the "A" position again.

TUNING CONTROL

Rotating the Tuning Knob clockwise increases the frequency; turning it counterclockwise decreases the frequency in 15KHz steps (5KHz steps when the TS Switch is pushed IN.).

The click stops of the knob change in 15KHz steps (5KHz when the TS Switch is pushed IN.) each. The smaller vernier marks on the knob represent two click stops and the larger marks represent ten click stops. One complete rotation of the tuning knob results in a 750KHz (250KHz when the TS Switch is pushed IN) frequency increase or decreases.

When you reach 148.185MHz (148.195MHz when the TS Switch is push IN) turning the Tuning Control Knob clockwise will bring the operating frequency to 143.800MHz, the lowest edge, and you can continue increasing the frequency from there by continuing to rotate the Knob clockwise. The VFO endless system functions in the same way when decreasing the frequency from 143.805 MHz, and will prevent you from inadvertently operating out of the amateur radio band.

TUNING SPEED (TS) SWITCH

By pushing the TS Switch IN, the frequency is increased or decreased in 5KHz steps.

VFO/MEMORY SWITCH and FUNCTION SWITCH

The CPU in the IC-255A contains two "VFO's" for both receiving and transmitting. The VFO's are labeled "A" VFO and "B" VFO and are selectable with the VFO/MEMORY Switch. This dual VFO system gives the IC-255A many very convenient features. Please read this section very carefully and perform the operation several times until you are comfortable with the system. Try the example!

1. When FUNCTION Switch is in the "DUP-R" position, the receive frequency is selected by placing the VFO/MEMORY Switch in any position, "A", "B" or Memory 1~5. The transmit frequency is set 600KHz above the receive frequency.
2. When the FUNCTION Switch is in the "DUP-N" position, the transmit frequency is set 600KHz below the receive frequency.
3. When the FUNCTION Switch is in the "SIM" position, "A" VFO is for both transmitting and

receiving and is selected by placing the VFO/MEMORY Switch in the "A" position. The transmit and receive frequency will be controlled by "A" VFO, displayed on the frequency display and stored in "A" memory. However "B" VFO will follow "A" VFO at the same frequency difference they were set at.

By placing the VFO/MEMORY Switch in the "B" position, the transmit and receive frequency will be controlled by "B" VFO, and "A" VFO will follow "B" VFO at the same frequency difference they were set at.

If the VFO/MEMORY switch is in a position between Memory 1 and 5 the transmit and receive frequency will be controlled by each memorized frequency.

4. With the FUNCTION Switch in the "A-B" position, and the VFO/MEMORY Switch is in "A" position, the receive frequency is controlled by "A" VFO and the transmit frequency is controlled by "B" VFO. Both frequencies are stored in their respective memories, and displayed during their respective operation times ("A" frequency during receive, and "B" frequency during transmit).

With the VFO/MEMORY Switch in the "B" position, the receive frequency is controlled by "B" VFO and the transmit frequency is controlled by "A" VFO, the reverse of the above. Again, both frequencies are stored in their respective memories, and displayed during their respective operation times (this time "B" frequency during receive and "A" frequency during transmit).

If the VFO/MEMORY Switch is in a position between Memory 1 and 5, the transmit and receive frequency will be controlled by each memorized frequency. (The set works in the Simplex mode.)

5. When the FUNCTION Switch is in the A/B position, and the VFO/MEMORY Switch is in the "A" position, the transmit and receive frequency will be controlled by "A" VFO, displayed on the frequency display, and stored in "A" memory.

When the VFO/MEMORY Switch is in "B" position, the transmit and receive frequency will be controlled by "B" VFO, displayed on the frequency display, and stored in "B" memory.

Either VFO frequency can be set independently. This is very convenient to preset frequency difference for split frequency operation.

When the VFO/MEMORY Switch is in the Memory positions, the transmit and receive frequency will be controlled by each memorized frequency.

- When the IC-255A is first turned ON, the frequency displayed on the readout is the frequency 146.010MHz.

FOR EXAMPLE:

When the set is turned ON, 6.010 will be displayed on the readout. This will occur with the VFO/MEMORY Switch and the FUNCTION Switch in any position. Rotating the tuning knob clockwise will increase the frequency, and rotating the tuning knob counterclockwise will decrease the frequency in 15KHz steps. (5KHz when the TS Switch is pushed IN.)

- Switching from one VFO to the other VFO does not clear the first VFO. The frequency is retained in the VFO's memory.

FOR EXAMPLE:

With the FUNCTION Switch in the "A/B" position, if 146.520MHz is set with "A" VFO, and the VFO/MEMORY Switch is set to "B" VFO, the frequency readout will show "B" VFO's frequency, but 146.520MHz is still stored in "A" VFO's memory. Returning the VFO switch to "A" VFO position, and 6.520 will be displayed on the readout. Accordingly, if the switch is placed in the "B" VFO position, the frequency that was set with the "B" VFO will appear. This allows you to set a certain frequency with one VFO, work up and down the band with the other VFO, and periodically check the set frequency simply by switching between "A" and "B" VFO. It also allows you to search for a clear frequency with one VFO, while keeping your operating frequency on the other VFO. When you have found a clear frequency, switch back to your operating frequency, inform the station you are in contact with of the new frequency, and switch back. It's that simple!

NOTE: If the FUNCTION Switch is in "A-B" or "SIM" position, one VFO will follow the other VFO, thus this function is available only with the VFO/MEMORY Switch in the A/B position.

- "DUP-N" or "DUP-R" position will allow you to access a repeater that has a 600KHz input/output frequency separation.

FOR EXAMPLE:

Set "A" VFO to 146.940MHz. Then set the FUNCTION Switch to the DUP-N position. 6.940 will shown on the readout during receive and 6.340 during transmit. You are now receiving on 146.940MHz and transmitting on 146.340MHz, so you can access an 146.34/146.94 repeater.

If you change the receiving ("A" VFO) frequency from 146.940MHz to 146.880MHz, the transmitting frequency will change from 146.340MHz to 146.280MHz, so now you can access an 146.28/146.88 repeater.

Setting the FUNCTION Switch to "DUP-R" position changes the transmitting frequency to 600KHz above the receiving frequency.

If you set "A" VFO to 147.120MHz, the transmitting frequency will be 147.720MHz.

These functions will be available also in "B" and Memory 1~5 positions of the VFO/MEMORY Switch.

- "A-B" position will allow you to operate repeaters or split transmit/receive frequencies that have a frequency difference other than ± 600 KHz.

FOR EXAMPLE:

Set "A" VFO to 145.025MHz and "B" VFO to 144.725MHz. Then set the FUNCTION Switch to the "A-B" position. 5.025 will shown on the readout during receive ("A" VFO) and 4.725 during transmit ("B" VFO). You are now receiving on 145.025MHz and transmitting on 144.725 MHz, so you can access a 300KHz separation 144.725/145.025 repeater.

If you change the receiving ("A" VFO) frequency, the transmitting ("B" VFO) frequency will follow the receiving frequency at the same frequency difference. So, first, set "A" VFO and "B" VFO at the frequencies for repeater input/output frequency separation. This makes repeater operation simple.

FOR EXAMPLE:

If you change the receiving frequency from 145.025MHz to 145.125MHz, the transmitting frequency will change from 144.725MHz to 144.825MHz, so now you can access an 144.825/145.125 repeater.

Setting the VFO/MEMORY Switch to "B" reverses the above.

When you want to change to the SIMPLEX mode from DUPLEX operation, set the FUNCTION Switch to the SIM position.

The transmit and receive frequency will now be controlled by "A" VFO, but "B" VFO will follow "A" VFO at the same frequency difference they were set at, so you can return to DUPLEX operation easily.

RIT (RECEIVER INCREMENTAL TUNING)

By using the RIT circuit, you can shift the receive frequency ± 3 KHz either side of the transmit frequency without moving the transmit frequency itself. Therefore, when you get a call slightly off frequency, or when the other station's frequency has shifted, you can tune in the receiving frequency without disturbing the transmitting frequency.

When the RIT knob is in the center (12 o'clock) position, the transmitting and receiving frequencies are the same. Rotating the control to the (+) side raises the receiving frequency, and rotating to the (-) side lowers the frequency. To turn OFF the RIT control, turn the knob completely counterclockwise to the OFF position. (It will "click" OFF.)

When the RIT circuit is OFF, the transmit and receive frequencies are the same.

Other things to remember are: The frequency shifted by turning the RIT control is not indicated on the frequency display. When the transmitting and receiving frequencies differ by more than 3KHz, use "A" and "B" VFOs as outlined previously.

MEMORY CHANNEL OPERATION

MEMORY-WRITE (PROGRAMMING THE MEMORY CHANNELS)

Only "A" VFO can be used for memory-writing.

1. Set the Tuning Control to the desired frequency, using "A" VFO. For example, set it for **6.940** on the display.
2. Set the VFO/MEMORY Switch to the channel to be programmed (1, 2, or 3 ~ 5). For example, set it at Memory Channel 1. If no frequency has been programmed since turning the power of the unit ON, **6.010** will be shown on the display and the unit will receive on 146.010MHz.
3. One push of the Memory-Write Switch erases the previous programmed frequency 146.010MHz

and programs the new frequency 146.940MHz into Memory Channel 1.

4. Program any desired frequencies in Memory Channels ② through 5 in the same manner. Memory Channels ① and ② are used also for Programmed Scan. For Programmed Scan operation, refer to SCANNING OPERATION.

MEMORY READING

Set the VFO/MEMORY Switch to the desired Memory Channel ①, ②, or 3 ~ 5. At whichever frequency the memory was set, that previously programmed frequency is recalled. When the VFO/MEMORY Switch is set back to "A" or "B" VFO, the previous operating frequency of that VFO will again be shown on the display.

The programmed frequencies in the five Memory Channels are maintained as long as the MEMORY power of the IC-255A is not turned OFF or new frequencies reprogrammed. When the MEMORY Switch on the rear panel is set to ON (up), all the programmed frequencies on the Memory Channels and the operating frequencies of both "A" and "B" VFO's are retained even when the POWER Switch is turned OFF.

SCANNING OPERATION

The IC-255A provides various scanning operations. Read the following instructions carefully to fully enjoy the IC-255A's many capabilities.

MEMORY SCAN

This is to scan the five Memory Channels continuously.

1. Program five desired frequencies in Memory Channels ①, ②, 3, 4, and 5.
2. Set the VFO/MEMORY Switch to any memory position.
3. Depress the Scan Start/Stop (S/S) Switch, and the display frequency starts scanning the programmed frequency in the memory channels from where the VFO/MEMORY Switch is set, and proceeds in order thereafter.

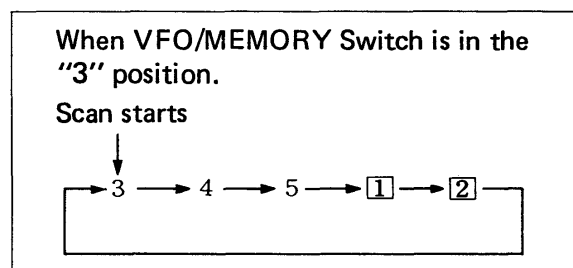
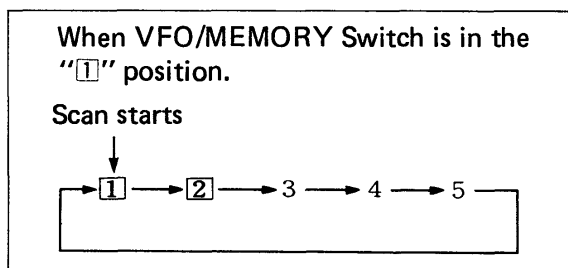

4. If the squelch is engaged, and the Scan-Stop-Mode Select Switch is in the BUSY (out) position, the scan stops when the squelch is opened and a signal is received.
5. If the Scan-Stop-Mode Select Switch is in the EMPTY (locked in) position, the scan stops when the squelch is closed and the memory channel is empty.

6. To stop the scanning without the auto-stop actions, depress the Scan Start/Stop Switch or Scan-Stop switch.
7. To restart the scanning, depress the Scan Start/Stop Switch again. When the scanning has been stopped by depressing the Scan Start/Stop Switch, the scanning will start from where the VFO/MEMORY Switch is set.

When the scanning has been stopped by depressing the Scan-Stop Switch or with the auto-stop action, the scanning will start from the stopped Memory Channel.

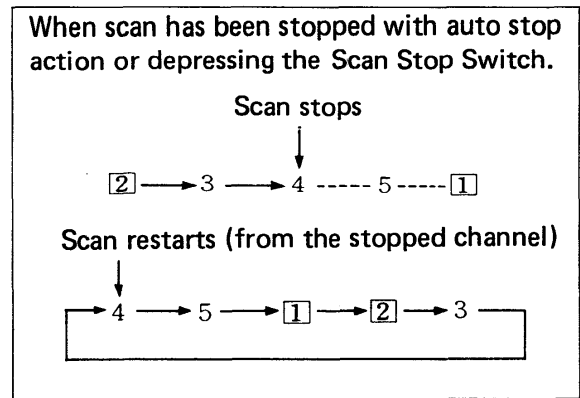
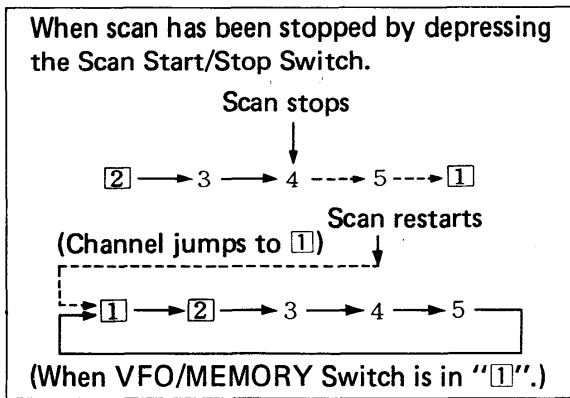

PROGRAMMED SCAN

This is to scan between two desired frequencies, which are programmed in Memory Channels 1 and 2.

1. Program the frequencies of the high and low edge of the desired scanning range in Memory Channels 1 and 2. Regardless of which channel the higher frequency is programmed in, the scan starts from the low edge of the range.

For example, program 146.700MHz in Memory Channel 1 (low edge) and 147.000MHz in Memory Channel 2 (high edge).

2. Set the VFO/MEMORY Switch to the "A" or "B" position.

Depressing the Scan Start/Stop Switch, the frequency jumps to the low edge frequency and starts the scan from the low edge to the high edge.

The scanning frequency increments depend on the Tuning Speed switch (5KHz or 15KHz).

3. When the scanning frequency reaches the high edge (147.000MHz), it automatically returns to the low edge (146.700MHz) and continues scanning up to provide endless scanning operation.

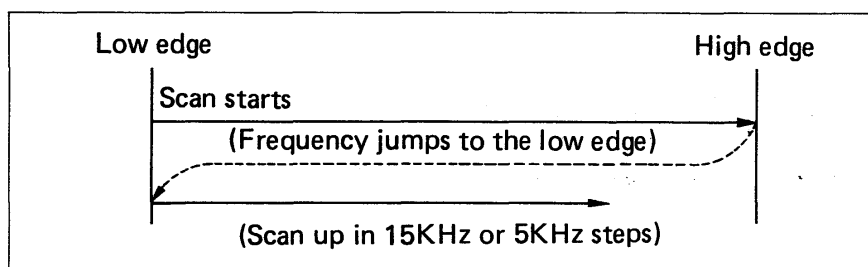

- If the squelch is engaged, and the Scan-Stop-Mode Select Switch is in the BUSY (out) position, the scan stops when the squelch is opened and a signal is received.

If the squelch is not engaged when the Scan Start/Stop Switch has been depressed, the scan does not stop at any signals.

- If the squelch is opened by a signal and the Scan-Stop-Mode Select Switch is in the EMPTY (locked in) position, the scan stops when the squelch is closed and a channel is empty.
- To stop the scanning without the auto-stop actions, depress the Scan Start/Stop Switch or Scan-Stop Switch.
- To restart the scanning, depress the Scan Start/Stop Switch again. When the scanning has been stopped with depressing the Scan Start/Stop Switch, the scanning will start from the low edge (146.700MHz).

When the scanning has been stopped with depressing the Scan-Stop Switch or with the auto-stop action, the scanning will restart from the frequency the scan stopped at.

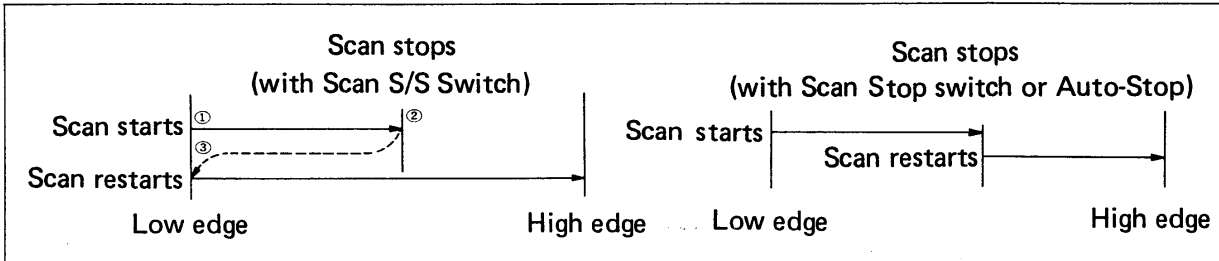

- If this frequency is changed with turning the Tuning Control knob while the scan is stopped, the scanning will restart from the VFO frequency.

In this case, if the VFO frequency is higher than the high edge frequency, the frequency jumps to the low edge frequency (146.700MHz) and restarts from the low edge.

If the changed frequency is below the low edge frequency and the Scan Start/Stop Switch is pushed, scanning will begin at the VFO frequency, scan up to the high edge but will return to the preprogrammed low edge frequency.

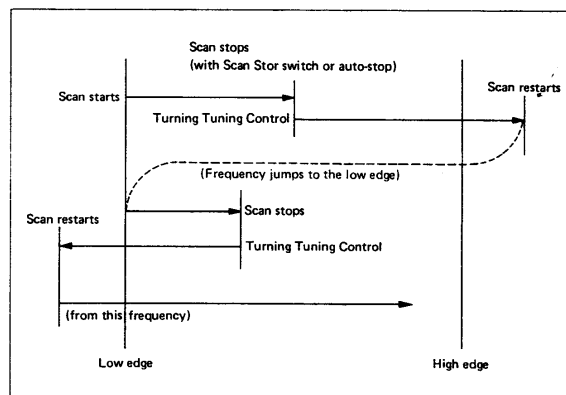
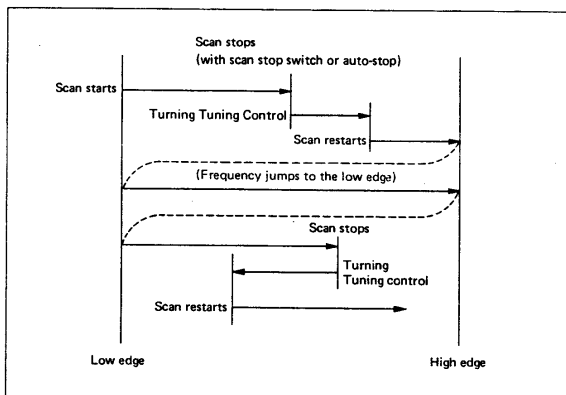

9. The scanning speed can be adjusted by the SCAN SPEED Control located on the driver unit inside cover. Rotating the control clockwise makes the scanning speed faster.

The Tuning Control does not function while the scan is operating.

RECEIVING

Make sure the Volume Control and Power Switch is in the OFF position, then connect the power supply cord to the power connector. The red lead should be connected to the positive side of the power source and the black lead to the negative side. In the event that these leads are improperly connected, the transceiver will not function. Reversing polarity will blow out the fuse in the power supply cord due to actuation of the protective circuit.

Connect the microphone to the MIC Connector.

Connect the antenna to the Antenna Connector. Make sure the coax line is of the correct impedance (50 ohms) and is neither shorted nor opened.

Set the controls and switches as follows:

Function Switch	"A/B" position
RIT Control	"OFF" position or center (12 o'clock) position
Volume Control and Power Switch	Completely counterclockwise (OFF position)
Squelch Control and RF Power Switch	Completely counterclockwise
VFO/MEMORY Switch	"A" or "B" position

(Others may be at any position or setting.)

Turn the Volume Control and Power Switch clockwise (it will "click" ON) and the meter will illuminate with the frequency display showing "6.010" for 146.010MHz.

Turn the Volume Control clockwise to a comfortable audio level.

If no signal can be heard but only noise, turn the Squelch Control clockwise until the noise from the speaker stops and set it just below this threshold. (When adjusting the Squelch Control setting, if some communication signals can be heard, turn the tuning control either direction and set it where only noise can be heard.)

Turn the tuning control to the desired frequency.

For tuning and Memory Channel operation refer to "HOW TO TUNE" on page 12 and "MEMORY CHANNEL OPERATION" on page 15.

TRANSMITTING

For simplex operation, set ① FUNCTION Switch in the "SIM" position or "A/B" position.

The operating frequency is selectable with the VFO/MEMORY Switch and the Tuning Control knob.

For repeater operation, set ① FUNCTION Switch in the "DUP-N", "DUP-R" or "A-B" position.

In the "DUP-N" position, the transmitting frequency is 600KHz below the receiving frequency.

In the "DUP-R" position, the transmitting frequency is 600KHz above the receiving frequency.

The receiving frequency can be selected by any position of the VFO/MEMORY Switch.

In the "A-B" position, the receiving frequency is selected by the "A" VFO or "B" VFO, and the transmitting frequency is selected by the other VFO, thus you can access any repeater that has any amount of frequency separation from 5KHz to 4MHz.

For more details refer to "HOW TO TUNE" on page 12 and "MEMORY CHANNEL OPERATION" on page 15.

If the lower output power (1 watt) is sufficient, set ① Squelch Control and RF Power Switch to the LOW (out) position.

Depress the PTT (push to talk) Switch on the microphone and the transceiver will transmit. At the same time the TRANSMIT indicator will be illuminated red and the meter will provide an indication of relative power output of the transmitter.

SECTION VI INSIDE VIEW

MAIN UNIT SIDE

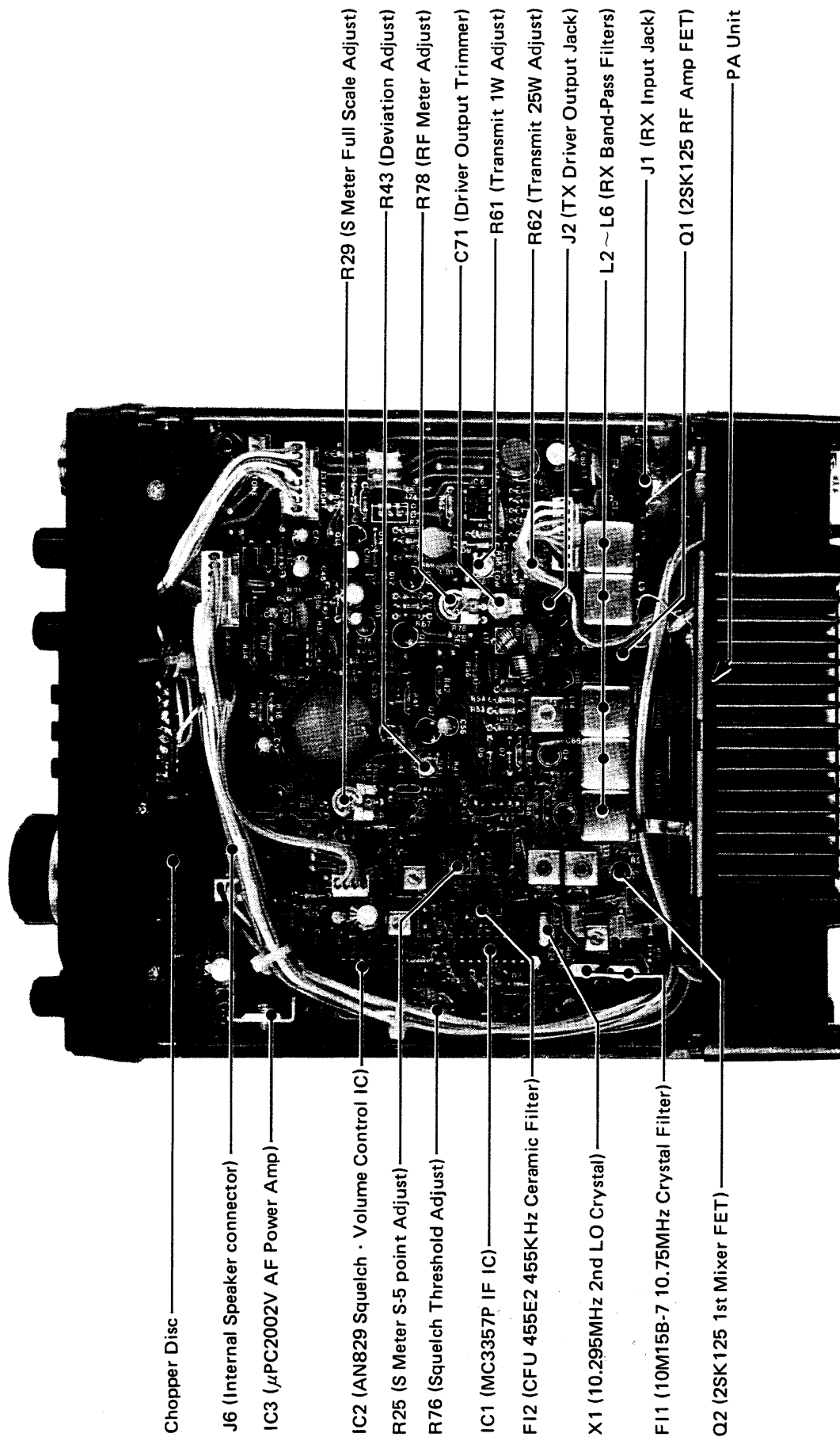

Chopper Disc

J6 (Internal Speaker connector)

IC3 (μ PC2002V AF Power Amp)

IC2 (AN829 Squelch - Volume Control IC)

R25 (S Meter S-5 point Adjust)

R76 (Squelch Threshold Adjust)

IC1 (MC3357P IF IC)

F12 (CFU 455E2 455KHz Ceramic Filter)

X1 (10.295MHz 2nd LO Crystal)

F11 (10M15B-7 10.75MHz Crystal Filter)

Q2 (2SK125 1st Mixer FET)

R29 (S Meter Full Scale Adjust)

R43 (Deviation Adjust)

R78 (RF Meter Adjust)

C71 (Driver Output Trimmer)

R61 (Transmit 1W Adjust)

R62 (Transmit 25W Adjust)

J2 (TX Driver Output Jack)

L2 ~ L6 (RX Band-Pass Filters)

J1 (RX Input Jack)

Q1 (2SK125 RF Amp FET)

PA Unit

DRIVER UNIT SIDE

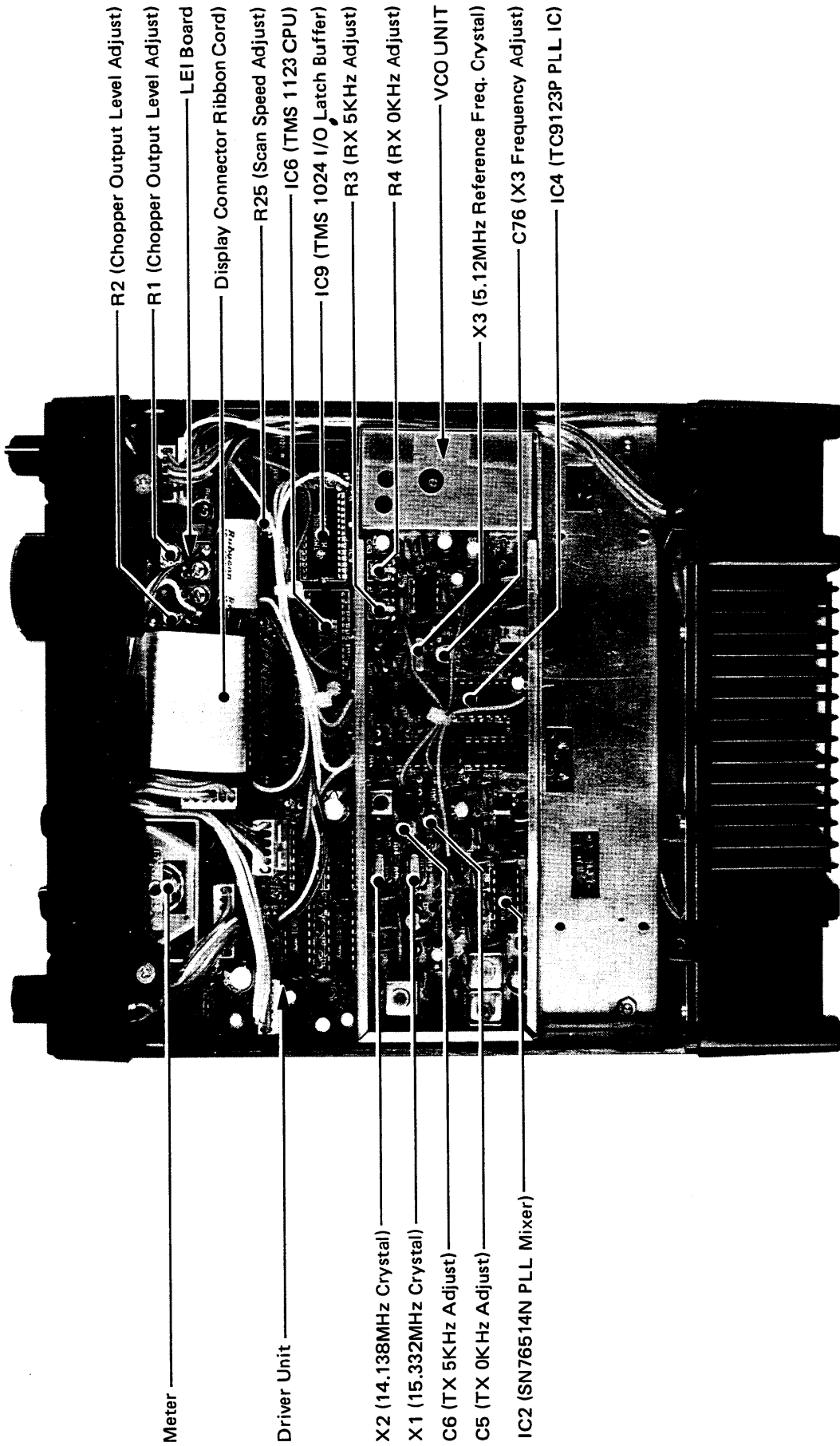

- Meter
- Driver Unit
- X2 (14.138MHz Crystal)
- X1 (15.332MHz Crystal)
- C6 (TX 5KHz Adjust)
- C5 (TX 0KHz Adjust)
- IC2 (SN76514N PLL Mixer)
- R2 (Chopper Output Level Adjust)
- R1 (Chopper Output Level Adjust)
- Display Connector Ribbon Cord
- R25 (Scan Speed Adjust)
- IC6 (TMS 1123 CPU)
- IC9 (TMS 1024 I/O Latch Buffer)
- R3 (RX 5KHz Adjust)
- R4 (RX 0KHz Adjust)
- VCO UNIT
- X3 (5.12MHz Reference Freq. Crystal)
- C76 (X3 Frequency Adjust)
- IC4 (TC9123P PLL IC)

SECTION VII TROUBLE SHOOTING

Your IC-255A has been tested very carefully at the factory before shipping. The chart below has been designed to help you correct any problems which are not equipment malfunctions. If you are not able to locate the problem and/or solve it through use of this chart, please contact your dealer or ICOM distributor for assistance..

Problem	Possible Cause	Solution
1. Power does not come ON when the switch is turned.	Power cord is improperly connected. Power cord is connected with the polarity reversed. Blown fuse.	Carefully reconnect power cord. Disconnect the power cord, replace the blown fuse, then reconnect the power cord observing proper polarity. Check for the cause, then replace the fuse with a new one.
2. No sound comes from the speaker.	VOLUME Control knob is completely counterclockwise, but not "clicked OFF". The unit is in the transmit mode, by the PTT switch on the microphone. SQUELCH setting is turned too far clockwise. External speaker is in use. The internal speaker cable is not connected.	Turn the knob clockwise to a suitable level. Put the unit in the receive mode. Turn the SQUELCH control counterclockwise until noise can be heard and reset it just below the threshold. Check if the external speaker plug is inserted properly or if the external speaker cable is cut. Connect the speaker connection.
3. Sensitivity is low and only strong signals are audible.	The antenna feed line is cut or shorted.	Check the feed line and correct any improper condition.
4. No or low RF output.	RF Power switch is set at the Low position. PTT switch is not functioning due to bad connection of the MIC connector. The antenna feeder is cut or shorted.	Set the RF Power switch to the High (normal) position. Check the connection of the MIC connector and correct any problems. Check the antenna feeder and correct any problems.
5. No modulation.	Bad connection of the MIC connector. The MIC cable is cut.	Check the connection of the MIC connector and correct any problems. Repair the disconnected or cut wire.

Problem	Possible Cause	Solution
6. The frequency does not change by rotating the Tuning knob.	VFO/MEMORY Switch is set in one of the memory channels.	Set the VFO/MEMORY Switch to the "A" or "B" position.
7. The receive mode functions properly and your signals are transmitted, but you are unable to make contact with another station. (When desiring SIMPLEX mode.) (When desiring DUPLEX mode.)	<p>The FUNCTION Switch is in the DUP-N, DUP-R or A-B position.</p> <p>The receive frequency is off set from the transmit frequency by the RIT control.</p> <p>The FUNCTION Switch is in the A/B or SIM position.</p> <p>Improper frequency split or input/output frequency of the repeater.</p>	<p>Set the FUNCTION Switch to the A/B or SIM position.</p> <p>Turn OFF the RIT, or set the RIT control knob to the center (12 o'clock) position.</p> <p>Set the FUNCTION Switch to the DUP-N, DUP-R or A-B position.</p> <p>Set the proper frequency split and turn the FUNCTION Switch to the DUP-N, DUP-R or A-B position according to repeater input/output frequency.</p>
8. The memorized frequencies are lost and the display shows 6.010 when the power switch is turned ON.	<p>The memory switch was turned OFF.</p> <p>The main switch of the power source was turned OFF or the power plug was unplugged.</p> <p>The power failed (when using the AC power source).</p>	<p>Turn ON the memory switch on the rear panel.</p> <p>Use the continuous operating power source or optional memory power source.</p>
9. The memory scan operation does not function when the S/S Switch is pushed.	<p>No frequency is programmed in the memory channels or the same frequency is programmed in all the memory channels.</p> <p>The VFO/MEMORY Switch is not in the memory channels.</p>	<p>Program the required frequencies in the memory channels following the instructions for "MEMORY CHANNEL OPERATION" on page 15.</p> <p>Set the VFO/MEMORY Switch in one of the memory channels.</p>
10. The programmed scan operation does not function when the S/S Switch is pushed.	<p>No frequency is programmed or the same frequency is programmed in the memory channels ① and ②.</p> <p>The VFO/MEMORY Switch is not in the A or B position.</p>	<p>Program the low edge and the high edge frequencies into the memory channels ① and ②.</p> <p>Set the VFO/MEMORY Switch in the A or B position.</p>
11. The scan does not stop even if a signal is received.	The squelch has opened when the scan started.	Engage the squelch on a no signal frequency, then start the scan by pressing the S/S Switch.

SECTION IX VOLTAGE CHARTS

NOTE: Measuring instrument is a 50K Ω /V multimeter.

MAIN UNIT TRANSISTORS

TR No.	TRANSMIT				RECEIVE				REMARKS
	BASE OR GATE1	GATE2	COLLECTOR OR DRAIN	EMITTER OR SOURCE	BASE OR GATE1	GATE2	COLLECTOR OR DRAIN	EMITTER OR SOURCE	
Q 1	GND		0	0.1	GND		7.7	0.7	
Q 2	0		0.1	0.1	0		7.9	2.6	
Q 3	0.6		0	GND	0		6.2	GND	Squelch opened
Q 4	0		0.25	GND	0		9.0	GND	
Q 5	0		0	0	0		1.4	0	
Q 6	0		0	0.2	0.1		9.0	0	
Q 7	3.4		8.7	2.8	0		0	0	
Q 8	0		0.2	GND	0.6		3.8	GND	
Q 9	0.7		6.4	GND	0.6		0	GND	
Q10	0.2		7.2	GND	0.7		0	GND	
Q11	0.8		13.8	0.3	9.6		11.4	9.0	
Q12	9.6		10.8	9.0	9.0		11.4	9.0	
Q13	9.6		13.0	9.1	0		13.8	0	
Q14	0.1		9.7	GND	0.7		0.1	GND	

MAIN UNIT IC IN TRANSMIT MODE

IC No.	PIN No.																REMARKS
	1	2	3	4	5	6	7	8	9	10	11	12	13	14	15	16	
IC1	0.1	0	0.2	0.7	0	0	0	0.2	0	0	0	0	0	0	GND	0.1	
IC2	1.0	0	3.8	GND	9.2	2.5	0	1.2	5.5	4.6	0	7.0	0.6	0			
IC3	0.3	0.6	GND	5.8	13.8												
IC4	0	0	0	GND	0.2	0	0.3										
IC5	3.5	3.4	3.3	GND	0	0	5.8	6.3									
IC6	1.2	9.0	4.0	GND	3.8	3.9	7.8	12.0									Output High
IC6	1.2	9.0	4.0	GND	3.8	3.9	10.5	13.8									Output Low

MAIN UNIT IC IN RECEIVE MODE

IC No.	PIN No.																REMARKS
	1	2	3	4	5	6	7	8	9	10	11	12	13	14	15	16	
IC1	5.6	5.2	5.6	5.8	0.8	0.8	1.0	5.8	3.5	1.8	1.8	0	5.4	0	GND	1.8	
IC2	1.0	4.4	3.8	GND	9.4	2.5	0	1.2	5.7	4.6	0	7.0	1.2	0			Squelch opened
IC2	1.0	4.4	3.8	GND	9.3	4.6	0	1.2	5.7	4.8	0	7.1	0.7	0			Squelch closed
IC3	0.3	0.5	GND	5.7	13.8												
IC4	4.0	1.0	1.4	GND	5.0	2.2	4.9										
IC5	0	0	0	GND	0	0	0	0									
IC6	11.0	0	4.0	GND	10.2	4.0	12.0	13.8									

PLL UNIT TRANSISTORS (When the operating frequency is 145.000MHz.)

TR No.	TRANSMIT				RECEIVE				REMARKS
	BASE OR GATE1	GATE2	COLLECTOR OR DRAIN	EMITTER OR SOURCE	BASE OR GATE1	GATE2	COLLECTOR OR DRAIN	EMITTER OR SOURCE	
Q 1	8.8		2.8	9.3	8.8		2.8	9.3	
Q 2	0.55		0	GND	0.6		0	GND	
Q 3	4.0		6.5	3.5	4.0		6.5	3.6	
Q 4	1.5		8.8	1.55	1.45		8.8	1.55	
Q 5	1.5		8.8	2.0	1.5		8.8	2.3	
Q 6	3.5		5.0	0.15	3.5		5.0	0.15	
Q 7	1.6		7.0	1.1	1.65		7.0	1.05	
Q 8	GND		7.4	1.95	GND		7.4	1.95	
Q 9	1.1		6.5	0.4	1.1		6.2	0.4	
Q10	1.2		7.8	0.55	1.2		7.8	0.55	
Q11	9.0		8.6	9.3	9.0		9.3	9.3	
Q12	8.6		9.2	9.3	9.3		0	9.3	

PLL UNIT IC

IC No.	PIN No.																REMARKS
	1	2	3	4	5	6	7	8	9	10	11	12	13	14	15	16	
IC1	6.1	3.1	4.2	GND	4.4	4.4	4.2	9.0									
IC2	—	8.8	7.7	4.4	3.0	GND	—	—	3.0	4.4	4.4	4.4	7.8	—			
IC3	1.3	1.3	GND	8.2	8.8												
IC5	*	*	*	*	*	*	GND	*	*	*	*	*	*	9.3			
IC6	*	*	0	9.3	0	9.3	GND	0	9.3	0	9.3	*	*	9.3			
IC4	GND	*	*	*	*	*	*	*	*	*	0.2	2.4	8.1	6.6	0	4.4	
	PIN No.																
	17	18	19	20	21	22											
0	8.6	4.3	3.3	3.6	8.6												

NOTE:

Other devices work in C-MOS level and with pulse signals, so the voltages can not be measured with a 50KΩ/V multimeter.

The function of the CPU is identified with reading the relationship between the R output and the K input signals.

The relationship between the R output and the K input signals can be checked with a dual trace oscilloscope, and also the level of these signals can be measured with the scope.

The driver unit consists of several C-MOS IC's and P-MOS IC's. P-MOS IC's are IC6 TMS1123 CPU and IC9 TMS1024 I/O port, and the others are C-MOS IC's.

Refer to the threshold level chart on next page for measuring these levels.

R OUTPUT TIMING CHART

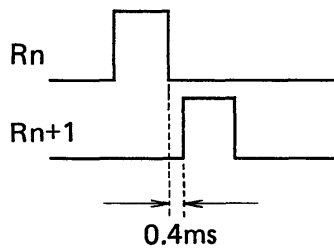
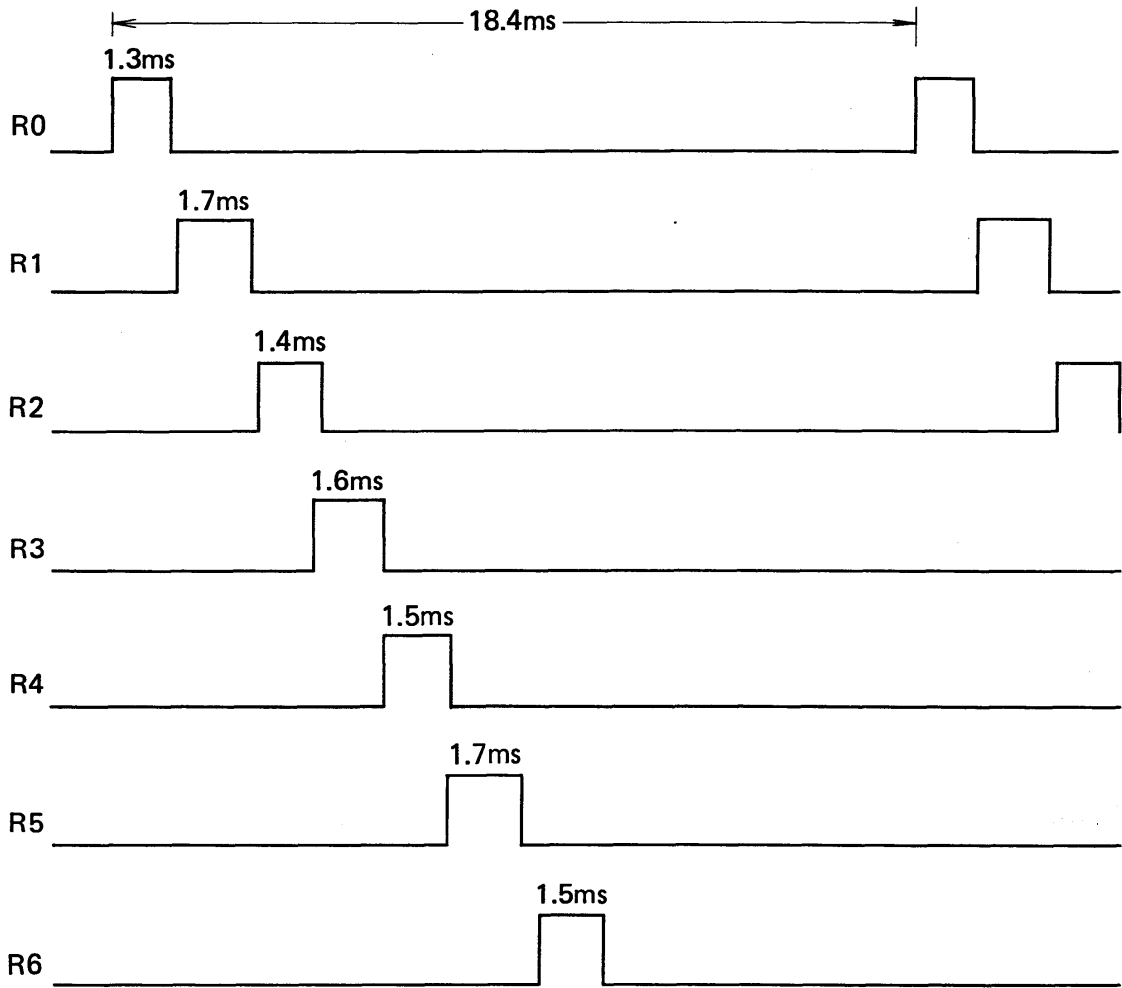

Each R output has a 0.4 milliseconds interval.

THRESHOLD LEVEL CHART

C-MOS IC

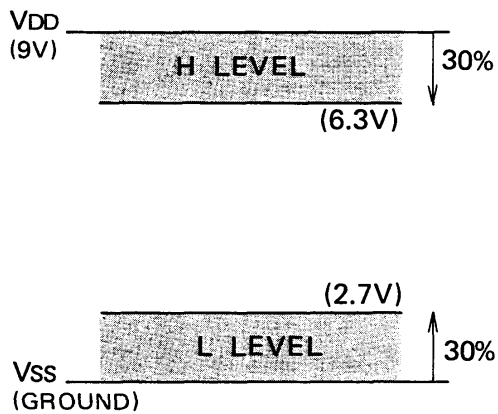

P-MOS IC

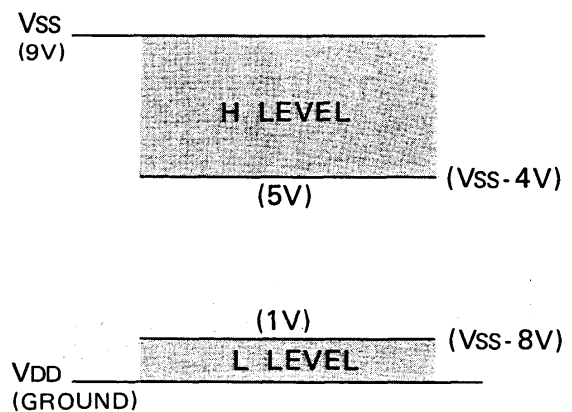

SECTION X BLOCK DIAGRAM

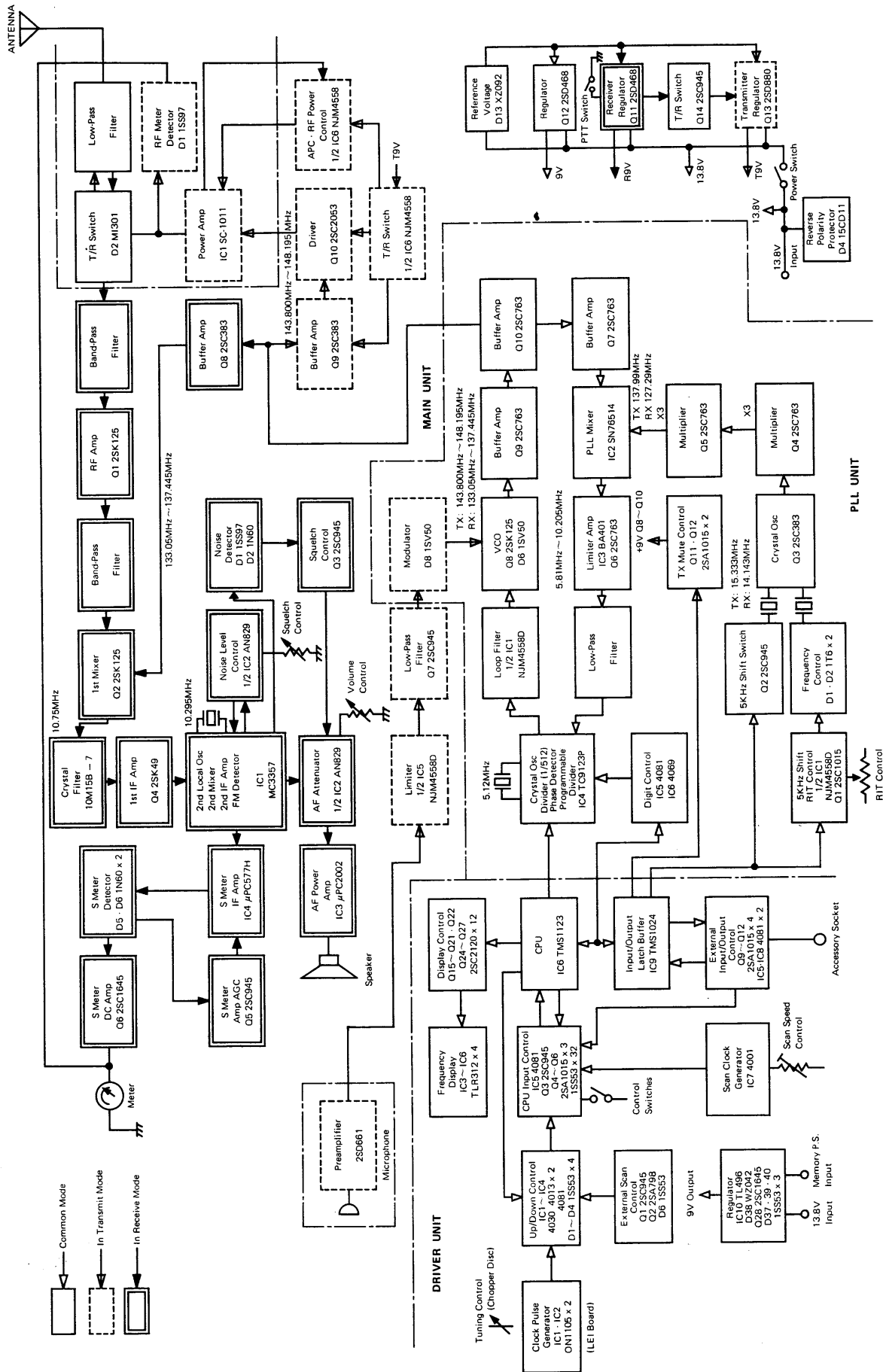

MEMO

A series of horizontal dashed lines for writing.



ICOM INCORPORATED

1-6-19, KAMI KURATSUKURI, HIRANO-KU,
OSAKA JAPAN