

IC-38A

220MHz FM TRANSCEIVER

INSTRUCTION MANUAL



FOREWORD

Congratulations for choosing this technically-advanced ICOM product.

The IC-38A VHF FM transceiver is the latest addition to the ICOM system of Amateur radio equipment. Included in the IC-38A design is provision for use of the newly developed Digital Code Squelch System. Digital Code Squelch uses the latest digital techniques to create a communications system capable of dramatically reducing the inconvenience of heavily populated Amateur bands.

Use the IC-38A with the knowledge that this transceiver, and every ICOM product, is supported by a world-wide network of authorized service centers and dealers ready to provide assistance efficiently.

UNPACKING

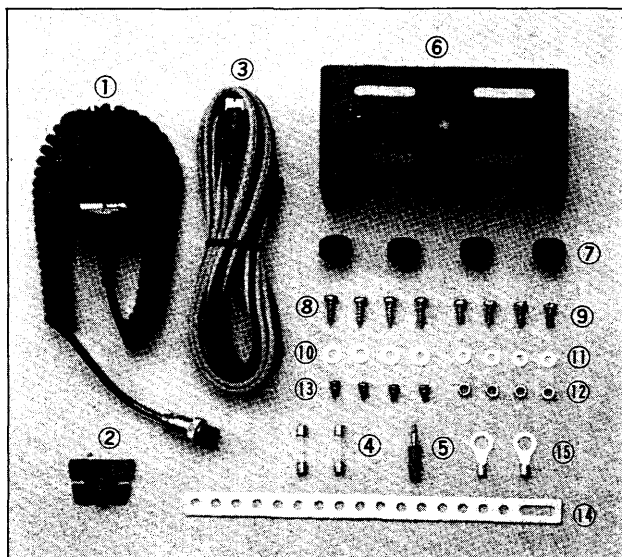

IC-38A ACCESSORIES SUPPLIED	QTY.
1. Microphone (HM-12)	1
2. Microphone hanger	1
3. Power cable	1
4. Fuses (15A)	2
5. External speaker plug.	1
6. Mounting bracket	1
7. Mounting bracket knobs	4
8. Mounting screws (self-tapping)	4
9. Mounting screws	4
10. Flat washers (large)	4
11. Flat washers (small).	4
12. Nuts	4
13. Screws/spring washers	4
14. Support bracket.	1
15. Cable lugs	2

TABLE OF CONTENTS

SECTION	1	SPECIFICATIONS	1
	1-1	GENERAL	1
	1-2	TRANSMITTER.....	1
	1-3	RECEIVER.....	1
SECTION	2	CONTROL FUNCTIONS	2
	2-1	FRONT PANEL	2
	2-2	LCD READOUT	5
	2-3	REAR PANEL.....	7
SECTION	3	INSTALLATION	8
	3-1	MOBILE INSTALLATION.....	8
	3-2	FIXED INSTALLATION.....	10
SECTION	4	OPERATION	12
	4-1	BASIC OPERATION	12
	4-2	MEMORY MODE.....	14
	4-3	SCAN FUNCTIONS.....	16
	4-4	DUPLEX MODE	18
	4-5	MICROPHONE.....	21
	4-6	BACKUP BATTERY.....	21
	4-7	RESETTING INTERNAL MICROCOMPUTER (CPU).....	22
SECTION	5	INSIDE VIEWS	23
	5-1	TOP VIEW (MAIN UNIT).....	23
	5-2	BOTTOM VIEW (RX UNIT).....	23
SECTION	6	MAINTENANCE	24
SECTION	7	BLOCK DIAGRAM	26
SECTION	8	OPTIONS	27
SECTION	9	SCHEMATIC DIAGRAM	SEPARATE

SECTION 1 SPECIFICATIONS

1 - 1 GENERAL

Frequency coverage	GUARANTEED RANGE		OPERATION RANGE	
	TRANSCIVER		RECEIVER	TRANSMITTER
	220 ~ 225MHz		215 ~ 230MHz	220 ~ 225MHz

Frequency resolution : 5, 10, 15, 20 or 25kHz (programmable)

Frequency control : CPU based 5kHz
Simplex and semi-duplex capability (programmable offset)

Memory channels : 21 channels

Usable temperature range : $-10^{\circ}\text{C} \sim +60^{\circ}\text{C}$ ($+14^{\circ}\text{F} \sim +140^{\circ}\text{F}$)

Power supply requirement : 13.8V DC $\pm 15\%$ (negative ground)
AC power supply is available for AC operation.

Current drain (at 13.8V DC) : Transmit

HIGH (25W)	Maximum	6.5A
LOW (5W)	Approx.	3.0A

 Receive

Max. audio output	Approx.	800mA
Squelched	Approx.	450mA

Antenna impedance : 50 ohms unbalanced

Dimensions : 140(140)mm(W) x 50(50)mm(H) x 155(171)mm(D)
Bracketed values include projections.

Weight : 1.2kg

1 - 2 TRANSMITTER

Output power	: HIGH 25W LOW 5W
Emission mode	: 16K0F3E (16K0F2D: When operating with an optional UT-28)
Modulation system	: Variable reactance frequency modulation
Max. frequency deviation	: $\pm 5.0\text{kHz}$
Spurious emission	: More than 60dB below carrier
Microphone	: 600 ohm electret condenser with push-to-talk and scanning switches

1 - 3 RECEIVER

Receive system	: Double-conversion superheterodyne
Modulation acceptance	: 16K0F3E
Intermediate frequencies	: 1st 17.2MHz 2nd 455kHz
Selectivity	: More than 12.5kHz at -6dB Less than 25.0kHz at -60dB
Sensitivity	: Less than $0.18\mu\text{V}$ for 12dB SINAD
Audio output	: More than 2.4 watts at 10% distortion with 8 ohm load
Audio output impedance	: 4 ~ 8 ohms

*All stated specifications are approximate and subject to change without notice or obligation.

SECTION 2 CONTROL FUNCTIONS

2-1 FRONT PANEL

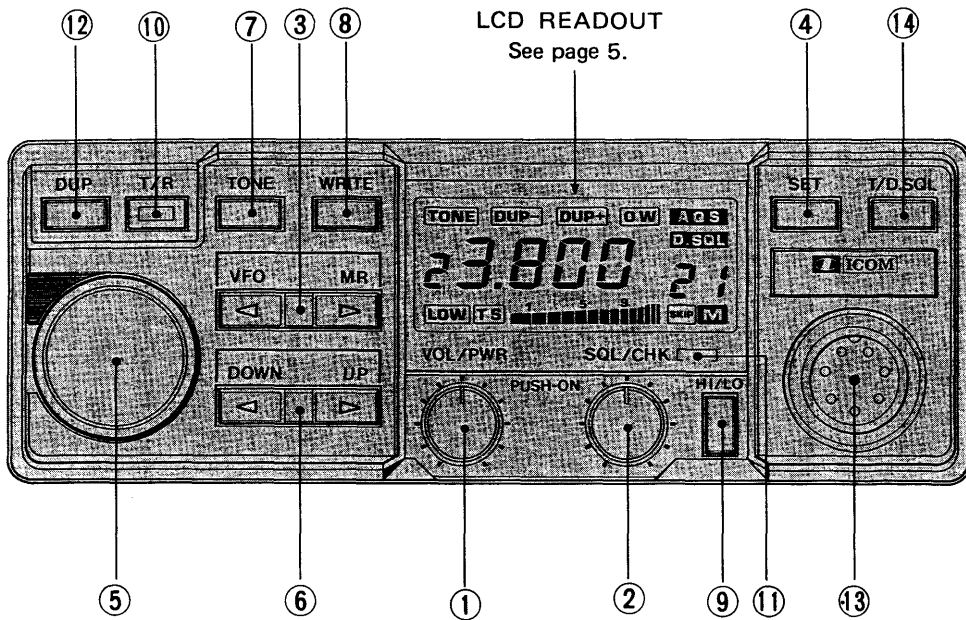

① VOLUME CONTROL/POWER SWITCH [VOL/PWR]

Push this control to turn the power ON and OFF. Turn the control clockwise to increase the audio level.

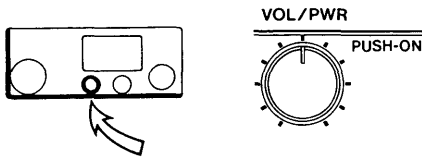

② SQUELCH CONTROL/CHECK SWITCH [SQL/CHK]

The squelch circuit quiets the noise from the transceiver while no signals are being received. While monitoring a vacant channel, turn the control clockwise until the green [T/R] LED goes out.

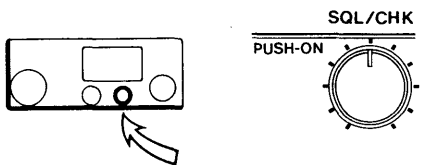

③ VFO/MEMORY READ SWITCH [VFO/MR]

Push to select either the VFO mode or the MEMORY mode of operation. When the MEMORY mode is selected, the letter "M" appears under the memory channel number on the LCD readout.

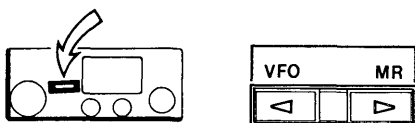

④ SET SWITCH [SET]

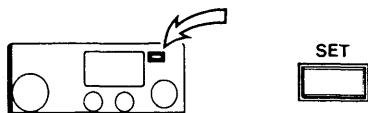

This is a multi-function switch which operates in different ways depending on which mode is currently selected with the IC-38A.

In the VFO mode, the [SET] SWITCH permits programming of the subaudible tone encoder, the transmit offset frequency, and the tuning step size of the TUNING CONTROL. See page 13 for more information.

In the MEMORY mode, the [SET] SWITCH controls the skip function. The skip function allows memory channels to be deleted from the normal scanning sequence when memories are being scanned. See page 18 for more information.

⑤ TUNING CONTROL

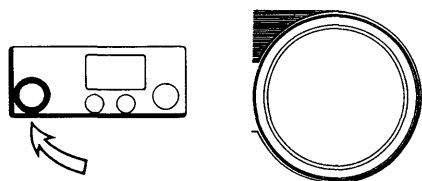

The function of this control is affected by the mode of operation being used.

- In the VFO mode, turn clockwise to increase the operating frequency and counterclockwise to decrease it. After pushing the [SET] SWITCH, the TUNING CONTROL is used to select the subaudible tone number, to set the amount of transmit offset when using the duplex mode, and to select the tuning step size for frequency changes with the TUNING CONTROL.

- In the MEMORY mode, turn clockwise to increase the selected memory channel and counterclockwise to decrease it. See page 14 for more information.

⑥ DOWN/UP SWITCH [DOWN/UP]

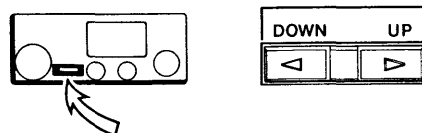

This switch operates differently depending on the setting of the [VFO/MR] SWITCH.

- In the VFO mode, push to change the selected operating frequency in 1MHz increments.

- In the MEMORY mode, push to change the selected memory channel in one channel increments.

⑦ TONE SWITCH [TONE]

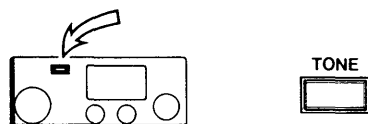

Push to turn ON and OFF the subaudible tone encoder when using the duplex mode.

- The word "TONE" appears when the tone encoder is turned ON. See page 20 PROGRAMMING THE SUBAUDIBLE TONE FREQUENCY.

⑧ WRITE SWITCH [WRITE]

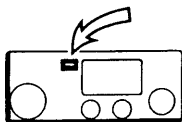

This switch works differently depending on the setting of the [VFO/MR] SWITCH.

- In the VFO mode, push to store the displayed frequency on the LCD readout in the memory channel represented by the memory channel number also displayed. See page 15 MEMORY PROGRAMMING.
- In the MEMORY mode, push to transfer the displayed frequency, which is the contents of the selected memory channel to the VFO. After the transfer, the IC-38A changes to the VFO mode. See page 16 for more information.

⑨ HIGH/LOW SWITCH [HI/LO]

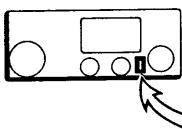

Push to change between the HIGH (25W) and LOW (5W) transmit output power. The word "LOW" appears when LOW power is selected.

⑩ TRANSMIT/RECEIVE INDICATOR [T/R]

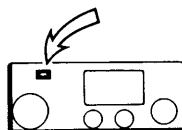

This two-color LED indicates whether the IC-38A is in the transmit or receive mode. The LED is red while transmitting and green while receiving with the squelch circuit open. The indicator is OFF when the squelch circuit is closed and the receiver is muted.

⑪ DISPLAY DIMMER SENSOR

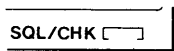
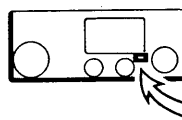

This sensor measures ambient light and controls the dimmer circuit which varies the intensity of the LCD backlighting.

⑫ DUPLEX SWITCH [DUP]

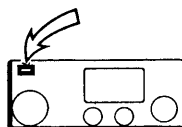

Push to select simplex or duplex operation:

- The transmit frequency is LOWER than the receive frequency by 1.6MHz or by the programmed offset amount when "DUP-" appears on the display.
- The transmit frequency is HIGHER than the receive frequency by 1.6MHz or by the programmed offset amount when "DUP+" appears on the display.
- When neither "DUP-" nor "DUP+" appear on the display, the IC-38A is in the simplex mode. The transmit and receive frequencies are equal at this time.

⑬ MIC CONNECTOR

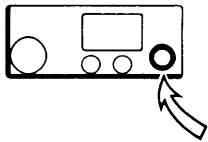

Connect the supplied microphone to this connector. Refer to SECTION 8 OPTIONS for optional microphones.

FRONT VIEW

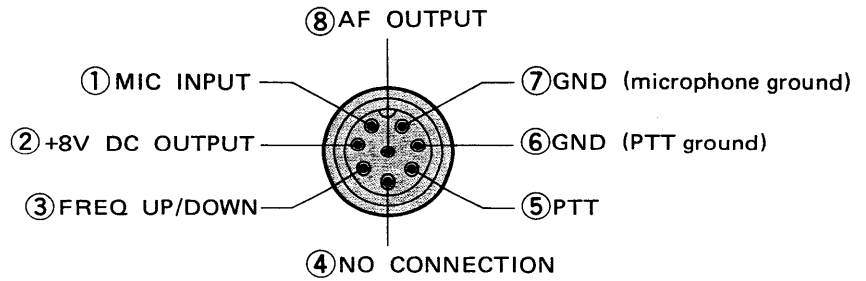

⑭ TONE SQUELCH SWITCH DIGITAL SQUELCH SWITCH [T/D.SQL]

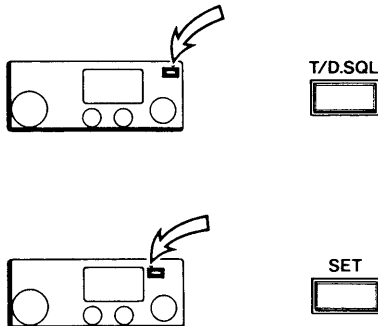

This switch turns ON and OFF the optional squelch systems:

NOTE: This switch has no function when neither option is installed.

- **DIGITAL CODE SQUELCH SYSTEM (UT-28)**
When activated, "D.SQL" appears on the display. Push the [SET] SWITCH in order to program the desired group code.
- **TONE SQUELCH SYSTEM (UT-29)**
When activated, "TONE" and "D.SQL" appear on the display. Push the [SET] SWITCH in order to program the desired subaudible tone numbers.

2 - 2 LCD READOUT

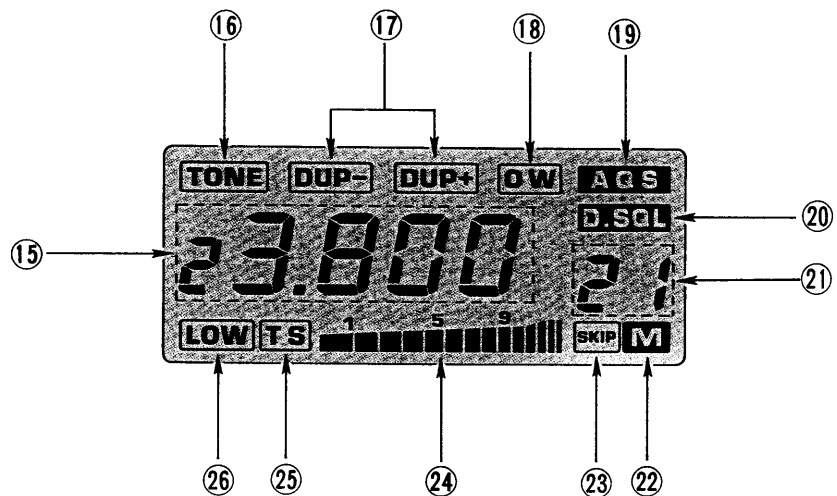

⑮ FREQUENCY

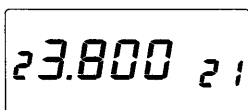

The operating frequency is displayed with digits representing the 10MHz, 1MHz, 100kHz, 10kHz and 1kHz positions.

The decimal point on the display flashes during scanning operations. Also, the subaudible tone number, the transmit offset, the tuning step size, and the group code for the optional digital code squelch are displayed on the LCD readout.

⑩ SUBAUDIBLE TONE INDICATOR "TONE"

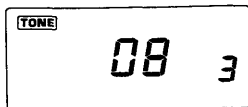

Appears when the subaudible tone encoder is activated. Also, appears when the optional UT-29 Tone Squelch unit is activated. See page 20 for PROGRAMMING THE SUBAUDIBLE TONE FREQUENCY.

⑪ DUPLEX MODE INDICATORS "DUP-, DUP+"

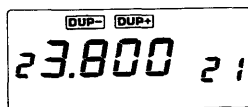

Appear while the IC-38A is being operated in the duplex mode (the transmit frequency is different from the receive frequency). Both indicators disappear while operating in the simplex mode. See page 18 for DUPLEX MODE information.

⑫ OFFSET WRITE INDICATOR "OW"

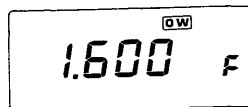

Flashes when the IC-38A is ready to have the transmit offset programmed for duplex operation. See page 18 DUPLEX MODE for more information.

⑬ GROUP CODE INDICATOR "AQS"

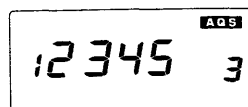

Flashes when the IC-38A is ready to have the group code programmed when using the optional UT-28 Digital Code Squelch unit.

NOTE: The "AQS" indicator does not appear if the optional UT-28 is not installed.

⑭ SQUELCH SYSTEM INDICATOR "D.SQL"

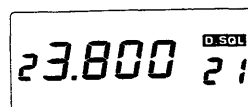

Appears when either the optional tone squelch or optional digital code squelch system is activated. Flashes with the "TONE" INDICATOR when the IC-38A is ready to have the subaudible tone number for the tone squelch programmed.

NOTE: The "D.SQL" indicator does not appear if the optional UT-28 or UT-29 is not installed.

⑮ MEMORY CHANNEL NUMBER

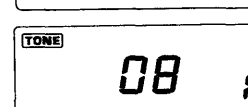
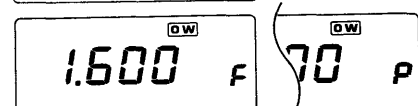
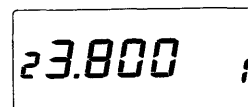

This area displays various symbols:

- Select memory channels "1" to "21".
- Offset programming symbol "F" or "P"
- Subaudible tone encoder memory number "1", "2" or "3".

⑯ MEMORY MODE INDICATOR "M"

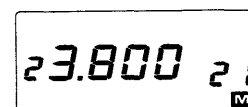

Appears when the MEMORY mode is selected with the [VFO/MR] SWITCH. See page 14 MEMORY MODE for more information.

⑳ MEMORY CHANNEL SKIP INDICATOR "SKIP"

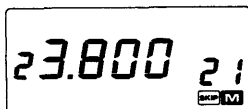

Appears when a particular memory channel has been programmed with the [SET] SWITCH to be excluded from the memory scan operation. See page 18 MEMORY SKIP FUNCTION for more information.

㉑ "S/RF" INDICATOR

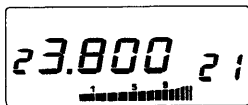

In the receive mode, this indicator operates as an S-meter showing the receive signal level. In the transmit mode, the relative output power of the transmitter is indicated as follows:

- LOW power : 5 segments appear.
- HIGH power : All segments appear.

㉒ TUNING STEP INDICATOR "TS"

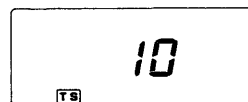

Flashes when the IC-38A is ready for programming of the VFO step size. Use the TUNING CONTROL to select a desired step size.

㉓ OUTPUT POWER INDICATOR "LOW"

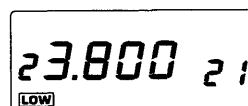

Appears when LOW power is selected with the [HI/LO] SWITCH. The indicator does not appear when HIGH power is used.

2-3 REAR PANEL

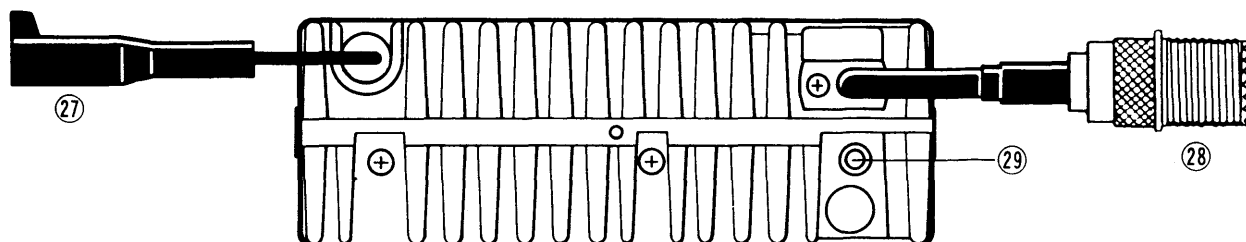

㉗ POWER CONNECTOR

Connect 13.8V DC $\pm 15\%$ from a stable power source to this connector.

㉘ ANTENNA CONNECTOR

Connect a 50 ohm antenna with a PL-259 connector on the feedline to this connector.

㉙ EXTERNAL SPEAKER JACK

Connect a 4 ~ 8 ohm speaker to this jack, if required. Connecting the external speaker automatically disconnects the internal speaker.

SECTION 3 INSTALLATION

3-1 MOBILE INSTALLATION

(1) INSTALLATION

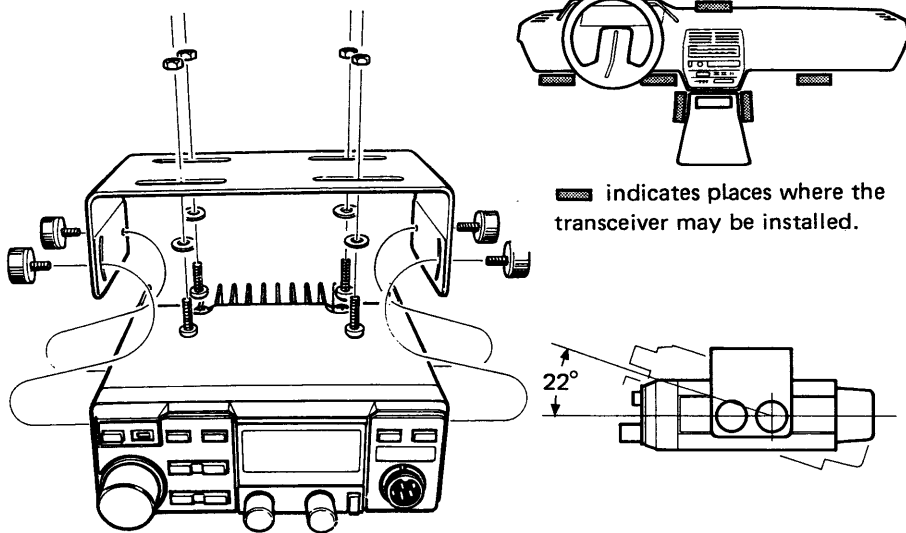

- Avoid locations where hot or cold air can blow directly on the unit or where there are large temperature variations.
- Avoid mounting the transceiver where it will hinder the normal operation of the vehicle.
- Securely mount the transceiver with the supplied bracket to minimize vibration.

(2) CONNECTIONS

NOTE:
 Insulate the power cable using rubber or electrician's tape where it passes through holes in the vehicle body.

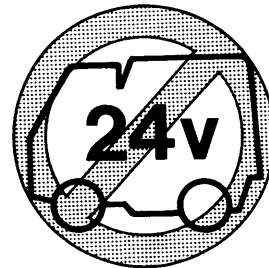
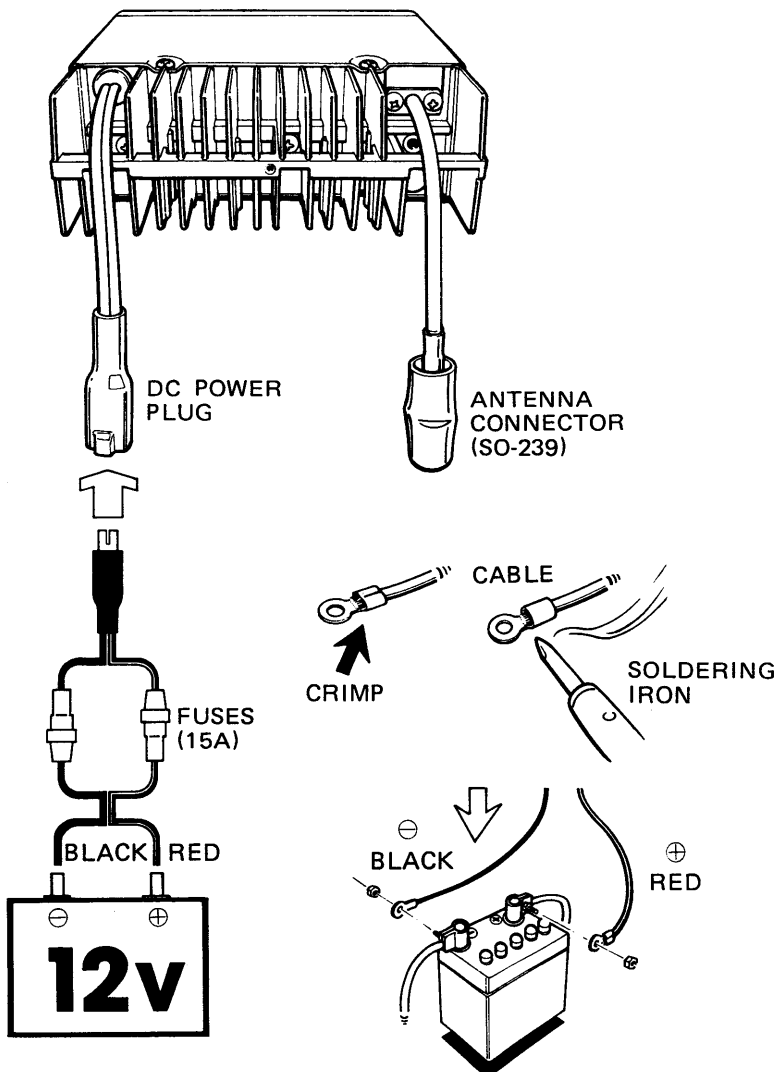

- Do not connect directly to a 24V battery.

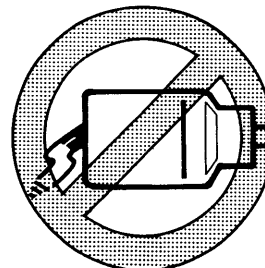

- Do not use the cigarette lighter socket for power connections.

(3) ANTENNA

Transceiver performance largely depends on the quality of the antenna used. Select a high-quality antenna and use it as recommended by the manufacturer.

(4) COAXIAL CABLE

Use a large diameter 50 ohm coaxial cable. The added efficiency of the large cable is important in the VHF spectrum to reduce cable loss.

(5) ANTENNA LOCATION

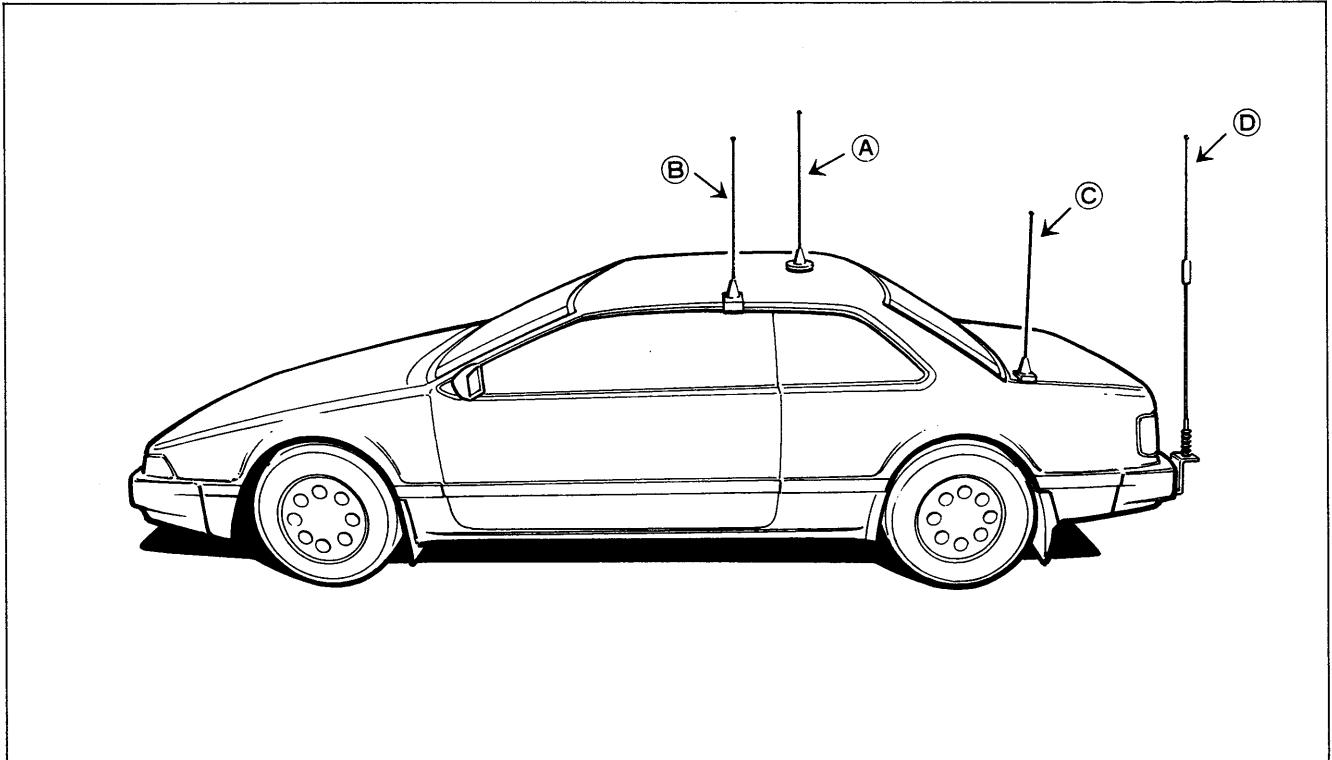

- A: Roof-mount antenna
 - Best location for a good radiation pattern.
 - Drill a hole in the roof, or use a magnetic antenna base.
- B: Gutter-mount antenna
- C: Trunk-mount antenna
- D: Bumper-mount antenna
 - Best location for longer antennas.

(6) MICROPHONE

A high-quality electret condenser microphone is supplied with the IC-38A. Plug it directly into the jack on the front panel of the transceiver.

Optional microphones are available for mobile use with the IC-38A.

- IC-HM14: DTMF Microphone
- IC-HM16: Speaker-microphone
- HS-15 : Flexible Mobile Microphone
- HS-15SB: Switch Box for HS-15

(7) EXTERNAL SPEAKER

An external speaker plug is supplied with the IC-38A for use with an optional external speaker if you feel you require one. The external speaker impedance should be 4 ~ 8 ohms. The internal speaker is disconnected when the external speaker is connected.

The SP-10 Mobile Speaker is recommended for mobile use with the IC-38A.

3 - 2 FIXED INSTALLATION

(1) CONNECTIONS

A stable AC power supply with a protective circuit is required for fixed station use.

The PS-45 AC Power Supply is available for operating the IC-38A.

CAUTION: Voltages greater than 16 volts DC will damage your transceiver. Check the source voltage before connecting the power cord.

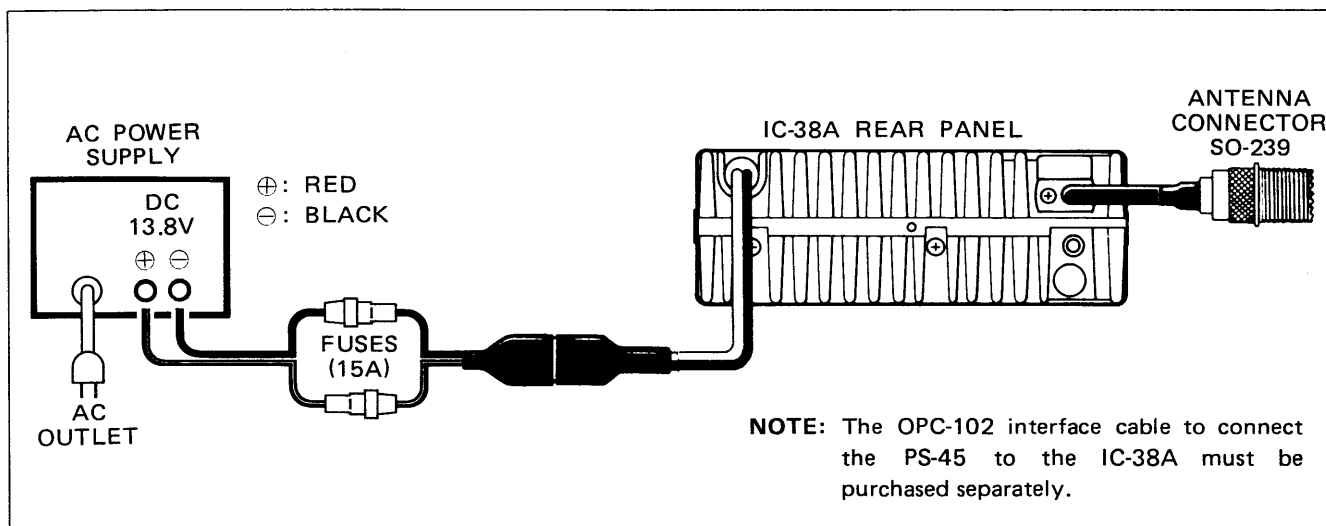

(2) ANTENNA

Antenna performance is crucial for reliable radio communications. For this reason, a 50 ohm directional antenna is well worth the extra investment. A tremendous variety of fixed location antennas is available from various manufacturers. Choose an antenna most suited to your needs.

(3) COAXIAL CABLE

Particularly in a location where feedline lengths are much longer than in a mobile installation, it is best to use a coaxial cable with the lowest loss available.

In the 220MHz band, a 50-foot-length of military grade RG-58A causes a loss of approximately 16 watts due to cable loss when using the IC-38A. An equal length of military grade RG-8A causes only approximately 9 watts loss due to cable loss. Therefore, simply by using a better quality cable, the power reaching the antenna will be about 16 watts instead of 9 watts.

(4) PL-259 CONNECTOR INSTALLATION

A PL-259 connector should be used on the feedline to minimize power loss in the 220MHz band. Follow the instructions below for best results when installing the connector.

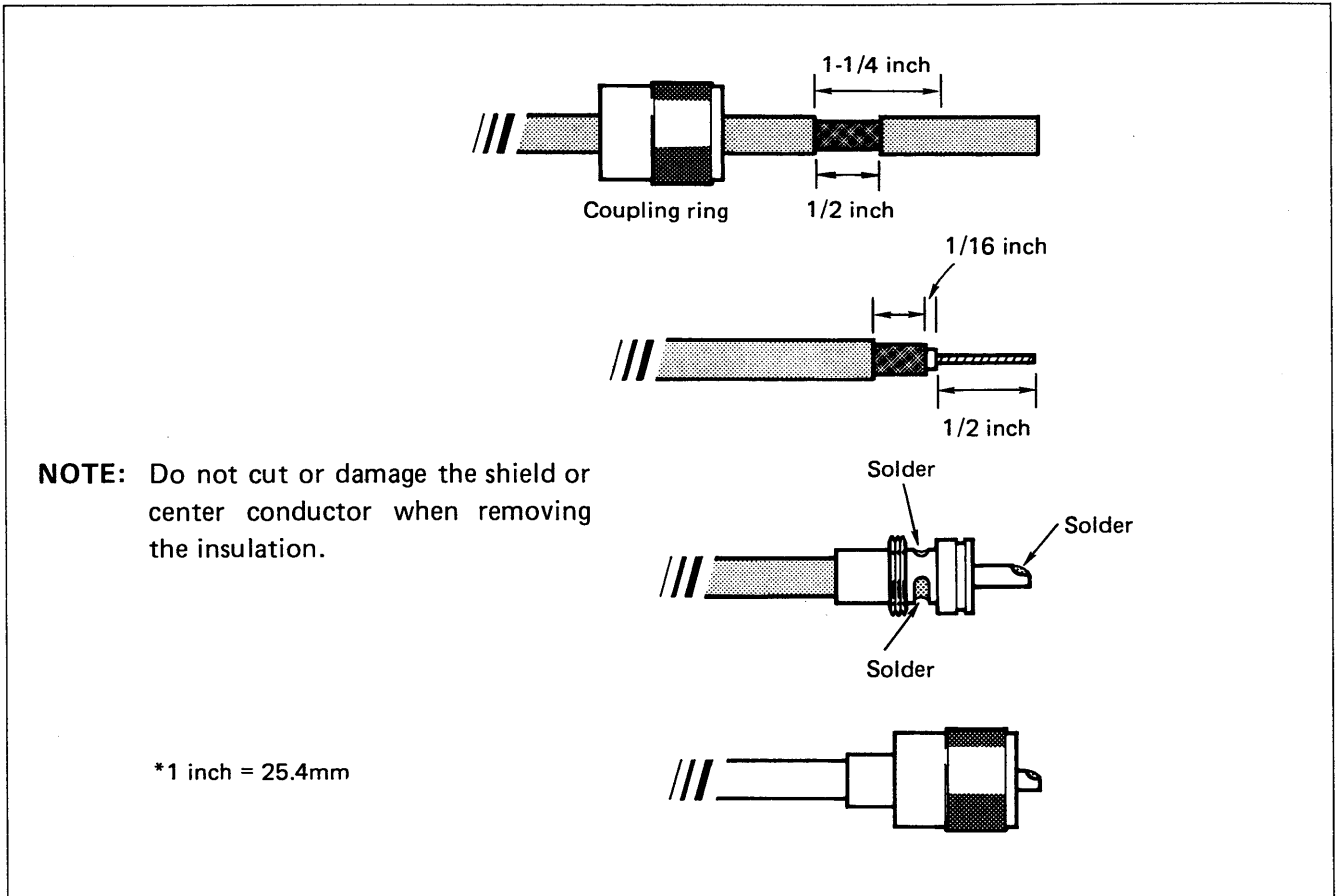

- 1) Slide the coupling ring over the coaxial cable.
- 2) Strip the cable as in the figure, and tin about 1/2" (13mm) of the shield conductor. Remove the outer plastic casing and strip the center conductor insulation as in the figure. Tin the center conductor.
- 3) Slide the connector body onto the cable and solder.
- 4) Screw the coupling ring onto the connector body.

(5) MICROPHONE

In addition to the microphones suggested in SECTION 3 - 1 (6) MICROPHONE on a page 9, also useful for base operation are the following:

- SM-8 : Desk Microphone
- SM-10: Compressor/Graphic Equalizer Microphone

(6) EXTERNAL SPEAKER

In addition to the SP-10 mentioned in SECTION 8 OPTIONS, the SP-7 Base Speaker is another optional speaker which is best for operation from a fixed location.

SECTION 4 OPERATION

4 - 1 BASIC OPERATION

(1) RECEIVING

CONTROL	INITIAL SETTINGS
VOL/PWR	Maximum counterclockwise
SQL/CHK	Maximum counterclockwise

1) Push [VOL/PWR] CONTROL.

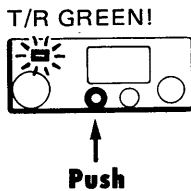

1) Push the VOL/PWR CONTROL to turn ON the power.

- The green [T/R] INDICATOR lights and the LCD READOUT displays the frequency and memory channel number last used.
- If the letter "M" appears on the display below the memory channel number, push the [VFO] side of the [VFO/MR] SWITCH to clear the MEMORY mode.

2) Adjust volume level.



2) Turn the [VOL/PWR] CONTROL clockwise until an adequate sound level is obtained.

3) Adjust squelch level.

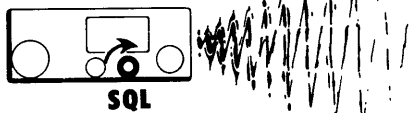

3) Slowly turn the [SQL/CHK] CONTROL clockwise until the received noise is quieted.

- Perform this setting only on a vacant frequency (no received signal).
- The green [T/R] INDICATOR goes out.
- Setting the squelch in this manner mutes all sound from the speaker until a signal is received. On receiving a signal, it opens the squelch circuit and the signal is audible.
- Do not advance the [SQL/CHK] CONTROL beyond the point where the green [T/R] INDICATOR goes out or weak signals will not be heard.

4) Select operating frequency.

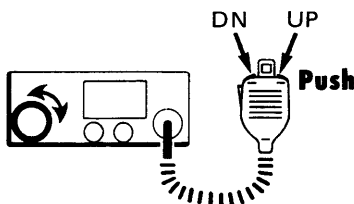

4) Select the desired operating frequency by using either the TUNING CONTROL, or the [UP] or [DN] SWITCH on the microphone.

- When a signal is received, the green [T/R] INDICATOR lights, the "S/RF" INDICATOR displays the signal strength and the audio is heard from the speaker.

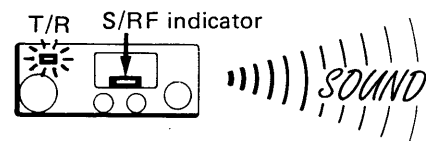

(2) SELECTING A FREQUENCY

(A) USING THE TUNING CONTROL

1) Select the VFO mode.

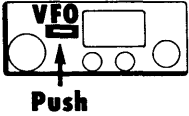

1) Push to select the [VFO] side of the [VFO/MR] SWITCH.

2) Use [DOWN/UP] SWITCH.

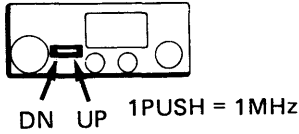

2) Use the [DOWN/UP] SWITCH on the front panel to select the desired MHz range.

- Each time this switch is pushed, the frequency changes by 1MHz down or up.

3) Set tuning step size.

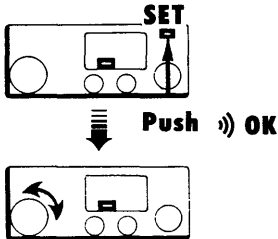

3) Push the [SET] SWITCH repeatedly until the "TS" INDICATOR appears flashing on the display.

- The currently programmed tuning step size also appears: 5, 10, 15, 20 or 25kHz.
- To change the tuning step size, turn the TUNING CONTROL until the desired step size appears.

4) Select VFO mode.

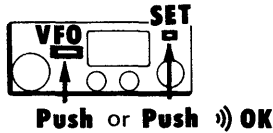

4) Push the [SET] SWITCH or [VFO] side of the [VFO/MR] SWITCH to select the VFO mode.

5) Select frequency.

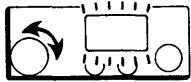

5) Use the TUNING CONTROL to select the exact frequency desired.

- As the TUNING CONTROL is turned, the frequency changes in increments as set in step 3).

(B) USING THE MICROPHONE

1) Select desired MHz range and set tuning step size.

1) Follow steps 1) through 4) under (A) USING THE TUNING CONTROL.

2) Push [UP] or [DN] SWITCH on microphone.

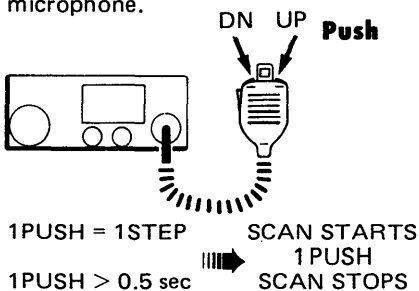

2) Push the [UP] SWITCH or [DN] SWITCH on the microphone until the correct frequency appears on the display.

- Each time the [UP] SWITCH or [DN] SWITCH is pushed, the frequency changes by one increment.
- If these switches are held down for longer than about 1/2 second, the frequency scan function begins. See page 16 FREQUENCY SCANNING for more information.

(3) TRANSMITTING

1) Push and hold [PTT] SWITCH on microphone.

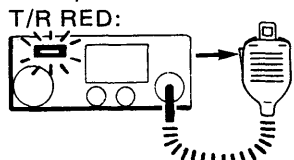

2) Speak into microphone.



3) Release [PTT] SWITCH.

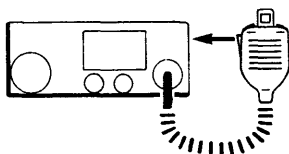

(4) SELECTING OUTPUT POWER



Push \Downarrow OK

NOTE: When using HIGH power, the IC-38A may become warm. This is normal.

4 - 2 MEMORY MODE

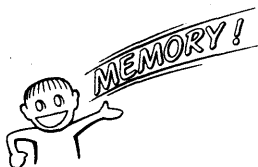

(1) MEMORY READING



Push \Downarrow OK

Ⓐ USING THE TUNING CONTROL



Before transmitting, ensure your transmit frequency is not being used by other stations.

1) Push and hold the [PTT] SWITCH on the microphone to activate the transmitter.

- The red [T/R] INDICATOR lights and the "S/RF" INDICATOR shows the relative output power of the transmitter.

2) Speak into the microphone using your normal voice level.

3) Release the [PTT] SWITCH to stop transmitting.

- The red [T/R] INDICATOR goes out.
- The receive mode is restored.

Push the [HI/LOW] SWITCH to alternately change between HIGH and LOW transmit power.

- When the LOW power is selected, the "LOW" INDICATOR appears on the display.

HIGH POWER: 25W

LOW POWER : 5W

Memory channels 1 through 21 are useful for storing often-used frequencies.

Push the [MR] side of the [VFO/MR] SWITCH to select the MEMORY mode.

- The letter "M" appears below the small memory channel number on the right side of the display to indicate the MEMORY mode is selected.

Turn the TUNING CONTROL clockwise or counterclockwise to select the desired memory channel.

- The selected memory channel number and contents of the memory appear on the display.

Ⓑ USING THE DOWN/UP SWITCH

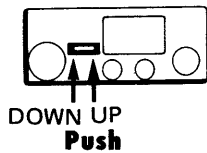

Push the [DOWN] or [UP] side of the front panel [DOWN/UP] SWITCH to individually step through the memory channels.

- Each memory channel number and contents of its memory appear on the display as the IC-38A steps through the memory channels.

Ⓒ USING THE MICROPHONE

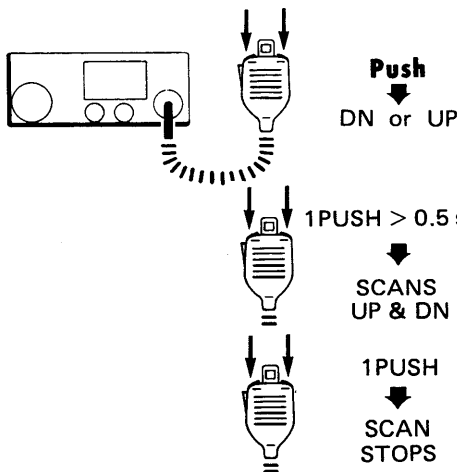

Push the [UP] SWITCH or [DN] SWITCH on the microphone to step through the memory channels.

NOTE: The microphone SCAN SWITCH must be ON when using the [UP] or [DN] SWITCH on the microphone.

- Each memory channel number and contents of its memory appear on the display.
- This method is useful to monitor all channels since holding these switches down for longer than about 1/2 second causes the memory scan function to begin. See page 17 MEMORY CHANNEL SCANNING for more information.

(2) MEMORY PROGRAMMING

Example: Store 223.100MHz in memory channel 21.

Use the following procedure to store operating frequencies plus duplex and memory skip information in memory channels. The duplex and memory skip functions are described in later sections.

- 1) Select memory channel 21.

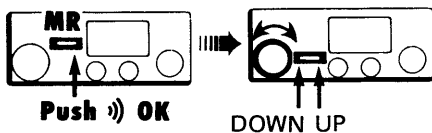

- 1) Select the memory channel to be programmed by using the MEMORY READING procedure as described on page 14.

- 2) Select VFO mode.

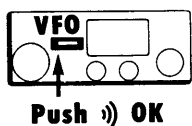

- 2) Push the [VFO] side of the [VFO/MR] SWITCH.

- 3) Select 223.100MHz.

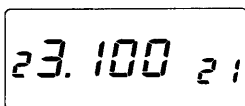

- 3) While in the VFO mode, select the information you wish to write into a memory channel:
 - a) Operating frequency (Page 13)
 - b) Duplex and subaudible tone programming (Pages 18 ~ 21)
 - c) Memory skip programming (Page 18)

- 4) Push [WRITE] SWITCH.

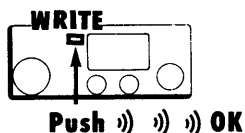

- 4) Push and hold the [WRITE] SWITCH for about 1/2 second.

- The 3 short tones indicate that the information selected in step 3) is now stored in the memory channel. Do not release the [WRITE] SWITCH until the 3 tones are heard.
- Push the [MR] side of the [VFO/MR] SWITCH to confirm the memory channel has the correct information stored.

(3) MEMORY CHANNEL TO VFO TRANSFERS

Example: Transfer the contents of memory channel 15 to the VFO.

- 1) Select memory channel 15.

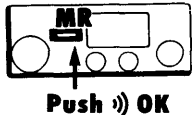

- 2) Push and hold [WRITE] SWITCH.

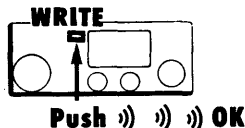

At times it may be desirable to transfer the contents of a memory channel to the VFO. Perform the following steps:

- 1) Select the memory channel containing the information to be transferred.

See page 14 for information on selecting memory channels.

- 2) Push and hold the [WRITE] SWITCH for about 1/2 second.

- The 3 short tones indicate that the information contained in the memory channel has been transferred to the VFO. Do not release the [WRITE] SWITCH until the 3 tones are heard.
- After the transfer is completed, the IC-38A changes to the VFO mode and the MEMORY mode "M" disappears from the display.
- This transfer function does not affect the contents of the memory channel.

4 - 3 SCAN FUNCTIONS



(1) FREQUENCY SCANNING

- 1) Select VFO mode.

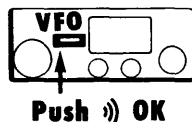

Both frequency and memory scanning on the IC-38A are controlled from the microphone. Before attempting to use either scan function, set the [SQL/CHK] CONTROL as below:

- [SQL/CHK] CONTROL : Speaker noise quieted
- [T/R] INDICATOR : OFF

When using the frequency scan, the entire frequency range is automatically searched by the IC-38A using the programmed size of frequency steps.

The receiver only stops on frequencies where a signal is present.

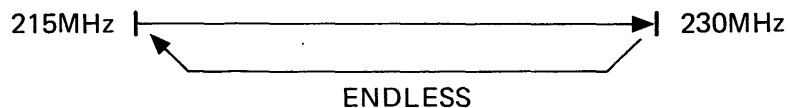

- 1) Push the [VFO] side of the [VFO/MR] SWITCH.

- 2) Push [UP] or [DN] SWITCH to start scan.

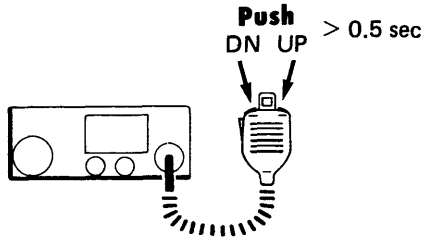

NOTE: The microphone SCAN SWITCH must be ON.

- 3) Push [UP] SWITCH or [DN] SWITCH to cancel scan.

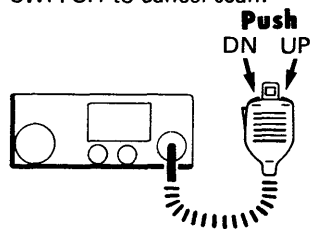

(2) MEMORY CHANNEL SCANNING

- 1) Select MEMORY mode.

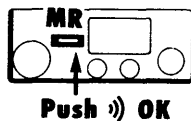

- 2) Push [UP] or [DN] SWITCH to start scan.

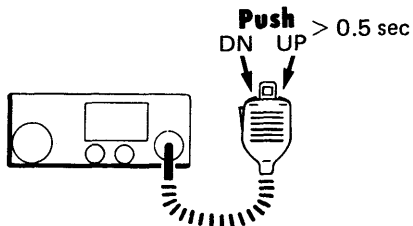

- 3) Push [UP] or [DN] SWITCH to cancel the scan.

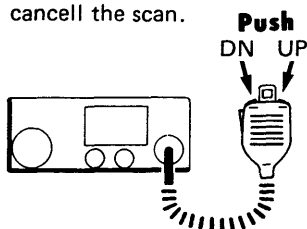

- 2) Push and hold the [UP] SWITCH or [DN] SWITCH on the microphone for about 1/2 second.

- The decimal point on the display begins to blink indicating the scan has started.
- The receiver scans in ascending order if the [UP] SWITCH is pushed, or in descending order if the [DN] SWITCH is pushed. The frequency on the display changes to indicate each frequency checked as the scan progresses.
- When a signal opens the receiver squelch circuit (i.e. the green [T/R] INDICATOR lights), the scan stops and the receiver monitors the signal. The scan begins again about 3 seconds after the frequency is clear of the signal, or about 15 seconds after the scan stops.

- 3) Push either the [UP] SWITCH or [DN] SWITCH on the microphone in order to cancel the scan function.

The memory channel scan is similar to the frequency scan except that all of the memory channels are checked repeatedly for signals.

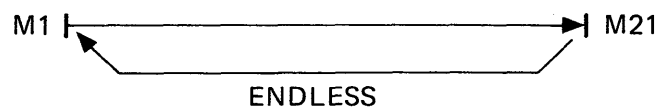

- 1) Push the [MR] side of the [VFO/MR] SWITCH.

- 2) Follow step 2) in FREQUENCY SCANNING above.

- 3) Push either the [UP] SWITCH or [DN] SWITCH on the microphone in order to cancel the scan function.

(3) MEMORY SKIP FUNCTION

- 1) Select MEMORY mode.

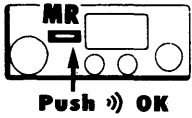

- 2) Select channel to be skipped.

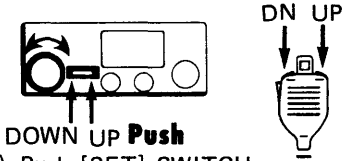

- 3) Push [SET] SWITCH.

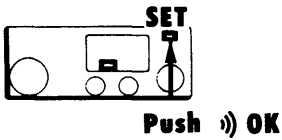

- 4) Push [SET] SWITCH to cancel skip function.

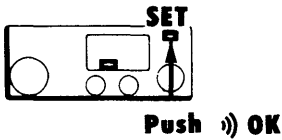

4 - 4 DUPLEX MODE

(1) DUPLEX PROGRAMMING

Example: Program the following frequencies:

Receive : 221.500MHz
 Transmit: 223.100MHz

- 1) Select VFO mode.

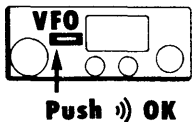

- 2) Select the receive frequency.



Memory channels which are not required to be scanned may be eliminated from the memory channel scan by the following procedure:

- 1) Push the [MR] side of the [VFO/MR] SWITCH.

- 2) Select the channel which is not required in the memory channel scan.

- 3) Push the [SET] SWITCH.

- The "SKIP" INDICATOR appears on the display.
- The selected channel will now be skipped when using the memory channel scan.

- 4) Push the [SET] SWITCH again to cancel the skip function on this channels.

The duplex mode allows operation with a transmit frequency which is different from the receive frequency. This is necessary when operating through repeaters. When the receive and transmit frequencies are identical, this is referred to as the simplex mode.

NOTE: Transmit offset refers to the frequency difference between the receive and transmit frequencies when using the duplex mode.

- 1) Push the [VFO] side of the [VFO/MR] SWITCH.

- 2) Turn the TUNING CONTROL to select the receive frequency. See page 13 SELECTING A FREQUENCY for more information.

3) Push the [SET] SWITCH.



Push)) OK

4) Select 1.6MHz transmit offset.



DOWN UP
Push

5) Select VFO mode.



VFO
Push)) OK

6) Push [DUP] SWITCH to select the duplex mode.

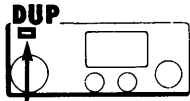

DUP
Push)) OK

7) Push [SQL/CHK] CONTROL to check transmit frequency.

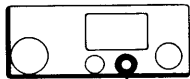

Push
SQL/CHK

3) Push the [SET] SWITCH repeatedly until the "OW" INDICATOR appears flashing on the display.

- The current transmit offset and the offset programming symbol ("F" or "P") also appear.

DISPLAYED SYMBOL	SYMBOL MEANING	OFFSET VALUE
"F"	FIXED Offset	1.6MHz
"P"	PROGRAMMABLE	0 ~ 7.99MHz

4) Push the front panel [DOWN/UP] SWITCH to select one of the two methods for programming the transmit offset.

- The usual position is "F" since most repeaters operate with a 1.6MHz split between the receive and transmit frequencies.
- If the "P" position is selected, use the TUNING CONTROL to choose your required transmit offset value.

5) Push the [VFO] side of the [VFO/MR] SWITCH.

6) Push the [DUP] SWITCH to select either the DUPLEX (-) or DUPLEX (+) condition.

- DUP (-): The transmit frequency is lower than the receive frequency by the offset amount.
- DUP (+): The transmit frequency is higher than the receive frequency by the offset amount.
- Neither DUP (-) nor DUP (+) displayed:
The IC-38A is in the simplex mode with both receive and transmit frequencies equal.

7) Push the [SQL/CHK] CONTROL in order to monitor the transmit frequency when operating with the duplex mode.

- This allows checking of the signal strength of your contacted station directly without going through a repeater. If the signal is received strongly enough directly, both stations should move to a simplex frequency.

(2) PROGRAMMING THE SUBAUDIBLE TONE FREQUENCY

- 1) Select VFO mode.



Push \Rightarrow OK

- 2) Push [SET] SWITCH.

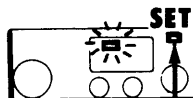

Push \Rightarrow OK

- 3) Push [DOWN/UP] SWITCH.

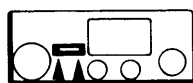

Push

- 4) Turn TUNING CONTROL.

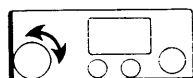

- 5) Select the VFO mode.



Push \Rightarrow OK

- 6) Select the duplex mode.

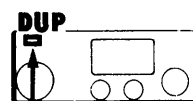

Push \Rightarrow OK

- 7) Activate tone encoder.



Push \Rightarrow OK

The supplied tone encoder allows access to repeaters which require a subaudible tone superimposed on the transmit signal in order to open the squelch circuit of the receiver at the repeater station.

- 1) Push the [VFO] side of the [VFO/MR] SWITCH.

- 2) Push the [SET] switch repeatedly until the "TONE" INDICATOR appears flashing on the display.

3. Push the front panel [DOWN/UP] SWITCH to select one of the tone memories.

NOTE: In this mode, the IC-38A can store a total of three tone numbers in the three tone memories. The tone memories are numbered "1", "2" and "3" and appear on the right side of the display.

- 4) Use the TUNING CONTROL to select a subaudible tone number.

- Refer to the SUBAUDIBLE TONE ENCODER FREQUENCY CHART on page 21 to determine the number to select for your required tone frequency.

- 5) Push the [VFO] side of the [VFO/MR] SWITCH.

- 6) Push the [DUP] SWITCH to select DUPLEX (-) or DUPLEX (+).

- 7) Push the [TONE] SWITCH to turn the subaudible tone encoder ON or OFF.

- The "TONE" INDICATOR appears when the tone encoder is activated.
- The subaudible tone will be transmitted each time a transmission is made.
- The tone encoder does not function when the simplex mode is used.

●SUBAUDIBLE TONE ENCODER FREQUENCY CHART

TONE NUMBER	FREQUENCY (Hz)	TONE NUMBER	FREQUENCY (Hz)	TONE NUMBER	FREQUENCY (Hz)
01	67.0	15	110.9	29	179.9
02	71.9	16	114.8	30	186.2
03	74.4	17	118.8	31	192.8
04	77.0	18	123.0	32	203.5
05	79.7	19	125.3	33	210.7
06	82.5	20	131.8	34	218.1
07	85.4	21	136.5	35	225.7
08	88.5	22	141.3	36	233.6
09	91.5	23	146.2	37	241.8
10	94.8	24	151.4	38	250.3
11	97.4	25	156.7	39	-----
12	100.0	26	162.2	40	-----
13	103.5	27	167.9	41	-----
14	107.2	28	173.8	42	-----

4 - 5 MICROPHONE

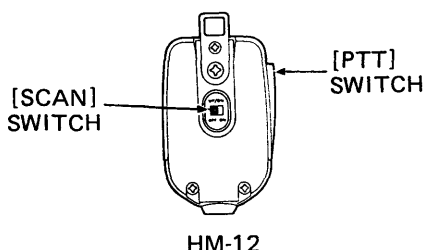

[PTT] SWITCH:

Push this switch to turn the transmitter ON and OFF.

[UP] SWITCH and [DN] (down) SWITCH (on the top):

Push either of these switches in the VFO mode to change the operating frequency in the direction indicated on the switch by one step. Hold either switch down to start the frequency scan.

In the MEMORY mode, the switches change the selected memory channels one channel at a time. Hold either switch down to start the memory channel scan.

[SCAN] SWITCH:

- OFF: The [UP] SWITCH and [DN] SWITCH on the microphone are disabled to eliminate the chance of accidental frequency or memory channel changes.
- ON: The [SCAN] SWITCH must be ON for the [UP] SWITCH and [DN] SWITCH to function as described above.

NOTE: When scanning, the [SCAN] SWITCH must remain ON at all times.

4 - 6 BACKUP BATTERY

The IC-38A contains a lithium battery as a backup for the internal microcomputer memory in the transceiver for times when the external power source is removed or interrupted. The lithium battery is a reliable backup device which has been proven to last for more than five years under actual operating conditions.

NOTE: Battery replacement should be done by your nearest authorized ICOM dealer or ICOM service center.

See page 23 for the battery location.

4 - 7 RESETTING INTERNAL MICROCOMPUTER (CPU)

Occasionally, the LCD READOUT may display erroneous information either during operation or when first applying power. This may, for example, be due to an external cause such as static electricity.

When this sort of problem is encountered, turn OFF the power to the IC-38A wait a few seconds, and turn the power ON again. If the problem persists, perform the following procedure:

- 1) Turn ON the power to the IC-38A.
- 2) Locate the RESET HOLE in the bottom cover of the transceiver.
- 3) Insert a non-metallic probe through the hole and push the RESET SWITCH.
- 4) The microcomputer in the IC-38A is now reset and the following parameters are automatically set as shown in the chart below.

NOTE: After resetting the CPU, all memory channels must be re-programmed.
--

● INITIAL INDICATION

FREQUENCY	TUNING STEPS	OPERATING MODE	TRANSMIT OFFSET
220.000MHz	20kHz	VFO/SIMPLEX	1.6MHz

SECTION 5 INSIDE VIEWS

5 - 1 TOP VIEW (MAIN UNIT)

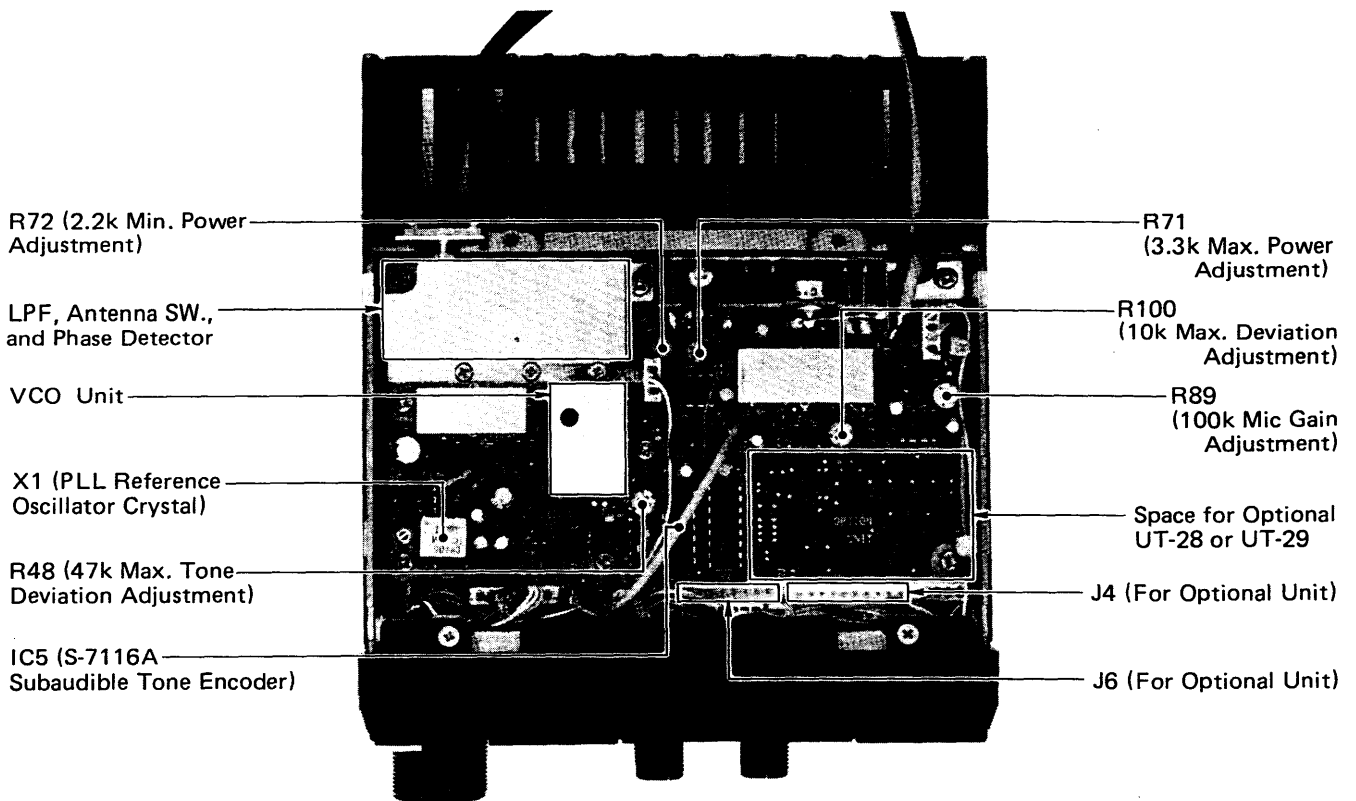

5 - 2 BOTTOM VIEW (RX UNIT)

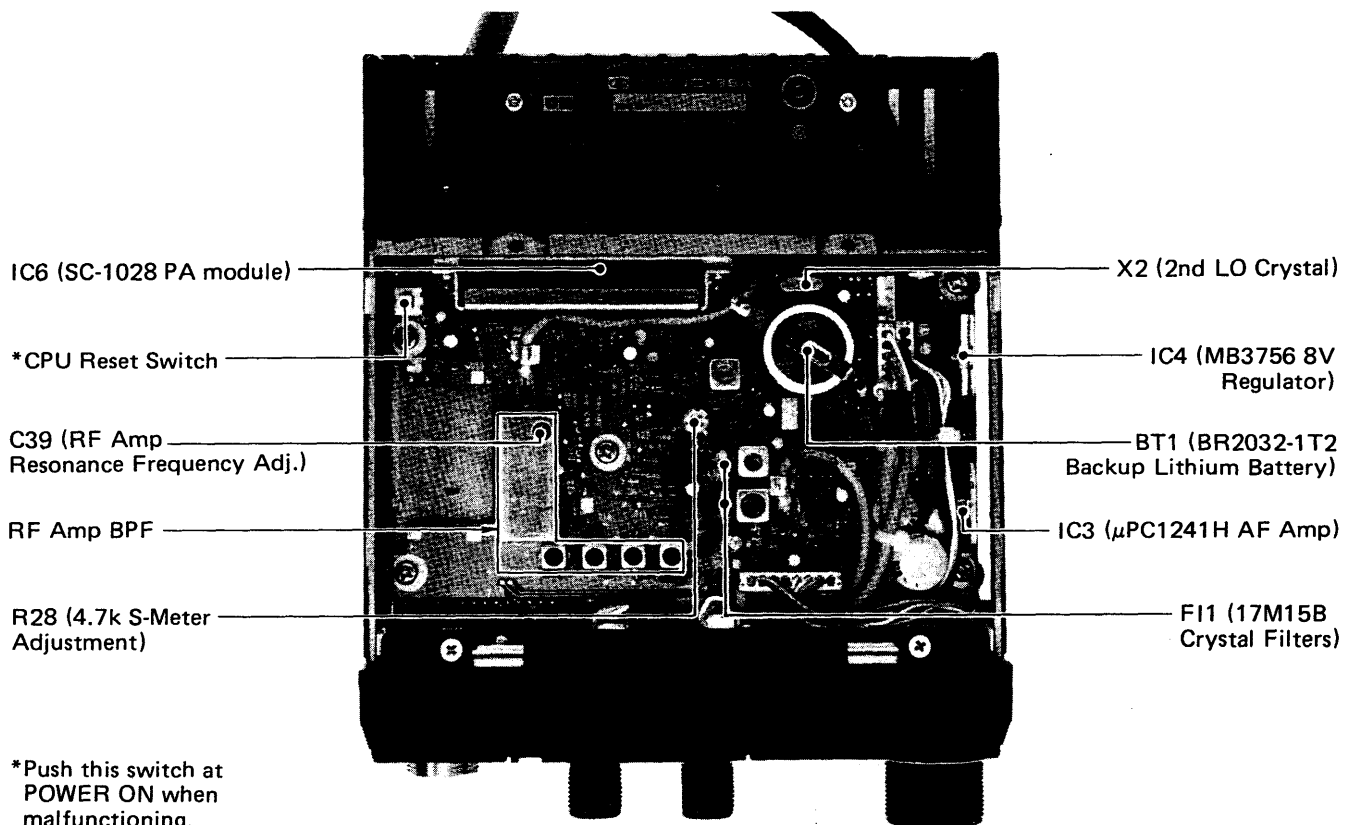

SECTION 6 MAINTENANCE

(1) OPERATING ENVIRONMENT



The IC-38A is a sensitive electronic device which should not be abused. Avoid using the IC-38A in excessively hot, humid or dusty environments. Do not subject the transceiver to strong vibrations or install it where water damage could result.

(2) ADJUSTMENTS

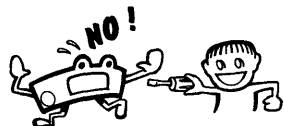

No internal adjustment of the transceiver is required since all variable components have been set correctly by the factory. Misadjusting certain components may damage the transceiver.

(3) MALFUNCTIONS



A variety of apparent problems can be solved by simply resetting the internal microcomputer in the IC-38A. See page 22 **RESETTING INTERNAL MICROCOMPUTER (CPU)** for more information.

(4) CLEANING

The IC-38A will eventually require cleaning after sitting in your ham shack for a period of time. Remove the three knobs from the front panel and use a soft cloth with a mild, soapy solution. Do not use strong chemicals or cleaning solvents. Wipe dry before replacing the knobs on the panel.

(5) FUSES

Locate the cause for a blown fuse before replacing it and attempting to operate the IC-38A again. The IC-38A uses 15 ampere fuses in the DC power cable.

●CHANGING A FUSE

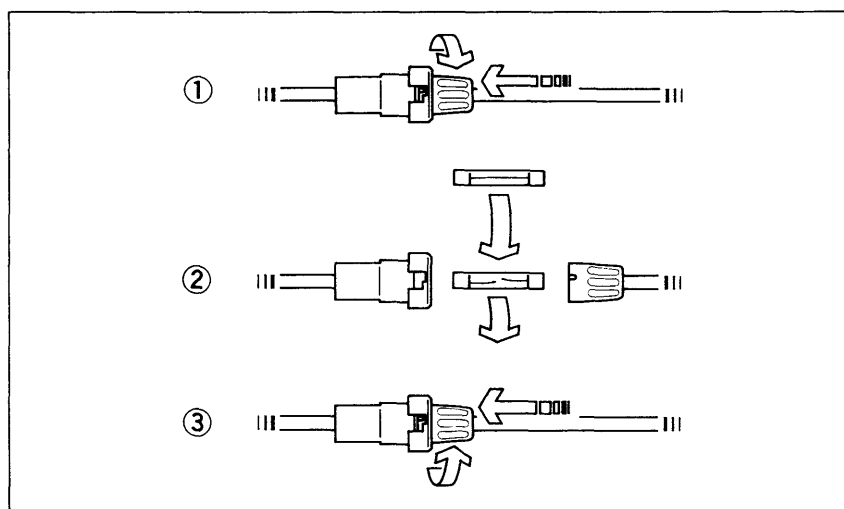

■ TROUBLESHOOTING

The following chart is designed to help you correct problems which are not equipment malfunctions. If you are not able to locate the cause of the problem or to solve it through the use of this chart, contact your nearest ICOM service center or dealer.

PROBLEM	POSSIBLE CAUSE	SOLUTION
1. Power does not come on when the [VOL/PWR] CONTROL is pushed ON.	<ul style="list-style-type: none"> • Power cable is improperly connected. • Power connector is making poor contact. • Polarity of the power connection is wrong. • Blown fuse. 	<ul style="list-style-type: none"> • Carefully reconnect power cable. • Check the connector pins. • Disconnect the power cable, replace the blown fuse, then reconnect the power cable observing proper polarity. • Check for the cause, then replace the fuse.
2. No sound comes from the speaker.	<ul style="list-style-type: none"> • Volume setting is too low. • [SQL/CHK] CONTROL is set incorrectly. • External speaker is connected. 	<ul style="list-style-type: none"> • Set volume to an appropriate level. • Adjust squelch so the noise from the speaker is just quieted while receiving no signal. • Check that the external speaker plug is inserted properly, and that the external speaker cable is not cut.
3. Sensitivity is low and only strong signals are audible.	<ul style="list-style-type: none"> • Antenna feedline is cut or shortcircuited. 	<ul style="list-style-type: none"> • Check, and if necessary, replace the feedline.
4. No or low RF output.	<ul style="list-style-type: none"> • The LOW position is selected with the [HI/LO] SWITCH. • [PTT] SWITCH on the microphone is not operating due to poor connection of the MIC CONNECTOR. 	<ul style="list-style-type: none"> • Push the [HI/LO] SWITCH to select the HIGH output power position. • Check the connector pins on the MIC CONNECTOR.
5. No modulation of the transmitter.	<ul style="list-style-type: none"> • Poor connection of the MIC CONNECTOR. 	<ul style="list-style-type: none"> • Check the connector pins on the MIC CONNECTOR.
6. Frequency does not change when the TUNING CONTROL is turned.	<ul style="list-style-type: none"> • MEMORY mode is selected. 	<ul style="list-style-type: none"> • Push the [VFO] side of the [VFO/MR] SWITCH.
7. An abnormal, out-of-band frequency is displayed on the LCD READOUT.	<ul style="list-style-type: none"> • CPU malfunction. • Lithium backup battery is exhausted. 	<ul style="list-style-type: none"> • Reset the CPU (microcomputer). See page 22. • Take your IC-38A to an authorized ICOM dealer or service center.
8. Scan functions do not stop even when signals are received.	<ul style="list-style-type: none"> • [SQL/CHK] CONTROL is set incorrectly. 	<ul style="list-style-type: none"> • Adjust squelch so the noise from the speaker is just quieted while receiving no signal.
9. Memory channel frequencies change after resetting the CPU.	<ul style="list-style-type: none"> • All memories are initialized after the CPU is reset. 	<ul style="list-style-type: none"> • Re-program the memory channels after the CPU is reset.

SECTION 7 BLOCK DIAGRAM

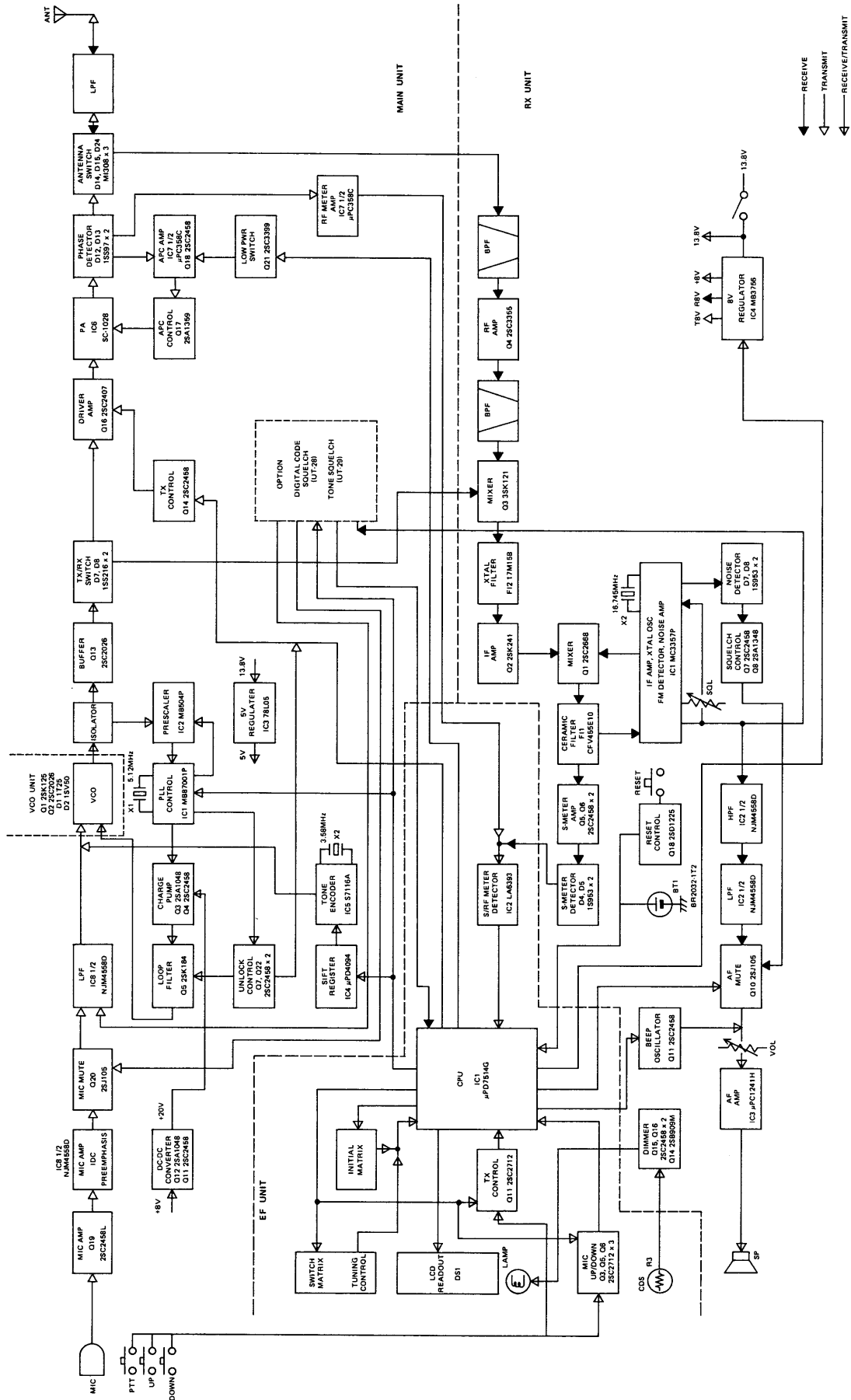

SECTION 8 OPTIONS

PS-45 AC POWER SUPPLY
(13.8V DC, 8A maximum)

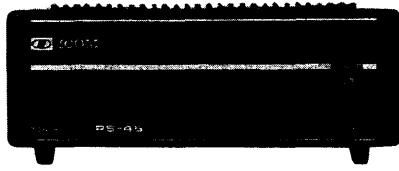

The OPC-102 interface cable to connect the PS-45 to the IC-38A must be purchased separately.

SP-10 MOBILE SPEAKER

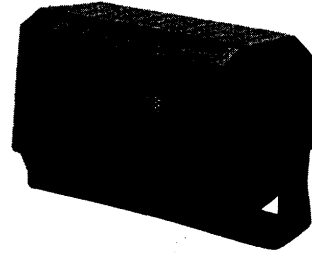

HS-15 FLEXIBLE MOBILE MICROPHONE

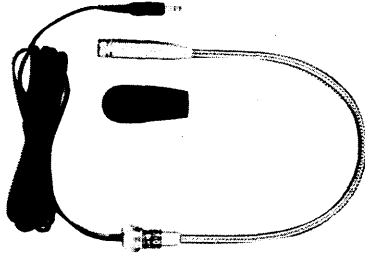

HS-15SB SWITCHBOX FOR HS-15

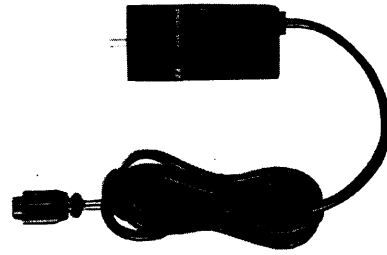

**SM-10 COMPRESSOR/
GRAPHIC EQUALIZER
MICROPHONE**

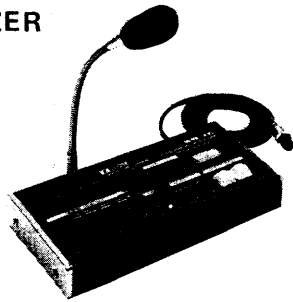

SM-8 DESK MICROPHONE



UT-28 DIGITAL CODE SQUELCH UNIT

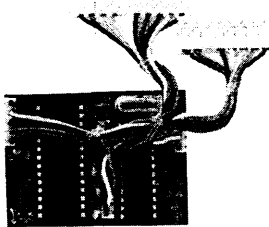

UT-29 TONE SQUELCH UNIT



SP-7	EXTERNAL BASE SPEAKER
SP-8	EXTERNAL MOBILE SPEAKER
IC-HM14	DTMF MICROPHONE
IC-HM16	SPEAKER-MICROPHONE



ICOM INCORPORATED

1-6-19, KAMI KURATSUKURI, HIRANO-KU,
OSAKA 547, JAPAN

A-0819
Printed in Japan