



BASIC MANUAL

DUAL BAND TRANSCEIVER

ID-4100A ID-4100E



This device complies with Part 15 of the FCC rules. Operation is subject to the following two conditions: (1) This device may not cause harmful interference, and (2) this device must accept any interference received, including interference that may cause undesired operation.

WARNING: MODIFICATION OF THIS DEVICE TO RECEIVE CELLULAR RADIOTELEPHONE SERVICE SIGNALS IS PROHIBITED UNDER FCC RULES AND FEDERAL LAW.

Icom Inc.

Thank you for choosing this Icom product. This product is designed and built with Icom's state of the art technology and craftsmanship. With proper care, this product should provide you with years of trouble-free operation.

This product combines traditional analog technologies with the new digital technology, Digital Smart Technologies for Amateur Radio (D-STAR), for a balanced package.

IMPORTANT

READ ALL INSTRUCTIONS carefully and completely before using the transceiver.

SAVE THIS INSTRUCTION MANUAL— This instruction manual contains basic operating instructions for the ID-4100A/ID-4100E.

For Advanced features and instructions, see the Advanced manual on the Icom website for details.

About E-marking:

Detailed installation notes for Icom mobile transceivers to be fitted into vehicles are available.

Please contact your Icom dealer or distributor.

EXPLICIT DEFINITIONS

WORD	DEFINITION
⚠ DANGER!	Personal death, serious injury or an explosion may occur.
⚠ WARNING!	Personal injury, fire hazard or electric shock may occur.
CAUTION	Equipment damage may occur.
NOTE	Recommended for optimum use. No risk of personal injury, fire or electric shock.

SUPPLIED ACCESSORIES

The following accessories are supplied with the transceiver.

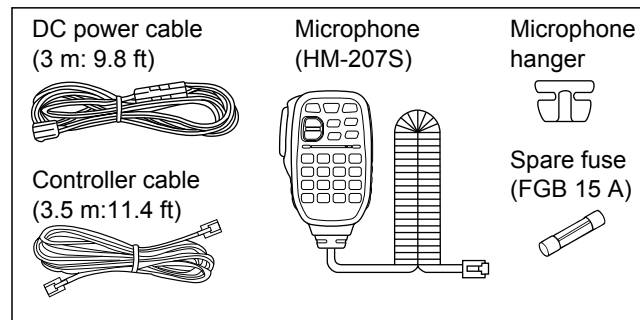

ABOUT THE CONSTRUCTION OF THE MANUAL

(As of May 2017)

You can see the following manuals to use and understand this transceiver.

Basic manual (This manual)

Instructions for the basic operations, precautions, installations, and connections.

D-STAR Guide (Comes with the transceiver)

Instructions for registering your call sign to a gateway repeater and the basic operations of D-STAR.

About the DV Gateway function (PDF type)

Instructions for the system requirements or operations to use the DV Gateway function.

① “About the DV Gateway function” can be downloaded from the Icom website.

Advanced manual (PDF type)

Instructions for the advanced operations, as shown below.

- Memory operation <Advanced>*
- Scan operation <Advanced>*
- Priority watch operation
- D-STAR operation <Advanced>*
- GPS operation
- Using a microSD card
- Voice memory operation
- Repeater and duplex operations
- Menu screen <Advanced>*
- Other functions
- Options <Advanced>*
- Bluetooth® operation

① This manual can be downloaded from the Icom website.

*The basic instructions are described on this manual.

TIP:

- You can download each manual and guide from the Icom website, <http://www.icom.co.jp/world/>. Enter 'ID-4100' into the Search box in the site.
- If necessary, you can see a glossary of HAM radio terms that can be downloaded from the Icom website.
- To read the guide or manual, Adobe Acrobat Reader is required. If you have not installed it, please download the Adobe Acrobat Reader from Adobe Systems Incorporated's website.

OPTIONS

(As of May 2017)

Microphone/Speaker

HM-154	HAND MICROPHONE
HM-207S	HAND MICROPHONE (REMOTE-CONTROL)
HM-209	NOISE CANCELING MICROPHONE
HM-232	HAND MICROPHONE (SIMPLE)
OPC-440	MIC EXTENSION CABLE: 5 m (16.4 ft)*
OPC-647	MIC EXTENSION CABLE: 2.5 m (8.2 ft)*
SP-30	EXTERNAL SPEAKER: 2.8 m (9.1 ft)*
SP-35	EXTERNAL SPEAKER: 2 m (6.5 ft)*
SP-35L	EXTERNAL SPEAKER: 6 m (19.6 ft)*

*Approximate

Software

CS-4100	CLONING SOFTWARE
RS-MS1A	Android™ APPLICATION
RS-MS11	iOS™ APPLICATION
RS-MS3W	TERMINAL MODE/ACCESS POINT MODE SOFTWARE: For Windows
RS-MS3A	TERMINAL MODE/ACCESS POINT MODE APPLICATION: For Android™ devices
OPC-2350LU	DATA CABLE: USB type
OPC-478UC	CLONING CABLE: USB type

Bluetooth

UT-137	Bluetooth® UNIT
VS-3	Bluetooth® HEADSET

Others

MBA-8	CONTROLLER BRACKET
MBF-1	MOUNTING BASE: MBA-8 is required
MBF-4	MOBILE BRACKET
OPC-345	DC POWER CABLE
OPC-589	MIC ADAPTOR CABLE
OPC-1156	CONTROLLER EXTENSION CABLE: 3.5 m (11.4 ft)

Icom is not responsible for the destruction, damage to, or performance of any Icom or non-Icom equipment, if the malfunction is because of:

- Force majeure, including, but not limited to, fires, earthquakes, storms, floods, lightning, other natural disasters, disturbances, riots, war, or radioactive contamination.
- The use of Icom transceivers with any equipment that is not manufactured or approved by Icom.

TABLE OF CONTENTS BY TOPIC

Controller

Attaching/Installing	1, 2
Front panel	9
Display.....	11
Power key.....	19

Microphone

Connecting	3
HM-207S	16

Main unit

Connecting to a DC power supply	3
Installing in a vehicle	4
Installing an antenna	5
Front/Rear panel.....	14, 15

Bluetooth

Installing the UT-137.....	7
Details of the Bluetooth operation	AM* (sec. 12)

microSD card

Inserting/Removing.....	48, 50
Saving the setting data.....	AM* (sec. 6)

MENU screen/Quick Menu

Quick Menu window	20
MENU screen description.....	27
Menu item list	63
Details of the MENU screen	AM* (sec. 9)

Memory channel

Memory channel operation.....	41
Details of the Memory channel operation	AM* (sec. 1)

Scan

Scan operation	43
Setting and clearing a Skip channel	46
Details of the Scan operation	AM* (sec. 2)

GPS

GPS operation	51
Checking your GPS position.....	51
Details of the GPS operation	AM* (sec. 5)

D-STAR

Basic operation.....	D-STAR Guide
Register your call sign at a gateway repeater ..	D-STAR Guide
Details of the D-STAR operation	AM* (sec. 4)

*“AM” indicates the Advanced manual.

PRECAUTIONS

⚠ **DANGER HIGH VOLTAGE! NEVER** touch the antenna connector during transmission. This may result in an electrical shock or burn.

⚠ **DANGER! NEVER** operate the transceiver near unshielded electrical blasting caps or in an explosive atmosphere.

⚠ **DANGER! NEVER** place the transceiver where air bag deployment may be obstructed during mobile operations.

⚠ **WARNING RF EXPOSURE!** This transceiver emits Radio Frequency (RF) energy. Extreme caution should be observed when operating this transceiver. If you have any questions regarding RF exposure and safety standards please refer to the Federal Communications Commission Office of Engineering and Technology's report on Evaluating Compliance with FCC Guidelines for Human Radio Frequency Electromagnetic Fields (OET Bulletin 65).

⚠ **WARNING! NEVER** operate the transceiver while driving a vehicle. Safe driving requires your full attention—anything less may result in an accident.

⚠ **WARNING! NEVER** operate the transceiver with an earphone or other audio accessories at high volume levels. Continuous high volume operation may cause a ringing in your ears. If you experience ringing, reduce the volume level or discontinue use.

⚠ **WARNING! NEVER** connect the transceiver to an AC outlet. This may pose a fire hazard or result in an electric shock.

⚠ **WARNING! NEVER** connect the transceiver to a power source of more than 16 V DC such as a 24 V DC battery. This could cause a fire or damage the transceiver.

⚠ **WARNING! NEVER** reverse the DC power cable polarity when connecting to a power source. This could damage the transceiver.

⚠ **WARNING! NEVER** operate the transceiver during a lightning storm. It may result in an electric shock, cause a fire or damage the transceiver. Always disconnect the power source and antenna before a storm.

⚠ **WARNING! NEVER** cut the DC power cable between the DC plug and fuse holder. If an incorrect connection is made after cutting, the transceiver may be damaged.

⚠ **WARNING! NEVER** let metal, wire or other objects touch any internal part or connectors on the rear panel of the transceiver. This may result in an electric shock or this could cause a fire or damage the transceiver.

⚠ **WARNING! NEVER** operate or touch the transceiver with wet hands. This may result in an electric shock or may damage the transceiver.

⚠ **WARNING! NEVER** operate the transceiver if it emits an abnormal odor, sound or smoke. Immediately turn OFF the transceiver power and remove the power cable. Contact your Icom dealer or distributor for advice.

⚠ **WARNING! NEVER** place the transceiver where normal operation of the vehicle may be hindered or where it could cause bodily injury.

CAUTION: DO NOT expose the transceiver to rain, snow or any liquids.

CAUTION: DO NOT change the internal settings of the transceiver. This may reduce transceiver performance and/or damage the transceiver.

CAUTION: DO NOT use harsh solvents such as Benzine or alcohol to clean the transceiver, as they will damage the transceiver's surfaces. If the transceiver becomes dusty or dirty, wipe it clean with a soft, dry cloth.

CAUTION: DO NOT place or leave the transceiver in areas with temperatures below -10°C ($+14^{\circ}\text{F}$) or above $+60^{\circ}\text{C}$ ($+140^{\circ}\text{F}$). Be aware that temperatures on a vehicle's dashboard can exceed $+80^{\circ}\text{C}$ ($+176^{\circ}\text{F}$) in direct sunlight, resulting in permanent damage to the transceiver if left there for long periods of time.

CAUTION: DO NOT start the vehicle engine when the transceiver's power is ON. Ignition voltage spikes can damage the transceiver.

CAUTION: DO NOT use non-Icom microphones. Other manufacturer's microphones have different pin assignments, and may damage the transceiver.

DO NOT push the PTT when not actually desiring to transmit.

DO NOT place the transceiver in excessively dusty environments or in direct sunlight.

DO NOT place the transceiver against walls or putting anything on top of the transceiver. This will obstruct heat dissipation.

DO NOT place the transceiver in an insecure place to avoid inadvertent use by unauthorized persons.

DO NOT place the transceiver where hot or cold air blows directly onto it, during mobile operation.

DO NOT operate the transceiver without running the vehicle's engine, during mobile operation. When the transceiver's power is ON and your vehicle's engine is OFF, the vehicle's battery will soon become exhausted.

NOTE: During maritime mobile operation, keep the transceiver and microphone as far away as possible from the magnetic navigation compass to prevent erroneous indications.

BE CAREFUL! The rear panel will become hot when continuously operating the transceiver for long periods of time.

IMPORTANT NOTES

◇ When using the GPS receiver

- GPS signals cannot pass through metal objects. When using the transceiver inside a vehicle, you may not receive GPS signals. We recommend you use it near a window. Please avoid the areas where:
 1. The driver's view will be blocked.
 2. The air bags could deploy.
 3. The unit becomes a driving obstacle.
- The Global Positioning System (GPS) is built and operated by the U.S. Department of Defense. The Department is responsible for accuracy and maintenance of the system. Any changes by the Department may affect the accuracy and function of the GPS system.
- When the GPS receiver is activated, please do not cover the remote controller with anything that will block the satellite signals.
- The GPS receiver may not work if used in the following locations:
 1. Tunnels or high-rise buildings
 2. Underground parking lots
 3. Under a bridge or viaduct
 4. In remote forested areas
 5. Under bad weather conditions (rainy or cloudy day)

◇ About GPS antenna

This transceiver's GPS antenna is located at the top back of the controller. If the controller's rear panel is covered with any object that interrupts the GPS signals from the satellites, the GPS receiver will not calculate its position. Therefore, when you are using the GPS feature, be sure the controller is positioned so the antenna has a clear view to receive signals from the satellites.

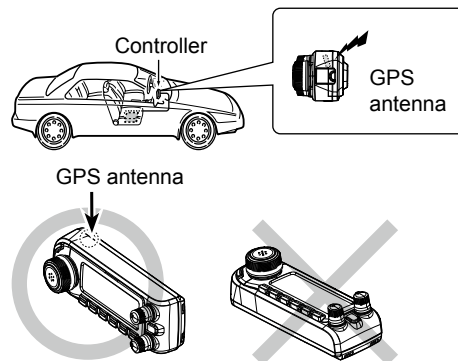

◇ Magnets

The optional MBA-8 CONTROLLER BRACKET uses strong magnets to attach the bracket to the controller's rear panel.

DANGER! NEVER place or attach the magnets on electronic medical equipment, such as an implanted cardiac pacemaker. It may affect the operation of the equipment. This could be life endangering.

BE CAREFUL not to pinch your finger when you attach the bracket to the controller's rear panel.

DO NOT put the controller near a clock, television set (CRT type), magnetic compass or any magnetic/IC cards, credit cards, and so on. The magnets may cause the products to malfunction or may erase the contents of magnetic storage devices.

Icom, Icom Inc. and Icom logo are registered trademarks of Icom Incorporated (Japan) in Japan, the United States, the United Kingdom, Germany, France, Spain, Russia, Australia, New Zealand, and/or other countries.

Adobe, Acrobat, and Reader are either registered trademarks or trademarks of Adobe Systems Incorporated in the United States and/or other countries.

The Bluetooth word mark and logos are registered trademarks owned by the Bluetooth SIG, Inc. and any use of such marks by Icom Inc. is under license.

Other trademarks and trade names are those of their respective owners.

Android and the Android logo are trademarks of Google, Inc.

iOS is a trademark or registered trademark of Cisco in the U.S. and other countries and is used under license.

All other products or brands are registered trademarks or trademarks of their respective holders.

DÉFINITIONS EXPLICITES

MOT	DÉFINITION
⚠ DANGER !	Risque d'accident mortel, de blessures corporelles graves ou d'explosion.
⚠ AVERTISSEMENT !	Risque de blessures corporelles, d'incendie ou de choc électrique.
ATTENTION	Risque de dégât matériel.
REMARQUE	Inconvénient seulement, en cas de non-respect. Absence de risque de blessures corporelles, d'incendie ou de choc électrique.

PRÉCAUTIONS

⚠ **DANGER TENSION À HAUTES RF ! NE JAMAIS** toucher l'antenne en cours d'émission ou de réglage d'accord. Au risque de provoquer un choc électrique ou des brûlures.

⚠ **DANGER ! NE JAMAIS** utiliser l'émetteur-récepteur à proximité de détonateurs électriques non blindés ou dans une atmosphère explosive.

⚠ **DANGER ! NE JAMAIS** placer l'émetteur-récepteur ni la face avant à des emplacements où ils pourraient entraver le déploiement des airbags, en utilisation mobile.

⚠ **AVERTISSEMENT RELATIF À L'EXPOSITION AUX FRÉQUENCES RADIO !** Cet appareil émet des ondes de fréquences radio (RF). Il doit être utilisé avec la plus grande prudence. Pour toutes questions concernant l'exposition aux fréquences radio et sur les règles de sécurité, veuillez consulter le rapport du Bureau Engineering and Technology de la Federal Communications Commission (FCC) sur l'évaluation de la conformité à la réglementation FCC sur l'exposition de l'homme aux champs électromagnétiques de fréquences radio (OET Bulletin 65).

⚠ **AVERTISSEMENT ! NE JAMAIS** utiliser l'émetteur-récepteur en conduisant un véhicule. La sécurité de la conduite requiert toute l'attention du conducteur — toute défaillance peut être à l'origine d'un accident.

⚠ **AVERTISSEMENT ! NE JAMAIS** utiliser l'émetteur-récepteur avec un casque ou tout autre accessoire audio à un niveau sonore élevé. L'utilisation continue à un niveau sonore élevé peut provoquer un bourdonnement dans vos oreilles. Si vous entendez un bourdonnement baissez le niveau du volume ou interrompez l'utilisation.

⚠ **AVERTISSEMENT ! NE JAMAIS** relier l'émetteur-récepteur à une prise CA. Cela pourrait provoquer un choc électrique ou un incendie.

⚠ **AVERTISSEMENT ! NE JAMAIS** connecter l'émetteur-récepteur à une source d'alimentation de plus de 16 V CC, tel qu'une batterie 24 V. Cela pourrait causer un incendie ou endommager l'émetteur-récepteur.

⚠ **AVERTISSEMENT ! NE JAMAIS** inverser la polarité lors de la connexion du câble d'alimentation CC à une source d'alimentation. Cela pourrait endommager l'émetteur-récepteur.

⚠ **AVERTISSEMENT ! NE JAMAIS** utiliser l'émetteur-récepteur durant un orage. Cela risquerait de provoquer un choc électrique, un incendie ou d'endommager l'émetteur-récepteur. Toujours débrancher la source d'alimentation et l'antenne avant une tempête.

⚠ **AVERTISSEMENT ! NE JAMAIS** couper le câble d'alimentation CC entre la prise CC à l'arrière de l'émetteur-récepteur et le porte fusible. L'émetteur-récepteur peut être endommagé par la suite en cas de connexion inappropriée.

⚠ **AVERTISSEMENT ! NE JAMAIS** permettre que du métal, du fil ou d'autres objets soit au contact de l'intérieur de l'émetteur-récepteur ou raccorder incorrectement les connecteurs sur le panneau arrière. Cela pourrait provoquer un choc électrique ou endommager l'appareil.

⚠ **AVERTISSEMENT ! NE JAMAIS** utiliser ou toucher l'émetteur-récepteur avec des mains mouillées. Cela pourrait provoquer un choc électrique ou endommager l'appareil.

⚠ **AVERTISSEMENT !** Coupez immédiatement le courant de l'émetteur-récepteur et enlevez le câble d'alimentation CC de l'émetteur-récepteur s'il émet une odeur, de la fumée ou un bruit anormal. Contactez votre revendeur ou distributeur Icom pour obtenir des conseils.

⚠ **AVERTISSEMENT ! NE JAMAIS** placer jamais l'émetteur-récepteur à un endroit pouvant gêner le fonctionnement normal du navire, ou à un endroit où il pourrait causer des blessures corporelles.

ATTENTION : NE PAS exposer l'émetteur-récepteur à la pluie, à la neige ou à tout autre liquide.

ATTENTION : NE PAS changer les réglages internes de l'émetteur-récepteur. Cela pourrait réduire les performances de l'émetteur-récepteur ou l'endommager.

PRÉCAUTIONS (Suite)

ATTENTION : NE PAS utiliser de dissolvants agressifs tels que du Benzène ou de l'alcool lors du nettoyage, car ils endommageraient les surfaces de l'émetteur-récepteur. Si l'émetteur-récepteur est poussiéreux ou sale, nettoyez-le avec un tissu doux et sec.

ATTENTION : NE PAS utiliser ou placer l'émetteur-récepteur dans des zones soumises à des températures inférieures à -10°C ($+14^{\circ}\text{F}$) ou supérieures à $+60^{\circ}\text{C}$ ($+140^{\circ}\text{F}$). Noter que la température au niveau de la plage arrière ou du tableau de bord d'un véhicule peut dépasser $+80^{\circ}\text{C}$ ($+176^{\circ}\text{F}$), ce qui peut endommager irrémédiablement la face avant de l'appareil en cas d'exposition prolongée.

ATTENTION : NE PAS Vérifier que l'appareil est éteint avant d'actionner le démarreur du véhicule. Dans le cas contraire, les pics de tension d'allumage du moteur risquent d'endommager l'émetteur-récepteur.

ATTENTION : Utiliser exclusivement un microphone Icom (fourni d'origine ou en option). La répartition des broches des microphones des autres fabricants est différente et leur connexion à l'ID-4100A/E peut endommager l'émetteur-récepteur.

NE PAS appuyer sur la touche PTT sans intention réelle d'émettre.

NE PAS placer l'émetteur-récepteur dans un environnement excessivement poussiéreux ou en plein soleil.

NE PAS placer l'émetteur-récepteur contre un mur ou poser des objets dessus. Cela risque de gêner la dispersion de la chaleur.

NE PAS placer l'émetteur-récepteur dans un endroit peu sûr pour éviter que des personnes non autorisées ne l'utilisent.

NE PAS placer l'émetteur-récepteur ni la face avant à des emplacements où ils pourraient être directement exposés à un flux d'air froid ou d'air chaud, en utilisation mobile.

NE PAS utiliser un émetteur-récepteur embarqué avec le moteur du véhicule arrêté, en utilisation mobile. Toute utilisation de l'émetteur-récepteur moteur arrêté a pour conséquence de vider rapidement la batterie du véhicule.

REMARQUE : En utilisation maritime mobile, éloignez le plus possible l'émetteur-récepteur et le microphone du compas de navigation magnétique afin d'éviter d'en altérer le fonctionnement.

MISE EN GARDE : Le panneau arrière de l'émetteur-récepteur chauffe en cas d'utilisation continue sur une longue durée.

MISE EN GARDE: Tout changement ou modification, non expressément approuvé par Icom Inc., peut annuler l'autorisation de l'utilisateur à utiliser cet appareil conformément à la réglementation FCC.

INFORMATION FCC

Cet équipement a été testé et reconnu conforme aux limites fixées pour un appareil numérique de classe B, conformément au point 15 de la réglementation FCC. Ces limites ont été fixées afin d'assurer une protection raisonnable contre les interférences nocives dans une installation résidentielle.

Cet équipement génère, utilise et peut émettre un rayonnement de fréquence radio. S'il n'a pas été installé conformément aux instructions, il peut par ailleurs créer des interférences perturbant les communications radio. Toutefois, il n'y a aucune garantie que les interférences ne se produiront pas dans une installation particulière.

Si cet équipement crée des interférences perturbant la réception de la radio ou de la télévision, comme cela peut être déterminé en éteignant et en allumant l'équipement, l'utilisateur est invité à essayer de corriger l'interférence en prenant une ou plusieurs des mesures ci-après :

- Réorienter ou changer de place l'antenne de réception.
- Éloigner l'équipement et le récepteur.
- Connecter l'équipement sur une prise sur un autre circuit que celui sur lequel le récepteur est connecté.
- Faire appel au revendeur ou à un technicien radio/TV expérimenté.

MISE AU REBUT



Le pictogramme poubelle barrée sur notre produit, notre documentation ou nos emballages vous rappelle qu'au sein de l'Union européenne, tous les produits électriques et électroniques, batteries et accumulateurs (batteries rechargeables) doivent être mise au rebut dans les centres de collecte indiqués à la fin de leur période de vie. Vous ne devez pas mettre au rebut ces produits avec les déchets municipaux non triés. Ils doivent être mis au rebut dans le respect de la réglementation en vigueur dans votre secteur.

Icom n'est pas responsable de la destruction ou des dommages sur l'émetteur-récepteur Icom, si le dysfonctionnement est causé par :

- Force majeure, sans toutefois s'y limiter, les incendies, tremblements de terre, tempêtes, inondations, la foudre, ou autres catastrophes naturelles, perturbations, émeutes, guerre, ou contamination radioactive.
- L'utilisation de l'émetteur-récepteur Icom avec tout équipement non fabriqué ou approuvé par Icom.

TABLE OF CONTENTS

IMPORTANT	i
EXPLICIT DEFINITIONS.....	i
SUPPLIED ACCESSORIES.....	i
ABOUT THE CONSTRUCTION OF THE MANUAL.....	ii
OPTIONS	iii
TABLE OF CONTENTS BY TOPIC.....	iv
PRECAUTIONS.....	v
IMPORTANT NOTES	vii
DÉFINITIONS EXPLICITES.....	ix
PRÉCAUTIONS.....	x
INFORMATION FCC	xii
MISE AU REBUT.....	xii

1 INSTALLATION AND CONNECTIONS..... 1–8

■ Attaching the controller	1
■ Installing the controller.....	2
■ Connecting a microphone.....	3
■ Connecting to a DC power supply	3
■ Installing in a vehicle.....	4
■ Installing an antenna.....	5
■ Connecting to a battery.....	6
■ Installing the UT-137.....	7
■ Electromagnetic Interference.....	8

2 PANEL DESCRIPTION..... 9–18

■ Controller — Front panel	9
■ Controller — Display.....	11
■ Main unit — Front panel	14
■ Main unit — Rear panel.....	15
■ Microphone (HM-207S)	16

3 BASIC OPERATION..... 19–26

■ Turning ON the transceiver.....	19
■ Monitor function	19
■ Setting audio volume and squelch level	19
■ Quick Menu window.....	20
■ Selecting the Mode	21
■ Selecting the operating band	22
■ Selecting the operating mode	22
■ Setting a frequency.....	23
■ Lock function.....	24
■ DR function	24
■ Speech function	25
■ Home Channel function	25
■ Transmitting	26

4 MENU SCREEN..... 27–40

■ MENU screen description	27
■ Selecting a Menu item	27
■ Menu items and their details.....	28

5 MEMORY OPERATION	41–42	10 SPECIFICATIONS	57–58
■ Entering Memory channels	41	11 INFORMATION	59–60
■ Checking the Memory contents	41	■ About CE and DOC	59
■ Selecting a Memory channel	42	■ Disposal	59
6 SCAN OPERATION	43–46	■ FCC information.....	60
■ VFO mode scan.....	43	12 INDEX	61–62
■ Memory scan	45	13 MENU ITEM LIST	63–64
■ Setting and clearing a Skip channel	46		
7 RECORDING A QSO ONTO A microSD CARD	47–50		
■ About the microSD card.....	47		
■ Inserting the microSD card	48		
■ Removing the microSD card.....	49		
■ Recording a QSO audio.....	50		
■ Playing recorded audio	50		
8 GPS OPERATION	51–52		
■ GPS operation	51		
■ Checking your GPS position.....	51		
9 MAINTENANCE	53–56		
■ Resetting.....	53		
■ Fuse replacement.....	54		
■ Power protect function	54		
■ Troubleshooting	55		

■ Attaching the controller

◇ When attaching to the main unit

Attaching:

Slide the controller in the direction of the arrow until the controller is locked and makes a 'click' sound.

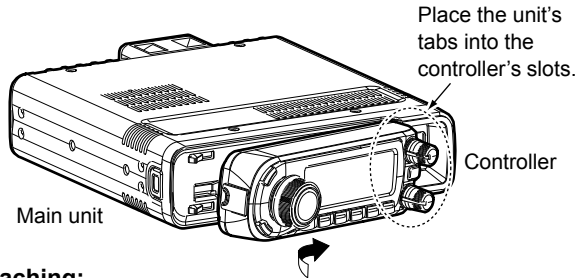

Detaching:

1. Push the release button on the main unit. (1)
2. Slide the controller to the left (2), then pull it out. (3)

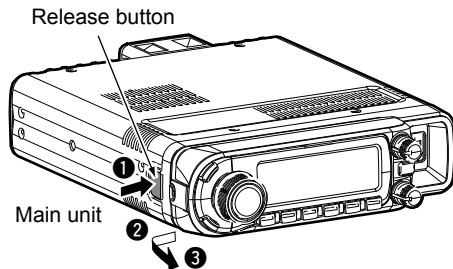

◇ When connecting to the main unit

Connect the controller to the main unit with the supplied control cable.

① The following longer cables are usable, depending on the installation location.

- OPC-440 MIC EXTENSION CABLE: 5 m (16.4 ft)*
- OPC-647 MIC EXTENSION CABLE: 2.5 m (8.2 ft)*
- OPC-1156 CONTROLLER EXTENSION CABLE: 3.5 m (11.4 ft)*
- SP-30 EXTERNAL SPEAKER: 2.8 m (9.1 ft)*
- SP-35 EXTERNAL SPEAKER: 2 m (6.5 ft)*
- SP-35L EXTERNAL SPEAKER: 6 m (19.6 ft)*

*Approximate

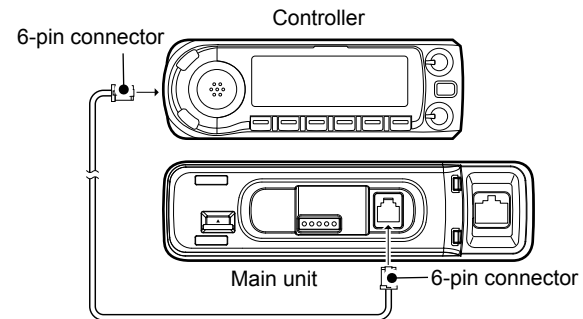

■ Installing the controller

◇ When installing into your vehicle

You can install the controller on the dashboard or the console of your vehicle with the optional MBA-8 CONTROLLER BRACKET and the MBF-1 MOUNTING BASE.

1. Attach the MBF-1 to the dashboard or the console.
① See the MBF-1 instruction manual for details.

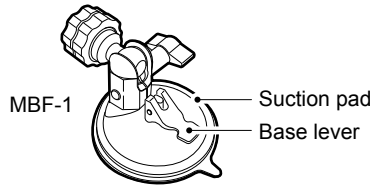

2. Attach the MBA-8 to the controller's rear panel with the supplied longer screws (M2.6 × 8 mm), as shown below.

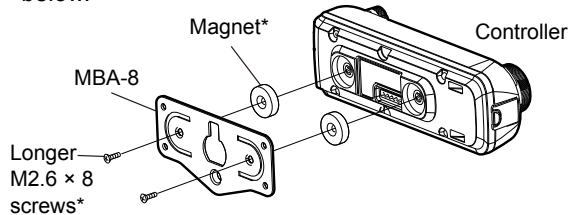

*Supplied with the MBA-8.

3. Slide the MBA-8's guide down over the MBF-1's locking head, as shown below.
① Be sure the locking head fits into the slot at the top of the guide.
4. Tighten the lock knob to securely attach the controller.
5. Adjust the viewing angle of the controller, then tighten the adjustment knob.

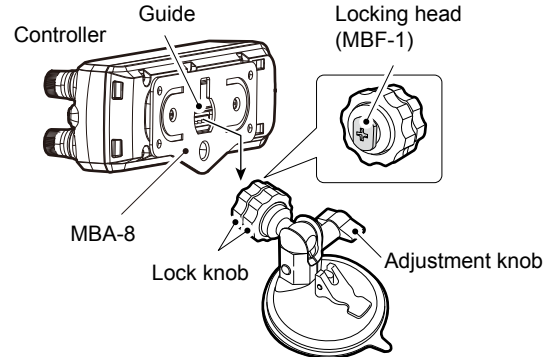

NOTE: There are 2 lengths (6 mm and 8 mm) of screws supplied with the optional MBA-8 controller bracket.

- **NEVER** use any screws other than the supplied screws (M2.6 × 8 mm) to attach the controller bracket. Otherwise the transceiver's internal board may be damaged.
- **NEVER** use any screws other than the supplied screws (M2.6 × 6 mm) to attach the magnets. Otherwise the transceiver's internal board may be damaged.

1 INSTALLATION AND CONNECTIONS

■ Installing the controller (Continued)

◇ Attaching to a flat surface

You can install the controller on a flat surface with the optional MBA-8 CONTROLLER BRACKET. When attaching the MBA-8 to a wall, use self-tapping screws*1 (3 mm, 0.12 in (d)).

1. Attach the MBA-8 to a wall.

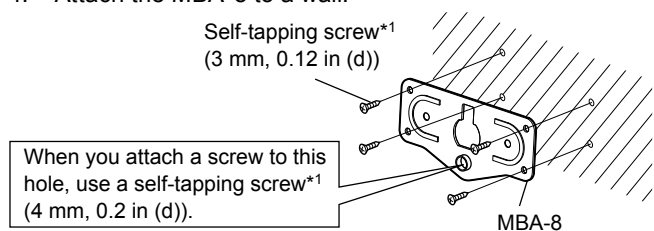

2. Attach the magnets to the controller's rear panel with the supplied shorter screws (M2.6 × 6 mm).

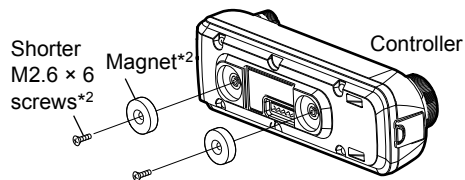

NEVER use any screws other than the supplied shorter screws (M2.6 × 6 mm) to attach the magnets. Otherwise the transceiver's internal board may be damaged.

3. Attach the controller to the MBA-8 that is attached to a wall.

*1 User supplied *2 Supplied with the MBA-8.

■ Connecting a microphone

Plug in the microphone into the microphone jack on the main unit.

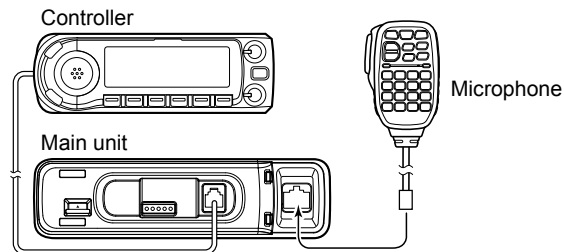

■ Connecting to a DC power supply

Confirm that the transceiver is OFF, then connect to a 13.8 V DC power source with at least 15 A capacity.

⚠ WARNING! NEVER remove the fuse holders from the DC power cable.

CAUTION: DO NOT reverse the polarity when connecting the DC power cable.

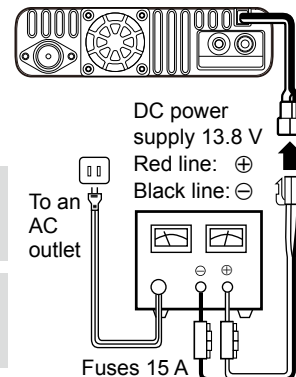

■ Installing in a vehicle

CAUTION: DO NOT place the main unit or remote controller where normal operation of the vehicle may be hindered or where it could cause bodily injury.

CAUTION: DO NOT place the main unit or remote controller where air bag deployment may be obstructed.

CAUTION: DO NOT place the transceiver or remote controller where hot or cold air blows directly onto it.

Installation example

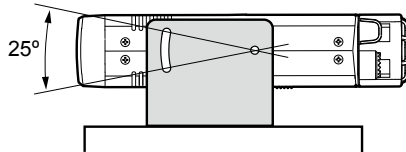
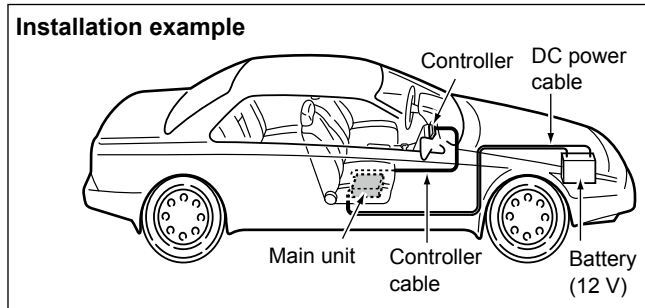

More than 100 mm (3.9 inches) height (recommended)

NOTE: Contact your car dealer or Icom dealer for advice for installing in a vehicle.

You can install the main unit on the dashboard or the console of your vehicle with the optional MBF-4 MOBILE BRACKET.

1. Drill 4 holes where the mounting bracket is to be installed.
 - ① Approximately 5.5 ~ 5.6 mm (0.21 ~ 0.22 inch)(d) when using nuts, approximately 2 ~ 3 mm (0.08 ~ 0.12 inch)(d) when using self-tapping screws.
2. Insert the supplied screws, nuts and washers through the mounting bracket and tighten.
3. Adjust the angle to suit your needs.

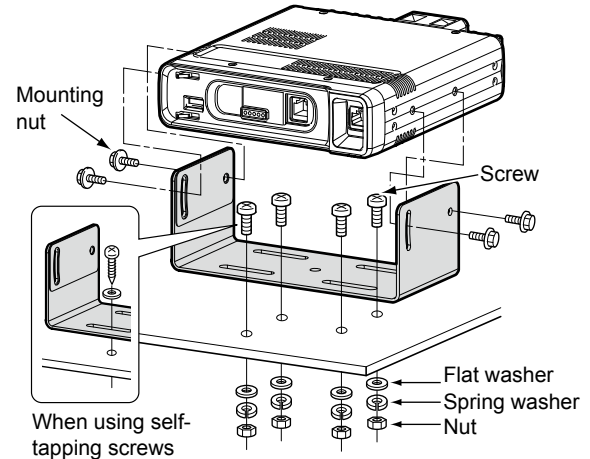

1 INSTALLATION AND CONNECTIONS

■ Installing an antenna

To obtain maximum performance from the transceiver, select a high-quality antenna and mount it in a good location.

Antenna location

Roof-mount antenna

(Drill a hole or use a magnetic mount.)

Gutter-mount antenna

Trunk-mount antenna

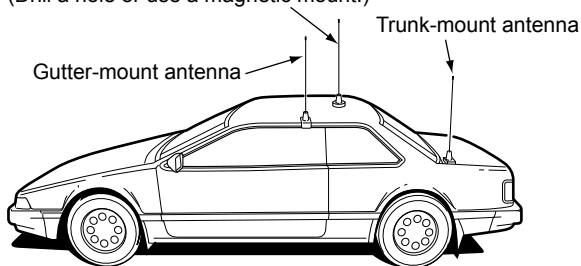

Connect the coaxial cable that the antenna is connected to the antenna connector on the rear panel of the main unit.

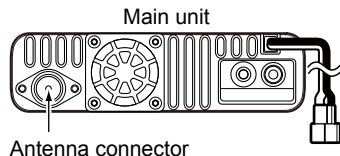

NOTE:

- Make the coaxial cable as short as possible.
- Be sure to seal the antenna connection.

◇ About the antenna

For radio communications, the antenna is of critically importance, along with output power and receiver sensitivity. Select a well-matched 50 Ω antenna and coaxial cable feedline. We recommend 1.5:1 or better Voltage Standing Wave Ratio (VSWR) on your operating bands.

◇ About the internal duplexer

The transceiver has an internal duplexer, and you can easily connect a dual band antenna (VHF/UHF).

If you connect separate the VHF and UHF antennas, use an external duplexer.

When you connect VHF and UHF antennas separately:

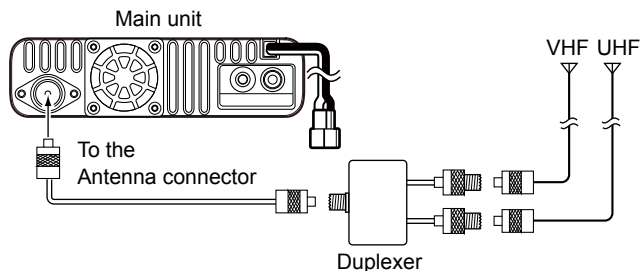

■ Connecting to a battery

⚠ WARNING!

- **NEVER** remove the fuses from the cable connecting the transceiver to a power source, especially a car battery.
- **NEVER** connect the transceiver directly to a 24 V battery. The transceiver must be connected to a 24 V battery through the DC-DC converter.

CAUTION:

- **DO NOT** use a cigarette lighter socket as a power source when operating in a vehicle. The plug may cause voltage drops and ignition noise may be superimposed onto transmit or receive audio.
- **DO NOT** pull or tightly bend the DC power cable.
- **DO NOT** reverse the polarity when connecting the DC power cable.
- Use a rubber grommet when passing the DC power cable through a metal plate to prevent a short circuit.
- The transceiver may not receive well on some frequencies when installed in a hybrid vehicle, or any type of electric vehicle (fuel cell vehicle). This is because vehicle's electric components, such as the inverter system, generate a lot of electrical noise.

CONNECTING TO A VEHICLE BATTERY

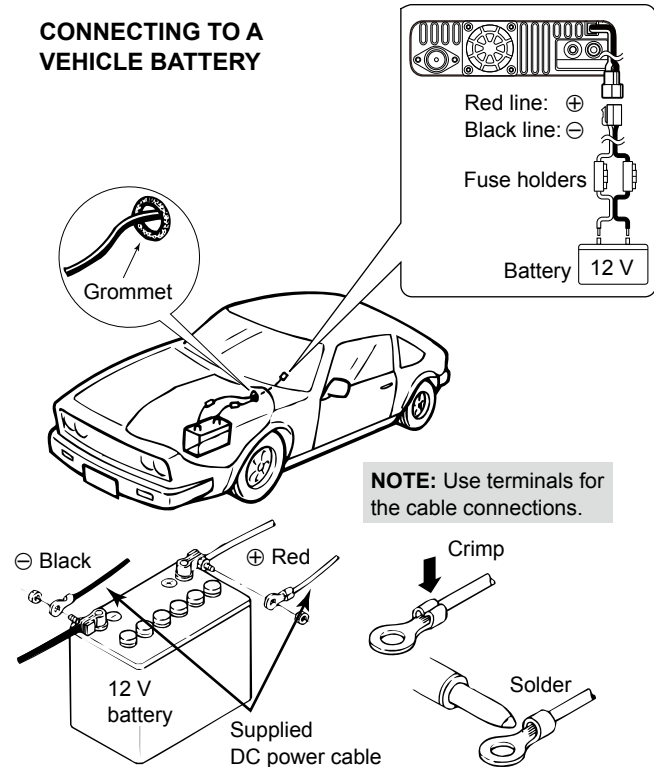

1 INSTALLATION AND CONNECTIONS

■ Installing the UT-137

When you install the optional UT-137 Bluetooth® unit in the transceiver, you can communicate with other Bluetooth device.

WARNING! BE SURE to disconnect the DC power cable before starting the following procedures.

NOTE: Before touching the transceiver or UT-137, remove static electricity from your body by touching a grounded object such as a doorknob or aluminum sash. The static electricity may damage the transceiver or the UT-137, or cause data lost.

1. Turn the transceiver upside-down.
2. Remove the four screws from the bottom of the transceiver and the four screws from the sides, then lift off the bottom cover.

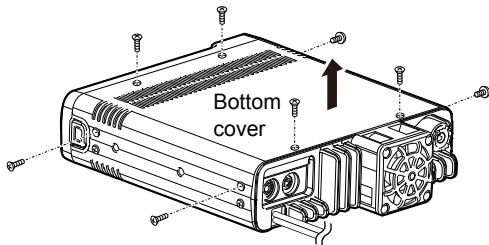

3. Place one end the UT-137 under the edge of the front panel, with the connector facing down.

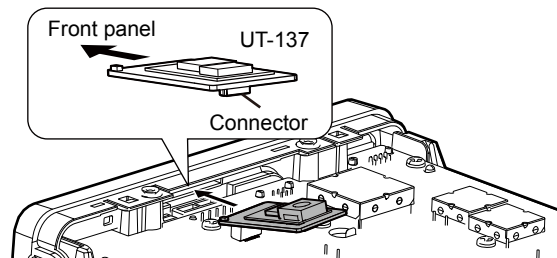

4. Carefully, push the connector into the socket.
① Ensure the UT-137 is installed correctly.

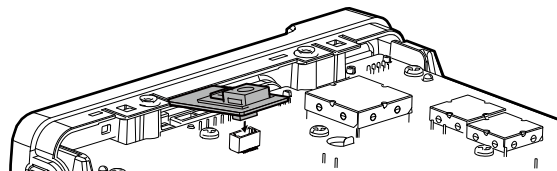

5. Reattach the bottom cover and screws.

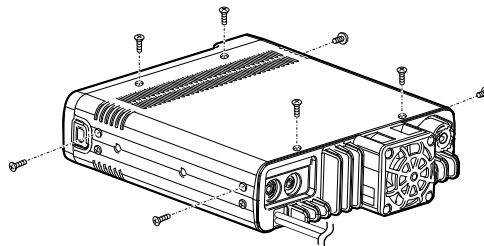

■ Electromagnetic Interference

When you use a Bluetooth device, pay attention to the following:

Bluetooth devices operate on the 2.4 GHz band.

The 2.4 GHz band is also used by other devices, such as Wireless LAN products, microwave ovens, RFID systems, amateur radio stations, and so on.

When using the Bluetooth device near such devices, interference may occur, causing a decrease in communication speed, and an unstable connection. In such cases, use this device away from the other devices, or stop using those devices.

① See the Advance manual for details. (Section 12)

■ Controller — Front panel

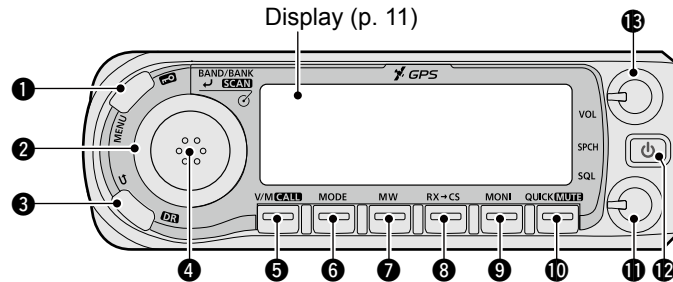

① MENU • LOCK KEY [MENU]/[]

- Push to display the MENU screen. (p. 28)
- Hold down for 1 second to turn the Lock function ON or OFF. (p. 24)

② TUNING DIAL [DIAL]

- Selects an operating frequency in the VFO mode. (p. 23)
- Selects a Memory channel in the Memory mode. (p. 42)
- Selects an option of “TO” or “FROM” on the DR screen.
- Selects a Menu or Quick Menu item.
- Selects an option of the Menu or Quick Menu item.
- Selects a character in the Character Entry mode.

③ BACK • DR KEY []/[DR]

- Push to toggle between “TO” and “FROM” on the DR screen. (p. 24)
- Push to go back a tree level of the MENU screen. (p. 27)
- Hold down for 1 second to display the DR screen. (p. 24)

4 BAND/BANK • ENTER • SCAN KEY**[BAND/BANK]/[J]/[SCAN]**

- In the VFO mode, push to enter the Band Select mode.
- In the Memory mode, push to open the Bank Select window.
- Push to set a Menu or Quick Menu item option.
- Hold down for 1 second to open the Scan Type Select window.
- Hold down for 3 seconds to start the last selected scan.

5 VFO/MEMORY • CALL KEY [V/M]/[CALL] (p. 21)

- Push to toggle between the VFO and Memory modes.
- In the Call channel mode, push to cancel the mode.
- Hold down for 1 second to enter the Call channel mode.

6 MODE KEY [MODE] (p. 22)

Push to select an operating mode.

7 MEMORY WRITE KEY [MW]

- Push to open the Memory Write window.
- Hold down for 1 second to save the operating data into a blank channel. (p. 41)

8 RX CALL SIGN CAPTURE KEY [RX→CS]

- Push to display the RX>CS screen.
- Hold down for 1 second to set the received station call sign as the destination (UR) call sign.

① See the D-STAR Guide that comes with the transceiver for details.

9 MONITOR KEY [MONI]

Push to turn the Monitor function ON or OFF. (p. 19)

10 QUICK MENU • MUTE KEY [QUICK]/[MUTE]

- Push to open the Quick Menu window. (p. 20)
- Hold down for 1 second to turn the Mute function ON or OFF.

11 SQUELCH CONTROL [SQL] (p. 19)

Adjusts the squelch level.

① Normally, set the squelch level to where noise and the "BUSY" icon just disappear. (closed)

① The RF attenuator activates and increases the attenuation when rotated clockwise at beyond the center position.

12 POWER • SPEECH KEY [P]/[SPCH]

- Push to audibly announce the displayed frequency, operating mode or call sign. (p. 25)
- Hold down for 1 second to turn the transceiver ON or OFF. (p. 19)

13 VOLUME CONTROL [VOL] (p. 19)

Adjusts the audio volume level.

2 PANEL DESCRIPTION

■ Controller — Display

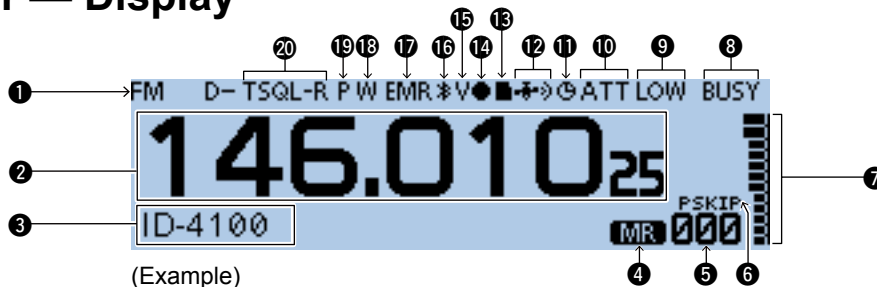

1 MODE ICONS

Displays the selected operating mode.

2 FREQUENCY READOUT

Displays the operating frequency.

3 MEMORY NAME DISPLAY

Display type can be changed in the Quick Menu window. (p. 20)

4 MEMORY MODE ICON

5 MEMORY CHANNEL NUMBER

- Displays the selected Memory channel number, Memory Bank, and so on.
- “WX” is displayed when the Weather channel mode is ON. (Only the USA version transceiver)

6 SKIP ICON

- SKIP: Displayed when Memory Skip is selected.
- PSKIP: Displayed when Program Skip is selected.

7 S/R/F METER

- Displays the relative signal strength of the receive signal.
- Displays the output power level of the transmit signal.

8 BUSY/MUTE/TX ICONS

- BUSY: Displayed while a signal is being received or the squelch is open.
Blinks while the monitor function is activated.
- MUTE: Displayed while the mute is activated.
- TX: Displayed while transmitting.

9 POWER ICONS

Displays the output power level of the transmit signal in three levels (LOW/MID/no icon).
① When you select high power, the power icon disappears.

10 S-METER SQUELCH/ATTENUATOR ICONS

- S SQL: Displayed when the S-meter squelch is activated.
- ATT: Displayed when the Attenuator function is activated.

11 AUTO POWER OFF ICON

Displayed when the Auto power OFF function is ON.



12 GPS ICON

- Displays the status of the GPS receiver. (p. 51)
-  is displayed when you set the GPS alarm.

13 microSD CARD ICON (p. 48)

- Displayed when a microSD card is inserted.
- Blinks while accessing the microSD card.

14 RECORD ICON

- : Displayed while the transceiver is recording.
- : Displayed while the recording is paused.

15 VOX ICON

Displayed when the transceiver is connected to the optional VS-3 Bluetooth® HEADSET, and the VOX function is ON.

16 Bluetooth ICON

Displayed when the transceiver (UT-137 Bluetooth UNIT is installed) connects to a Bluetooth® device.

① See the Advanced manual for details. (Section 12)

17 EMR/BK/PACKET LOSS/AUTO REPLY ICONS

- EMR: Displayed when you select the Enhanced Monitor Request (EMR) mode.
- BK: Displayed when you select the Break-in (BK) mode.
- L: Displayed when packet loss has occurred.
- : Displayed when you select the Automatic Reply function. (p. 33)

18 WEATHER ALERT ICON

Displayed when the Weather Alert function is ON. (Only the USA version transceiver)

19 PRIORITY ICON

Displayed when Priority watch is turned ON.

20 TONE ICONS

Mode: FM/FM-N

- TONE: Enables the subaudible tone encoder.
- TSQL ((·)) : Enables the tone squelch with the Pocket Beep function.
- TSQL: Enables the Tone Squelch function.
- DTCS ((·)) : Enables the DTCS squelch with the Pocket Beep function.
- DTCS: Enables the DTCS Squelch function.
- TSQL-R: Enables the Reverse Tone Squelch function.
- DTCS-R: Enables the Reverse DTCS Squelch function.
- DTCS(T) (“DTCS” blinks):
When you transmit, the selected DTCS code is superimposed on your normal signal.
When you receive, the function is OFF.

2 PANEL DESCRIPTION

■ Controller — Display (Continued)

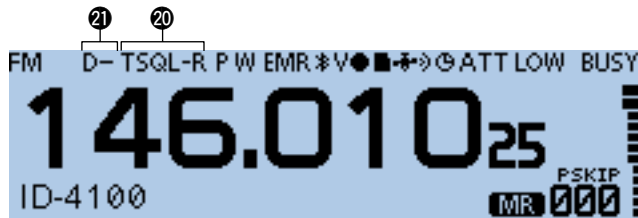

(Example)

② TONE ICONS (Continued)

- TONE(T)/DTCS(R) (“T-DTCS” is displayed, “T” blinks.):
When you transmit, the selected subaudible tone is superimposed on your normal signal.
When you receive, the DTCS squelch opens only for a signal that includes a matching DTCS code and polarity. (Audio is heard)
- DTCS(T)/TSQ(R) (“D-TSQL” is displayed, “D” blinks.):
When you transmit, the selected DTCS code is superimposed on your normal signal.
When you receive, the tone squelch opens only for a signal that includes a matching tone frequency. (Audio is heard)

- TONE(T)/TSQ(R) (“T-TSQL” is displayed, “T” blinks.):
When you transmit, the selected subaudible tone is superimposed on your normal signal.
When you receive, the tone squelch opens only for a signal that includes a matching tone frequency. (Audio is heard)

Mode: DV

- DSQL ((•)): Enables the Digital Call Sign squelch function with the Pocket Beep function.
- DSQL: Enables the Digital Call Sign squelch function.
- CSQ ((•)): Enables the Digital Code squelch function with the Pocket Beep function.
- CSQ: Enables the Digital Code squelch function.

② DUPLEX ICON

- “D-”: Displayed while the minus duplex operation.
- “D+”: Displayed while the plus duplex operation.

■ Main unit — Front panel

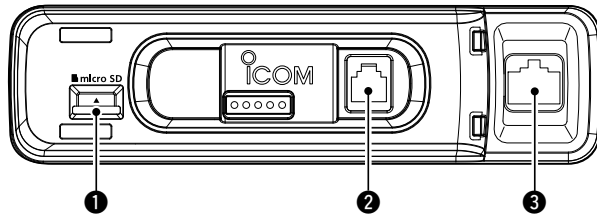

- ❶ **microSD CARD SLOT [micro SD]** (p. 48)
Insert a microSD card (user supplied).
- ❷ **CONTROLLER CONNECTOR** (p. 1)
Connect to the controller using the supplied control cable.
- ❸ **MICROPHONE CONNECTOR**
Connects the supplied or an optional microphone.

◇ Microphone connector information

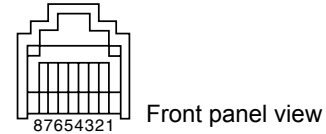

PIN No.	NAME	DESCRIPTION	SPECIFICATIONS
1	8 V	+8 V DC output	Maximum 10 mA
2	MIC U/D	Frequency Up/Down	UP: Ground DN: Ground through 470 Ω
3	M8V SW	Grounds when the HM-207S is connected	—
4	PTT	PTT input	Ground for transmission
5	MIC E	Microphone ground	—
6	MIC	Microphone input	—
7	GND	PTT ground	—
8	DATA IN	When the HM-207S is connected, inputs HM-207S data	—

2 PANEL DESCRIPTION

■ Main unit — Rear panel

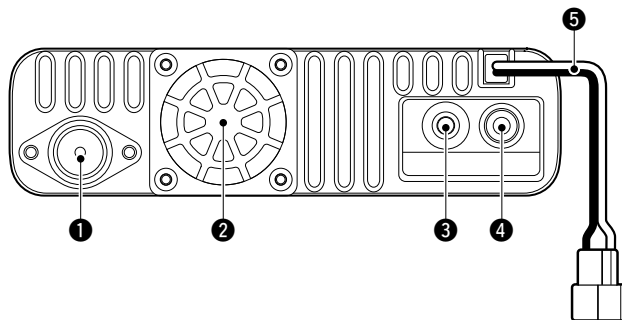

❶ ANTENNA CONNECTOR

Connect to a 50 Ω impedance antenna with a PL-259 connector.

- ❶ The transceiver has a built-in duplexer, so you can use a 144 and 430 MHz dual-band antenna without needing an external duplexer.

❷ COOLING FAN

The cooling fan for heat dissipation.

- ❶ You can select the Fan control option in the MENU screen, and automatically start to rotate when you begin transmitting, or continuously rotate from power ON.

❸ DATA JACK [DATA]

Connect to a PC through the optional data communication cable, for cloning or data communication in the DV mode. 2.5 mm (0.09 in) (d)

❹ EXTERNAL SPEAKER JACK

Connect to an 8 Ω external speaker. 3.5 mm (0.13 in) (d)

❺ DC POWER SOCKET [DC 13.8V]

Connect to a 13.8 V DC power source through the supplied DC power cable.

■ Microphone (HM-207S)

With the HM-207S, you can input numbers for frequency or Memory channel setting, and easily adjust the audio volume or squelch level.

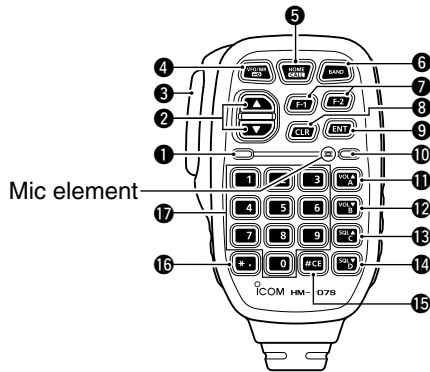

- ① **LED 1**
Lights red while holding down [PTT].
- ② **[▲]/[▼] (UP/DOWN) KEYS**
 - Push to change the operating frequency or Memory channel.
 - Hold down to continuously change the frequency or Memory channel.

- ③ **[PTT] SWITCH**
Hold down to transmit, release to receive.

NOTE: To maximize the readability of your signal, hold the microphone 5 to 10 cm (2 to 4 inches) from your mouth, then speak at your normal voice level.

- ④ **[VFO/MR] KEY**
 - Push to toggle between the VFO and Memory modes.
 - Hold down for 1 second to turn the Lock function ON or OFF.
- ⑤ **[HOME/CALL] KEY**
 - Push to select the Home channel.
 - Hold down for 1 second to enter or cancel the Call channel mode.
- ⑥ **[BAND] KEY**
Push to select the operating bands.
- ⑦ **[F-1] KEY**
Push to activate the preset function of the [F-1] key.
(Default: During RX/Standby: [MODE]
During TX: [T-CALL])
- [F-2] KEY**
Push to activate the preset function of the [F-2] key.
(Default: During RX/Standby: [Monitor]
During TX: [---])

TIP: You can assign a function in the MENU screen.

2 PANEL DESCRIPTION

■ Microphone (HM-207S) (Continued)

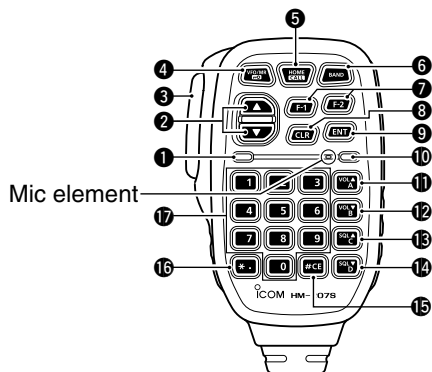

8 [CLR] KEY

Push to cancel the MENU screen or Quick Menu window, then return to the standby screen.

9 [ENT] KEY

- In the VFO mode, push to enter the Frequency Entry mode.
- In the Memory mode, push to enter the Memory Channel Number Entry mode.
- After entering the number, push to set.

10 LED 2

Lights green when transceiver's power is ON.

11 [VOL▲/A] KEY

- Push to increase the audio output level.
- In the DTMF Code Entry mode, push to input 'A.'

12 [VOL▼/B] KEY

- Push to decrease the audio output level.
- In the DTMF Code Entry mode, push to input 'B.'

13 [SQL▲/C] KEY

- Push to increase the squelch level.
- In the DTMF Code Entry mode, push to input 'C.'

14 [SQL▼/D] KEY

- Push to decrease the squelch level.
- In the DTMF Code Entry mode, push to input 'D.'

15 [#/CE] KEY

- In the Frequency Entry mode, push to delete a number.
- In the DTMF Code Entry mode, push to input '#.'

16 [*./] KEY

- In the Frequency Entry mode, push to input a '.' (decimal point).
- In the DTMF Code Entry mode, push to input '*'.

17 [0] to [9] KEYS

In the Frequency or DTMF Code Entry mode, push to input '0' through '9.'

◇ Setting the frequency and Memory channels

Example of frequency setting:

- First, push [VFO/MR] to select the VFO mode.

To enter the frequency 435.680 MHz:

- Push [4], [3], [5], [6], [8], [0], then [ENT].

To change 435.680 MHz to 435.540 MHz:

- Push [•], [5], [4], [0], then [ENT].

To enter the 433.000 MHz frequency:

- Push [4], [3], [3], then [ENT].

Example of Memory channel setting:

- First, push [VFO/MR] to select the Memory mode.

To select Memory channel '5':

- Push [5] then [ENT].

■ Turning ON the transceiver

Hold down [⏻] for 1 second to turn ON the transceiver.

- A beep sounds.
 - After the opening message and power source voltage are displayed, the operating frequency or repeater name is displayed.
- ① Hold down [⏻] for 1 second again to turn OFF the power.

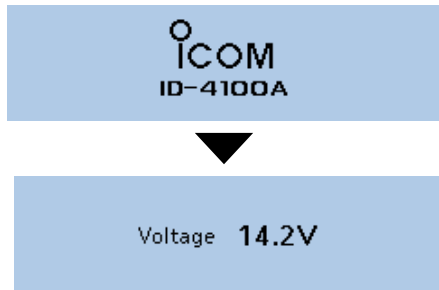

■ Monitor function

The Monitor function is used to listen to weak signals without disturbing the squelch setting.

Push [MONI] to open or close the squelch.

- “BUSY” blinks and audio is heard when the squelch is open.

■ Setting audio volume and squelch level

1. Rotate [VOL] to adjust the audio level.
2. Rotate [SQL] until the noise and “BUSY” just disappear.

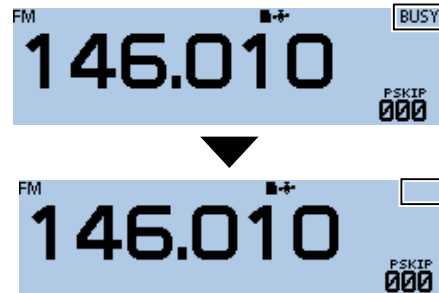

- Rotating [SQL] clockwise makes the squelch tight. Tight squelch is for strong signals.
- When rotating [SQL] clockwise beyond the center position, [SQL] can be used as ‘S-meter Squelch’ or ‘Attenuator.’ Select the [SQL] option in the MENU screen. (p. 35) (Function > **Squelch/ATT Select**)

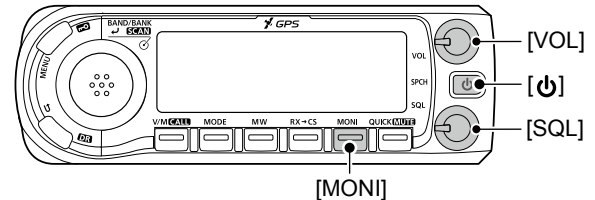

■ Quick Menu window

You can open the Quick Menu window by pushing [QUICK]. In the window, the selectable items differ, depending on the operating mode or function. The items listed below are examples.

VFO mode	Memory mode	Call CH mode	DR function
Band Select	Bank Select	TX Power	Group Select
TX Power*1	TX Power*1	DUP	Repeater Detail
DUP	DUP	TONE*1	TX Power
TONE*1*2	TONE*1*2	TS	DTMF TX
MHz	TS	DTMF TX	Voice TX
TS	SKIP	Voice TX	RX History
DTMF TX	DTMF TX	RX History*3	GPS Information
Voice TX	Voice TX	GPS Information	GPS Position
RX History*3	RX History*3	GPS Position	Weather Information*4
GPS Information	GPS Information	Weather Information*4	PRIO Watch
GPS Position	GPS Position	PRIO Watch	Weather CH*5
Weather Information*4	Weather Information*4	Weather CH*5	Weather Alert*5
PRIO Watch	PRIO Watch	Weather Alert*5	Home CH Set
Weather CH*5	Weather CH*5	Display Type	DSQL
Weather Alert*5	Weather Alert*5	Clock	SKIP
Home CH Set	Home CH Set	Voltage	Clock
Clock	Display Type	Band Scope	Voltage
Voltage	Clock	<<REC Start>>	<<REC Start>>
Band Scope	Voltage		
<<REC Start>>	Band Scope		
	<<REC Start>>		

◇ Quick Menu window operation

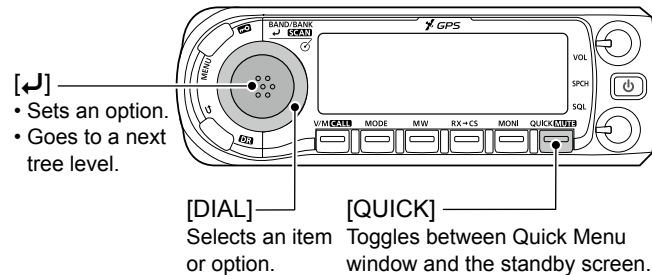

Simplified description—‘Select’ operation

In this manual, user’s ‘Select’ operation is simplified.

Simplified description:

1. Push [QUICK].
2. Select “TX Power,” then push [DIAL].

Operation:

1. Push [QUICK] to open the Quick Menu window.
2. Rotate [DIAL] to select “TX Power,” then push [DIAL].

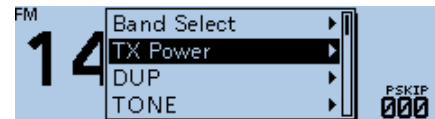

*1 Disappears in the AM mode.

*2 “DSQL” is displayed in the DV mode.

*3 Displayed in only the DV mode.

*4 Displayed when the D-PRS TX format is set to “Weather.”

*5 Displayed in only the USA version transceivers.

3 BASIC OPERATION

■ Selecting the Mode

◇ VFO mode

You use the VFO mode to set the operating frequency.

◇ Memory mode

You use the Memory mode to operate on Memory channels.

◇ Call channel mode

You use the Call channel mode to operate on the Call channels.

1. Push [V/M] several times until you enter the VFO or Memory mode.
 - In the Memory mode, **MR** and the selected Memory channel number are displayed.

① Information

- Pushing [V/M] toggles between the VFO and Memory modes.
 - To enter the Call channel mode, hold down [CALL] for 1 second.
 - In the Call channel mode, “144 C0,” “144 C1,” “430 C0,” or “433 C1” is displayed.
 - In the Call channel mode, push [CALL] to cancel the mode.
2. Rotate [DIAL] to select an operating frequency or a channel.

◇ Weather channel mode

(Selectable in only the USA version transceivers)

You can use the Weather channel mode to hear weather broadcasts from the National Oceanographic and Atmospheric Administration (NOAA) broadcasts.

1. Push [QUICK].
 2. Rotate [DIAL] to select “Weather CH,” then push [↵].
 - The selected weather channel number (“WX-01” to “WX-10”) is displayed.
- ① To cancel the mode, select “Weather CH OFF” in the Quick Menu window.

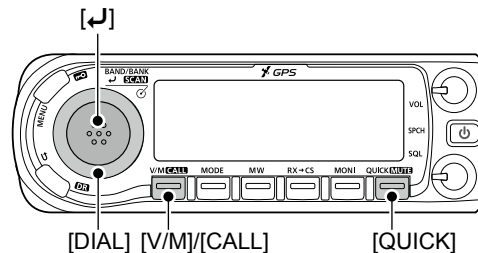

■ Selecting the operating band

The transceiver can receive on the AIR, 144 MHz, 230 MHz, 300 MHz, and 430 MHz bands.*

You can transmit on only the amateur band frequencies.

*Selectable band differs, depending on the transceiver's version.

1. Push [V/M] several times until you enter the VFO mode.
2. Push [BAND].
 - Enters the Band Select mode.



3. Rotate [DIAL] to select an operating band.
4. Push [↵].
 - Sets the band, then returns to the standby screen.

TIP: You can select the operating band in the Quick Menu window.

1. Push [QUICK].
2. Rotate [DIAL] to select “Band Select,” then push [↵].
3. Select an operating band, then push [↵].

■ Selecting the operating mode

The transceiver has a total of 5 operating modes, AM, AM-N, FM, FM-N, and DV.

By pushing [MODE], you can select an operating mode.

① Information

- You can select the AM mode for only the AIR, 230 MHz, and 300 MHz bands.
- You can select the AM-N mode for only the AIR band.
- You can select the FM, FM-N, or DV modes for only the 144 MHz, 230 MHz, 300 MHz, and 430 MHz bands.
- While in the FM-N mode, the TX modulation is automatically set to narrow (approximately ± 2.5 kHz).
- When you set the “GPS TX Mode” item to “D-PRS” or “NMEA,”  is displayed besides the mode icon. See the Advanced manual for details. (Section 5)

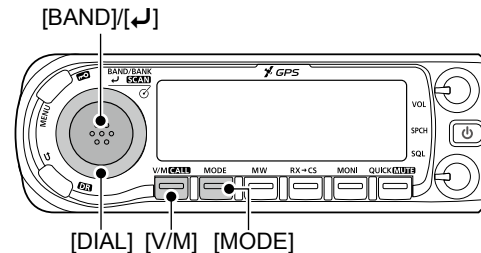

3 BASIC OPERATION

■ Setting a frequency

◇ Selecting a tuning step

If you select the operating frequency by rotating [DIAL] in the VFO mode, the frequency changes in the selected tuning step.

① The VFO mode scan and the Band Scope function also use this step to search for a signal.

1. Push [QUICK].
2. Rotate [DIAL] to select “TS,” then push [↵].
3. Select a tuning step, then push [↵].

Options (kHz):

5.0	6.25	8.33*	10.0	12.5	15
20	25	30	50	Auto*	

*Selectable only in the AIR band mode.

• Sets the tuning step, then returns to the standby screen.

① You can set the tuning step for both the VFO and Memory mode.

① You can set the tuning step for each band.

◇ Selecting the 1 MHz tuning

You can change the operating frequency in ‘MHz’ steps for quick tuning.

1. Push [QUICK].
2. Rotate [DIAL] to select “MHz,” then push [↵].
 - Enters the 1 MHz Tuning Select mode.



3. Rotate [DIAL].
 - The frequency changes in 1 MHz steps.
4. Push [↵].
 - Sets the frequency, then returns to the standby screen.

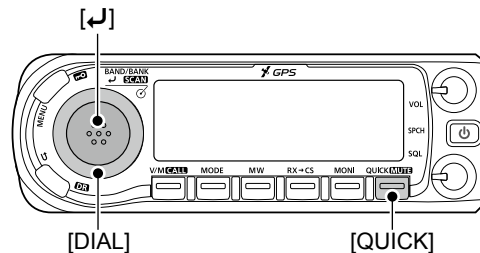

■ Lock function

You can use the Lock function to prevent accidental frequency changes and unnecessary function access.

Hold down [LOCK] for 1 second to turn the Lock function ON or OFF.

- “LOCK ON” or “LOCK OFF” is briefly displayed when the Lock function is turned ON or OFF.
- ① When the Lock function is ON and you operate the transceiver, “LOCK” is displayed.
- ① You can still use [V], [PTT], [SQL], [VOL] and [MONI], even if the Lock function is ON.

■ DR function

The DR (D-STAR Repeater) function is for D-STAR repeater operation. This function enables you to easily select the preset repeaters and UR call signs by rotating [DIAL]. See the D-STAR Guide that comes with the transceiver for details of registering your call sign at a gateway repeater, or basic D-STAR operation.

1. Hold down [DR] for 1 second.
 - Displays the DR screen.
2. Push [DR] several times until you select “FROM.”

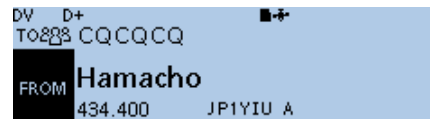

3. Rotate [DIAL] to select an access repeater.
 - ① To cancel the DR screen, hold down [DR] for 1 second.

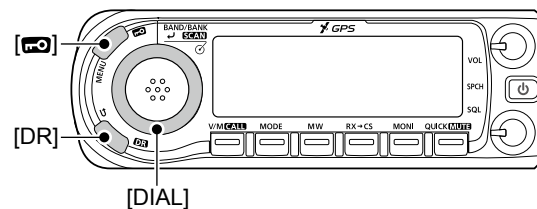

3 BASIC OPERATION

■ Speech function

The Speech function audibly announces information after pushing [SPCH]. Also, you can set various Speech functions, such as the DIAL Speech function or Mode Speech function on the MENU screen. (p. 34)

① Information

- In the VFO, Memory, or Call channel mode, the Speech function announces the displayed frequency and operating mode.
- When using the DR function, the Speech function announces the displayed call sign.
- When you push [SPCH] while recording the received audio in the DV mode, the received audio will be muted, and no audio is recorded onto the microSD card. In modes other than the DV mode, the received audio will be recorded.



One, four, six, point, zero, one, megahertz, FM.

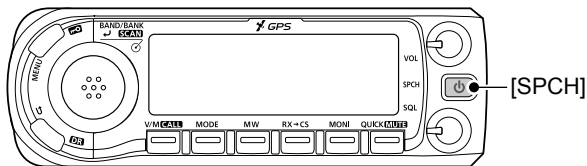

■ Home Channel function

You can set an often-used frequency, Memory channel, or repeater as the Home channel in each mode (VFO/Memory/DR). The Home channels are selectable by pushing [HOME] on the microphone in each mode.

◇ Setting a Home channel

1. Select the VFO or Memory mode, or the DR screen to set a Home channel. (pp. 21, 24)
2. Select a frequency, Memory channel, or an access repeater to be set as a Home channel. (pp. 23, 24, 42)
3. Push [QUICK].
4. Rotate [DIAL] to select "Home CH Set," then push [↵].
5. Select "Set Frequency" (VFO mode), "Set Channel" (Memory mode), or "Set Repeater" (DR screen), then push [↵].

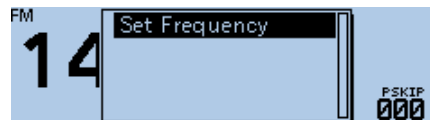

- Sets a Home channel, then returns to the standby screen.

■ Transmitting

◇ Transmitting on an Amateur band

Before transmitting, monitor the operating frequency to make sure transmitting won't cause interference to other stations on the same frequency.

CAUTION: DO NOT transmit without an antenna. This may damage the transceiver.

NOTE: You can transmit on only the amateur band frequencies.

1. Rotate [DIAL] to set the operating frequency. (p. 23)
2. Push [QUICK].
3. Rotate [DIAL] to select "TX Power," then push [↵].
 - Opens the TX Power Select window.
4. Select the transmit output power level, then push [↵].
 - ① Select a level to suit your operating requirements.
 - ① When you select high power, the power icon disappears.
5. Hold down [PTT] to transmit, and speak at your normal voice level.
 - Displays **TX** while transmitting.
 - The S/R/F meter displays the output power level.



6. Release [PTT] to receive.

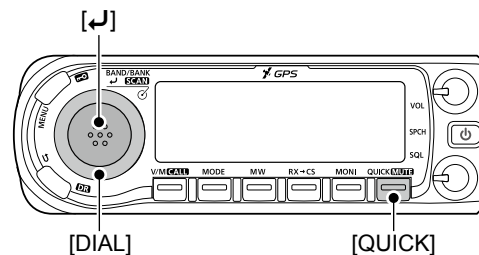

■ MENU screen description

The MENU screen is displayed after pushing [MENU]. You can use the MENU screen to set infrequently changed values or function settings.

See the following pages for details of each set screen.

DUP/TONE...	p. 28	DTMF	p. 34
Manage Memory	p. 29	QSO/RX Log	p. 34
Scan	p. 29	Function	p. 35
Voice Memo	p. 29	Display	p. 36
Voice TX	p. 30	Sounds	p. 37
GPS	p. 30	Time Set	p. 38
Call Sign	p. 32	DV Gateway	p. 38
RX History	p. 33	SD Card	p. 38
DV Memory	p. 33	Bluetooth Set	p. 39
My Station	p. 33	Others	p. 40
DV Set	p. 33		
SPEECH	p. 34		

TIP: The MENU screen is constructed in a tree structure. You may go to the next tree level, or go back a level, depending on the selected item.

■ Selecting a Menu item

◇ MENU screen operation

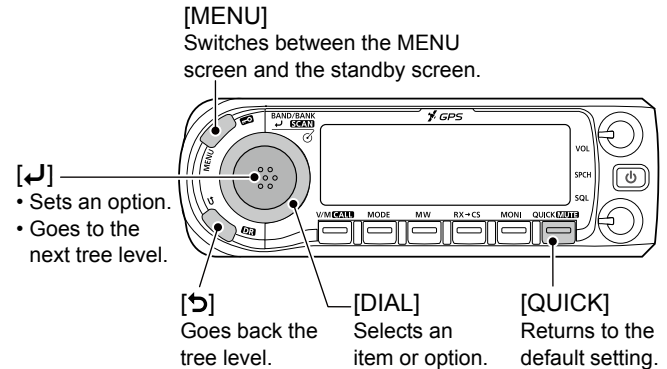

Simplified description—'Select' operation

In this manual, user's 'Select' operation is simplified as shown below.

Simplified description:

Select "30min."

Operation:

Rotate [DIAL] to select "30min."

◇ Selecting a Menu item

Example: Set the “Auto Power OFF” item to “30 min.”

Time Set > Auto Power OFF

1. Push [MENU].
2. Rotate [DIAL] to select “Time Set,” then push [↵].
3. Select “Auto Power OFF,” then push [↵].
4. Select “30min,” then push [↵].
 - Sets the option, then goes back a tree level. (TIME SET screen is displayed.)
5. Push [MENU].
 - Returns to the standby screen.

TIP: To return to the default setting:

1. Push [QUICK] in step 4.
2. Select “Default,” then push [↵].

■ Menu items and their details

This topic describes the Menu items and their details. See the Advanced manual for details. (Section 9)

DUP/TONE...

Settings to access repeaters.

Offset Freq

Sets the frequency offset for duplex (repeater) operation.

Repeater Tone

Selects a tone frequency used to access the repeaters.

TSQL Freq

Selects a tone frequency for the Tone Squelch or the Pocket Beep function.

Tone Burst

Turns the Tone Burst function ON or OFF.

This function is used to suppress the squelch tail noise of FM mode on the RX side, if you transmit a signal which superimposes the CTCSS tone or subaudible tone.

DTCS Code

Selects a DTCS (both encoder/decoder) code for DTCS Squelch or the Pocket Beep function.

DTCS Polarity

Selects the DTCS polarity for the DTCS Squelch or the Pocket Beep function.

Digital Code

Selects a digital code for the Digital Code Squelch function.

4 MENU SCREEN

■ Menu items and their details (Continued)

Manage Memory

Manages for your Memory or Call channel data.

Memory CH

Manages for the Memory channels.

Call CH

Manages for the Call channels.

Scan

Set scan options.

Pause Timer

Selects the Scan Pause time. When receiving signals, the scan pauses according to this set period of time.

Resume Timer

Selects the Scan Resume time from a pause after the received signal disappears.

Temporary Skip Timer

Selects the Temporary Skip time. When the time is set, specified frequencies are skipped for this set period of time during a scan.

Program Skip

Turns the Program Skip Scan function ON or OFF for a VFO mode scan.

Bank Link

Selects banks to be scanned during a Bank Link scan.

Program Scan Edge

Sets the frequency ranges for a Program scan.

Program Link

Sets the Link function for the Program Scan Edge channels.

Voice Memo

Set the TX/RX voice recording options.

QSO Recorder

Set QSO recorder options.

<<REC Start>>*

Starts recording the received signal audio.

Play Files*

Plays the recorded audio.

Recorder Set

REC Mode

Selects whether or not to record the TX audio.

RX REC Condition

Selects whether or not the squelch status affects the RX voice audio recording.

File Split

Selects whether or not to automatically create a new file if transmission and reception, or squelch status (open and close) is changed.

PTT Auto REC

Turns the PTT Automatic Recording function ON or OFF.

Player Set

Skip Time

Sets the Skip time to rewind or forward the recorded audio when you push the fast-rewind or fast-forward key during playback.

DV Auto Reply*

Records a voice audio to use for the Auto Reply function in the DV mode.

*A microSD card is required.

Voice TX

Set microphone voice recording options.

Record*

Starts recording the microphone audio.

TX Set**Repeat Time**

Sets the repeat interval. The transceiver repeatedly transmits the recorded voice audio at this interval.

TX Monitor

The TX Monitor function outputs the TX voice audio from the speaker during voice transmission.

<<TX>>*

The transceiver transmits the recorded voice audio.

GPS

Set GPS options.

GPS Set**GPS Select**

Selects either the internal or an external GPS receiver that the transceiver receives its position data from.

Manual Position

Manually enter your current position.

GPS Out (To DATA jack)

Turns the output of GPS information from the internal GPS receiver to the [DATA] jack ON or OFF.

GPS TX Mode

Set the GPS TX mode.

OFF

Turns OFF the GPS TX function.

D-PRS (DV-A)

(GPS > GPS TX Mode)

Set D-PRS options.

Unproto Address

Enters an unproto address, or keeps the default.

TX Format**Position****Symbol**

Selects a D-PRS Symbol to transmit.

SSID

Selects the APRS® call sign SSID.

Comment

Enters a comment to transmit.

Time Stamp

Selects the format to transmit the current UTC time as a time stamp.

Altitude

Turns the altitude transmit option ON or OFF.

Data Extension

Selects whether or not to transmit the course/speed, power/height/gain/directivity data.

Power

Selects a base station's TX power level to transmit.

Height

Selects a base station's height to transmit.

Gain

Selects a base station's antenna gain to transmit.

Directivity

Selects a base station's antenna directivity to transmit.

*A microSD card is required.

4 MENU SCREEN

■ Menu items and their details (Continued)

Object (GPS > GPS TX Mode > TX Format)

Set Object data such as an earthquake information, satellite track information, and so on, to transmit along with the position data. An Object contains a time stamp.

Object Name

Enters an Object's name to transmit.

Data Type

Selects an Object's status to transmit.

Symbol

Selects an Object's symbol to transmit.

Comment

Enters an Object's comment to transmit.

Position

Sets an Object's position data to transmit.

Data Extension

Selects whether to transmit the Object's course/speed data, power/height/gain/directivity data or not.

Course

Sets an Object's course to transmit.

Speed

Sets an Object's speed to transmit.

Power

Selects an Object's TX power level to transmit.

Height

Selects an Object's height to transmit.

Gain

Selects an Object's antenna gain to transmit.

Directivity (GPS > GPS TX Mode > TX Format > Object)

Selects an Object's antenna directivity to transmit.

SSID

Selects an Object's APRS® call sign SSID.

Time Stamp

Selects a format to transmit the current UTC time as a time stamp.

Item (GPS > GPS TX Mode > TX Format)

Set Item data such as a traffic accident, lighthouse, antenna, or DV access point location, and so on, to transmit along with the position data. An Item does not contain a time stamp.

Item Name

Enters an Item's name to transmit.

Data Type

Selects an Item's status to transmit.

Symbol

Selects an Item's symbol to transmit.

Comment

Enters an Item's comment to transmit.

Position

Sets an Item's position data to transmit.

Data Extension

Selects whether to transmit the item's course/speed data, power/height/gain/directivity data or not.

Course

Sets an Item's course to transmit.

Speed

Sets an Item's speed to transmit.

Power

Selects an Item's TX power level to transmit.

Height (GPS > GPS TX Mode > TX Format > Item)

Selects an Item's height to transmit.

Gain

Selects an Item's antenna gain to transmit.

Directivity

Selects an Item's antenna directivity to transmit.

SSID

Selects an Item's APRS® call sign SSID.

Weather (GPS > GPS TX Mode > TX Format)**Symbol**

Selects a weather station's symbol to transmit.

SSID

Selects the APRS® call sign SSID for the weather station.

Comment

Enters a weather station's comment to transmit.

Time Stamp

Selects a format to transmit the current UTC time as a time stamp.

NMEA (DV-G) (GPS > GPS TX Mode)

Set NMEA options.

GPS Sentence

Transmits position data in selected GPS sentences.

GPS Message

Enter a GPS message to be transmitted.

GPS Information

Displays the received GPS information.

GPS Position

Displays your position, RX station, GPS memory and Alarm positions.

GPS Memory

Shows the GPS memory contents.

GPS Alarm

Set GPS alarm options.

Alarm Select

Select the target for the GPS alarm function.

Alarm Area (Group)

Enter the GPS alarm active range.

Alarm Area (RX/Memory)

Select the GPS alarm active range.

GPS Logger***GPS Logger**

Turns the GPS logger function ON or OFF, to store your route as you move.

Record Interval

Selects the GPS Logger function record interval.

Record Sentence

Selects the GPS Logger function record sentences.

GPS Auto TX

Selects a time option for the GPS automatic transmission function.

Call Sign

Set and display the DV mode call signs.

UR: CQCQCQ, R1: -----, R2: -----, MY: -----

Displays the operating call signs.

Sets the operating call signs according to the type of call you want to make.

*A microSD card is required.

4 MENU SCREEN

■ Menu items and their details (Continued)

RX History

Displays the received call history in the DV mode.

RX01:

Displays the calls your transceiver received.

DV Memory

Stores call signs or repeater information to use in the DV mode.

Your Call Sign

Stores station call signs. Add or edit call signs.

Repeater List

Stores repeater information. Add or edit repeater information.

NOTE: The repeater list described in this manual may differ from your preloaded list.

My Station

Sets and stores MY call sign to use in the DV mode.

My Call Sign

Stores MY call signs.

Select or edit a MY call sign to use in the DV mode.

TX Message

Stores TX Messages.

Select or edit TX Message to use in the DV mode.

DV Set

Sets values for the DV mode operations.

Tone Control

Set the received audio tones.

RX Bass (DV Set > Tone Control)

Sets the DV mode received audio bass filter level to Cut, Normal or Boost.

RX Treble

Sets the DV mode received audio treble filter level to Cut, Normal or Boost.

RX Bass Boost

Turns the DV mode received audio Bass Boost function ON or OFF.

TX Bass

Sets the DV mode transmit audio bass filter level to Cut, Normal or Boost.

TX Treble

Sets the DV mode transmit audio treble filter level to Cut, Normal or Boost.

Auto Reply

Selects the Automatic Reply function.

DV Data TX

Selects manually or automatically to transmit data.

DV Fast Data

The DV Fast data mode sends data through both the audio and data frames in the DV mode. The data speed of the DV Fast data mode (approximately 3480 bps) is 3.5 times faster than the low-speed data communication mode (approximately 950 bps). In the DV Fast data mode, no audio can be sent.

Fast Data

Selects whether or not to use DV Fast data mode for data communication in the DV mode.

GPS Data Speed

Set the GPS data transmission speed in the DV Fast data mode.

TX Delay (PTT) (DV Set > DV Fast Data)

Set the TX delay time after releasing [PTT] when the "DV Data TX" is set to "PTT" and data is sent in the DV Fast data mode.

Digital Monitor

Selects the DV mode RX monitoring when [SQL] is held down.

Digital Repeater Set

Turns the digital repeater setting function ON or OFF. This function is usable in any DV mode except when using the DR function.

DV Auto Detect

Turns the DV mode automatic detect function ON or OFF.

RX Record (RPT)

The transceiver can record the data of up to 50 individual calls.

BK

Turns the BK (Break-in) function ON or OFF. The BK function enables you to break into a conversation between two stations with call sign squelch enabled.

EMR

Turns the EMR (Enhanced Monitor Request) communication mode ON or OFF.

After turning OFF the transceiver, the EMR mode will be cancelled.

EMR AF Level

Sets the audio output level when an EMR mode signal is received.

SPEECH

Sets the Speech functions.

RX Call Sign SPEECH

Selects the RX call sign speech function option while ON, or turn it OFF.

RX>CS SPEECH

Turns the RX>CS Speech function ON or OFF.

DIAL SPEECH

Turns the Dial Speech function ON or OFF.

MODE SPEECH

Turns the Operating Mode Speech function ON or OFF.

SPEECH Language

Selects either English or Japanese as the speech language.

Alphabet

Selects the alphabet character announcement type.

SPEECH Speed

Selects Slow or Fast speech speed.

SPEECH Level

Sets the volume level for the voice synthesizer.

DTMF

Sets the DTMF Memory functions.

DTMF Memory

Shows a list of the DTMF memory channels. The DTMF memory can store up to 24-digit DTMF code.

DTMF Speed

Selects the DTMF transfer speed.

QSO/RX Log

Sets the QSO/RX History Log options.

QSO Log*

Selects whether or not to make a communication log on the microSD card.

RX History Log*

Selects whether or not to make a DV mode's receive history log on the microSD card.

*A microSD card is required.

4 MENU SCREEN

■ Menu items and their details (Continued)

CSV Format (QSO/RX Log)

Set CSV format options.

Separator/Decimal

Selects the separator and the decimal character for the CSV format.

Date

Selects the date format.

Function

Sets various function's options.

Squelch/ATT Select

Selects to use the S-Meter Squelch or the Attenuator function for the [SQL] control.

Squelch Delay

Selects to shorten or lengthen the time until the squelch opens.

Fan Control

Selects the cooling fan control condition.

Dial Speed-UP

Turns the dial speed acceleration ON or OFF.

Auto Repeater*

Turns the Auto Repeater function ON or OFF.

Remote MIC Key

Selects the key function for [F-1] or [F-2] on the supplied remote-control microphone.

During RX/Standby

Selects the key function to be used while receiving or in the standby mode.

During TX

Selects the key function to be used while transmitting.

Up/Down MIC Key

Selects the key function for [UP] or [DN] on the optional hand microphone.

During RX/Standby

Selects the key function to be used while receiving or in the standby mode.

During TX

Selects the key function to be used while transmitting.

One-Touch PTT(Remote MIC)

Turns the One-Touch PTT function ON or OFF.

PTT Lock

Turns the PTT Lock function ON or OFF.

Busy Lockout

Turns the Busy Lockout function ON or OFF.

Time-Out Timer

Selects the Time-Out Timer time options.

Active Band

Enables continuous frequency selection across all bands by rotating [DIAL].

MIC Gain

Sets the microphone sensitivity to suit your preference.

Data Speed

Selects the data transmission speed for low-speed communication, or between the [DATA] jack and external modules like a GPS receiver, and so on.

CI-V

Set CI-V options.

*Does not appear, depending on the transceiver version.

CI-V Address (Function > CI-V)

Sets the transceiver's unique CI-V hexadecimal address code.

CI-V Baud Rate

Sets the CI-V code transfer speed.

CI-V Transceive

Turns the CI-V Transceive function ON or OFF.

CI-V Bluetooth → REMOTE Transceive Address

Sets the address to inhibit the external control with CI-V for the transceiver through the [SP2] (REMOTE) jack.

Power OFF (With No Controller)

Selects whether or not to automatically turn OFF the transceiver when the controller is disconnected from the transceiver.

Display

Sets the Display options.

LCD Backlight Brightness

Selects the LCD backlight brightness level.

LCD Backlight Color

Selects the LCD backlight color.

Key Backlight Brightness

Selects the key backlight brightness level.

Key Backlight Color

Selects the key backlight color.

Backlight Night Time Setting**Night Time Setting**

Selects whether or not to turn down the backlight brightness for nighttime operation.

Brightness

Selects the backlight brightness level for nighttime operation.

Night Time Start

Sets the start time for nighttime operation.

Night Time End

Sets the end time for nighttime operation.

Auto Dimmer Setting**Auto Dimmer**

Sets the Auto Dimmer function for nighttime operation.

Auto Dimmer Timer

Sets the time period until the backlight turns OFF when the "Auto Dimmer" item is set to "Auto-OFF" or "Auto-1" to "Auto-3."

Auto Dimmer Cancel (PTT)

Selects the transceiver operation when [PTT] is pushed while the Auto Dimmer is activated.

Auto Dimmer Cancel (DV RX)

Selects the transceiver operation when receiving a DV signal while the Auto Dimmer is activated.

LCD Contrast

Sets the contrast level of the LCD.

RX Call Sign

Selects the call sign and message display option when receiving a call.

RX Position Indicator

Selects whether or not to display the indicator when the position data is included in the signal received in the DV mode.

RX Position Display

Selects whether or not to display the caller's position data in a dialog when the data is included in the signal received in the DV mode.

4 MENU SCREEN

■ Menu items and their details (Continued)

RX Position Display Timer (Display)

Sets the RX position data display time period.

Reply Position Display

Selects whether or not to display the caller's position data in a dialog when the data is included in the Auto Reply signal.

TX Call Sign

Selects whether or not to display My or Your call sign while transmitting.

Scroll Speed

Selects the scrolling speed of the message, call sign, or other text.

Opening Message

Selects whether or not to display the opening message at power ON.

Voltage (Power ON)

Selects whether or not to display the voltage of the external DC power source at power ON.

Display Unit

Set Display units options.

Latitude/Longitude

Selects position format to display the position.

Altitude/Distance

Selects the units to display the distance and altitude.

Speed

Selects the units to display the speed.

Temperature

Selects the units to display the temperature.

Barometric

Selects the units to display the barometric pressure.

Rainfall

Selects the units to display the rainfall.

Wind Speed

Selects the units to display the wind speed.

Display Language

Selects the display language in the DR screen or Menu screen.

When "English" is selected in "System Language," this setting will disappear.

System Language

Selects English or Japanese as the system language of the transceiver.

Sounds

Sets the Sound options.

Beep Level

Sets the beep output level.

Key-Touch Beep

Turns the confirmation beep tones when key is pushed, ON or OFF.

Home CH Beep

Turns the Home CH Beep ON or OFF.

Band Edge Beep

Turns the Band edge beep ON or OFF.

Scan Stop Beep

Turns the scan stop beep ON or OFF.

Standby Beep

Turns the standby beep function in the DV mode ON or OFF.

Scope AF Output

Selects the audio output option during a sweep.

Time Set

Sets the Time options.

Date/Time**DATE**

Sets the current date.

TIME

Sets the current time.

GPS Time Correct

Sets to automatically correct the time using a GPS signal.

UTC Offset

Enters the time difference between UTC and the local time.

Auto Power OFF

Turns the Auto power OFF function ON or OFF.

DV Gateway

Enters the Terminal mode or Access Point mode.

<<Terminal Mode>>

Enters the Terminal mode.

<<Access Point Mode>>

Enters the Access Point mode.

SD Card*

Sets the SD card options.

Load Setting**File selection**

Loads the settings file to the transceiver.

Save Setting**<<New File>>**

Saves the settings as a new file.

File selection

Saves the settings in a selected file.

Import/Export

Import or export the CSV format file.

Import

Selects to import the Your call sign, Repeater list, or GPS memory data in the CSV format file.

Export

Selects to export the Your call sign, Repeater list, or GPS memory data in the CSV format file.

CSV Format**Separator/Decimal**

Selects the separator and the decimal character for the CSV format.

Date

Selects the date format.

SD Card Info

Displays the free space and remaining recording time of the card.

Firmware Update

Enters the Firmware Update mode.

Format

Formats the card.

Unmount

Electronically unmounts the card.

*A microSD card is required.

4 MENU SCREEN

■ Menu items and their details (Continued)

Bluetooth Set*

Sets the Bluetooth® options.

Bluetooth

Turns the Bluetooth function ON or OFF.

Auto Connect

Selects whether or not to automatically connect to a paired Bluetooth device when the device is turned ON.

Pairing/Connect

Selects to pair or connect to a Bluetooth device.

Device Search

Search Headset

Searches for a Bluetooth headset.

Search Data Device

Searches for a Bluetooth data device.

Pairing list

Displays the paired device.

<<Pairing Reception>>

Accepts the connection request from a Bluetooth device.

Headset Set

AF Output

Selects the AF output option for when you use a Bluetooth headset.

Headset Function Select

Selects the PTT and microphone combination when either a Bluetooth headset or the radio microphone are used.

VOX

(Bluetooth Set > Headset Set)

VOX

Turns the VOX function ON or OFF when you use a Bluetooth headset.

VOX Level

Sets the MIC Gain level.

When the microphone input level is higher than this set value, the transceiver starts to transmit, and the input level is lower than this set value, it returns to receive.

VOX Delay

Sets the VOX Delay time for the transmitter stays ON after you stop speaking before the VOX switches to receive.

VOX Time-Out Timer

Sets the VOX Time-Out Timer to prevent an accidental prolonged transmission.

Icom Headset

Sets to use the optional Icom Bluetooth headset (VS-3).

Power Save

Sets the Power save function to prolong the headset battery.

One-Touch PTT

Sets the One-Touch PTT function to toggle between transmission and reception by pushing [PTT].

PTT Beep

Sets to sound a beep when you push [PTT].

Custom Key Beep

Sets to sound a beep when you push the custom key ([PLAY]/[FWD]/[RWD]).

*The optional UT-137 is required.

Custom Key (Bluetooth Set > Headset Set > Icom Headset)

Selects the key function of the custom key ([PLAY]/[FWD]/[RWD]).

Data Device Set

Sets the data device options.

Serialport Function

Selects to transmit or receive the CI-V command or the DV data.

Bluetooth Device Information

Displays the optional UT-137 Bluetooth UNIT information.

Initialize Bluetooth Device

Selects to reset the optional UT-137 Bluetooth UNIT.

Others

Sets other options.

Information**Voltage**

Displays the voltage of the external DC power source.

Version

Displays the transceiver's firmware version number.

Clone**Clone Mode**

Reads or writes the CS-4100 data from or to the PC.

Reset**Partial Reset**

Returns all settings to their defaults, without clearing the memory contents, call sign memories or repeater lists.

All Reset

Clears all programming and memories, and return all settings to their defaults.

■ Entering Memory channels

The transceiver has a total of 1000 Memory channels to save often-used frequencies.

In the Memory mode, you can quickly select the saved frequencies.

This section describes the basic channel content entry.

Example: Entering 146.030 MHz/FM mode into a blank channel.

Hold down [MW] for 1 second.

- The memory contents are briefly displayed, then the operating data is saved into a blank channel.

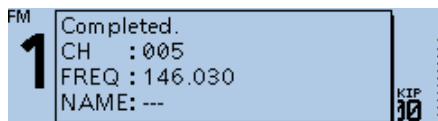

TIP: To enter content into the selected channel, see the Advanced manual for details. (Section 2)

■ Checking the Memory contents

You can check the Memory contents on the MEMORY LIST screen.

Example: Checking the contents of Memory channel 5.

Manage Memory > **Memory CH**

1. Push [MENU].
2. Rotate [DIAL] to select “Manage Memory,” then push [↵].
3. Select “Memory CH,” then push [↵].
 - Displays the MEMORY CH screen.
4. Select “ALL,” then push [↵].
 - Displays the ALL screen.
5. Select “005,” then push [↵].

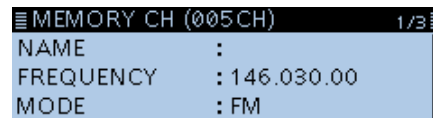

- Displays the data in Channel 5 on the MEMORY CH (005CH) screen.
 - ① You can select a page by rotating [DIAL].
6. Push [MENU].
 - Returns to the standby screen.

■ Selecting a Memory channel

In the Memory mode, you can select the Memory channels by rotating [DIAL].

1. Push [V/M] several times until you enter the Memory mode.



Displayed

- ① Pushing [V/M] toggles between the VFO and Memory modes.
2. Rotate [DIAL].
 - Selects a Memory channel.
 - ① Blank channels are not selected.

Scanning is a versatile function that can automatically search for signals. A scan makes it easier to locate stations to contact or listen to, or to skip unwanted channels or frequencies.

This section describes the basic scan operation.

■ VFO mode scan

1. Push [V/M] several times until you enter the VFO mode.
2. Hold down [SCAN] for 1 second.
 - Opens the Scan Type Select window.
 - ① If you hold down [SCAN] for 3 seconds, the last selected scan starts.
3. Rotate [DIAL] to select a scan type, then push [↵].
 - The scan starts.



- ① The decimal point and the selected scan type icon blink.
- ① When receiving a signal, the S-meter displays the received signal strength.
4. Push [SCAN].
 - Cancels the scan.

◇ Scan type

The VFO mode scan has 6 scan types.

- ALL: Full scan
- BAND: Band scan
- P-LINK0 ~ 9: Program link scan
- P00 ~ 24: Program scan
- DUP: Duplex scan
(Displayed only when duplex is set.)
- TONE: Tone scan
(For the Tone Squelch scanning)

- ① The frequencies that are set as a Skip channel (PSKIP) are skipped during a scan. (p. 44)
- ① When the “Program Skip” item is set to “OFF,” the Skip channel frequencies are not skipped. (p. 29)
(Scan > **Program Skip**)

TIP:

- During a scan, rotating [DIAL] switches the scanning direction.
- During a scan, you can change the operating band, scan edge, and so on, in the Quick Menu window.
- The scan continuously runs, even if you push [MENU] or [QUICK] during a scan.

◇ Setting the skip frequencies

You can set unnecessary frequencies as a Skip channel (PSKIP) to be skipped during a scan. The Skip function speeds up a scan.

1. Start the VFO scan.
 - When a signal is received, the scan pauses.
2. Push [QUICK].
3. Rotate [DIAL] to select “SKIP.”

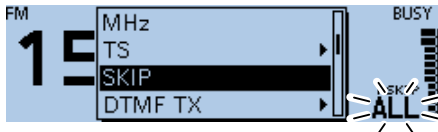

- Sets the frequency as a Skip channel into empty Memory channel 999.
 - The entered Memory channel number blinks.
 - ① If channel 999 already has content, the transceiver automatically searches for another blank channel to use. If there is no blank channel, an error beep sounds, and the frequency is not set as a Skip channel.
4. After setting, the scan resumes.

TIP: Once frequencies are set as a Skip channel, these frequencies are skipped until clearing the skip setting. To clear the skip setting, see page 46 for details.

① The skip setting is also cleared when the Memory channel set as a Skip channel is deleted. See the Advanced manual for details. (Section 1)

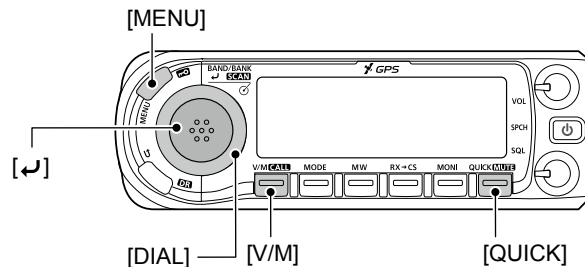

6 SCAN OPERATION

■ Memory scan

NOTE: Two or more memory channels, which are not set as Skip channels, must be entered to start a Memory scan.

1. Push [V/M] several times until you enter the Memory mode.
2. Hold down [SCAN] for 1 second.
 - Opens the Scan Type Select window.
 - ① If you hold down [SCAN] for 3 seconds, the last selected scan starts.
3. Rotate [DIAL] to select a scan type, then push [↵].
 - The scan starts.



- ① The decimal point and **MR** blink.
- ① When receiving a signal, the S-meter displays the received signal strength.
4. Push [SCAN].
 - Cancels the scan

◇ Scan type

The Memory mode scan has 5 scan types.

- ALL: Full scan
- BAND: Band Memory scan
- MODE: Mode Memory scan
- DUP: Duplex scan
(Displayed only when duplex is set.)
- TONE: Tone scan
(For the Tone squelch scanning)

- ① The channels that are set as a Skip channel (PSKIP or SKIP) are skipped during a scan. (p. 46)
- ① When two or more Memory channels, which are not set as Skip channels, are entered, the Memory scan is usable. See the Advanced manual for details. (Section 2)

TIP:

- During a scan, rotating [DIAL] switches the scanning direction.
- The scan continuously runs, even if you push [MENU] or [QUICK] during a scan.

■ Setting and clearing a Skip channel

You can set or clear a Skip channel setting.
The channels that are set as a Skip channel are skipped during a scan.

1. Push [V/M] several times until you enter the Memory mode.
2. Rotate [DIAL] to select the Memory channel.
3. Push [QUICK].
4. Rotate [DIAL] to select "SKIP," then push [↵].
5. Select the option, then push [↵].
 - OFF: Cancel the skip setting.
 - SKIP: Skipped during a memory scan.
 - PSKIP: Skipped during both VFO and memory scans.

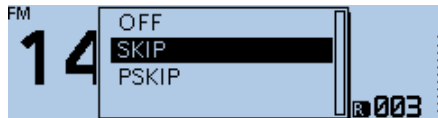

- When a Skip channel is set, "SKIP" or "PSKIP" is displayed.

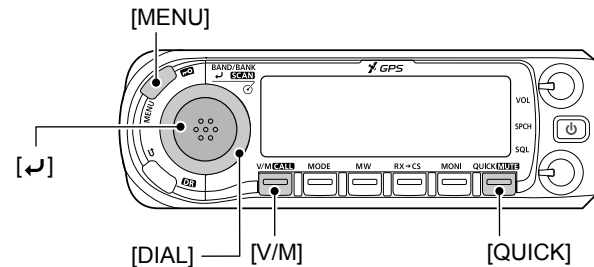

■ About the microSD card

NOTE: The microSD and microSDHC cards are not supplied. (user supplied)

A microSD card of up to 2 GB, or a microSDHC of up to 32 GB, can be used with the ID-4100A/E.

Icom has checked the compatibility with the following microSD and microSDHC cards.

(As of May 2017)

Brand	Type	Memory size
SanDisk®	microSD	2 GB
	microSDHC	4/8/16/32 GB

① Information

- The performance of the cards listed above is not guaranteed.
- Throughout the rest of this document, the microSD card and a microSDHC card are simply called microSD cards.
- Before using the microSD card, format all microSD cards to be used with the transceiver, even preformatted microSD cards for PCs or other uses. (p. 48)

TIP: Saving the factory default data is recommended. To save data, insert the card into the transceiver's slot, then select the "SD Card" item on the MENU screen. (SD Card > **Save Setting**)

NOTE:

- Before using the microSD card, read the instructions of the microSD card thoroughly.
- If you do any of the following, the microSD card data may be corrupted or deleted.
 - You remove the microSD card from the transceiver while accessing the microSD card.
 - You change the external power supply's voltage while accessing the microSD card.
 - You start the vehicle engine while accessing the microSD card.
- Do not touch the contacts of the microSD card.
- The transceiver takes a longer time to recognize a high capacity microSD card.
- The microSD card will get warm if used continuously for a long period of time.
- The microSD card has a certain lifetime, so data reading or writing may not be possible after using it for a long time period.
- When reading or writing data is impossible, the microSD card's lifetime has ended. In this case, purchase a new one. We recommend you make a backup file of the important data onto your PC.
- Icom will not be responsible for any damage caused by data corruption of a microSD card.

■ Inserting the microSD card

NOTE: Before inserting, be sure to check the card direction. If the card is forcibly or inversely inserted, it will damage the card and/or the slot.

1. Turn OFF the transceiver.
2. Insert the card into the slot until it locks in place, and makes a 'click' sound.
3. Turn ON the transceiver.
 - "■" is displayed when the microSD card is inserted.
 - ① While accessing the microSD card, "■" and "□" alternately blink.

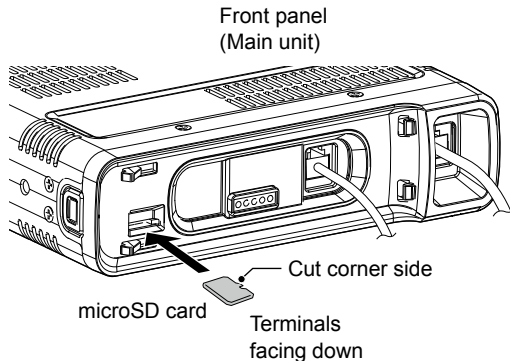

◇ Formatting the microSD card

Before using a microSD card, format it to be used with the transceiver by doing the following steps.

- ① Formatting a card erases all its data. Before formatting any used card, back up its data onto your PC.

SD Card > Format

1. Turn OFF the transceiver, then insert the card into the slot.
2. Turn ON the transceiver.
 - Displays "■."
3. Push [MENU].
4. Rotate [DIAL] to select "SD Card," then push [↵].
 - Displays the SD CARD screen.
5. Select "Format," then push [↵].
 - The confirmation dialog "Format OK?" is displayed.
6. Select <YES>, then push [↵].

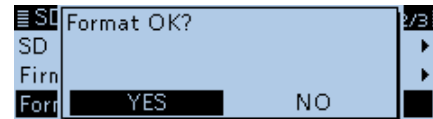

- The formatting starts and the display shows the formatting progress.
- ① After formatting ends, the display automatically returns to the screen displayed before the "Format OK?" window.

■ Removing the microSD card

NOTE: DO NOT remove the card from the transceiver while the card is being accessed. Otherwise, the card data may be corrupted or deleted.

◇ Removing the microSD card

1. Turn OFF the transceiver.
2. Push in the microSD card until a click sounds, and then carefully pull it out.

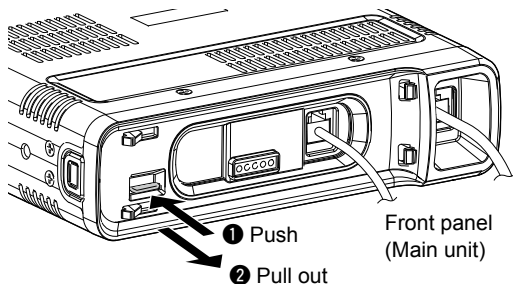

◇ Removing the microSD card while the transceiver's power is ON

SD Card > Unmount

1. Push [MENU].
2. Rotate [DIAL] to select "SD Card," then push [↵].
 - Displays the SD CARD screen.
3. Select "Unmount," then push [↵].
 - The confirmation dialog "Unmount OK?" is displayed.
4. Select <YES>, then push [↵].

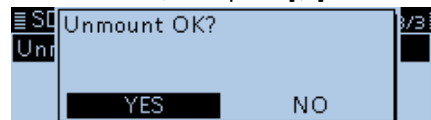

- When the unmounting is completed, "Unmount is completed." is briefly displayed, then the display automatically returns to the screen displayed before the "Unmount OK?" window.
5. Push in the microSD card until a click sounds, and then carefully pull it out.

■ Recording a QSO audio

NOTE: Once the voice recording starts, it will continue until you stop recording, even if you turn OFF the transceiver.

1. Push [QUICK].
 2. Rotate [DIAL] to select “<<REC Start>>,” then push [↵].
 - “Recording started” is briefly displayed, and voice recording starts.
- ① **Information**
- “🔴” is displayed while the transceiver is recording.
 - “⏸” is displayed while the recording is paused.
 - Recording is continuous until you manually stop recording, or the card becomes full.
 - If the recording file’s content reaches 2GB, the transceiver automatically creates a new file, and continues recording.
3. Push [QUICK].
 4. Select “<<REC Stop>>,” then push [↵].
 - “Recording stopped” is briefly displayed, and voice recording stops.

TIP: When the PTT Automatic Recording function is ON, the recording automatically starts when the transmission is started by pushing [PTT], the Bluetooth VOX function, or CI-V command.
(Voice Memo > QSO Recorder > Recorder Set > **PTT Auto REC**)

■ Playing recorded audio

Voice Memo > QSO Recorder > **Play Files**

1. Push [MENU].
2. Rotate [DIAL] to select “Voice Memo,” then push [↵].
 - Displays the VOICE MEMO screen
3. Select “QSO Recorder,” then push [↵].
 - Displays the QSO RECORDER screen.
4. Select “Play Files,” then push [↵].
 - Displays the PLAY FILES screen.
5. Select the folder that contains the file you want to play.
 - Displays the file list.
 - ① The folder is named yyyyymmdd (y: year, m: month, d: day.)
6. Select the file that you want to play.
 - Displays the VOICE PLAYER screen, and the file starts to play.

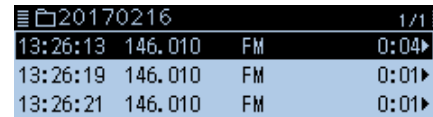

7. Push [MW].
 - Stops the playing.

NOTE: The built-in GPS receiver cannot calculate its position if it cannot receive signals from the GPS satellites. Refer to page vii for details.

■ GPS operation

The transceiver has a built-in GPS receiver. You can check your current position, and transmit GPS data in the DV mode.

See the Advanced manual for details. (Section 5)

◇ Confirming the GPS signal receiving

Confirm the GPS receiver is receiving your position.

The GPS icon blinks when searching for satellites.



The GPS icon stops blinking when the minimum needed number of satellites is found.



- ① It may take only a few seconds to receive, or it may take a few minutes, depending on your operating environment. If you have difficulties receiving, we recommend that you try a different location.
- ① When the "GPS Select" item is set to "Manual," the icon does not appear.
(GPS > GPS Set > **GPS Select**)

■ Checking your GPS position

You can check your current position.

If you transmit while displaying the GPS position screen, the screen closes.

To check your current position or RX position while transmitting, push [QUICK], then select "GPS Position" while transmitting.

◇ Displaying Position Data

1. Push [QUICK].
2. Select "GPS Position," then push [↵].

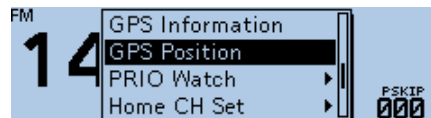

- Displays the GPS POSITION screen.

3. Rotate [DIAL].
 • Selects the page.

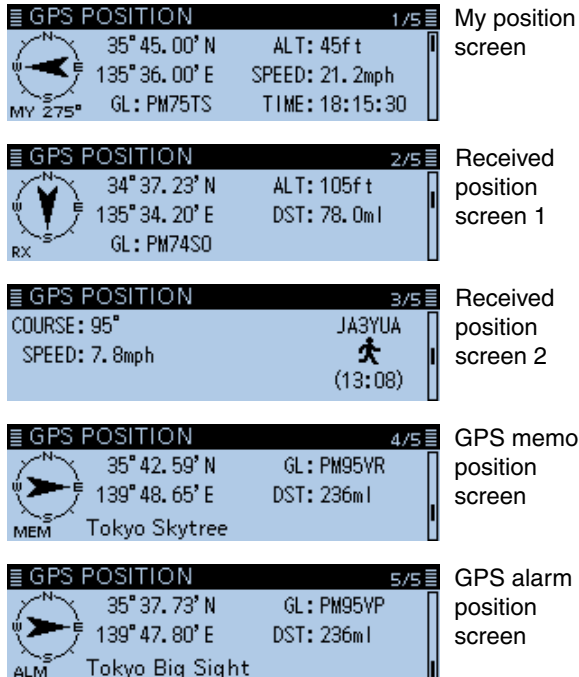

(Example)

4. Push [5].
 • Returns to the standby screen.

About the GPS POSITION screen

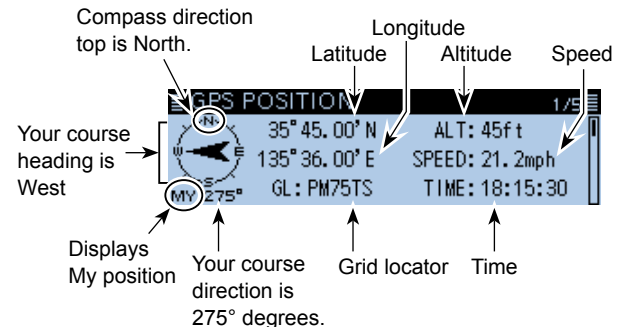

GPS POSITION screen (MY)

■ Resetting

Occasionally, erroneous information will be displayed when, for example, first applying power. This may be caused externally by static electricity or by other factors. If this problem occurs, turn OFF the transceiver. After waiting a few seconds, turn ON the transceiver again. If the problem is still there, perform a Partial reset or an All reset.

A Partial reset resets the operating settings to their default values (VFO frequency, VFO settings, menu contents) without clearing data as listed below:

Memory channel contents	Scan Edge contents
Call channel contents	Call sign memories
Message data	DTMF memory contents
GPS Memory contents	Repeater list

BE CAREFUL! An All reset clears all programming and returns all settings to their factory defaults. After All Resetting, you cannot use the DR function because the Repeater List contents are also cleared. See the Advanced manual for details. (Section 10)

◇ Partial Reset

Others > Reset > **Partial Reset**

1. Push [MENU].
2. Rotate [DIAL] to select “Others,” then push [↵].
• Displays the OTHERS screen.
3. Select “Reset,” then push [↵].
• Displays the RESET screen.
4. Select “Partial Reset,” then push [↵].
• The confirmation dialog “Partial Reset?” is displayed.
5. Select <YES>, then push [↵].

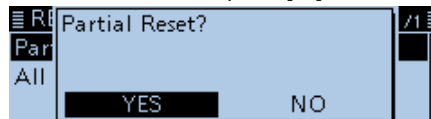

- When the partial reset is completed, “PARTIAL RESET” is displayed, then the display automatically returns to the default screen.

■ Fuse replacement

A fuse is installed in each fuse holder of the supplied DC power cable. If a fuse blows, or the transceiver stops functioning, track down the source of the problem if possible, repair it and then replace the damaged fuse with a new rated one (FGB 15 A).

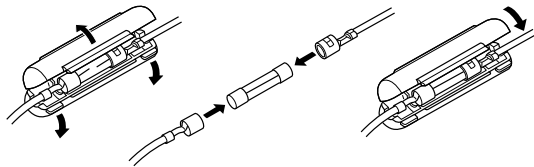

⚠ WARNING!

- **NEVER** remove the fuse holders from the DC power cable. **USE** only the applicable fuses.
- **NEVER** replace the fuse when the DC cable is connected to the power supply.

■ Power protect function

The transceiver is equipped with a protection circuit for the power amplifier. The circuit activates when the transceiver continuously transmit at high power, and then the temperature becomes extremely high.

In this case, the transceiver automatically reduces transmit output power to low (approximately 5 W).

When the Power Protect function activates, wait until the transceiver's temperature returns to normal.

NOTE: When the power supply voltage is high, the transceiver automatically displays "Over Voltage," and then sounds a warning beep. In this case, the transceiver may be damaged. In that case, contact your nearest Icom Dealer or Service Center.

■ Troubleshooting

The following chart is designed to help you correct problems which are not equipment malfunctions.

If you are unable to locate the cause of a problem, or solve it through the use of this chart, contact your nearest Icom Dealer or Service Center.

PROBLEM	POSSIBLE CAUSE	SOLUTION	REF.
Transceiver does not turn ON.	<ul style="list-style-type: none"> • The power cable is improperly connected. • A fuse is blown. 	<ul style="list-style-type: none"> • Reconnect the DC power cable correctly. • Correct the cause, then replace the fuse with an equivalent fuse. (Fuses are installed in the DC power cable.) 	<p>– p. 54</p>
No sound comes from the speaker.	<ul style="list-style-type: none"> • Power source voltage is not correct. 	<ul style="list-style-type: none"> • Apply the correct 13.8 V DC. 	–
No sound comes from the speaker.	<ul style="list-style-type: none"> • The audio volume level is too low. 	<ul style="list-style-type: none"> • Rotate [VOL] clockwise to obtain a suitable listening level. 	p. 19
	<ul style="list-style-type: none"> • The squelch is tightly closed. 	<ul style="list-style-type: none"> • Rotate [SQL] to the proper level to open the squelch. 	p. 19
Sensitivity is too low, and only strong signals are audible.	<ul style="list-style-type: none"> • The tone squelch is ON in the FM mode. 	<ul style="list-style-type: none"> • Turn OFF the Tone squelch. 	p. 20
	<ul style="list-style-type: none"> • The external speaker is not connected. 	<ul style="list-style-type: none"> • Reconnect the external speaker. 	p. 15
	<ul style="list-style-type: none"> • The audio is muted. 	<ul style="list-style-type: none"> • Hold down [MUTE] to release mute. 	p. 10
Sensitivity is too low, and only strong signals are audible.	<ul style="list-style-type: none"> • The antenna is defective or the coaxial cable connector is shorted or cut. 	<ul style="list-style-type: none"> • Correct the cause, then reconnect to the antenna connector. 	–
	<ul style="list-style-type: none"> • The Attenuator function is turned ON. 	<ul style="list-style-type: none"> • Turn OFF the attenuator. 	p. 35
	<ul style="list-style-type: none"> • The squelch is set too tight. 	<ul style="list-style-type: none"> • Rotate [SQL] to adjust the squelch level. 	p. 19

PROBLEM	POSSIBLE CAUSE	SOLUTION	REF.
Transmitting is impossible, or the transmit power level is low.	<ul style="list-style-type: none"> • Duplex function are ON, and the transmit and receive frequencies are different. • The transmit power level is set to LOW or MID. • The PTT Lock function is activated. • The Busy Lockout function is activated. 	<ul style="list-style-type: none"> • Turn OFF the Duplex function. • Set the transmit power level to HIGH. • Turn OFF the PTT Lock function. • Turn OFF the Busy Lockout function. 	AM sec. 8 p. 26 p. 35 p. 35
The displayed frequency is erroneous.	<ul style="list-style-type: none"> • The CPU has malfunctioned. • External factors have caused the fault. 	<ul style="list-style-type: none"> • Reset the transceiver. • Disconnect and connect to the DC power supply. 	p. 53 –
Frequency cannot be set.	<ul style="list-style-type: none"> • The Lock function is activated. • The VFO mode is not selected. 	<ul style="list-style-type: none"> • Hold down [LOCK] for 1 second to turn OFF the Lock function. • Push [V/M] to select the VFO mode. 	p. 24 p. 21
A Program Scan does not start.	<ul style="list-style-type: none"> • The VFO mode is not selected. • The same frequencies are entered into the scan edges. 	<ul style="list-style-type: none"> • Push [V/M] to select the VFO mode. • Enter different frequencies into the scan edges. 	p. 21 AM sec. 2
A Memory Scan does not start.	<ul style="list-style-type: none"> • The Memory mode is not selected. • Only one or no memory channel has been programmed. 	<ul style="list-style-type: none"> • Push [V/M] to select the Memory mode. • Program two or more memory channels. 	p. 21 p. 41
During tone squelch operation, the received audio breaks off at the other station.	<ul style="list-style-type: none"> • Transmitter's microphone gain is too high. 	<ul style="list-style-type: none"> • Set the microphone sensitivity to low. 	p. 35
Transmission is automatically cut off.	<ul style="list-style-type: none"> • The Time-out timer function is activated. 	<ul style="list-style-type: none"> • Turn OFF the Time-out timer function. 	p. 35

*"AM" indicates the Advanced manual.

10 SPECIFICATIONS

◇ General

- Frequency coverage:
 - EUR Receive
 - 118 ~ 174 MHz (Guaranteed only 144 ~ 146 MHz)
 - 230 ~ 550 MHz (Guaranteed only 430 ~ 440 MHz)
 - Transmit
 - 144 ~ 146 MHz, 430 ~ 440 MHz
 - ITR Receive
 - 118 ~ 136.99166 MHz (Not guaranteed),
 - 144 ~ 146 MHz, 430 ~ 434 MHz, 435 ~ 438 MHz
 - Transmit
 - 144 ~ 146 MHz, 430 ~ 434 MHz,
 - 435 ~ 438 MHz
 - USA Receive
 - 118 ~ 174 MHz (Guaranteed only 144 ~ 148 MHz)
 - 230 ~ 550 MHz (Guaranteed only 430 ~ 450 MHz)
 - Transmit
 - 144 ~ 148 MHz, 430 ~ 450 MHz
 - EXP Receive
 - 118 ~ 174 MHz (Guaranteed only 144 ~ 148 MHz)
 - 230 ~ 550 MHz (Guaranteed only 430 ~ 440 MHz)
 - Transmit
 - 137 ~ 174 MHz (Guaranteed only 144 ~ 148 MHz)
 - 400 ~ 470 MHz (Guaranteed only 430 ~ 440 MHz)
- Mode:
 - F2D/F3E (FM/FM-N), F7W (DV),
 - A3E (AM/AM-N) RX only
- No. of memory channels: 1000 channels
- No. of program scan channels:
 - 50 channels
 - (2 channels × 25 pairs)
- No. of call channels:
 - 4 channels
 - (2 channels × 2 bands)
- No. of repeater lists: 1500
- No. of GPS memory: 300
- Antenna impedance: 50 Ω (SO-239)
- Usable temperature range:
 - 10°C to +60°C
 - (+14°F to +140°F)
- Frequency stability:
 - ±2.5 ppm (-10°C to +60°C, +14°F
 - to +140°F) at +25°C (+77°F)
- Digital transmission speed: 4.8 kbps
- Voice coding speed: 2.4 kbps
- Frequency resolution:
 - 5 kHz, 6.25 kHz, 8.33 kHz*,
 - 10 kHz, 12.5 kHz, 15 kHz,
 - 20 kHz, 25 kHz, 30 kHz, and
 - 50 kHz
- *Selectable depending on the operating band or mode.
- Power supply:
 - 13.8 V DC ±15%
 - (negative ground)
- Current drain:
 - Transmit
 - Maximum current drain:
 - ≤ 13.0 A (at High)
 - ≤ 7.5 A (at Mid)
 - ≤ 5.0 A (at Low)
 - Receive
 - Standby:
 - ≤ 0.9 A
 - ≤ 1.2 A
 - Maximum audio:
 - ≤ 1.2 A
- Dimensions:
 - 150(W) × 40(H) × 171.9(D) mm
 - 5.9(W) × 1.6(H) × 6.8(D) inch
 - (projections are not included)
- Weight (approximate):
 - 1.2 kg, 2.6 lb
 - (microphone, cable, and bracket are not included)

◇ **Transmitter**

- Modulation system:
 - FM/FM-N Variable reactance frequency modulation
 - DV GMSK reactance frequency modulation
- Max Deviation:
 - FM $\leq \pm 5.0$ kHz
 - FM-N $\leq \pm 2.5$ kHz
- Occupied bandwidth:
 - ≤ 16.0 kHz (FM)
 - ≤ 8.0 kHz (FM-N)
 - ≤ 6.0 kHz (DV)
- Microphone impedance: 600 Ω
- Spurious emission: ≤ -60 dBc
- Output power: High 50 W, Mid 15 W, Low 5 W

◇ **Receiver**

- Receive system: Double Conversion Superheterodyne system
- IF frequencies:
 - 1st IF 46.35 MHz
 - 2nd IF 450 kHz
- Sensitivity (except spurious points)
 - Amateur bands
 - FM/FM-N (12 dB SINAD) ≤ 0.18 μ V
 - DV (BER 1%) ≤ 0.22 μ V

Except Amateur bands

FM/FM-N (12 dB SINAD)

- ≤ 0.32 μ V (137.000 to 159.995 MHz)
- ≤ 0.32 μ V (160.000 to 174.000 MHz)
- ≤ 1.8 μ V (230.000 to 259.995 MHz)
- ≤ 0.56 μ V (260.000 to 321.995 MHz)
- ≤ 0.56 μ V (322.000 to 374.995 MHz)
- ≤ 0.56 μ V (375.000 to 399.995 MHz)
- ≤ 0.32 μ V (400.000 to 499.995 MHz)
- ≤ 0.56 μ V (500.000 to 550.000 MHz)

AM/AM-N* (10 dB S/N)

- ≤ 1 μ V (118.000 to 136.991 MHz)
- ≤ 5.6 μ V (230.000 to 259.995 MHz)
- ≤ 1.8 μ V (260.000 to 321.995 MHz)
- ≤ 1.8 μ V (322.000 to 374.995 MHz)

*The ID-4100A/E can receive the AM-N mode in only the 118.000 to 136.991 MHz band.

- Squelch sensitivity: ≤ 0.13 μ V (Threshold)
- Selectivity:
 - FM ≥ 60 dB
 - FM-N ≥ 55 dB
 - DV ≥ 50 dB
- Spurious and image rejection ratio: ≥ 60 dB
- AF output power: ≥ 2.0 W (at 10% distortion with an 8 Ω load)
- AF output impedance: 8 Ω

■ About CE and DOC



Hereby, Icom Inc. declares that the versions of ID-4100E which have the “CE” symbol on the product, comply with the essential requirements of the Radio Equipment Directive, 2014/53/EU, and the restriction of the use of certain hazardous substances in electrical and electronic equipment Directive, 2011/65/EU. The full text of the EU declaration of conformity is available at the following internet address:
<http://www.icom.co.jp/world/support>

■ Disposal



The crossed-out wheeled-bin symbol on your product, literature, or packaging reminds you that in the European Union, all electrical and electronic products, batteries, and accumulators (rechargeable batteries) must be taken to designated collection locations at the end of their working life. Do not dispose of these products as unsorted municipal waste. Dispose of them according to the laws in your area.

■ FCC information

This equipment has been tested and found to comply with the limits for a Class B digital device, pursuant to part 15 of the FCC Rules. These limits are designed to provide reasonable protection against harmful interference in a residential installation. This equipment generates, uses and can radiate radio frequency energy and, if not installed and used in accordance with the instructions, may cause harmful interference to radio communications. However, there is no guarantee that interference will not occur in a particular installation. If this equipment does cause harmful interference to radio or television reception, which can be determined by turning the equipment off and on, the user is encouraged to try to correct the interference by one or more of the following measures:

- Reorient or relocate the receiving antenna.
- Increase the separation between the equipment and receiver.
- Connect the equipment into an outlet on a circuit different from that to which the receiver is connected.
- Consult the dealer or an experienced radio/TV technician for help.

CAUTION: Changes or modifications to this device, not expressly approved by Icom Inc., could void your authority to operate this device under FCC regulations.

INDEX

A		G	
Accessories	i	GPS operation	51
Antenna		Checking your GPS position	51
Installing	5	Confirming the GPS signal receiving.....	51
Internal duplexer.....	5		
Audio volume level setting.....	19	H	
		Home Channel function.....	25
C		I	
Call channel mode selecting.....	21	Installation	1
Connection	1	Antenna	5
Battery	6	In a vehicle	4
DC power supply	3	UT-137	7
Microphone.....	3		
Controller		L	
Attaching	1, 3	Lock function	24
Connecting to the main unit.....	1		
Detaching	1	M	
Display.....	11	Main unit	
Front panel	9	Front panel	14
Installing into your vehicle	2	Rear panel.....	15
		Memory channel	
D		Entering	41
DR function.....	24	Selecting.....	42
		Memory contents checking.....	41
E		Memory mode selecting	21
Electromagnetic Interference.....	8	Memory scan	45
		Scan type	45
F		MENU screen	27
Frequency setting	23	Menu item details	28
Selecting a tuning step.....	23	Menu item list	63
Selecting the 1 MHz tuning	23	Menu item selecting	27
Fuse replacement.....	54		

Microphone (HM-207S)	16
Connecting	3
Microphone connector information	14
microSD card	47
Formatting	48
Inserting	48
Removing	49
Unmounting	49
Monitor function	19
O	
Operating mode selecting	22
Operating band selecting	22
Options	iii
P	
Power	
Turning ON the power	19
Power protect function	54
Q	
Quick Menu window	20
R	
Recording audio	
Recording a QSO audio	50
Playing recorded audio	50
Resetting	53

S	
Scan operation	43
Memory scan	45
Setting and clearing a Skip channel	46
Setting the skip frequencies	44
VFO mode scan	43
Specifications	57
Speech function	25
Squelch level setting	19
T	
Transmitting	26
Troubleshooting	55
Turning ON the transceiver	19
V	
VFO mode scan	43
Scan type	43
VFO mode selecting	21
W	
Weather channel mode selecting	21

MENU ITEM LIST

The first tree level of each Menu category are listed below.

DUP/TONE...	Offset Freq
	Repeater Tone
	TSQL Freq
	Tone Burst
	DTCS Code
	DTCS Polarity
	Digital Code
Manage Memory	Memory CH
	Call CH
Scan	Pause Timer
	Resume Timer
	Temporary Skip Timer
	Program Skip
	Bank Link
	Program Scan Edge
	Program Link
Voice Memo	QSO Recorder
	DV Auto Reply
Voice TX	Record
	TX Set
	<<TX>>
GPS	GPS Set
	GPS TX Mode
	GPS Information
	GPS Position
	GPS Memory
	GPS Alarm
	GPS Logger
	GPS Auto TX
	Call Sign
RX History	—

DV Memory	Your Call Sign
	Repeater List
My Station	My Call Sign
	TX Message
DV Set	Tone Control
	Auto Reply
	DV Data TX
	DV Fast Data
	Digital Monitor
	Digital Repeater Set
	DV Auto Detect
	RX Record (RPT)
	BK
	EMR
EMR AF Level	
SPEECH	RX Call Sign SPEECH
	RX>CS SPEECH
	DIAL SPEECH
	MODE SPEECH
	SPEECH Language
	Alphabet
	SPEECH Speed
SPEECH Level	
DTMF	DTMF Memory
	DTMF Speed
QSO/RX Log	QSO Log
	RX History Log
	CSV Format

MENU ITEM LIST

Function	Squelch/ATT Select	
	Squelch Delay	
	Fan Control	
	Dial Speed-UP	
	Auto Repeater	
	Remote MIC Key	
	Up/Down MIC Key	
	One-Touch PTT(Remote MIC)	
	PTT Lock	
	Busy Lockout	
	Time-Out Timer	
	Active Band	
	MIC Gain	
	Data Speed	
	CI-V	
	Power OFF (With No Controller)	
	Display	LCD Backlight Brightness
		LCD Backlight Color
		Key Backlight Brightness
		Key Backlight Color
Backlight Night Time Setting		
Auto Dimmer Setting		
LCD Contrast		
RX Call Sign		
RX Position Indicator		
RX Position Display		
RX Position Display Timer		
Reply Position Display		
TX Call Sign		
Scroll Speed		
Opening Message		
Voltage (Power ON)		
Display Unit		
Display Language		
System Language		

Sounds	Beep Level
	Key-Touch Beep
	Home CH Beep
	Band Edge Beep
	Scan Stop Beep
	Standby Beep
	Scope AF Output
Time Set	Date/Time
	GPS Time Correct
	UTC Offset
	Auto Power OFF
DV Gateway	<<Terminal Mode>>
	<<Access Point Mode>>
SD Card	Load Setting
	Save Setting
	Import/Export
	SD Card Info
	Firmware Update
	Format
	Unmount
Bluetooth Set	Bluetooth
	Auto Connect
	Pairing/Connect
	<<Pairing Reception>>
	Headset Set
	Data Device Set
	Bluetooth Device Information
Initialize Bluetooth Device	
Others	Information
	Clone
	Reset

Count on us!

A7367D-1EX-2
Printed in Japan
© 2017–2018 Icom Inc.

Icom Inc.
1-1-32 Kamiminami, Hirano-ku, Osaka 547-0003, Japan