

KENWOOD

144/440/1200 MHz FM TRIBANDER

TM-941A

INSTRUCTION MANUAL

KENWOOD CORPORATION

©PRINTED IN JAPAN B62-0010-00(K,M,P,E) (A,T)

91/12 11 10 9 8 7 6 5 4 3 2 1 90/12 11 10 9 8

CONTENTS

1.	BEFORE OPERATION	4	4-6	REPEATER OPERATION	36
2.	SPECIFICATIONS and ACCESSORIES	5		Transmitter Offset Reverse Function	
3.	INSTALLATION INSTRUCTIONS	7		Tone and CTCSS Operation	
4.	OPERATION	10		Autopatch Operations	
4-1	OPERATING CONTROLS	10	4-7	DTSS	38
	Front Panel Display Panel			DTSS Code DTSS Code Selection	
	Rear Panel and Side case Microphone			Using the DTSS Function	
4-2	RECEIVER OPERATION	18		Using DTSS with a Repeater	
	Receiver Operation Frequency Selection		4-8	PAGING	40
	Frequency Step Selection			Paging Code Memories Code Selection	
	A.B.C.(Automatic Band Change)			Code Transmission	
	ALT (Automatic Lock Tuning)			Paging Code Monitoring	
4-3	TRANSMITTER OPERATION	22		Code Lockout	
	Transmission Band On/Off TX Alert		4-9	TONE ALERT SYSTEM	45
	Time-Out Timer (TOT)		4-10	AUTOMATIC POWER OFF	46
4-4	MEMORY	25	4-11	DIMMER	46
	Microprocessor Memory Back-up		4-12	BEEP	46
	Microprocessor Initialization Memory Channel		4-13	LOCK/A. LOCK	47
	Memory Contents Memory Entry				
	Memory Channel Recall Memory Bank		5.	BLOCK DIAGRAM and SCHEMATIC DIAGRAM	
	Clearing Memory Memory Shift		 another sheet	
4-5	SCAN	31	6.	MAINTENANCE	48
	Scan Options Hold/Resume Programming			In Case of Difficulty	
	Band Scan Programmable Band Scan		7.	OPTIONAL ACCESSORIES	51
	Memory Channel Scan CALL Scan			CTCSS unit (TSU-7)	
	Automatic Memory Scan			DTMF unit (DTU-2)	
	Memory Channel Lockout			Panel Separate Kit (PG-4K, PG-4L)	

1. BEFORE OPERATION

TO PREVENT ELECTRIC SHOCK, FIRE AND OTHER INJURY, PLEASE NOTE THE FOLLOWING:

Never remove the case unless instructed to do in this Instruction Manual. If the internal parts are touched accidentally, a serious electric shock might occur.

Do not place this unit, where it will be exposed to direct sunlight or close to heating appliances.

Do not place anything on top of the cabinet.

To ensure good ventilation, do not put anything on top of the cabinet and allow at least 15 cm (6 inches) of space behind the unit.

The power requirement is 13.8 VDC.
Never attempt connection to a 24 VDC source.

Do not place the unit in areas of excessive dust, high humidity or on unstable surfaces.

Do not drop pieces of metal, needles, coins and other electrically conductive materials into the unit.

Do not touch the power plug, when your hands are wet.

Do not pull the power cord, when disconnecting it from the AC wall outlet. Grasp the plug and ensure that your fingers do not touch the live pins.

If an abnormal odor or smoke is detected, immediately turn the power off. Contact the KENWOOD service station or your dealer.

CLEANING

1. Turn the power off, before cleaning the unit.
2. Do not use any type of abrasive pad, thinner, benzine or any substances which may damage the unit.
3. Wipe the front panel and other exterior surfaces of the unit with a soft dry cloth or a soft cloth lightly moistened with water.

FCC WARNING

This equipment may generate or use radio frequency energy. Changes or modifications to this equipment may cause harmful interference unless the modifications are expressly approved in the instruction manual. The user could lose the authority to operate this equipment if an unauthorized change or modification is made.

2. SPECIFICATIONS and ACCESSORIES

		144 MHz Band	440 MHz Band	1200 MHz Band	
GENERAL	Frequency range MHz	144 ~148	438 ~450	1240 ~ 1300	
	Mode	F3E(FM)			
	Antenna impedance	50Ω			
	Operating temperature	-20°C~+60°C(-4°F ~ +140°F)			
	Power requirements	13.8VDC ± 15 %(11.7 ~ 15.8V)			
	Ground	Negative			
	Current drain	Transmit mode	Less than 11.5A	Less than 10.0A	Less than 6.0A
		Receiver mode	Less than 1.2A	Less than 1.2A	Less than 1.2A
	Frequency stability	± 10ppm			
	Dimensions (W×H×D)	150 × 50 × 175 mm			
Weight	1.9kg				
TRANSMITTER	Output power	HI	50W	35W	10W
		MID	10W	10W	-
		LOW	Approx. 5W	Approx.5W	1W
	Modulation	Reactance modulation			
	Spurious radiation	Less than -60dB		Less than -50dB	
	Maximum frequency deviation	± 5kHz			
	Audio distortion (at 60% modulation)	Less than 3%			
	Microphone impedance	600Ω			

		144 MHz Band	440 MHz Band	1200 MHz Band
R	Circuitry	Double conversion superheterodyne		
	Intermediate frequency 1st/2nd	10.7 MHz/455 kHz	21.6 MHz/455 kHz	59.7 MHz/455 kHz
C	Sensitivity (12 dB SINAD)	Less than 0.16 μ V (-10 dB μ) ※		
E	Selectivity -6 dB	More than 12 kHz		
I	Selectivity -60 dB	Less than 24 kHz		Less than 36 kHz
V	Squelch sensitivity	Less than 0.1 μ V (-14 dB μ)		
E	Output (5% distortion)	More than 2 W (8 Ω load) \geq 5% distortion)		
R	External speaker impedance	8 Ω		

※ 1240 MHz to 1260 MHz: Less than 0.22 μ V (-7dB μ)

NOTE: 1. Circuit and ratings are subject to change without notice, due to developments in technology.

2. Recommended duty cycle: 1 minute Transmission, 3 minutes Reception.

2-2. ACCESSORIES

Unpack your transceiver carefully and confirm that the accessories listed below are included in the box.

DTMF Microphone	T91-0397-XX	1
(U.S.A. and Canada only)				
or				
Microphone	T91-0396-XX	1
Microphone Hook	J20-0319-XX	1
(U.S.A. and Canada only)				
Mobile Mounting Kit	1
Bracket	J29-0454-XX		
Screw set	N99-0331-XX		

Self tapping Screw	N46-3010-46	2
(U.S.A. and Canada only)				
Hex Wrench	W01-0414-XX	1
DC power Cable	E30-3034-XX	1
Fuse (15A)	F05-1531-XX	1
Instruction Manual	B62-0010-XX	1 copy	
Warranty Card			1
(U.S.A. and Canada only)				

After unpacking

Shipping container: Save the boxes and packing in the event your unit needs to be transported for remote operation, maintenance, or service.

3. INSTALLATION INSTRUCTIONS

3-1. INSTALLATION

3-1-1. Installing the Microphone

1. Slide the release button on the front panel to the right. Pull the front panel toward you from the right, then remove the whole panel unit. Be careful with the cord connecting the front panel unit to the chassis. (Fig. 1)

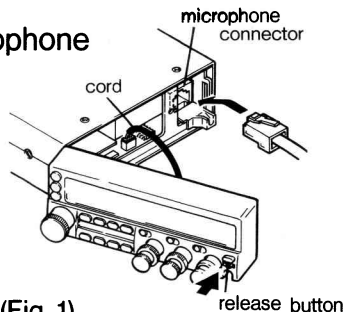

(Fig. 1)

2. Insert the microphone connector into the microphone socket on the right of the main unit until it clicks. Make sure the tab on the connector is on top.
3. Place the microphone cord in the holder groove. (Fig. 2)
4. Align the hook on the back of the front panel with the slot on the left of the chassis before putting the front panel back. (Fig. 2)

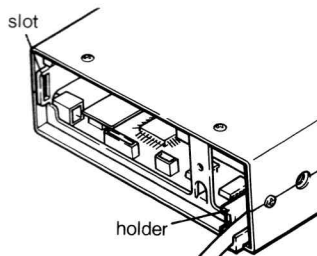

(Fig. 2)

5. Push the front panel toward the chassis until they lock completely, taking care not to trap the connecting cord.(Fig. 3)

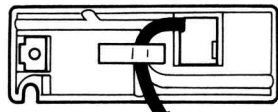

(Fig. 3)

The connecting cord is easier to manage when it is put in the groove on the back of the front panel.(Fig. 3)

3-1-2. Mounting Bracket

NOTES

1. When installing the transceiver in a vehicle consider ease of operation and safety when selecting the location for the mounting bracket.
2. Install the bracket securely so that it will not come off because of vibration.

1. Install the bracket using the supplied flat washers and self tapping screws (4 pcs. each).
2. Attach the transceiver loosely using the SEMS screws (4 pcs.).

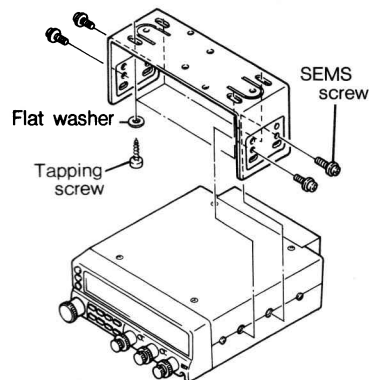

3. Adjust the viewing angle of the bracket to the desired position .



4. Hold the transceiver in place and tighten the 4 SEMS screws using the supplied wrench.

3-2. CONNECTION

3-2-1. Antenna

The type of antenna that is used will greatly affect the performance of the transceiver. Use a properly adjusted antenna, of good quality, to enable your transceiver to perform at its best. The antenna input impedance is 50 ohms. Use 50-ohm coaxial cable such as RG-8U or 8D-2V for this connection. If the antenna is far from the transceiver the use of low loss coaxial cable, such as RG-8U is recommended. Match the impedance of the coaxial cable and that of the antenna so that the SWR is less than 1.5 to 1. The protection circuit in the transceiver will activate if the SWR is particularly poor (greater than 3 to 1).

High SWR values will cause the transmitter output to drop, and may lead to TVI or BCI reports.

Caution :

We recommend that you install a high quality lightning arrester in your antenna lines for protection against fire, electric shock, personal injury, or damage to the radio itself.

3-2-2. Mobile Installations

Cautions :

1. Before installing the power cable, be sure to remove the negative lead from the battery for safety.
2. After installation and wiring, be sure to double check for correct installation before reconnecting the negative lead to the battery terminal.
3. If the fuse opens, be sure to check that each conductor has not been damaged by short circuiting, etc. Then replace with a new fuse of the same rating.

4. After completing the wiring, wrap the fuse holder with heat resistant tape to protect against heat and moisture.
5. Do not remove the fuse even if the power cable is too long.

Battery Connections

Connect the power cable directly to the battery terminals. Use of the cigarette lighter socket will lead to poor connection, and will result in poor performance. Pay close attention to the polarity of the cables when connecting them to the battery.

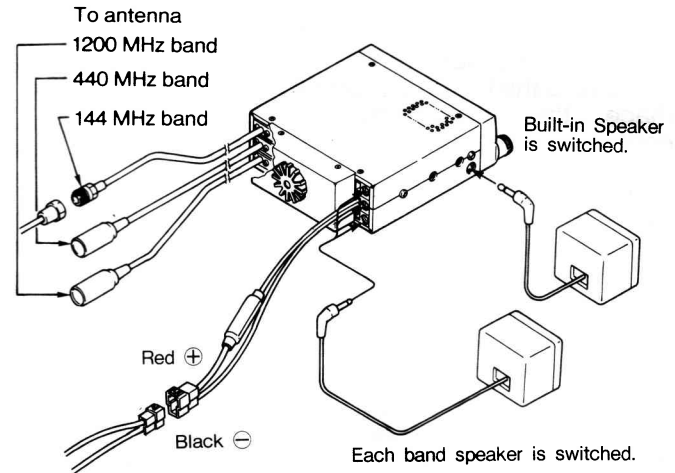

Caution :

Leave enough space around the fan on the rear panel for good ventilation.

Make sure the positive (+) and negative (-) lead polarity is correct when connecting to the battery.

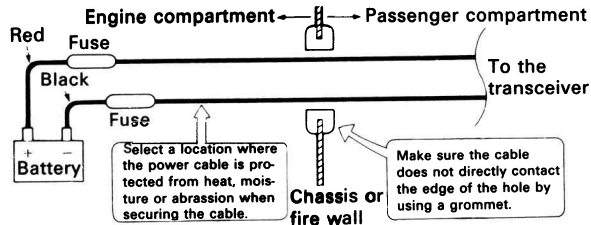

- If the wiring hole in the fire wall or chassis is too small, disassemble the fuse holder to thread the wire through the hole.

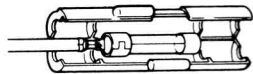

From passenger compartment
Thread like this

3-2-3. Fixed Station

A regulated DC power supply (13.8 VDC capable of supplying at least 12 Amperes) is required. The PS-430 and the PS-50 are recommended.

Caution :

1. Never connect the AC power cable to the AC outlet until all other connections have been made.
2. Before connecting and disconnecting the power connector, be sure to turn OFF the POWER switches of both the transceiver and the DC power supply.

3. Observe polarity of the DC power cable. The transceiver operates on 13.8 VDC, negative ground. Battery polarity must be correct. The power cable is color coded :

Red → + (Positive polarity)
Black → - (Negative polarity)

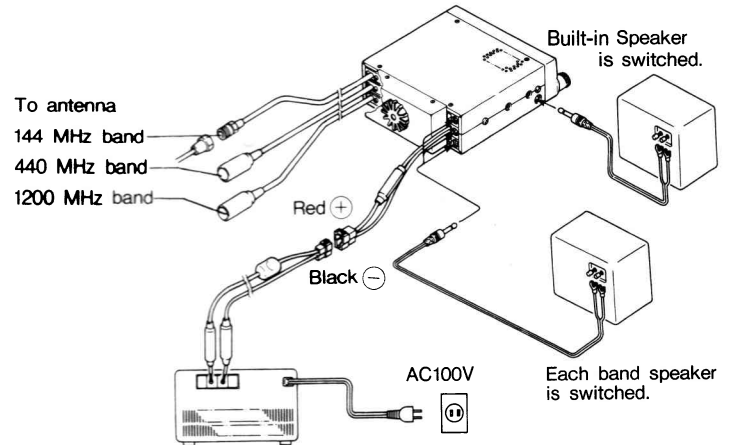

Caution :

Leave enough space around the fan on the rear panel for good ventilation.

4. OPERATION

4-1. OPERATING CONTROLS

4-1-1. Front Panel

Press the F key so that the indicators below the key (M▷V.M, or LOCK) begin to light red.

MR / M key

This key is used to select the MR (Memory Recall) mode from the VFO mode or CALL channel mode. The tuning control can then be used to select the desired Memory channel. Pressing the key for longer than 1 second will initiate memory channel scanning. Pressing the key within 10 seconds of pressing the F key will store the displayed data into memory.

MHz / LOCK key

This key is used to tell the microprocessor that you wish to increase or decrease the operating frequency in 1 MHz increments. Pressing this key within 10 seconds of pressing the F key will cause the key lock function to activate, protecting the currently displayed data from accidental erasure.

VFO / M▷V key

This key is used to return to the VFO mode after operating in the MR or CALL channel mode. Pressing this key will allow the tuning control and microphone UP/DWN keys to increase or decrease the operating frequency. Press and hold the key for longer than 1 second to initiate VFO scan. Pressing the key within 10 seconds of pressing the F key will copy the memory channel or call channel data to the VFO.

POWER switch

This switch is used to turn the power on. The display appears about half a second after the switch is pressed.

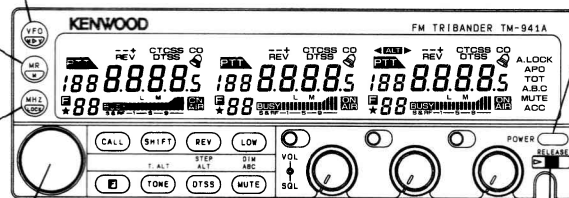

Tuning control

This control is used to select the desired transmit/receive frequency, MHz step, Memory Channel, Frequency Step, Tone Frequency, Scan Direction, etc.

Release button

Slide this button to the right to unlock the front panel from the chassis. There is a microphone socket on the right side of the chassis.

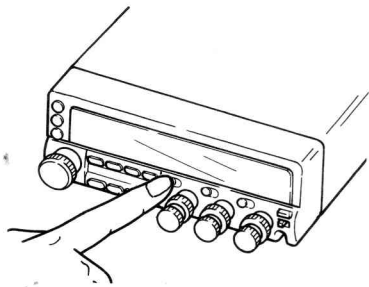

CONTROL SELECT keys (Press) / Current Operating Band indicators

These keys are used to select the key operating band.(To change the transmission band, use the BAND SELECT key.)
The green light shows which band will be controlled by the front panel controls.

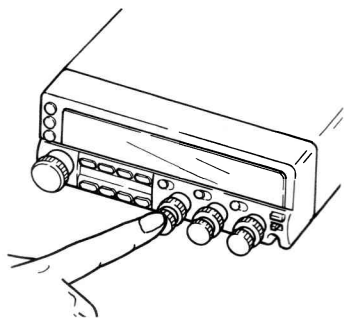
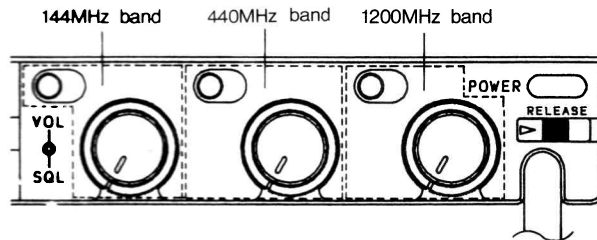
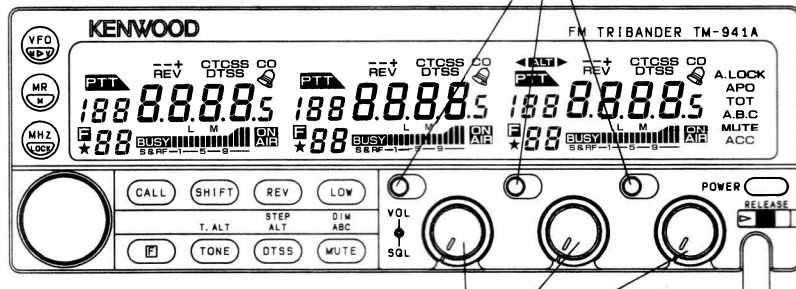

BAND SELECT keys (Press) / VOL controls (Rotate)

These keys are used to select the transmit band. They are also used to select the band you wish to control with the front panel switches. When a key is pressed the "PTT" indicator will flash as a visual signal to show which band has been selected.

VOL controls (Rotate)

These controls are used to adjust the volume.

SQL (Squelch) controls

These controls are used to separately adjust each squelch threshold level.

CALL key

Press this key to activate the call channel function.

Pressing the key for longer than 1 second will initiate VFO/CALL or MEMO/CALL scan.

Pressing the F key momentarily and then pressing this key will store the currently displayed data into the Call channel.

SHIFT key

Pressing this key will cause the radio to shift from one offset direction to the other, i.e. "+" to "-" to simplex where no indicator shows.

REV / STEP key

This key is used to reverse the transmit / receive frequencies during repeater operations. If you have selected simplex this key will not function.

Pressing the F key momentarily and then pressing this key will allow you to select the desired VFO tuning step and scan step size. Use the tuning control to select the desired tuning step.

LOW / DIM key

This key is used to select the transmit output power level.

Pressing the F key momentarily and then pressing this key will allow you to select the desired display intensity with the main tuning control. Four intensity selections are possible.

Press the F key so that the indicators above or below the keys begin to light red.

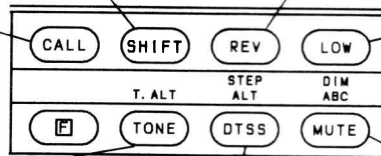

TONE / T.ALT key

Pressing this key causes the radio to select the desired tone signalling mode(T, CTCSS, OFF).

Pressing the F key momentarily and then pressing this key will activate the T.ALT function.

DTSS / ALT key

Pressing this key selects the desired tone signaling mode (DTSS, Paging, or off) (Optional DTU-2 is required).

Pressing the F key momentarily, then pressing this key will cause the ALT function of the 1200 MHz band to activate.

MUTE / ABC key

This key is used to lower the receive audio level by -20dB.

Pressing the F key momentarily and then pressing this key will toggle the ABC function on or off.

■ Function key Assignments

- Press the F key for longer than 1 second so that the key indicator begins to flash, then press the key below.

Key	Function	Refer to
F 1 Sec, VFO	Change Scan Hold/ Resume mode	P.31 4-5-2
F 1 Sec, MR	Memory channel lockout	P.35 4-5-8
F 1 Sec, MHz	Automatic Power off function will turn on or off	P.46 4-10
F 1 Sec, TONE	Tone frequency selection	P.36 4-6-3
F 1 Sec, REV	Beep volume selection	P.46 4-12
F 1 Sec, DTSS	DTSS code selection	P.38 4-7-2
F 1 Sec, LOW	Time-out timer on or off	P.23 4-3-4
F 1 Sec, CONT SEL	Select receive detection output band from the microphone connector	P.17 4-1
F 1 Sec, BAND SEL	Band on or off	P.22 4-3-2

- Press and hold the F key, then the key below.

Key	Function	Refer to
F+ VFO	Enter the programmable scan lower frequency limit	P.32 4-5-4

Key	Function	Refer to
F+ MHz	Enter the programmable scan upper frequency limit	P.32 4-5-4
F+ MR	Clear the displayed memory channel data	P.29 4-4-8
F+ TONE	Bank status display	P.27 4-4-7
F+ DTSS	DTSS delay time selection	P.39 4-7-4
F+ LOW	Memory consolidation	P.28 4-4-7
F+ CONT SEL	Automatic Memory scan	P.34 4-5-7
F+ BAND SEL	Clear Memory Bank	P.29 4-4-8

- Press and hold the key below and turn on the power switch.

Key	Function	Refer to
VFO+ Power ON	VFO reset	P.24 4-4-2
MR+ Power ON	Memory reset	P.24 4-4-2
MHz+ Power ON	All lock on or off during Lock	P.47 4-13
CALL+ Power ON	Demonstration mode on or off	P.35

4-1-2. Display Panel

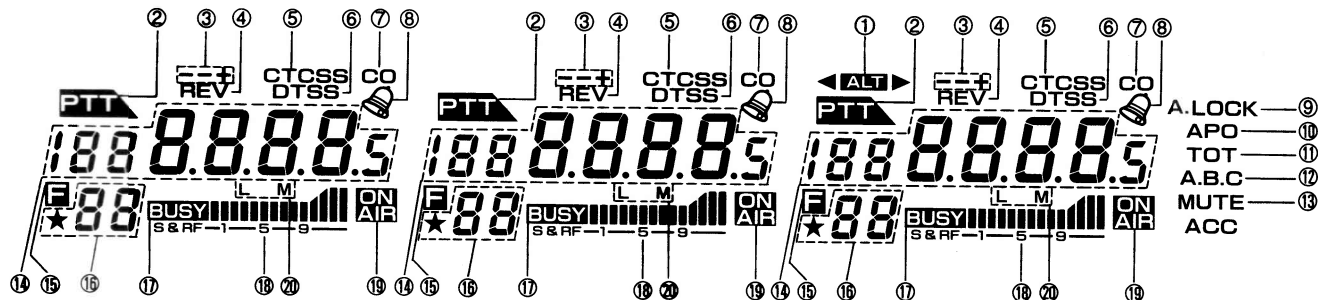

- ① **◀ ALT ▶** 1200MHz band only
On when the Automatic Lock Tuning function is active. When the ALT system is operating the direction indicator will turn on if the system shifts the receiver frequency.
- ② **PTT**
Indicates the TX band.
- ③ **--+**
Displays the selected transmitter offset direction.
- ④ **REV**
On when the Reverse function has been activated.
- ⑤ **CTCSS** With the optional CTCSS unit TSU-7: On when the Tone Decode function is active.
On when the Tone Encode function is active.
- ⑥ **DTSS** On when the DTSS function is active.
- ⑦ **CO** On when Carrier Operated scan is selected.
- ⑧ **💡** On when the Tone Alert function is active.
- ⑨ **LOCK** On when the Lock function has been activated.
- A. LOCK** On when the All Lock function has been activated.
- ⑩ **APO** On when the Automatic Power Off function has been activated.
- ⑪ **TOT** On when the Time-Out Timer function has been activated.
- ⑫ **A.B.C** On when the Automatic Band Change function has been activated.
- ⑬ **MUTE** On when the volume of the RX band is reduced.
- ⑭ **188 8.8.8.8.5** Displays the operating frequency to the nearest kHz digit, or the tone frequency.
The indicator flashes when scanning.
On when receive detection output is fixed in the band.

- ⑮ **F** On whenever the F key has been depressed.
- ⑯ ***BB** Shows the last memory channel number that was selected. The ★ indicator is on when the Memory channel will be skipped during Memory channel scan.
- PBBB** On in paging mode.
- ⑰ **BUSY** On when the squelch opens.
- ⑱ **BUSY**  This level meter indicates the relative receiver signal strength or the relative transmitter power output.
- ⑲ **ON AIR** On during transmit.
- ⑳ **L M** Indicates the relative output power setting for transmit. No indicator indicates full power.

- ① **ANTENNA** connector
Attach an antenna with a low SWR and impedance of 50 ohms.
- ② **13.8 VDC** power input connector
Connect the supplied DC power cable to this connector. Pay close attention to the polarity. Red is positive and black is negative.
- ③ **Fuse** holder
Contains a 15A fuse. Do not use a larger fuse as damage might result to the transceiver.
- ④ **External speaker** jack (Rear panel)
The speaker should have an impedance of 8 ohms. The audio is switched to the external speaker (no sound is output from the built-in transceiver speaker).

4-1-3. Rear Panel and Side Case

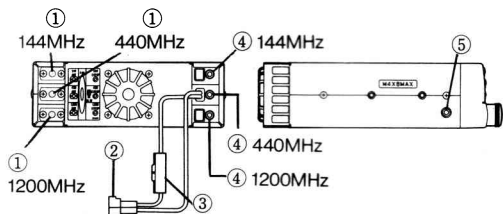

Example

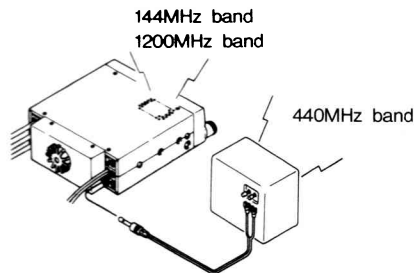

⑤ External speaker jack (Side case)

The speaker should have an impedance of 8 ohms.

The audio is switched from the built-in transceiver speaker to the external speaker (no sound is output from the built-in transceiver speaker).

Example

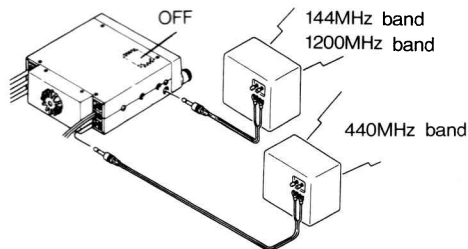

4-1-4. Microphone

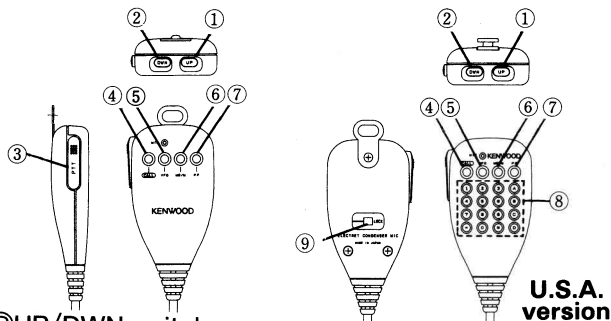

①②UP/DWN switches

These switches can be used to increase or decrease the VFO frequency, the Memory channel number, and the Tone frequency, etc.

③PTT (Push to Talk) switch

The transceiver will transmit whenever this switch is depressed. Scan operations may be canceled by pressing this switch without transmitting.

④CALL key

This key functions just like the CALL key on the front of the radio. (See page 12.)

⑤VFO key

This key functions just like the VFO key on the front of the radio. (See page 10.)

⑥MR key

This key function just like the MR key on the front of the radio. (See page 10.)

⑦PF (Programmable Function) key

This key can be programmed to perform any of the following functions: BAND SEL (*) key (Initial setting from the factory); or MHz, T.ALT, TONE, REV, DTSS, LOW, MUTE, or CONT SEL (*) key.

To program the key use the following procedure:

1. Turn off the POWER switch on the transceiver.
2. Press and hold the key on the front panel of the set that corresponds with the function you wish to program the microphone key to perform.
3. Turn on the POWER switch while the key on the front panel is held in.
4. Release the front panel key.

This will function even if you are operating in the CTCSS decode mode.

(*) Press the PF key set in the CONT SEL or BAND SEL key to cause the radio to switch from a band

to the other. Pressing the PF key for longer than 1 second will not initiate scanning
 Press the PF key set in the CONT SEL or BAND SEL key to cause the radio to switch from one band to the other. Pressing the PF key for longer than 1 second will not initiate scanning.

One additional function can be programmed that is not included on the front panel of the transceiver. This is known as the MONITOR function. This will allow you to open squelch of the selected band to check the band for a clear frequency. This will function even if you are operating in the CTCSS decode mode.

MONITOR programming

Press and hold the F key on the front panel as you turn on the POWER switch of the transceiver and then release the F key.

Ⓜ16-Tone DTMF keypad

These buttons are used to activate the DTMF encoder. See 4-4-4 for further information on their use.

ⓁLOCK switch

This key will deactivate all functions of the microphone except the PTT function.

●Microphone terminal connection

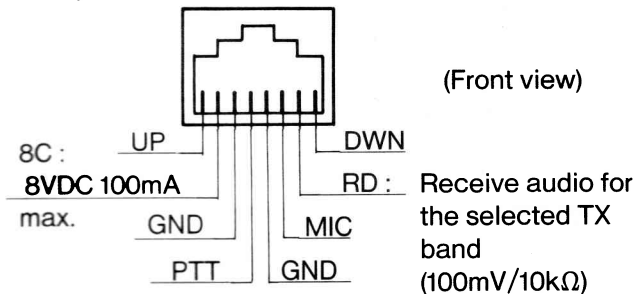

Receive Audio Output Band Selection (RD) connector

The RD terminal will supply an audio signal during receive on the same band that has been selected for transmit. Press the F key for longer than 1 second, and then press the CONT SEL key for the desired band. An indicator will appear in the frequency display of the selected band.



Receive Audio output display
 The 100 kHz dot in the band lights

Used to fix the receive detection output for packet transmission, and so on.

4-2. RECEIVER OPERATION

4-2-1. Receiver Operation

1. Set the controls as follows:

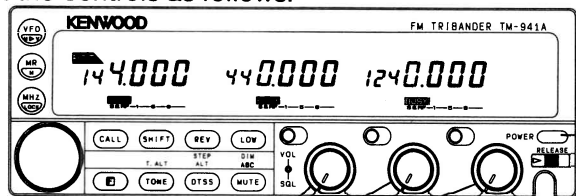

Each Vol Control
Full Counterclockwise
Each SQL Control
Full Counterclockwise

Power Switch
OFF
(Fixed station)
Power switch of
power supply OFF

Fig.1

2. Turn on the Power Supply, then turn on the transceiver's POWER switch. The display should light after 0.5 second. Fig.1 shows examples of frequencies that will appear on the various models.

The frequencies shown above are the default frequencies after a microprocessor reset. If the display shows incomplete data or you think the displayed frequency is in error you should reset the microprocessor Memory Initialization on page 24.

Perform the following steps for each band.

Band selection

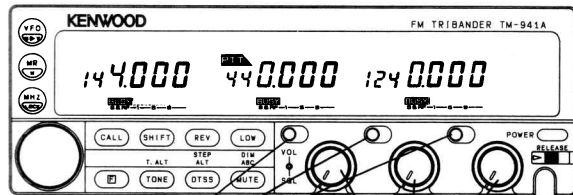

CONTROL SELECT key
Press the desired band
CONTROL SELECT key
to select the operating
band.

BAND SELECT key
Press the BAND SELECT key to
select the desired transmit band.
(The operating band is selected at
the same time.)

3. Press the desired band BAND SEL or CONT SEL key so that the operating band indicator lights (green). Rotate the VOL control clockwise until a signal or noise is heard coming from the speaker.
4. Rotate the tuning control or press the microphone UP/DWN switches to select an open channel.
5. Rotate the SQL control clockwise until the noise just disappears and the BUSY indicator turns off. This point is known as the Squelch Threshold point.
6. Select the desired operating frequency using the microphone or tuning control. When a signal is received the S-meter will deflect and the BUSY indicator will turn on.

- Turn off the transceiver's Power switch before you turn off the power supply, or in a vehicle, before you stop the engine.

NOTE

An internal heterodyne tone resulting from internal mixing may be encountered near by 1244.150 MHz.

4-2-2. Frequency Selection

You can change the dial frequency while in the VFO mode. The frequency can also be stored in memory, or in the call channel.

- Press the VFO key to select the VFO mode.
- Rotate the tuning control or press the microphone UP/DWN switches to select the desired frequency.

Mode selection

You can select the VFO mode, Memory channel mode, or Call channel mode using the following keys.

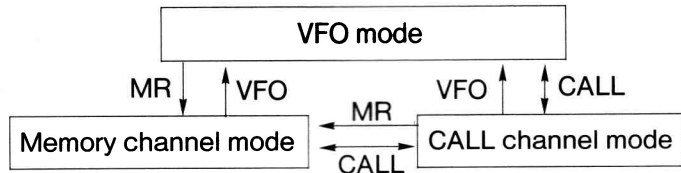

4-2-3. Frequency Step Selection

To select the desired tuning or scan step size use the following procedure:

- Press the VFO key to select the VFO mode.
- Press the F key momentarily. The F indicator should light on the display.
- Press the REV / STEP key within 10 seconds of pressing the F key. The current frequency step size will be displayed.
- Rotate the Tuning control or press the microphone UP / DWN keys until the desired tuning step size appears in the display. The possible frequency step selections are indicated in the chart below.



STEP



Use conventional labeling in charts, ○ = YES, × = NO.

Step Size [kHz]	5↔	10↔	15↔	20↔	12.5↔	25↔
144MHz band	○	○	○	○	×	×
440MHz band	○	○	○	○	○	○
1200MHz band	×	○	×	○	○	○

- To complete the programming of the step size you can press any front panel key or simply wait 10 seconds and the microprocessor will automatically return to the normal frequency display.

The chart below illustrates the way the displayed frequency will change when you change from one step size to another.

5,10,15,20 to 12.5,25		12.5,25 to 5,10,15,20	
0,5,10,15	0	0	0
20,25,30,35	25	12.5	10
40,45,50,55	50	25	20
60,65,70,75, 80,85,90,95	75	37.5	30
		50	50
		62.5	60
		75	70
		87.5	80

For example:

Assume you are presently displaying a frequency of 439.920 MHz and had previously selected a 20 kHz step size. If you were to change the step size to 12.5 kHz the display would then read 439.925 MHz.

4-2-4. A.B.C.(Automatic Band Change)

The A.B.C function allows you to exchange the RX band to the TX band automatically whenever a signal is received and the squelch is open.

1. Press the F key and then press the MUTE / ABC key. The A.B.C. indicator will light on the display.



2. As soon as a signal is received on any band, the TX PTT circuit will become active on that band.



3.

If you press the PTT switch,

The A.B.C. function will be released. The band remains TX band.

If the PTT switch is not pressed,

Within 2 seconds after the signal goes off, the band will be returned to RX band.

If you press the BAND SEL key,

The A.B.C function will be released.

4-2-5. ALT (Automatic Lock Tuning)

1200MHz band only

The ALT system operates similar to an AFC (Automatic Frequency Control) system. This system is useful when the frequency of either station starts to drift. When this occurs distortion of the signal is the usual result. The ALT system will detect the drift and shift the frequency to compensate.

1. Press the F key momentarily. The F indicator will light on the display.
2. While the F indicator is on press the DTSS/ALT key. The ALT indicator will turn on and the receiver will automatically center itself on the incoming signal.



ALT

DTSS

3. To release the ALT function press the F key momentarily, then press the DTSS/ALT key again.

The frequency display will not actually change, even though the receive frequency might shift in order to properly tune the incoming signal. When the ALT system is operating the direction indicator in the display will turn on to signal a change in the receiver frequency.

The direction indicator will show you if the incoming signal is higher or lower than the displayed frequency.

Turns on when the transmit frequency of the distant station is higher than your receive frequency.



Turns on when the transmit frequency of the distant station is lower than your receive frequency.

4-3. TRANSMITTER OPERATION

4-3-1. Transmission

NOTES

1. Ensure that an antenna with a low standing wave ratio (less than 1.5 SWR) is attached to the antenna connector before attempting to transmit. Failure to provide proper termination may result in damage to the final amplifier section.
 2. Always check to ensure the frequency is clear before transmitting.
 3. High-power and extended transmission increase the unit temperature.
1. Press the BAND SEL key for the desired transmission band. The PTT indicator will light for the corresponding band. Bands in which the PTT indicator is not lit are used for reception only.
(Example: 440 MHz band)



2. Select the desired operating frequency .
3. Press the PTT switch. The ON AIR indicator will light, and the RF meter will light.

4. Speak into the microphone. The recommended distance to the microphone is 5 cm (2 inches).

NOTE

Talking closer may result in over deviation of your transmit signal, which might be reported as a loss of clarity or an excessively wide transmit signal. Talking too far away may result in reports of weak audio.

5. Release the PTT switch to return to the receive mode. The ON AIR indicator should go out, and the RF meter will return to zero. Simultaneous reception on the other bands is possible during transmit.

NOTE

Some combination of transmit and receive frequencies might cause a reduction in receiver sensitivity.

4-3-2. Band Selection

Press the F key for longer than 1 second. The F indicator will begin to flash. Press the BAND SEL key for the bands you wish to turn on/off. It is possible to turn off all three bands. In this case no frequencies will be displayed.

When turning off a band an "off" will be displayed in the display for approximately 10 seconds then the appropriate band display will come back.



1 sec



4-3-3. TX. Alert

Different beeps can be heard for each band by pressing the PTT switch. These signal which band you are transmitting on.

Press the PTT switch while pressing the F key. The TX alert function is then turned on or off.

4-3-4. Time-Out Timer (TOT)

The transceiver has a time-out timer function to prevent possible problems caused by continuous transmission. This function forcibly stops continuous transmission after a certain times.

The time-out time is 3, 5, 10, 20, or 30 minutes or OFF (no limit).

1. Press the F key for longer than 1 second.

2. The F indicator will begin to flash. Press the **LOW** key. The current Time-out time is displayed.(For example OFF)



1 sec



3. Select the desired time-out time by rotating the tuning control. The TOT indicator will light. (If the time-out time is set to OFF, the TOT indicator will not light.)
4. Press the LOW key. The time-out timer is now on.

A beep sounds when the time-out timer times out during transmission. The receive state is then re-entered. Press the PTT switch to resume transmission.

4-4. MEMORY

4-4-1. Microprocessor Memory Back-up

A lithium battery is contained in this transceiver to retain memory. Turning off the POWER switch, disconnecting the power cable or an intermittent power failure will not erase the memories. The battery life is estimated at 5 years. When the battery has been exhausted erroneous information might appear in the display.

Lithium battery replacement should be performed by an authorized KENWOOD service facility, or your authorized KENWOOD dealer. This equipment contains CMOS circuitry and can be damaged by improper replacement procedures.

4-4-2. Microprocessor Initialization

band	144MHz	440MHz	1240MHz
VFO,Call channel and Memory channel 1 frequency	144.000 MHz	440.000 MHz	1240.000 MHz
Frequency step	5kHz	25kHz	25kHz
Tone frequency	88.5Hz	88.5Hz	88.5Hz

MEMORY RESET

Press and hold the MR key and turn on the POWER switch. After 1 second all the LCD indicators will light. Release the MR key. All user programmed data will be initialized.

VFO RESET

Press and hold the VFO key and turn on the POWER switch to reset the microprocessor's VFO memory without resetting the memory channels.

4-4-3. Memory Channels

The transceiver has 100 memory channels for each band. The memories are divided into five banks of 20 channels in each.

BANK 1 :	CH 1	~ 20
BANK 2 :	CH 21	~ 40
BANK 3 :	CH 41	~ 60
BANK 4 :	CH 61	~ 80
BANK 5 :	CH 81	~ 100

(4-4-7. Memory Banks Page 27)

4-4-4. Memory Contents

Each Memory channel is capable of storing the following information;

	Normal channel	Odd Split channel
RX Frequency	<input type="radio"/>	<input type="radio"/>
TX Frequency(*)	NA	<input type="radio"/>
Tone (CTCSS) Frequency (With the optional CTCSS unit TSU-7)	<input type="radio"/>	<input type="radio"/>
Tone (CTCSS) status	<input type="radio"/>	<input type="radio"/>
Frequency step	<input type="radio"/>	<input type="radio"/>
Shift status (*)	<input type="radio"/>	NA
REV status (*)	<input type="radio"/>	NA
DTSS code ,DTSS status	<input type="radio"/>	<input type="radio"/>
Last operation paging memory number (With the optional unit DTU-2)	<input type="radio"/>	<input type="radio"/>

: Can be stored in Memory.

NA: Cannot be stored in Memory.

(*) When a separate TX frequency is entered in a memory, the shift state and reverse on/off programming is removed from the memory.

4-4-5. Memory Entry

1. Press the VFO key to select the VFO mode.
2. Select the desired receiver frequency, tone information etc. (For example 147.435 MHz)
3. Press the F key momentarily. The F indicator will light on the display, and a memory channel number will appear.



4. Select any memory channel using the Tuning control or microphone UP/DWN switches.
(For example: CH5)



5. ●Normal channel

Press the MR key within 10 seconds of selecting the memory channel number. The F indicator and memory channel number will turn off. This signals that the data has been properly stored in memory.

● Odd Split memory channel

(continue from step 4)

Press the MR key for longer than 1 second within 10 seconds of selecting the memory channel number.

The - + indicator indicates the TX frequency selection mode.



6. TX frequency entry

Select the desired transmit frequency.

(For example 146.400MHz)



7. Press the MR key.

To confirm the contents of the odd split memory channel:

Press the MR key. The programmed receiver frequency should appear in the display along with both a “-” and “+” offset direction indicator. This signals you that this channel has an odd split entered.



8. To check the transmit frequency press the REV key. The transmit frequency will appear in the display.

● Call Channel

1. Press the VFO key to select the VFO mode.
2. Select the desired Call channel frequency, tone data, etc.
3. Press the F key momentarily. The F indicator will light and the memory channel indicator will light.
4. Press the CALL key within 10 seconds of pressing the F key to enter the data into memory. A long beep will sound and the F indicator and memory channel indicators will turn off to confirm data entry.

4-4-6. Memory Channel Recall

1. Press the MR key to select the memory mode. The last memory channel will light on the display.
2. Rotate the Tuning control or press the microphone UP/DWN keys to select the desired memory channel.

4-4-7. Memory Banks

●Memory Bank link

Adjacent banks may be linked and used as one large bank. All banks can be linked.

Example

- Banks 1 + 2 Channels (1 to 20)+(21 to 40)
- Bank 3 Channels 41 to 60
- Banks 4 + 5 Channels (61 to 80)+(81 to 100)

1. Press the F key. The F indicator will light.
2. Display the highest channel number (20, 40, 60, or 80) of the desired bank using the tuning control or microphone UP/DWN keys.

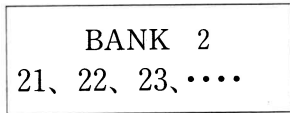
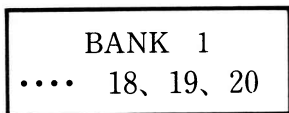

40, 60 or 80

3. Press the band CONT SEL key for linking with the high-order bank.



Number 14 indicates the previous memory channel.

●Link status check

1. Press the CONT SEL key to select the desired operating band.
2. Press the MR key to enter the memory channel mode.
3. Press the TONE key while pressing the F key. The bank status will then be displayed.
4. Turn the tuning control or press the microphone UP/DWN keys to review the band link status.

Example

Banks 1 and 2, and 4 and 5 are linked.

Banks 1 and 2 are linked. Banks 4 and 5 are linked.

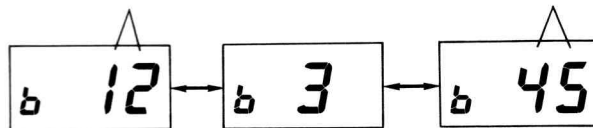

5. Wait for ten seconds or press any of the front panel key to return to the normal frequency display mode.

● Separating linked memory banks

1. Press the F key. The F indicator will light.
2. Display the least significant channel (21, 41, 61, or 81) of a high-order bank using the tuning control or microphone UP/DWN keys.

(Example: When bank 1 is separated from bank 2.)

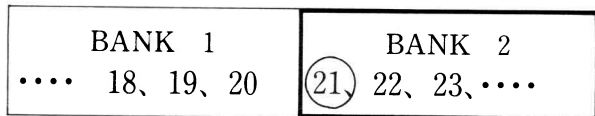

21, 41, 61, or 81

3. Press the band CONT SEL key to separate from the banks.



Number 14 indicates the previous memory channel.

● Memory Consolidation

It is possible to rearrange the memory channels on the TM-941A to optimize memory scan operations. This is an advantage especially if there are a large number of open channels separating those channels that actually contain data. Memory Consolidation causes the active memory channels to be rewritten sequentially from the lowest channel without any blank channels in between. The accompanying diagram illustrates this function.

For Example

Data is currently stored in memory channels 1, 5, 8, 12, 15, 19, and 20.

BEFORE CONSOLIDATION

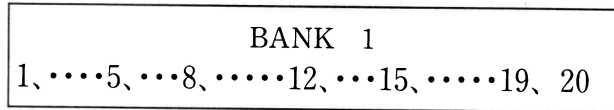

AFTER CONSOLIDATION

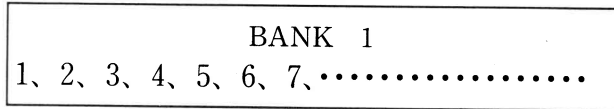

1. Press the BAND SEL or CONT SEL key for the band you wish to consolidate.
2. Press the MR key to enter the Memory Channel Mode.
3. Select any memory channel within the bank you wish to consolidate.

4. Press and hold the F key and then press the LOW key. A beep will sound to signal the consolidation has taken place. The display will change to show the total number of active memory channels after consolidation.

Example

15 channels are memorized in bank 3.

Press and hold



5. To check consolidation on the other banks you can rotate the tuning control, or step thru the memory banks with the microphone UP/DWN switches. The S-meter will show a relative indication of the memory channel usage for the bank, as shown in the accompanying diagram.

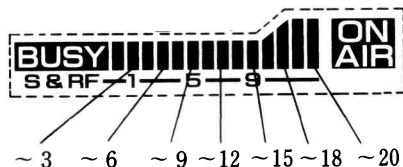

6. To return to the normal frequency display you can wait 10 seconds or press any front panel key.

4-4-8. Clearing Memory

● Clearing a memory channel

1. Select the channel that you wish to clear.
2. Simultaneously press the F key and the MR key.
3. The memory channel will be cleared and the display will indicate the next active memory channel.

● Clearing an entire memory bank

1. Select any channel in the bank that you wish to clear.
2. Simultaneously press the F key and the BAND SEL key.
3. All channels in the selected bank will be cleared. The next active memory channel will be displayed.

NOTES

1. Memory channel 1 cannot be cleared by either the two methods described above.
2. Only the currently displayed bank is cleared during bank link.

4-4-9. Memory Shift

Using this function you can copy the contents of a memory channel or call channel to the VFO without changing the data in memory. This will allow you to begin tuning at the point specified by the memory channel data.

1. Select the desired Memory Channel.

(For example Ch. 5)

2. Press the F key.

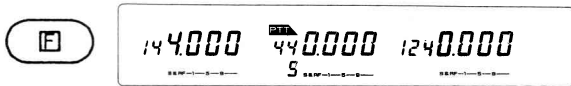

3. Within 10 seconds of pressing the F key press the VFO key to copy the data.



4-5. SCAN

Each band can be scanned independently. For proper scan operation the squelch must be adjusted to the threshold point. Scan can not be used in conjunction with the Tone Alert function.

4-5-1. Scan Options

The following scan options are available:

Band Scan

Scan proceeds over the entire band. This function operates in the VFO mode only.

Programmable Band Scan

The scan range in this mode is specified in memory .

Memory Scan

Scan proceeds through those memory channels in a band or bank that have data stored and have not been locked out. This function operates in the memory mode only.

CALL / VFO Scan

Alternate scanning of the call channel and the VFO.

CALL / Memory Scan

Alternate scanning of the call channel and the memory channel that was last used.

Auto Memory Scan

Scans the band scan range. A station that receives a signal for longer than a second at the time is memorized in an empty channel in bank 5.

4-5-2. Scan Hold / Resume Programming

Two types of scan hold/resume have been provided in this transceiver. The scan hold/resume can be set for each band.

Time Operated Scan (TO)

In this mode the radio stops on a busy channel, remains there approximately 5 seconds, and then continues to scan even if the signal is still present.

Carrier Operated Scan (CO)

In this mode the radio will stop scanning on a busy channel and remain there until the signal drops out. The radio allows a 2 second delay before it resumes scanning so that you don't lose the station when operators change.

NOTE

When the CTCSS is operating, scan will stop only on a signal which contains the proper CTCSS tone.

With the DTSS is operation, scan will stop (with squelch turned off) whenever it receives a signal. Squelch will not open, however, until the proper DTSS signal is received.

With both the CTCSS and the DTSS are turned on scanning will stop when the proper CTCSS tone is received. Squelch will open only if the DTSS signal matches when scan stops.

The radio is delivered from the factory in the Time Operated Scan mode. To switch between the modes use the following procedure.

● Hold/Resume selection

1. Press the F key for longer than 1 second. The F indicator will flash.
2. While the indicator is flashing press the VFO key. This will toggle the Hold / Resume mode to the Carrier Operated mode and the CO indicator will light.
3. To return to Time Operated mode repeat steps 1 and 2.

4-5-3. Band Scan

1. Adjust the SQL control of the band to the threshold point.
2. Hold down the CONT SEL key for longer than a second (for the VFO mode). (The operating band changes at the same time.)
3. The MHz indicator and CONT SEL indicators will begin blinking, and scan will begin.
4. Scan will begin in an upwards direction. You can reverse the direction of scan by turning the Tuning control or pressing the microphone UP/DWN keys. The tuning step size depends upon the current Frequency Step selection.
5. Scan will stop on a busy channel, i.e. a station that is strong enough to open the squelch and turn on the BUSY indicator.
6. Press the microphone PTT switch or any other key (except CONT SEL and BAND SEL). The operating band scan will then stop.

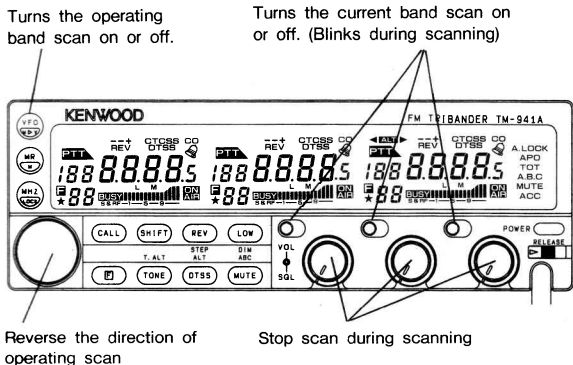

7. You scan all three bands at the same time by repeating step 1 to 6 for the other two bands. Scan will stop only on the band(s) that receive a signal. The other band(s) will continue to scan.

4-5-4. Programmable Band Scan

The lower- and upper-limit frequencies of a program scan are set in advance for each band.

- Lower and the Upper Scan Limits Entry
- Display the lower frequency limit, press and hold the F key then press the VFO key.
- Display the upper frequency limit, press and hold the F key then press the MHz key.

● Operation

1. Adjust the SQL control to the threshold point.
2. Select a frequency between the two programmed scan limits.
3. Press the VFO key. The MHz indicator will begin flashing as a visual reminder the transceiver is scanning.

NOTE

When the current frequency step is different from the upper or lower limit frequency step, the frequencies are scanned from the lower limit and the step depends on that of the lower frequency limit.

Continue to 4-5-3 step 4.

4-5-5. Memory Channel Scan

NOTE

Only those memory channels that have data entered, and that have not been locked out it will be scanned. Scan does not start unless there are 2 channels that have data entered.

The memory in a band and bank can be scanned.

1. Adjust the SQL control to the threshold point.

2. ● Memory scan in band

Press the CONT SEL key or the BAND SEL key of the band to change the operating band.

Press the MR key for longer than 1 second to initiate memory scan of the band.

● Memory scan in bank

When the band is in the memory channel mode press the CONT SEL key for longer than 1 second to initiate memory bank scan.(The operation band changes at the same time.)

Continue to 4-5-3 step 4.

4-5-6. CALL Scan

CALL / VFO Scan

Press the CALL key for longer than 1 second in the VFO mode to start alternate scanning of the VFO frequency shown on the display and the call channel.

CALL / Memory Channel Scan

Press the CALL key for longer than 1 second in the memory channel mode to start alternate scanning of the call channel and the memory channel that was last used.

4-5-7. Automatic Memory Scan

This function will cause the transceiver to begin a search for active channels. When it acquires a signal that lasts for at least one second it will sequentially write the data into open memory bank number 5 channels as illustrated in the accompanying diagram.

1. Press and hold the F key.
2. Then press the CONT SEL key for the band you want to scan. A beep will sound and the radio will begin scanning.
3. Release both keys.

The transceiver will beep each time it enters a frequency into memory. Scanning will stop once it has entered a frequency into all of the open (bank 5) memory channel positions.

Bank 5 memory status
before auto memory scan

81	
82	
83	144.800 DTSS
84	144.900
85	
.	
.	
98	145.000 CTCSS
99	
00	

Bank 5 memory status
during auto memory scan

81	145.040
82	145.080
83	144.800 DTSS
84	144.900
85	145.560
.	
.	
98	145.000 CTCSS
99	
00	

Band scan

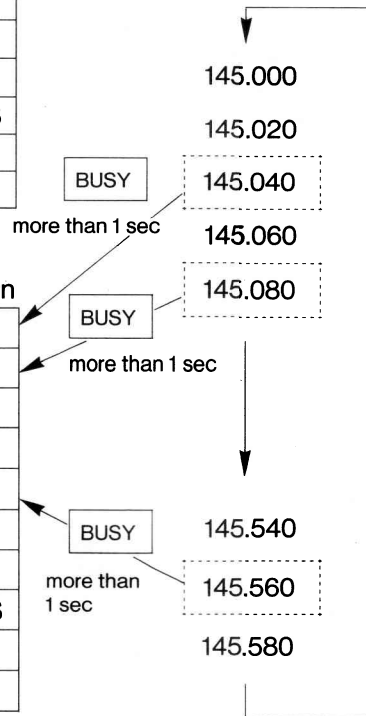

4-5-8. Memory Channel Lockout

This function allows you to specify which memory channels you wish to skip during memory channel scan.

1. Press the MR key to select the memory channel mode.
2. Select the memory channel that you wish to skip by turning the Tuning control or pressing the microphone UP/DWN keys.
3. Press the F key for longer than 1 second. The F indicator will begin to flash. Within 10 seconds of pressing the F key press the MR key. A ★ indicator will appear to the left of the memory channel number. This indicates the memory channel will be skipped during the memory channel scan mode.



more than 1 sec



4. Repeat steps 2 and 3 to lock out any other channels you wish to skip.
5. To cancel the lockout, select the desired memory channel as described in steps 1, 2 and 3 above. A ★ indicator should appear to the left of the memory channel number. Press the F key for longer than 1 second and then press the MR key. The ★ indicator should turn off.

Demonstration mode

The microprocessor has been programmed to provide a short demonstration of the capabilities of the TM-941A transceiver. To activate this demonstration press and hold the CALL key while you turn on the power switch. After a 10 seconds delay the transceiver will enter the demonstration mode.

You can cancel this function by holding the VFO key down while you turn on the power.



enjoy Your hobby



CAUTION

When you cancel the demonstration mode you will clear all VFO information, and reset the VFO's to the factory defaults. You won't erase your memory channel data, just the VFO data, so you might wish to store your VFO data into memory before entering the demonstration mode so this information can be easily recalled.

4-6. REPEATER OPERATION

4-6-1. Transmitter Offsets

All amateur radio repeaters use a separate receive and transmit frequency. The receive frequency may be above or below the transmit frequency. The configuration of most repeaters fall into one of the categories listed below:

	144 MHz band	440 MHz band	1200 MHz band
+	+600 kHz	+5 MHz	+12 MHz
-	-600 kHz	-5 MHz	-12 MHz
--			-20 MHz

● Offset Direction

To select the desired transmitter offset direction press the SHIFT key. Each time you press the key the transceiver advances from one direction to the other, i.e. “+” to “-” (“-” to “--” with 1200 MHz band) to no offset (simplex).

● Automatic Offset Selection (U.S.A., and Canada versions)

The TM-941A has been programmed according to the standard ARRL (Amateur Radio Relay League) Band Plan with regard to transmitter offset direction.

See the accompanying chart for additional information about this programming. You can, of course, override this by using the SHIFT key if desired.

145.1	145.5	146.0	146.4	146.6	147.0	147.4	147.6	148.0	
S	-	S	+	S	-	+	S	-	S

S : simplex

4-6-2. Reverse Function

Some repeaters use a “Reverse Pair”, i.e. the transmit / receive frequencies are the reverse of other repeaters. For example, repeater A uses 146.000 for a transmit frequency (INPUT) and 146.600 for a receive frequency (OUTPUT). Repeater B might use 146.600 for a transmit frequency and 146.000 for a receive frequency. It would be inconvenient to have to reprogram the transceiver each time you wanted to use these repeaters.

The REV key allows you to easily reverse the transmit and receive frequencies. To use the REV function press the REV key. The REV indicator goes on on the display to indicate that you are working a reverse pair.

To return to normal press the REV key again. The REV indicator goes off.

This function is also useful to check the input frequency of the repeater so that you can determine if you are within range for simplex communications.

4-6-3. Tone and CTCSS Operation

Some repeaters require the use of a control signal to activate the repeater. Several different methods are currently in use. In the United States sub-audible tones are sometimes used, 38 different sub-audible frequencies being possible.

The CTCSS function has been activated the radio will not open squelch until the proper tone is received.

● Tone Frequency Selection

Each band can be selected the Tone Frequency independently.

1. Press the F key for longer than 1 second. The F indicator will flash. Press the TONE key. The current tone frequency will show in the display.

2. Rotate the Tuning control or press the microphone UP/DWN key to select the desired tone frequency.
3. When the desired tone frequency is selected, the previous mode is resumed 10 seconds after selection or when the any front panel key is pressed.

Tone Frequency (Hz)

67.0	82.5	97.4	114.8	136.5	162.2	192.8	233.6
71.9	85.4	100.0	118.8	141.3	167.9	203.5	241.8
74.4	88.5	103.5	123.0	146.2	173.8	210.7	250.3
77.0	91.5	107.2	127.3	151.4	179.9	218.1	
79.7	94.8	110.9	131.8	156.7	186.2	225.7	

● Tone/CTCSS Operation

Press the TONE key and select the desired Tone mode. When the T indicator appears in the display the transmitter will transmit the desired tone. Tone signals can be transmitted.

When the CTCSS indicator appears in the display the transceiver will transmit the desired tone and will also operate in the Tone Squelch mode, i.e. the squelch will not open until the proper tone is received as a portion of the incoming receive signal.

When no indicator is on, the radio will not make use of either tone feature. Set TONE to OFF for transmission with a repeater or transmission without tone squelch (CTCSS).

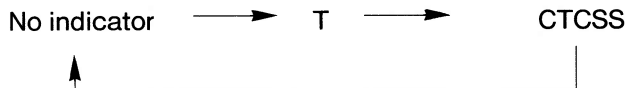

4-6-4. Autopatch Operations (U.S.A. versions only)

Some repeaters offer a service known as autopatch. This feature allows you to dial a telephone number from your transceiver and carry out a telephone conversation, much like a car telephone, or cellular telephone. This function requires the use of a DTMF (Dual Tone Multi Frequency) pad. The MC-45DM optional microphone provides the normal keys you would have on your telephone at home, in addition to the normal 12 keys that are found on your telephone as well as 4 additional keys, A, B, C and D. These keys are required by some repeater systems for various control operator of your repeater to determine if their use is required. A chart is provided that lists the various tone frequencies that are generated by the keypad. (Fig.1)

To activate the keypad:

1. Press and hold the PTT switch.
2. Press the keys just like you would dial your telephone at home.
3. The transceiver will remain keyed for approximately 2 seconds after you press each number, so you can release the PTT switch without unkeying the transceiver.

NOTE

Some repeaters will require the use of a special key sequence to activate the autopatch function. You should check with your control operator for this sequence.

(Hz)	1209	1336	1477	1633
697	1	2	3	A
770	4	5	6	B
852	7	8	9	C
941	*	0	#	D

4-7. DTSS (Dual Tone Squelch System) (Requires optional DTU-2)

This function allows the squelch to be turned on in the receive mode on reception of a three-digit code matching the DTSS code selected in your radio.

Once the squelch is turned on by reception of a matching code, it operates normally from then on. If no signal is received for longer than 2 seconds, the squelch is turned off until a matching code is received.

NOTE

This function is not available in some areas.



4-7-1. DTSS code

DTSS codes from 000 through 999 can be selected from the VFO mode and stored in memory channels and CALL channel.

The initial setting of the DTSS Code is 000.

4-7-2. DTSS Code Selection

1. Press the DTSS key 1 or 2 times until DTSS appears in the display.

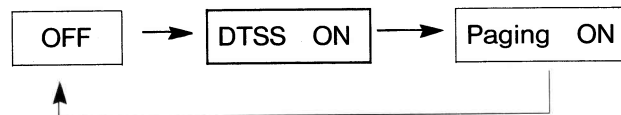

2. Press the F key for longer than 1 second and then press the DTSS key. The display will change to the DTSS code entry mode. (See example below.) The digit just to the right of the "C" will be flashing.



more than 1
second



3. Select any digit from 0-9 by rotating the Tuning control, or by pressing the UP/DWN switches on the microphone, then press the DTSS key. (Or press the desired digit on the microphone keypad.)
4. After you select the first digit a beep will sound and the middle digit will begin flashing. Select the desired digit by using any of the methods described above.
5. Select the final digit as described above. After the last digit has been entered the display will return to the normal frequency mode, indicating the tone selection process has been successfully completed.

NOTES

1. If a key other than the DTSS key is pressed during operation, code selection mode is canceled.
2. If no action is taken for longer than 10 seconds, code selection mode is automatically canceled.

4-7-3. Using the DTSS function

1. Adjust the SQL control to the threshold point.
2. Press the DTSS key 1 or 2 times until the DTSS indicator appears in the display.
3. The squelch will now remain closed until the correct code group is received.
4. When the PTT switch is pressed on the microphone the selected code group will be transmitted. It will take about 1/2 second to transmit the 3 tones. The microphone will be muted while the tones are being transmitted.
5. To cancel DTSS operation press the DTSS key until the DTSS indicator turns off.

4-7-4. Using DTSS with a Repeater

The DTSS signal is not transmitted immediately after you press the PTT switch. A programmable delay time has been incorporated to allow the DTSS signal to be passed by repeaters with slow response times. You can select a delay time of 250 mS, 450 mS, 750 mS, 850 mS, or 1 second.

When operating simplex mode the 250mS will automatically be selected for you. No other choice is available in this mode, even though you may have selected a different delay.

In modes other than simplex you may select between the remaining delay periods (450 mS, 750 mS, 850 mS, or 1 second).

NOTE

250mS cannot be selected for offset modes.

To select desired delay time :

1. Press and hold the F key, then press the DTSS key. The display will indicate the current delay (250mS is not displayed).

Press and hold



2. Rotate the tuning control or press the microphone UP/DWN switches to select the desired delay time.
3. To return to the normal frequency display wait 10 seconds for automatic return, or press any key.

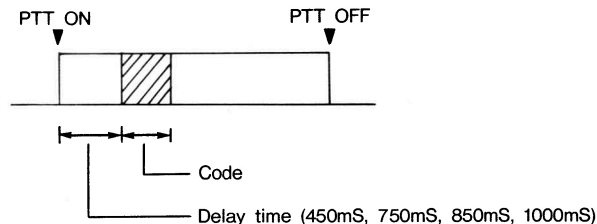

4-8 PAGING (Requires optional DTU-2)

The function is useful for net operations or for selectively calling an individual calling.

Example: When member 2 is called

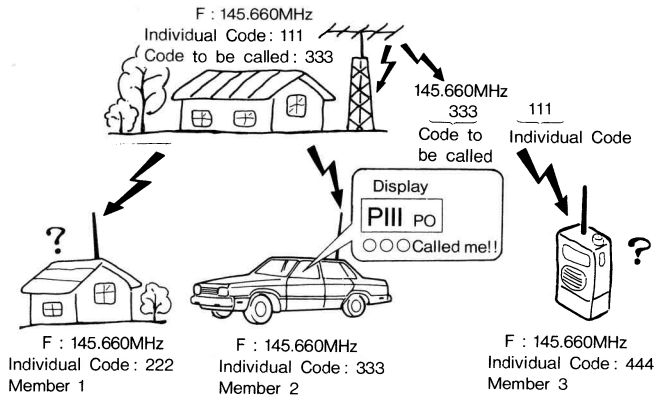

Normal operating procedure would require that you make prior arrangements with all members of the group/net, so that all interested parties know which DTMF code will be used for individual/group calls, and that everyone knows who uses which individual code. Since the paging system makes use of a 3 digit code (000 thru 999) you could have a very large group and still have extra code groups available.

The paging function permits the 3 digit code of the calling station to be displayed in the display to allow easy identification of the calling station.

Simplified operation procedure

Set your individual DTMF code.

Select the desired operating frequency .

Enter the paging mode.

To call other stations

- 1). Select the DTMF code for the distant station.
- 2). Transmit
- 3). Make the QSO.

To listen for a call,
wait for the squelch
to open.

4-8-1 Paging Code Memories

Seven different paging code memories have been provided.

Paging Code Memory No.	Usage
A	Stores your own station code.
0	Automatically stores the calling station's code during receive. Can be used to temporarily store the code for the station to be called.
1~5	Stores group codes, and the codes of other stations.

4-8-2. Code Selection

First, set a code for each band.

1. Press the DTSS key until the Paging indicator lights in the display. See the example below.

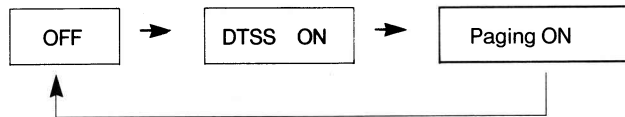

2. Press the F key for longer than 1 second. A beep will sound and the F indicator will begin flashing. While the F indicator is flashing press the DTSS key.

3. The display will change to the Paging Code Memory Channel Selection mode and the Paging Code Memory Channel indicator will begin flashing. Rotate the tuning control or press the microphone UP/DWN switches to select the desired Paging Code Memory Channel.
4. Press the DTSS key to complete the Paging Code Memory Channel Selection and enter the Paging Code Selection mode. The first digit to the right of the large "P" will begin flashing.
5. Rotate the tuning control, press the microphone UP/DWN switches, or press the appropriate key on the microphone keypad to select the first digit of the paging code.
6. Press the DTSS key to enter this digit into memory. The middle digit will then begin flashing.
7. Repeat steps 5 and 6 to complete the programming of this particular paging code. After you enter the final digit of the code the display will return the Paging Code Selection mode.
8. Select the next Paging Code Memory you wish to program as described in 3-7 above.
9. After you have completed programming the Paging Code Memory you can return to the normal frequency display by waiting 10 seconds, or by pressing any front panel key except the DTSS key.

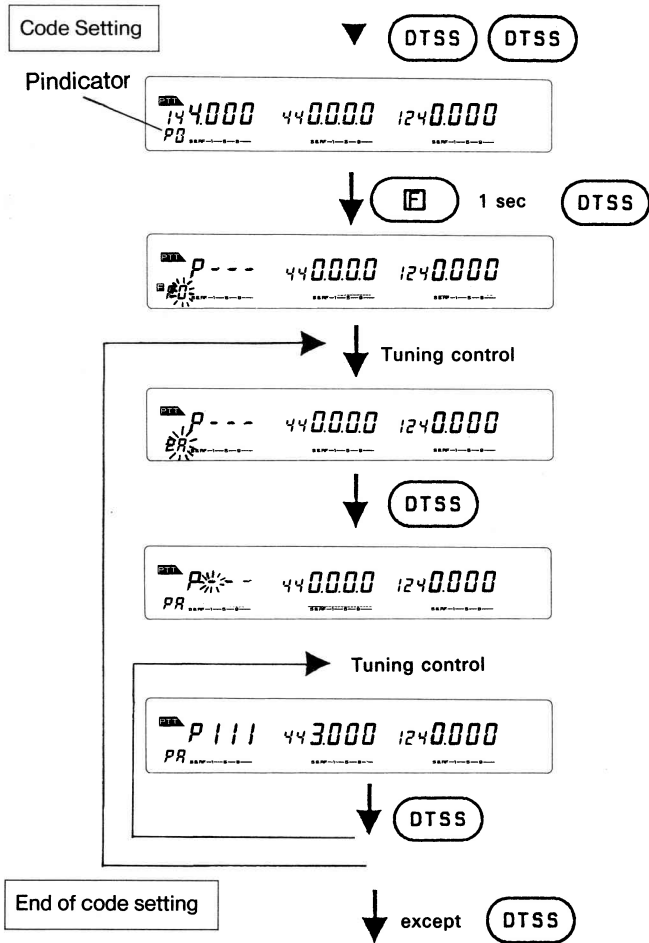

4-8-3. Code Transmission

Your station ID code should be programmed in Paging Code Memory Channel A.

1. Select the desired operating frequency.
2. Press the DTSS key until the Paging mode indicator appears. (The Paging mode should be active on the other transceiver also!)
3. Press the F key for longer than 1 second and press the DTSS key. The Paging Mode Memory Channel Indicator will begin flashing.
4. Select the desired Paging Code Memory Channel with the tuning control or microphone UP / DWN switches.

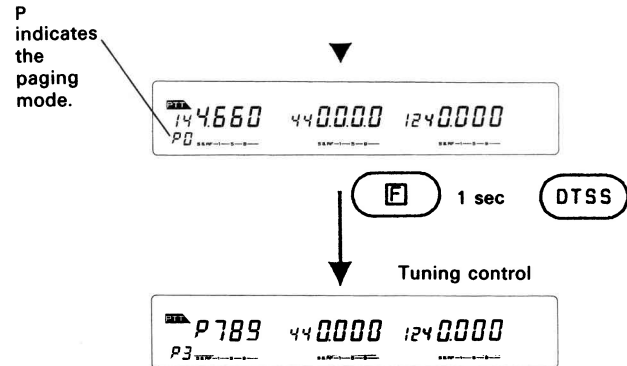

5. Press any key except the DTSS key to return to the frequency display.
6. Press the PTT switch. The selected transmit code will be transmitted along with your station ID code (the one stored in A).

For example, the following groups communicate with each other.

Predetermined frequency	144.660MHz
Group code	789
Member 1	Individual code 111
Member 2	Individual code 222
Member 3	Individual code 333
Member 4	Individual code 444

<p>Member 1</p> <p>A 111</p> <p>0</p> <p>1</p> <p>2</p> <p>3 789</p> <p>4 444 ★</p> <p>5</p>	<p>Member 2</p> <p>A 222</p> <p>2 789</p> <p>0</p>	<p>Member 4</p> <p>A 444</p> <p>4 789</p> <p>0</p>
	<p>Member 3</p> <p>A 333</p> <p>3 789</p> <p>0</p>	

4-8-4. Paging Code Monitoring

1. Select the desired operating frequency.
2. Press the DTSS key until the Paging Mode indicator appears in the display.



P indicator is blinking mode.

3. When the proper code is received, your squelch will open and you will hear an alert tone sequence coming from the speaker. The display will indicate the individual or group code of the calling station.

Stand by with individual code

If the calling station transmits your individual call the display will show Paging Mode Memory Channel 0, and will display the ID code of the calling station. (Example: Frequency: 144.660 MHz, calling station ID code is 444.)



Zero is displayed to indicate that the station is being called.

Stand by with group code.

If the calling station transmits the group code, the group code and the Paging Mode Memory Channel Number that contains that code will display.

(Example : For member 2, group code 789 is stored in Paging Mode Memory Channel 2.)

P indicator
flashes

group code



This code becomes a number other than 0 to indicate group calling.

(* : Err will appears in the display if there is a problem in code identification.)

Error
indicator



To increase efficiency we recommend cancelling the paging mode after initial calls have been made to prevent transmitting the Paging Code data each time the PTT switch is depressed.

4-8-5. Code Lockout

(Codes are locked out only for receive during the Paging Mode.)

It is possible to temporarily disable Paging Code Memories 1,2,3,4, and 5 during receive. This will allow you to more closely control which individuals, or groups can open your squelch at any given time.

Paging Code Memories 0 and A cannot be locked out. Locking out a particular code for receive will not prevent the code from being transmitted, should you select that particular Code Memory.

1. Press the DTSS key until the Paging Mode indicator appears in the display.
2. Press the F key for longer than 1 second and then press the DTSS key.
3. Select the Paging Code Memory Channel number you wish to lock out by using the tuning control or the microphone UP/DWN switches.
4. Press the MR/M key.
A ★ will appear to the left of the Paging Code Memory Channel indicator to remind you that you have locked out this code memory for receive.
5. To restore the code memory for receive use repeat steps 1 thru 4 above.



4-9. TONE ALERT SYSTEM

The Tone Alert function will provide an audible alarm to signal when someone is transmitting on the frequency you are monitoring. Each band can be selected by the T.ALT function independently, and different alarm tones are produced for each band. During the T.ALT function you will not hear voice communication. When used in conjunction with the CTCSS function this would allow the transceiver to act similar to a private pager system!

1. Adjust each SQL control to the threshold point.
2. If you will be using the CTCSS function you should select the proper tone frequency and ensure the CTCSS indicator is on in the display.
3. Press the F key, then the TONE/T.ALT key. T.ALT indicator will light .
4. When a signal is present:
The T.ALT indicator will flash.
The transceiver will beep for approximately 5 seconds.
The elapsed time is counted up.
Up to 15 T.ALT operations are counted on the memory channel display.



5. The elapsed time is displayed in minutes, to a maximum of 59 hours 59 minutes. The display is rewritten by each new signal.
6. During time display the T.ALT function can be released by pressing any front panel key.
7. The T.ALT function can be released by pressing the F key, then the TONE/T.ALT key again.

NOTES

1. When using CTCSS the incoming signal must be present for approximately 1 second in order for the T.ALT to function properly.
2. If the DTSS function is used in conjunction with the Tone Alert function, Tone Alert is activated only when the same DTSS signal is received.
3. The tone alert function is not activated when CTCSS and DTSS signals are on.
4. You can hear a transmission when the PF key is pressed while the Tone Alert function is activated with the microphone PF key set to the MONITOR switch. (MONITOR page)
5. The automatic power off function works after 59 hours and 59 minutes plus one minute when it is used with the tone alert function.
6. If the PTT switch is pressed while the A.B.C. function is being used, the A.B.C. function is canceled first. If the PTT switch is pressed again, the BELL function (T.ALT) is canceled.

4-10. AUTOMATIC POWER OFF (APO)

This transceiver also provides an Automatic Power off circuit. The circuit action is described below. (Initial state is off.)

1. To turn the APO function on/off, press the F key for longer than 1 second and then press the MHz key .



1 sec



2. A 5 second audio confirmation alert will sound after 2 hours 59 minutes if no signal has been received and if you have not performed any operation.
1 minute after this alert signal the transceiver will shut itself off.
3. When the APO operates and the transceiver is shut off, the transceiver can be reactivated by turning the POWER switch off and back on.

4-11. DIMMER (DIM)

The intensity of illumination can be set to one of four levels. (D1 thru D4, with D1 being the brightest.)

1. Press the F key, then press the LOW/DIM key while the F indicator lights. The display will show which intensity level is currently in use.



DIM



2. Select the desired value (D1 to D4) with the tuning control or the UP/DWN key on the microphone.
3. If, after 10 seconds, no key has been pressed, the displayed level is set and the previous frequency is re-displayed.

4-12. BEEP

The beep can be set to one of eight levels (off to b7).

1. Press the F key for longer than a second, then press the REV key while the F indicator is flashing. The display will show which beep level is currently in use.
2. Select the desired value with the tuning control or the UP/DWN key on the microphone.
3. If, after 10 seconds, no key has been pressed, the displayed level is set and the previous frequency is re-displayed.



1 sec



4-13. KEY LOCKS

There are three types of lock function.

① Microphone key lock

When the switch on the rear of the microphone is set to the LOCK position, all the microphone keys except the PTT switch are disabled.

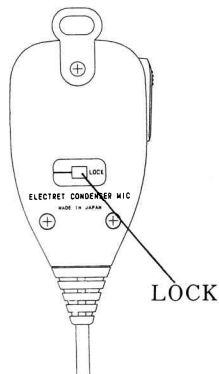

② LOCK

All the panel keys and the Tuning control are disabled. However, the microphone keys work. Press the F key, then press the MHz/LOCK key within 10 seconds. The LOCK indicator lights.



③ ALL LOCK

All operations, except the power switch, volume, and squelch, are disabled.

Switch the power off while the LOCK indicator is on, hold down the MHz/LOCK key, and switch the power on again. The A LOCK indicator lights.



To release A LOCK, switch the power off while the A LOCK indicator is on, press and hold the MHz/LOCK key, and switch the power on again. The A LOCK operation cannot be canceled by VFO reset or MR reset.

5. BLOCK DIAGRAM and SCHEMATIC DIAGRAM

another sheet

6. MAINTENANCE

●GENERAL INFORMATION

Your transceiver has been factory aligned and tested to specification before shipment. Under normal circumstances the transceiver will operate in accordance with these operating instructions. All adjustable trimmers and coils in your transceiver has been adjusted at the factory and should only be readjusted by a qualified technician with proper test equipment. Attempting service or alignment without factory authorization can void the transceiver's warranty.

When operated properly, the transceiver will provide many years of service without requiring realignment. The information in this section gives some general service procedures which can be accomplished without sophisticated test equipment.

●SERVICE

Should it ever become necessary to return the equipment to your dealer or service center for repair, pack it in its original box and packing, and include a full description of the problems involved. Also include your telephone number. You need not return accessory items unless directly related to the service problem.

SERVICE NOTE:

Dear OM, if you desire to correspond on a technical or operational problem, please make your note short, complete, and to the point, and PLEASE make it readable.

Please list: Model and serial number.

The problem you are having.

Please give sufficient detail to diagnose. Information such as other equipment in the station, meter readings and anything else you feel might be useful in attempting diagnosis.

CAUTION:

Do not pack the equipment in crushed newspapers for shipment. Extensive damage may result during shipment.

NOTES:

1. Record the date of purchase, serial number and dealer from whom purchased.
2. For your own information, retain a written record of any maintenance performed on the unit.
3. When claiming warranty service, please include a photocopy of the bill of sale, or other proof of purchase showing the date of sale must accompany the transceiver.

● IN CASE OF DIFFICULTY

The problems described in this table are failures caused, in general, by improper operation or connection of the transceiver, not by defective components. Examine and check according to the following table.

Symptom	Probable cause	Corrective action
Indicators do not light and no receiver noise is heard when the POWER switch is turned on.	<ol style="list-style-type: none"> 1. Bad power cable or connections. 2. Blown power supply fuse. 	<ol style="list-style-type: none"> 1. Check cables and connections. 2. Check for the cause of the blown fuse and replace the fuse.
No sound from the speaker. No signal can be received.	<ol style="list-style-type: none"> 1. Squelch is closed. 2. With the TSU-7 : CTCSS is operating. 	<ol style="list-style-type: none"> 1. Turn the SQL control counterclockwise. 2. Press the TONE/T.ALT key to turn off the CTCSS.
No transmitter output.	<ol style="list-style-type: none"> 1. Microphone jack is not plugged in. 2. Poor antenna connection. 	<ol style="list-style-type: none"> 1. Plug jack in. 2. Connect antenna securely.
Weak signal cannot be received.	Poor antenna connection.	Connect antenna securely.
Display is dark.	<ol style="list-style-type: none"> 1. Power voltage is low. 2. DIM had been set too dark. 	<ol style="list-style-type: none"> 1. Check voltage for 13.8 VDC \pm15 %. 2. Press the F key and the LOW/DIM key. See page 46.
Memory cannot be backed up.	Backup battery voltage is low.	See Microprocessor memory backup page 24.
The display does not change when the tuning control is rotated.	<ol style="list-style-type: none"> 1. The LOCK function is on. 2. The A LOCK function is on. 	<ol style="list-style-type: none"> 1. Press the F key, then press the MHz / LOCK key within 10 seconds. 2. Hold down the MHz / LOCK key, switch the power on, then perform the operation in 1.

Some dial frequency relationships may result in internal heterodyne tones being generated by the TM-941. This is not a defect.

The following formulas may be used to determine if a tone will be present with a particular frequency relationship.

If any of the following equations are true, a tone may be generated that is strong enough for you to hear it in the speaker of both bands. These tones can only be generated when more than one band is on at a time:

$$((1.2\text{GHz operating frequency}) - 59.7\text{MHz}) \times 2 - ((70\text{CM operating frequency}) - 21.6\text{MHz}) \times 5 = 59.7 \text{ MHz}$$

or

$$((70\text{CM operating frequency}) - 21.6\text{MHz}) \times 4 - (((1.2\text{GHz operating frequency}) - 59.7\text{MHz}) / 2) \times 3 = 59.7 \text{ MHz}$$

or

$$((1.2\text{GHz operating frequency}) - 59.7\text{MHz}) \times 2 - ((70\text{CM operating frequency}) - 21.6\text{MHz}) \times 5 = 21.6 \text{ MHz}$$

7. OPTIONAL ACCESSORIES 7-1. ACCESSORIES

CTCSS UNIT

TSU-7

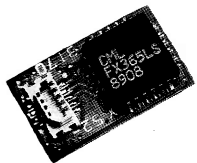

DTMF UNIT

DTU-2



MOBILE MOUNT
BRACKET
MB-11

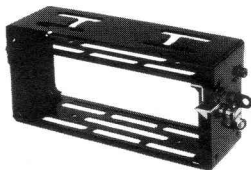

DETACHABLE FRONT
PANEL KIT (4m)
PG-4K



DETACHABLE FRONT
PANEL KIT (7m)
PG-4L



MULTI FUNCTION
MICROPHONE
MC-45



MULTI FUNCTION
MICROPHONE WITH DTMF
MC-45DM



DC LINE
NOISE FILTER
PG-3G



DC POWER
CABLE
PG-2N



MOBILE SPEAKER
SP-41



COMMUNICATIONS SPEAKER
SP-50B

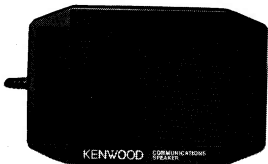

DC POWER SUPPLY
PS-430

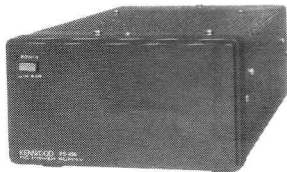

DC POWER SUPPLY
PS-50



7-2. INSTALLING OPTIONAL ACCESSORIES

CAUTION

Before installation, be sure to disconnect the DC power supply, or damage may occur to the equipment.

7-2-1. CTCSS Unit (TSU-7)

1. Slide the release button on the front panel to the right. Pull the front panel toward you from the right, then remove the whole panel unit. Be careful with the cord connecting the front panel unit to the main unit. (Fig. 1)
2. Remove the backing from the cushion provided with the TSU-7 and attach it to the back of the TSU-7 as shown in Fig. 3.
3. Remove the backing from the other side of the small cushion. (Fig. 3)
4. Insert the CTCSS connector directly into the TSU-7 connector on the PC board, then gently push it down until it seats. (Fig. 3)
5. Replace the front panel back, taking care not to trap the connecting cord. The connecting cord is easier to manage when it is put in the groove on the back of the panel.(Fig. 2)

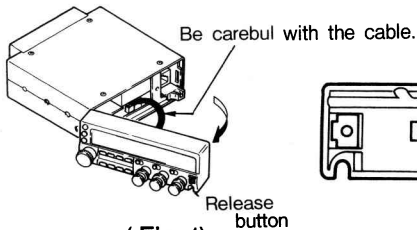

(Fig. 1)

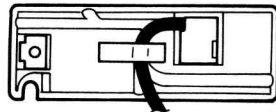

(Fig. 2)

7-2-2. DTMF Unit (DTU-2)

1. Slide the release button on the front panel to the right. Pull the front panel toward you from the right, then remove the whole panel unit. Be careful with the cord connecting the front panel unit and the main unit. (Fig. 1)
2. Remove the backing from the cushion provided with the DTU-2 and attach it to the back of the DTU-2 as shown in Fig. 3.
3. Use the cable supplied with the DTU-2 and attach the two connectors to the main unit. (Fig. 3)
4. Attach the DTMF unit to the main unit as shown in Fig. 3.
5. Replace the front panel back, taking care not to trap the connecting cord. The connecting cord is easier to manage when it is put in the groove on the back of the panel.(Fig. 2)

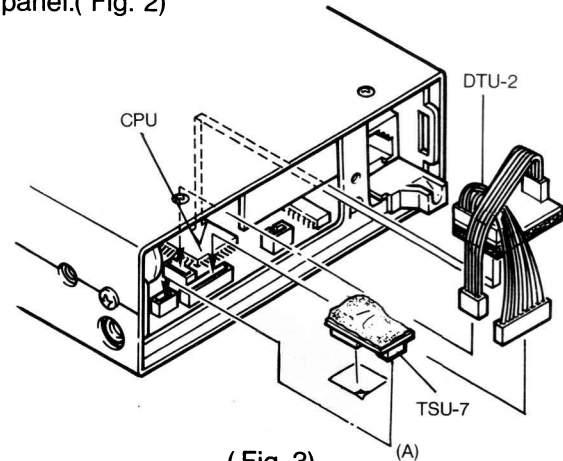

(Fig. 3)

7-2-3. Panel Separate Kit (PG-4K/4L)

PG-4K

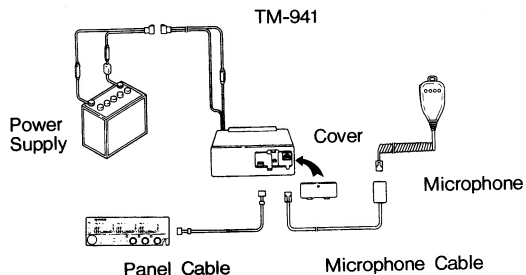

- Slide the release button on the front panel to the right. Pull the front panel unit toward you from the right, then remove the whole panel unit. Be careful with the cord connecting the front panel unit and the main unit. (Fig. 1)



(Fig. 1)

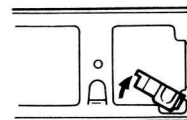

Remove the holder.

(Fig. 2)

- Unplug the microphone from the main unit, and remove the black plastic cord holder by pushing up on the front. (Fig. 2)
- Unplug the front panel cord connected to the transceiver main unit and connect the PG-4K/4L front panel cable to the transceiver.

PG-4L

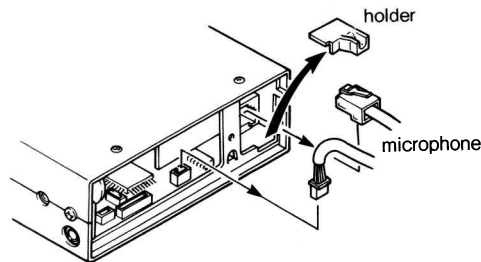
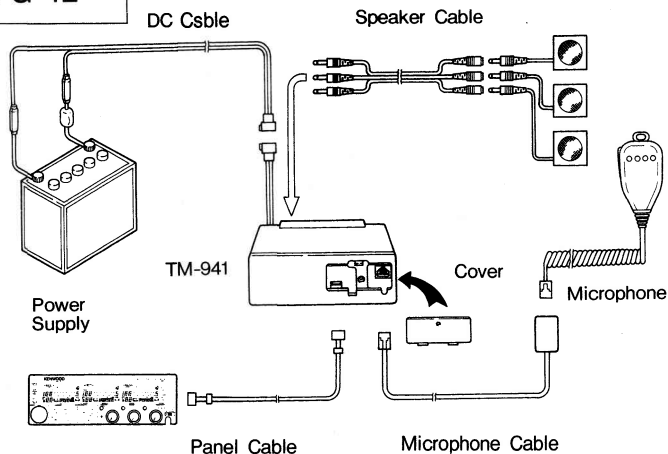

(Fig. 3)

- Remove the cover on the front of the PG-4K/4L front panel, and pass the microphone cable and front panel cable through the opening.(Fig.4)

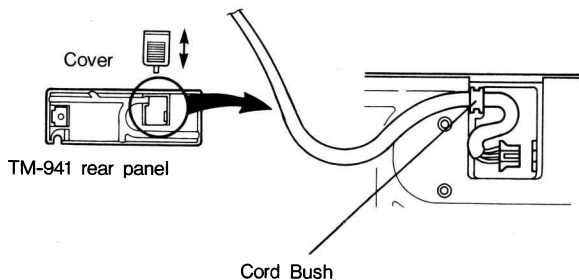
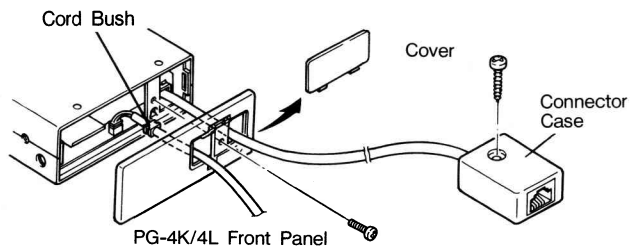

Fig.4

- Connect the PG-4K/4L microphone cable to the microphone connector. Push the connectors together until they click. (Fig.4)

- Attach the PG-4K/4L front panel to the transceiver with a binding screw and replace the cover. (Fig.4)

- Fit the cord bush on the panel cable into the front panel (Fig.5-D), fix the panel cable, and install the cover. (Fig.4-A)

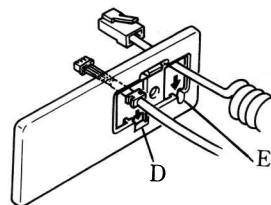

Fig.5

- Connect the microphone to the other connector of the microphone cable. Attach the connector in any convenient position with a screw. (Fig.4-B)

- Slide the small cover off of the front panel unit as shown in the accompanying illustration. Gently lift up on the cable near the grommet to disengage it from the front panel. Then gently pull the cable assembly to left to disconnect the white 4 pin connector. **Push the white connector on the PG-4K/4L to right into the front panel socket.**

NOTE:

The key on the connector should be up, as shown.

Push the grommet down into its slot, and route the cable as desired in the slots on the rear of the front panel. Replace the cover to complete the cabling. (Fig.4-C)

●BRACKET

Loosen the bracket screws and put the two plates at right angles. Attach the front panel unit to the bracket using the three supplied screws.

Install the bracket using the supplied flat washers and screws.

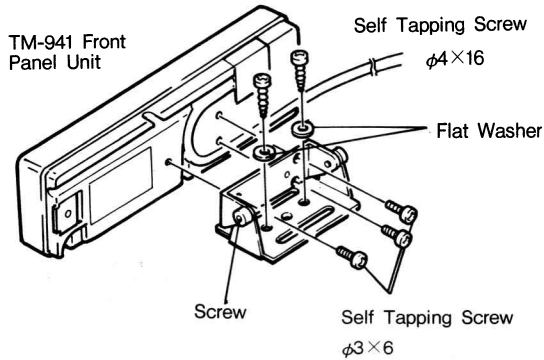

●Installation using Velcro fastener

NOTE

The bracket may come off due to vibration or shock when installed using Velcro. Install the assembly in a safe position near the console, or storage compartment (indicated by the dotted lines) to ensure safety.

Peel the backing on the supplied Velcro tape and attach it to the back of the front panel unit. Securely install the front panel in a stable position.

