

# ICS NAV6 range

User Guide

## Important Information

This equipment is not approved for use by SOLAS convention vessels within the Global Maritime Distress and Safety System (GMDSS)

It is intended for use by leisure craft and other non-SOLAS vessels wishing to participate within GMDSS

## Safety Warnings

Do not use the sensor as a grab-handle

This instrument is for use as an aid to sailors and should not lead to a reduction in the level of good seamanship required at all times  
Reception of messages cannot always be guaranteed as this depends on local radio propagation

The correct magnetic variation must be input at the navigation instruments (e.g. GPS, electronic compass) for the accurate display of COG, set, waypoint bearing and heading.

*The technical data, information and illustrations contained in this publication were to the best of our knowledge correct at the time of going to print. We reserve the right to change specifications, equipment, installation and maintenance instructions without notice as part of our policy of continuous product development and improvement. No part of this publication may be reproduced, stored in a retrieval system or transmitted in any form, electronic or otherwise without permission in writing from McMurdo Limited. No liability can be accepted for any inaccuracies or omissions in the publication, although every care has been taken to make it as complete and accurate as possible.*

Copyright © 2004, McMurdo Limited. All rights reserved.

# Contents

User Guide .....	2
Quick Start.....	2
Introduction.....	3
What Is NAVTEX? .....	3
How Does NAVTEX Work? .....	3
ICS NAV6 Features .....	3
The ICS NAV6 range .....	3
Display Unit .....	4
NAVTEX Sensor.....	4
Advanced Operation.....	12
NAVTEX Mode .....	12
NAVTEX Mode, Message View .....	12
NAVTEX Mode, Print View§ .....	13
NAVTEX Mode, Sort View .....	13
NAVTEX Mode, Filter View .....	14
Navigate Mode§ .....	17
Setup Mode .....	21
Setup Mode, General View, LCD Page .....	21
Setup Mode, General View, Options Page .....	23
Setup Mode, NAVTEX View, Options Page .....	24
Setup Mode, NAVTEX View, Options Page, Print Setup§ .....	25
Setup Mode, NAVTEX View, 518 and 490 Names Pages .....	26
Setup Mode, NAVTEX View, 518 and 490 Names, Station Database Setup .....	26
Setup Mode, NAVTEX View, Monitor Page.....	28
Setup Mode, Navigate View, Options Page§.....	29
Setup Mode, Navigate View, User View Page§.....	29
Setup Mode, Navigate View, Monitor Page§ .....	30
Alarm Operation .....	31
Output to a PC or Plotter§ .....	31
Maintenance and Trouble Shooting.....	32
Cleaning .....	32
Faultfinding ICS NAV6 display .....	32
ICS NAV6hub faultfinding.....	33
User Serviceable Parts.....	34
Software Upgrade.....	34
Fuses.....	34
Specification .....	35
Outline Drawings .....	39
Appendix I: NAVTEX Station Database.....	39
Appendix I: NAVTEX Station Database.....	40
Appendix II: Message Type Indicators .....	43
Appendix VII: ICS NAV6 Menu Navigation .....	44

§ See Page 2 for an explanation of this symbol





Congratulations on purchasing this **ICS NAV6** product. It is not only an excellent NAVTEX receiver, but a first class instrument repeater. It may be the only display you will ever need at your navigation position. We hope that it gives you many years of reliable service. Please take the time to read this manual carefully as it contains some essential information regarding the operation and maintenance of the product and a useful background to the NAVTEX system.

We recommend that you regularly visit the McMurdo product website [www.mcmurdo.co.uk](http://www.mcmurdo.co.uk) for information on updates, the availability of software enhancements, further options and support. The support pages contain frequently asked questions about the ICS NAV6 that you may find useful. There is also a NAVTEX database providing a list of operational NAVTEX stations and their details.

## USER GUIDE

This user guide describes the operation of the ICS NAV6plus, ICS NAV6Aplus, ICS NAV6dual and ICS NAV6repeater equipments.

**Not all the menu features described are provided by the ICS NAV6dual. Where this is the case, the symbol § is used to mark the feature.**

The ICS NAV6repeater will display NAVTEX menu pages only when incorporated with a ICS NAV6 system or ICS NAV6 sensor.

Installation instructions are provided in the separate NAV6 range Installation Guide. Further installation information is furnished separately with each ICS NAV6 ancillary instrument. It is recommended that installation be carried out by a recognised marine installation engineer.

## QUICK START

You will find the NAV6 extremely easy to operate. Please don't be intimidated by the comprehensive nature of this manual. In reality, receiving your first NAVTEX messages could not be simpler.

- Follow the installation guidelines
- Re-check the cable connection
- The ICS NAV6 system has no ON/OFF switch, it will start up as soon as power is applied.
- If you have not connected a GPS navigation receiver, make sure that you set the date and time on the screen which will appear at start up.
- Wait for your first NAVTEX message. If you are within range of a NAVTEX transmitter, you should not need to wait for more than four hours.
- Refer to "Appendix VII: ICS NAV6 Menu Navigation" for an overview of the available operating modes & how they relate to each other.
- Read the "Basic Operation" section to find out how to use some of the commonly used features of this product
- If you then want to get the best from the system, read the rest of the manual!

# INTRODUCTION

## ***What Is NAVTEX?***

NAVTEX is a worldwide system for the broadcast and automatic reception of maritime safety information (MSI) in English by means of a narrow-band direct-printing telegraphy. NAVTEX provides shipping with navigational and meteorological warnings and urgent information.

NAVTEX is an element of the IMO/IHO worldwide Navigational Warning Service (WWNWS) as defined by IMO Assembly Resolution A.706(17). It is included within the Global Maritime Distress and Safety System (GMDSS). Since 1 August 1993, a NAVTEX receiving capability has become mandatory equipment for certain vessels under the provisions of the International Convention for the Safety of Life at Sea (SOLAS).

NAVTEX broadcast information is available to all seafarers, free of charge.

## ***How Does NAVTEX Work?***

NAVTEX transmissions are sent from stations situated worldwide. The power of each transmission is regulated to avoid the possibility of interference between transmitters. Each station is allocated a 10-minute time slot every 4 hours so that many stations can share the same frequency. Stations typically have a transmission range of 250 – 300 Nm.

# ICS NAV6 FEATURES

## ***The ICS NAV6 range***

**ICS NAV6plus** full feature NAVTEX with NMEA repeater instrument displays, includes dual channel NAVTEX sensor with 10m sensor cable.

**ICS NAV6Aplus** full feature dual channel NAVTEX with NMEA repeater instrument displays, supports a wide variety of antenna types such as an insulated backstay wire or active and passive whip antenna systems.

**ICS NAV6dual** dual channel NAVTEX only, includes dual channel NAVTEX sensor with 10m sensor cable.

**ICS NAV6repeater** stand alone NMEA repeater instrument display, can be connected to ICS NAV6plus/Aplus NAVTEX system using a ICS NAV6hub

Feature	ICS	ICS	ICS	ICS
	NAV6dual	NAV6plus	NAV6Aplus	NAV6repeater
Dual receiver	x	x	x	
NMEA Auto station		x	x	
NMEA GPS Display		x	x	x
NMEA instrument display		x	x	x
NMEA Logging		x	x	x
Display backlight	x	x	x	x
Printer / data output		x	x	x
Antenna options			x	

**Note: ICS NAV6dual has no PC or printer interface connection.**

### **Display Unit**

- The Display Unit has a high resolution backlit LCD.
- The display unit contains a large non-volatile memory to store NAVTEX messages.
- Messages can be filtered and sorted.
- The ICS NAV6plus and ICS NAV6Aplus can act as an NMEA instrument repeater and are capable of displaying data in a choice of formats.
- The ICS NAV6plus and ICS NAV6Aplus can be connected to a printer or computer to print NAVTEX messages and Navigation logs.
- Audible and visible alarms can be set up to indicate reception of SAR and/or New Messages.
- A sleep mode allows long standby periods with minimum power consumption, such as when the vessel is left in a marina with main batteries being trickle charged from the shore.

### **NAVTEX Sensor**

- The Sensor Unit contains dual receivers that can receive on both 490kHz and 518kHz simultaneously.
- The ICS NAV6plus and ICS NAV6dual have a dual channel NAVTEX sensor unit.
- ICS NAV6Aplus has the ability to connect to a wide range of remote antenna types by using the NAVTEX Receiver Unit



## BASIC OPERATION

The ICS NAV6 is a flexible & powerful tool for receiving, storing & viewing NAVTEX messages. To assist you in getting the best from your ICS NAV6 equipment, read this section which contains short cuts to the most commonly used NAVTEX operations. Read the rest of the manual for a comprehensive guide to the ICS NAV6 range.

First, find your way around the keypad and the display.

### The Keypad

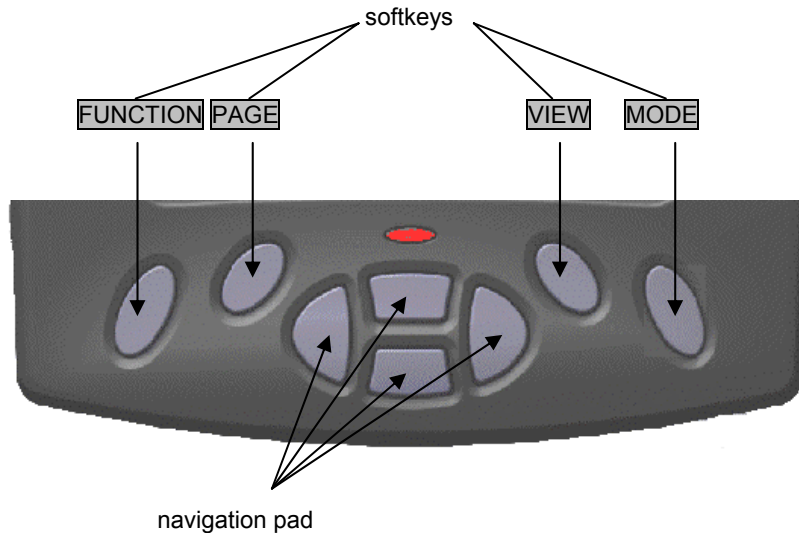

Centre keys are a 'navigation pad' ( **UP** **DOWN** **LEFT** **RIGHT** ).

Softkeys are situated on either side of the navigation pad. The current function is shown on the soft-key menu area at the bottom of the LCD.

The **MODE** softkey switches between the three operating 'modes' (NAVTEX, Navigate & Setup).

The **VIEW** softkey switches between 'views' in each operating 'mode'. If a 'view' has several 'pages' associated with it then these are selected with the page softkey.

Operate the keys in this order to get to the mode that you want:

**MODE** → **VIEW** → **PAGE** → **FUNCTION**

Softkeys are context sensitive and cyclical in operation; several button presses will return you to the start of the cycle. As the button is pressed, the softkey labels change to show the current functions of the keys.

### The Display

At the bottom of the display is the softkey menu area:

The softkey menu area shows what each softkey does in the current operating mode.

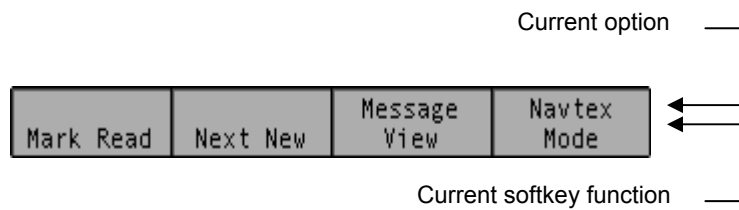

The top line of each softkey menu box indicates the option that is *currently* selected.

The bottom line of each softkey menu box indicates the current function of that softkey.

The example above shows the ICS NAV6 in NAVTEX Mode; the right softkey selects the mode, and current mode is Navtex.

At the top of the display is a status bar:



The status information is displayed as a series of icons. The meaning of the icons is as follows:

IA39	Message identifier for the top message
	An alarm is active
GPS	NMEA / GPS position data available
490	490 kHz reception available
518	518 kHz reception available
RX	Receiving message now
SIG	Signal Carrier, but no message
ERR	Sensor communication fault
SAR	SAR message received
NEW	NEW message received
14:50	UTC Time

### **Viewing & Scrolling Through NAVTEX Messages**

To view NAVTEX messages you must first select the NAVTEX Mode.

Use the right hand softkey to change modes until 'NAVTEX Mode' is visible in the right hand softkey menu box.

You can now use the **UP**, **DOWN**, **LEFT** & **RIGHT** keys to scroll through any previously received messages that already show on the display.

**UP** & **DOWN** keys scroll line by line  
**LEFT** & **RIGHT** keys scroll message by message

The messages currently displayed are a sub-set of all the messages stored in memory. Whether you can see a particular message or not depends upon the current station selection, message filter and age limit settings and the sort order applied (see following sections for details).

#### **Message Storage**

All received NAVTEX messages are stored in the ICS NAV6 regardless of whether you have them selected for viewing or not. The memory size provides enough storage for all messages received in any 72 hour period (in fact much longer). You can even change your mind later and view a message that was received previously but not displayed at the time by simply changing a 'filter preset', message 'filter setting' or 'age limit'.

Messages to be displayed are selected from the ICS NAV6 memory by applying a 'filter preset' and message age limit setting.

After using the ICS NAV6 for a while you may notice that if you receive a particular message more than once there will only ever be one copy in view. The ICS NAV6 stores only the best version of a message. It even attempts to repair corrupted messages by comparing copies of the same message!

#### **Filter Presets**

The messages currently available for viewing are selected from all the messages stored in memory by applying 'Filter View' presets'.

Filter page settings are used to define which messages are in view and which messages are hidden from view.

To view the 'active' filter preset number go to [NAVTEX Mode⇒Filter View]. You will notice that the left hand softkey is labelled **PRESET** and a number from 1 to 5 is visible. This number is the current 'active' filter preset number.

Each of the 5 presets has its own 4 filter pages associated with it (518 Types, 518 Stns, 490 Types & 490 Stns)

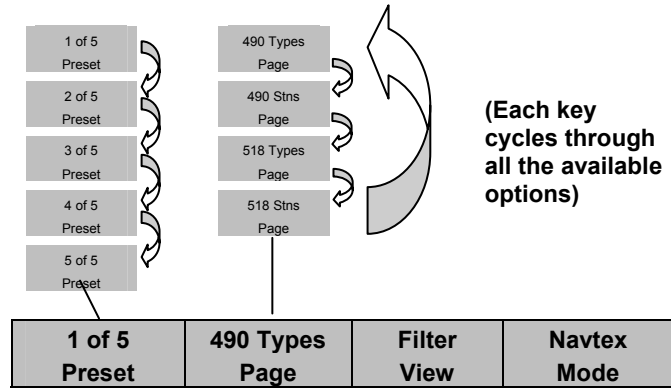

Pressing the **PRESET** softkey changes the active preset number. The filter page settings change as each different preset number is selected. Similarly, the **PAGE** softkey changes the filter pages applicable to the selected preset.

**IT IS MOST IMPORTANT to understand that the 'active preset' is always the filter that is applied to the NAVTEX message display – even when the preset selection is not visible.**

Presets can be used to switch quickly between different sets of messages filter selections. For instance, if you want to show 'weather warnings from all stations in range', you can set up a preset number for that specific display.

*Tip : Start by using 'preset 1' for normal operation, only use the other presets once you are familiar with the way presets work and want to switch quickly between different sets of message selections.*

#### **Station Selection**

If you leave all NAVTEX stations selected for viewing (subject to your current location) you may quickly become overwhelmed with NAVTEX messages.

By filtering out unwanted stations, you can greatly reduce the amount of unnecessary messages that are displayed. Station filtering can be automatic or by manual selection.

Automatic selection can be used if a GPS is connected to the system. The 'in range' stations are then calculated based on the information stored in the station database.

Manual Station selection is used whenever a GPS position fix is unavailable, or can be used to override an automatic selection.

**View the current stations settings.**

Go to [NAVTEX Mode⇒Filter View⇒490 or 518 Stns Page].

Pick the required 'preset number' (use preset 1 if you are just starting for the first time).

Each 'station setting can be changed between On, Off or Auto.

<b>Setting</b>	<b>Operation</b>
On	Messages from station always in view (see note 1)
Off	Messages from station never in view
Auto§	Messages from station only viewed when nearest or in range depending upon setting (see note 1)

Note 1: messages are only displayed if they also fall within the ageing limit, error limit and message category filter settings.

An \* (asterisk) to the right of the station name indicates that the station is currently selected.

**Automatic Station Selection Using GPS**

Many users will just want to display messages from the nearest NAVTEX station, or only from stations that provide information in their cruising area. This is easily achieved by connecting a GPS receiver and letting the ICS NAV6 system automatically make the best selection.

Go to the [NAVTEX Mode⇒Filter View⇒490 or 518 Stns Page].

Select the required 'active preset number' (use preset 1 if you are just starting for the first time).

Use the **LEFT** or **RIGHT** key to move between the 'In Range' or 'Nearest' setting.

Provided all the station names have 'Auto' next to them and the GPS position fix is valid, an asterisk will appear to the right of the currently selected station names.

Ensure that all the stations that you want to view have a asterisk by them.

You can still override an automatic selection by 'forcing' an individual station 'ON or OFF'

To do this, move the cursor over the station name, use the **LEFT** & **RIGHT** cursor keys to change between ON, OFF (or back to AUTO).

You may wish to set your 'home' station to always 'ON' so that you can display its messages even if it is not currently an automatically selected station.

**Note that if a valid GPS position fix becomes unavailable, after a short time delay all 'auto' stations will turn on and remain on until the GPS position returns.**

### **Manual Station Selection**

If no GPS position fix is available or no GPS is connected to the system, you will probably need to manually select or de-select unwanted stations from view.

Go to the [NAVTEX Mode⇒Filter View⇒490 or 518 Stns Page].

Select the required 'active preset number' (use preset 1 if you are just starting for the first time).

- Use the **UP** & **DOWN** keys to move the cursor over the station name.
- Use the **LEFT** & **RIGHT** cursor keys to change between ON, OFF (not AUTO)

### **Message Filtering**

You can further reduce the amount of messages that are displayed by applying filters to the message categories.

Go to the [NAVTEX Mode⇒Filter View⇒490 or 518 Types Page].

- Select the required 'active preset number' (use preset 1 if you are just starting for the first time).

Each message category type can be turned ON or OFF, or made to display NEW messages only by using the **UP**, **DOWN**, **LEFT** & **RIGHT** keys.

### **'New' Messages**

Sometimes it is useful to know which messages have been received since you last looked at the ICS NAV6 display. Whenever a message is received the message header box displays a 'NEW' or 'SAR' icon.

Even if a new message is currently out of view, the status bar at the top of the display will also indicate a 'NEW' icon.

Go to [NAVTEX Mode⇒Message View]

- What was the **PAGE** soft key has changed to a **NEXT NEW** key.
- The left hand softkey is now a **MARK READ** key.

Once you have read the 'NEW' message and want to clear the 'NEW' icon, press **MARK READ**.

The 'NEW' icon will disappear from the message header.

- Press **NEXT NEW** to move on to the next NEW message.
- Once all NEW messages have been marked as read the 'NEW' icon in the status bar at the top of the display will disappear.

### **Hiding 'marked as read' messages from view**

Messages that have been 'marked as read' are still displayed but now without a 'NEW' icon.

If you wish, you can automatically hide 'marked as read' messages from view.

Go to [NAVTEX Mode⇒Filter View⇒490 or 518 Types Page]

- Select the required 'preset number'
- Place the cursor bar over the message categories that you want to hide and change to 'New' instead of 'On'.

**You may wish to leave SAR messages as 'On' so that they are not hidden once read.**

### ***Displaying the Newest Message***

To display the newest message at the top of the display.

Go to [NAVTEX Mode⇒SortView⇒Descending Order⇒Date Criteria].

The newest message is now at the top of the display.

**Caution : Messages are 'date and time' stamped even if there is no GPS connected and therefore no corrected time reference to work from.**

**When you first power up the ICS NAV6, if there is no GPS connected you should manually enter the date and time. From then on the ICS NAV6 will keep time until power is removed from the system.**

**The ICS NAV6 'Calendar & Clock' stops while power is off, consequently the date and time should be checked and if necessary corrected each time the system is powered on.**

**If the correct time and date is not set, messages will still be date stamped in a chronological order but the indicated time of reception will then be wrong.**

### ***Message Ageing***

NAVTEX messages become less relevant over time & eventually may just clutter the display. In order to reduce the number of obsolete NAVTEX messages that are being displayed, the ICS NAV6 uses the concept of a message 'Age Limit'. By setting an age limit it is possible to hide older messages from view.

Go to [Setup Mode⇒NAVTEX View⇒Options Page]

Use the **UP** or **DOWN** key to move the cursor over the age limit setting, the **LEFT** & **RIGHT** keys to select a new value.

3 days is an appropriate age limit to select as most NAVTEX messages have a nominal life of 72 hours.

Set a longer age limit if you want to display NAVTEX messages going back over previous days and weeks.

Remember all messages are still stored in memory for a considerable length of time, consequently increasing the age limit can bring older messages back into view.

## ADVANCED OPERATION

This section provides a detailed description of the 'advanced' operation of your ICS NAV6. The three operating modes are described in detail. Remember to use the right-hand **MODE** softkey to switch between the operating modes.

### NAVTEX MODE

NAVTEX Mode is only available if a sensor is (or has been) connected to the display and the NAVTEX frequency setting on the NAVTEX options page is set to 518 kHz, 490 kHz or Both.

In NAVTEX Mode, the display consists of a large area dedicated to displaying NAVTEX messages, with a status bar at the top, and descriptions of the softkey functions at the bottom.

It is possible to scroll up and down the messages line by line, using the **UP** and **DOWN** keys. Additionally, you can step through the display, message by message using the **LEFT** and **RIGHT** keys.

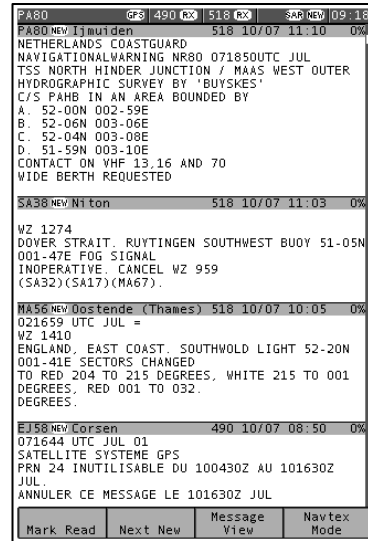

Four different 'views' can be selected by pressing the **VIEW** softkey:

- Message View**
- Print View** (when enabled in setup)
- Sort View**
- Filter View**

### NAVTEX Mode, Message View

Used to view messages. Each new message can be accessed by a single key press & then marked as read, if required.

The **NEXT NEW** softkey should be used to move the next new message to the top of the NAVTEX display, where it can be marked as read by pressing **MARK READ**. Note that the message that will be 'marked as read' is indicated in the top left of the status bar. This is particularly useful when the message's header has scrolled off the top of the display area.



### **NAVTEX Mode, Print View§**

Allows individual messages to be printed. The 'Print View' is only displayed if the manual print setting is enabled on the [Setup Mode⇒NAVTEX View⇒Options Page]. Printing is only possible if an external printer or PC is installed as part of the system.

The **NEXT NEW** softkey can be used to move the next new message to the top of the NAVTEX display where pressing **PRINT** will print it.

### **NAVTEX Mode, Sort View**

From within this view different sort criteria can be applied to change the order of the messages on the display. The NAVTEX Mode display can be sorted in one of three ways by pressing the **CRITERIA** softkey:

**Sort by Station**

**Sort by Type**

**Sort by Date**

The sort can be further organised in ascending or descending order by pressing the **ORDER** softkey.

#### **Sort by Station**

Sorts by station name.

*Ascending* sort is 490 stations A to Z , then 518 stations A to Z.

Messages are ordered by message category A to Z.

*Descending* sort is 518 stations Z to A, then 490 stations Z to A.

Messages are ordered by message category Z to A.

#### **Sort by Type**

Sorts by message category.

*Ascending* sort is 490 message category A to Z before 518 message category A to Z.

*Descending* sort is 518 message category Z to A before 490 message category Z to A.

#### **Sort by Date**

Sorts by time and date of message reception.

*Descending* sort puts the newest message at the top of the display.

*Ascending* sort puts the oldest message at the top of the display.

For sort by date to work properly, the correct time and date should be set using either time data from the NMEA input, or if this is not available, time should be entered manually at start-up.

The scroll bar at the right edge of the display indicates how far you have progressed through the filtered and sorted messages.

The total height of the scroll bar represents the total number of messages

available for viewing with the current filter settings.

The lighter section of the scroll bar represents the messages that are currently visible on the screen.

The vertical position of the scroll bar represents how far through the messages you have scrolled.

### ***NAVTEX Mode, Filter View***

This view allows specific stations to be selected for display and the various message categories to be turned on or off. Use the filter view to select which message types from which stations you wish to see displayed.

#### **Presets**

Using the filter presets allows quick selection of 5 different filter settings. Once a preset is selected, the filter settings for that preset may be changed as required. The filter settings for the active preset will be applied when NAVTEX messages are next viewed.

Press the **PRESET** softkey to select a preset.

Set up the 5 filter presets for the stations and message types that you use most. For example:

- Preset 1 - all message types from nearest station
- Preset 2 - meteorological warnings from nearest station
- Preset 3 - navigational warnings from nearest station
- Preset 4 - new messages of all message types from nearest station
- Preset 5 – new messages of all message types from stations in range)

There are 5 separate Filter View presets. Each preset has its own set of 4 Filter View Pages.

Use the **PAGE** softkey to select one of the four possible filter pages: 518 Stations, 518 Types, 490 Stations, or 490 Types.

### Message Categories

The picture shows the 518 Types filter page; the 490 Types filter page is similar.

Each of the message types can be selected as either On, Off or New

Use the **UP** and **DOWN** keys to select the message type setting that you wish to edit. Use the **LEFT** and **RIGHT** keys to change the setting.

Set each message type filter to one of the following:

Setting	Notes
On	Message type always displayed
Off	Message type never displayed
New	Message type only displayed when new. Messages marked as read will not appear.

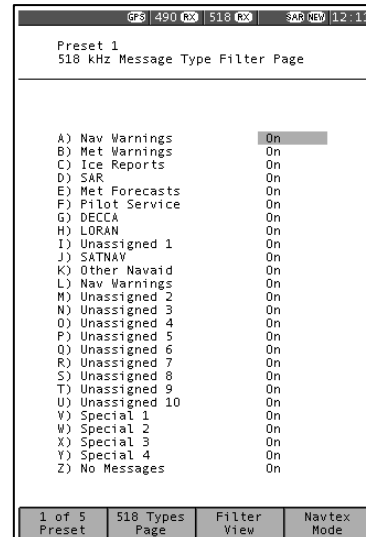

### Stations

The picture shows the 518 Stations filter page; the 490 Stations filter page is similar. Use the **UP** and **DOWN** keys to select the station filter setting that you wish to edit. Use the **LEFT** and **RIGHT** keys to change the setting.

The 'Auto Station Filter' setting can be either Nearest or In Range. This setting is active only when you have a GPS receiver connected to the NMEA input and it applies only to stations set to Auto. To display messages from the nearest station to your current position, set the auto station filter to Nearest.

To display messages from all stations in range of your current position, set the auto station filter to In Range.

An asterisk appears next to all stations for which messages will be displayed.

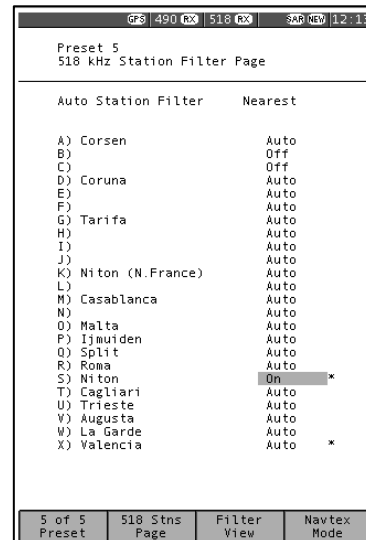

Set the filter for each station to one of the following:

<b>Setting</b>	<b>Notes</b>
On	Messages from station always displayed
Off	Messages from station never displayed
Auto	Messages from station displayed only when nearest or in range depending upon 'Auto Station Filter' setting.

***Important:*** You may wish to leave your ICS NAV6 running whilst your GPS or instrument system is switched off. Be aware that the Navigate data items derived from NMEA (including position) will time out after a short while. If you have chosen to display only the 'nearest' NAVTEX station or stations 'in range' it will revert to displaying all stations that are set to 'Auto'. As soon as the NMEA data becomes available again only the 'Nearest' or 'In Range' stations will be displayed dependant upon your current settings.

## NAVIGATE MODE§

Navigate Mode is only available if there is a GPS or other source of NMEA 0183 data connected to the ICS NAV6 NMEA input.

The GPS icon in the status bar at the top of the display will be illuminated *only* if there is position data available on the NMEA input.

There are five fixed-format Navigate data display views and four user configurable views. These can be selected from within the Navigate Mode using the **VIEW** softkey.

The five fixed views are:

**Position View**  
**Combined View**  
**Waypoint View**  
**Conning View**  
**Log View**

The **User Configurable Views** are User Views 1,2,3 and 4.

*(Tip: Disable views that are not required, in [Setup Mode⇒Navigate ⇒Options Page and Setup Mode⇒Navigate⇒User View Page]. Display units can be changed in the Navigate Options page).*

*Note:* Data fields that are not available on the NMEA input are indicated by a series of dashes (e.g. ---.--).

### **Important**

The correct magnetic variation must be input at the navigation instruments (e.g. GPS, electronic compass) for the accurate display of COG, set, waypoint bearing and heading.

For the purposes of testing your installation, you may wish to use your GPS's simulator mode to generate data for the ICS NAV6. Please check your GPS User Manual to find out whether it transmits valid NMEA data whilst it is in its simulator mode – many GPS's do not set the 'data valid' flag in the NMEA sentences during simulation. As a safety feature, the ICS NAV6 will ignore any NMEA sentences where the 'data valid' flag is not set.

The ICS NAV6 has a built in NMEA simulator mode – please ensure that it is switched OFF in normal operation.

### Position View

The Position View shows GPS information (Position, COG and SOG), Depth reading and Distance log using a large font.

The **UP**, **DOWN**, **LEFT** and **RIGHT** keys have no function.

GPS 490 518 SAR NEW 12:14	
Position 12:14:39 26/07/01 <b>39°36.846N</b> <b>2°39.639E</b>	
SOG	<b>18.5</b> km/h
COG(*T)	<b>035°</b>
Depth	<b>608.9</b> m
Distance	<b>1881.3</b> km
Trip	<b>1855.4</b> km
Position View    Navigate Mode	

### Combined View

The Combined View shows all NMEA input data on one screen using a small font.

The **UP**, **DOWN**, **LEFT** and **RIGHT** keys have no function.

GPS 490 518 SAR NEW 12:16			
Position 39°37.106N 2°39.769E 12:16:23 26/07/01			
SOG	18.5 km/h	Water Speed	15.9 km/h
COG(*T)	035°	Heading(*T)	012°
Turn Rate	-1 °/min	Depth	608.9 m
Wind Speed(R)	10.1 m/s	Wind Direction(*R)	P 043°
Distance	1881.3 km	Trip	1855.4 km
Waypoint		Eddystone	
TTG	03:10:46	54°23.457N 5°57.286W	
Range	22.96 km	BRG(*T)	125°
Closing Speed	7.2 km/h	XTE	P 0.31 km
Combined View		Navigate Mode	

### Waypoint View

The Waypoint View shows waypoint navigation information and a graphical "rolling road" display of the boat position and course relative to the course line. The rolling road display can be used to steer the boat along the course line whilst keeping the cross track error within chosen limits (the XTE limit may be changed on the [Setup mode⇒Navigate View⇒Options Page] ). The Waypoint View shows the waypoint name, waypoint position, time to go (TTG in hours, minutes and seconds), range and bearing to waypoint, closing speed to way point, cross track error and COG and SOG.

The **UP**, **DOWN**, **LEFT** and **RIGHT** keys have no function.

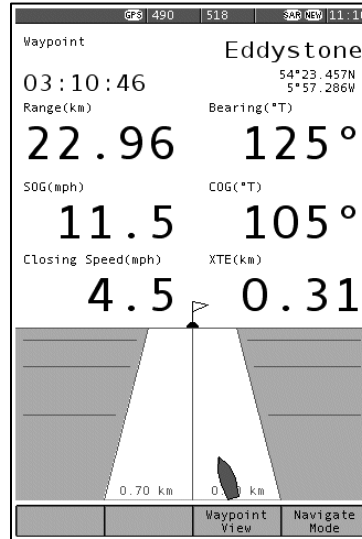

### Conning View

The Conning Display is a unique analogue display which shows overlapping vectors for Heading (course through the water), Course Over the Ground (COG), Set (a combination of leeway and tide) and wind. All these vectors are displayed relative to the current heading, which is displayed in digital form at the top of the screen.

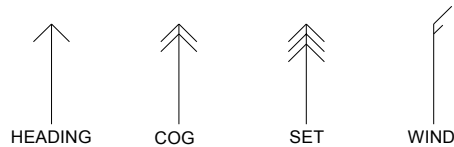

Heading is shown as a single headed arrow.  
 Course Over the Ground (COG) is shown as a double headed arrow.  
 Set is shown as a triple headed arrow - in the familiar manner.

The wind vector displays variable tail patterns according to the strength of the wind. It follows the usual meteorological wind symbol rules: 5kts per half feather, 10kts per full feather, 50kts per triangle. Computed Set and Drift and other related parameters are shown in digital form at the bottom of the screen.

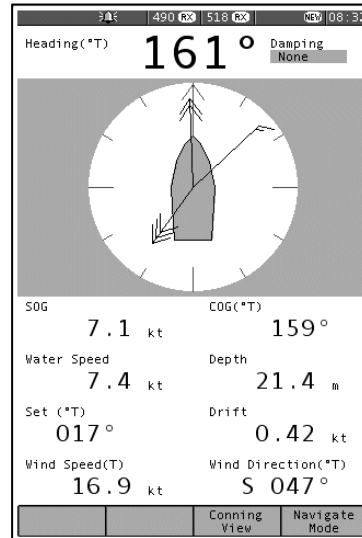

To take into account various sea states, variable damping levels may be selected by pressing the **LEFT** and **RIGHT** arrow keys. The currently selected level is shown in the top right hand corner of the display. The damping level can be None, Low, Medium or High. The damping level affects COG, SOG, Heading and Water Speed and Set and Drift readings. The **UP** and **DOWN** keys have no function.

**Log View**

The **UP** and **DOWN** keys allow the log to be scrolled forwards and backwards in time. The **LEFT** and **RIGHT** keys scroll other LOG data into view.

*(Tip: consider the Log View to be a large piece of paper. The LCD allowing a smaller view which can be moved up, down, left and right displaying a portion of the paper at any one time)*

The Log View columns are Position, COG, SOG, Heading, Water Speed, Wind Direction, Wind Speed, Depth and Distance.

GPS 490 518		SARNEW 11.20	
Time	Position	COG *T	SOG km/h
11/07			
08:30	67°19.546N 016°30.989E	105.4	18.5
08:29	67°19.371N 016°30.901E	105.4	18.5
08:28	67°19.221N 016°30.826E	105.4	18.5
08:27	67°19.146N 016°30.789E	105.4	18.5
08:26	67°18.924N 016°30.677E	105.4	18.5
08:25	67°18.849N 016°30.640E	105.4	18.5
08:21	67°18.179N 016°30.305E	105.4	18.5
08:20	67°18.029N 016°30.230E	105.4	18.5
08:19	67°17.879N 016°30.155E	105.4	18.5
08:18	67°17.729N 016°30.080E	105.4	18.5
08:17	67°17.579N 016°30.005E	105.4	18.5
08:16	67°17.429N 016°29.930E	105.4	18.5
08:15	67°17.279N 016°29.855E	105.4	18.5
08:14	67°17.129N 016°29.780E	105.4	18.5
08:13	67°16.979N 016°29.705E	105.4	18.5
08:12	67°16.829N 016°29.630E	105.4	18.5
08:11	67°16.679N 016°29.555E	105.4	18.5
08:10	67°16.529N 016°29.480E	105.4	18.5
08:09	67°16.379N 016°29.405E	105.4	18.5
08:08	67°16.229N 016°29.330E	105.4	18.5
08:07	67°16.079N 016°29.255E	105.4	18.5
08:06	67°15.929N 016°29.180E	105.4	18.5
08:05	67°15.779N 016°29.105E	105.4	18.5
08:04	67°15.629N 016°29.030E	105.4	18.5
08:03	67°15.479N 016°28.955E	105.4	18.5
08:02	67°15.329N 016°28.880E	105.4	18.5
08:01	67°15.179N 016°28.805E	105.4	18.5
08:00	67°15.029N 016°28.730E	105.4	18.5
07:59	67°14.879N 016°28.655E	105.4	18.5
07:58	67°14.729N 016°28.580E	105.4	18.5
07:57	67°14.579N 016°28.505E	105.4	18.5
07:56	67°14.429N 016°28.430E	105.4	18.5

**User Views**

The four user views can be configured to show either 2,3 or 4 panels (picture shows a 3 panel view). Each panel can be configured to show different navigation information from a range of options. See the [Setup Mode⇒Navigate View⇒User View Page] for more details of the available options.

The **UP**, **DOWN**, **LEFT** and **RIGHT** keys have no function.

GPS 490 518		SARNEW 11.08	
Time			
11:08			
Latitude			
39°57.996N			
Longitude			
2°50.214E			
		User 2 View	Navigate Mode



## SETUP MODE

This mode enables the user to modify the operation of the ICS NAV6.

NAVTEX message display presentation, Navigate data presentation, LCD operation & printing operation are all controlled from Setup Mode.

Setup Mode consists of 3 'Views' that can be selected with the **VIEW** softkey. Each View has a number of 'Pages' that can be selected with the **PAGE** softkey.

General View	NAVTEX View	Navigate View
LCD Page	Options Page	Options Page
Options Page	490 Names Page	User View Page
	518 Names Page	Monitor Page
	Monitor Page	

### Setup Mode, General View, LCD Page

The General View LCD Page shows a chequerboard pattern that can be used to set up the LCD.

LCD contrast is adjusted with the **LEFT** and **RIGHT** keys.

LCD brightness is adjusted with the **UP** and **DOWN** keys.

The **PRESET** softkey is used to store & select the LCD contrast and brightness settings.

Select the LCD setting for Day or Night viewing by pressing **PRESET**.

If 'Day Preset' is visible in the softkey menu area then the contrast and brightness control bars show the current 'Day' settings. These can be changed using the **LEFT**, **RIGHT**, **UP** and **DOWN** keys.

If 'Night Preset' is visible in the softkey menu area then the contrast and brightness control bars show the current 'Night' settings. These can be changed using the **LEFT**, **RIGHT**, **UP** and **DOWN** keys.

Note that the Preset setting that is selected when this page is closed is the one that is selected.

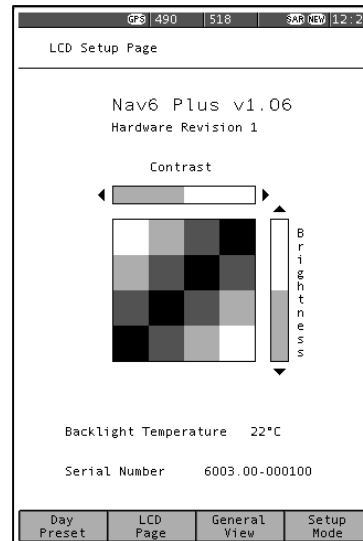

**Sleep Mode**

Selecting the 'Sleep Preset' will turn off the display and reduce power consumption to a minimum. However, NAVTEX message reception continues in the background.

Push any key to restore the display to full operation.

***A short flash of the red LED once every 15 seconds indicates sleep mode is active.***

*(Tip: If the LCD is unreadable due to incorrect contrast setting, hold down the MODE softkey for more than 2 seconds, in any operating mode, to display the LCD page and reset the LCD contrast and backlight to 50%. The LCD should now be readable. Adjust the contrast as required).*

***Note : Reducing the brightness setting to a low level may result in an uneven illumination of the display – this is perfectly normal and not a display fault.***

## Setup Mode, General View, Options Page

Option	Setting	Notes
Year	YYYY	Year, e.g. 2001
Month	MM	Month, e.g. 03
Day	DD	Day, e.g. 15
Hour	HH	24 hour clock
Minute	mm	Minutes
Keyclick	OFF	No beep on key press
	<b>ON</b>	Beep on key press
New Message Alert	OFF	New message alert off
	<b>ON</b>	Audible alarm for new messages
Antenna Alarm	OFF	Antenna alarm off
	<b>Timed</b>	Antenna alarms repeated 5 times, unless cancelled
	Repeated	Antenna alarms repeated until cancelled
SAR Alarm	OFF	SAR alarm off
	<b>Timed</b>	SAR alarms repeated 5 times, unless cancelled
	Repeat	SAR alarms repeated until cancelled
Language	<b>English</b>	English language menus
	Francais	French language menus
	Portugues	Portuguese language menus
	Deutsch	German language menus
	Espanol	Spanish language menus
LED Function	OFF	LED always off
	ON	LED as power indicator
	<b>RX</b>	LED as receive indicator
	SAR	LED as SAR indicator
	NEW	LED as New Message indicator

Defaults shown in BOLD

This view shows general settings for the display such as Date, Time, Sound Alarm and other settings. Use the **UP** and **DOWN** keys to select the setting that you wish to edit. Use the **LEFT** and **RIGHT** keys to change the setting. Date and time will be taken from NMEA input data if available.

Unless NMEA data is available the date and time must be manually set. The date and time is used to mark all incoming NAVTEX messages so that they can be sorted by date and time. There is no battery backup, so date and time will be incorrect when power is switched on.

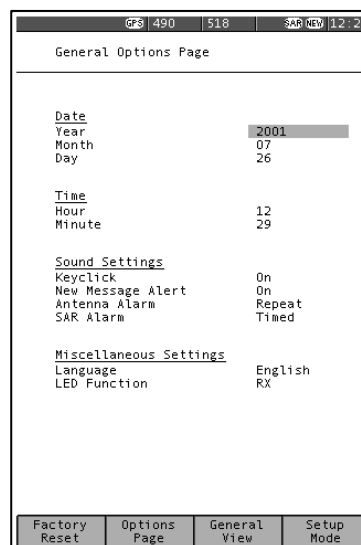

Selecting **FACTORY RESET** will take you to a choice of reset options.

### **Full Reset**

A full factory reset will erase all stored NAVTEX messages and Navigation log data. All menu options will return to the factory default. However, any changes that you have made to the station database will *not* be effected by the full reset.

### **Partial reset**

A partial reset will return all menu options to the factory default. However, any changes that you have made to the station database will *not* be effected by the partial reset.

Should it be necessary to restore the full station database then this requires a reload of the program software using the ICS NAV6 programming kit (ICS Part Number 6100.00)

Contact your supplier for further information.

## **Setup Mode, NAVTEX View, Options Page**

The [Setup Mode⇒NAVTEX View⇒Options Page] shows general settings for NAVTEX operation such as Antenna, Display, Sound and Print settings.

Use the **UP** and **DOWN** keys to select the setting that you wish to edit. Use the **LEFT** and **RIGHT** keys to change the setting.

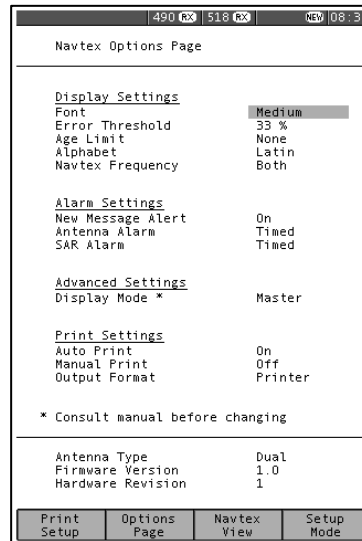

## Setup Mode, NAVTEX View, Options Page, Print Setup\$

Press the **PRINT SETUP** softkey from within the [Setup Mode→NAVTEX View→Options Page] to display the print filter setup pages. Press the **EXIT** softkey to leave the print filter setup.

Note: The print filter setup pages are available only when Auto Print is enabled.

Use the print filter setup pages to select which message types from which stations you wish to have automatically printed when received. The print filtering is independent of the filtering used for the display. It does not affect the storage of messages for display on the NAVTEX screens.

There is a stations and types filter page for each selected receive frequency. Use the **PAGE** softkey to select one of the four possible filter pages: 518 Stations, 518 Types, 490 Stations, or 490 Types.

The graphic shows the 490 Types filter page; the 518 Types filter page is similar.

Each of the message types can be selected as either ON or OFF.

Use the **UP** and **DOWN** keys to select the message type setting that you wish to edit. Use the **LEFT** and **RIGHT** keys to change the setting.

The 'Auto Station Filter' setting can be either Nearest or In Range. The setting is active only when you have a GPS receiver connected to the NMEA input and it applies only to stations set to Auto. To print messages from the nearest station to your current position, set the auto station filter to Nearest. To print messages from all stations in range of your current position, set the auto station filter to In Range. An asterisk appears next to all stations for which messages will be printed.

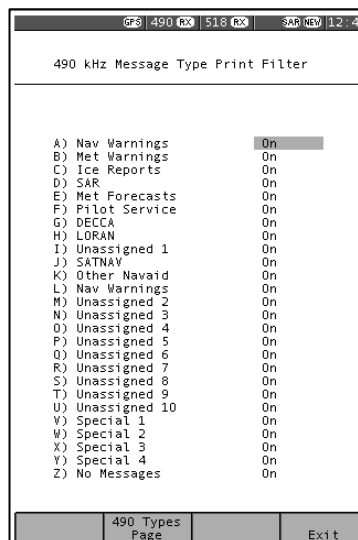

**Note : the GPS must be left on or messages from all stations will be printed, once the GPS position has timed out.**

Set the filter for each station to one of the following:

Setting	Notes
On	Messages from station always printed
Off	Messages from station never printed
Auto\$	Messages from station printed only when nearest or in range depending upon setting.

## Setup Mode, NAVTEX View, 518 and 490 Names Pages

The station names setup pages determine the names of stations displayed on station filter pages and in NAVTEX message headers.

The picture shows the '518 Names' page; the '490 Names' page is similar.

Use the **UP** and **DOWN** keys to select the setting that you wish to edit. Use the **LEFT** and **RIGHT** keys to change the setting.

The Station Name Selection setting allows the user to select between 'GPS' and 'Manual' station selection. If 'GPS' is selected the ICS NAV6 will select the NAVTEX transmitting station name nearest to the boat's current location, but within the same NAV area.

If 'Manual' is selected, then the user can manually select the transmitting station name to be displayed for each station letter.

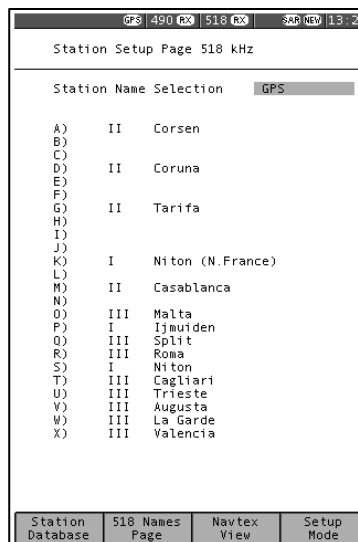

*(Tip : You may be sailing in Nav Area II and therefore will pick station names from Nav Area II. However it is important to realise that the corresponding station letter in the adjacent Nav Areas may be closer. For example, the 'S' station that you are receiving is the 'S' station in an adjacent Nav Area).*

## Setup Mode, NAVTEX View, 518 and 490 Names, Station Database Setup

Press the **STATION DATABASE** softkey from within the [Setup Mode→NAVTEX View→518 or 490 Names Page] to display the station database setup page for 518 or 490 kHz.

Press the **EXIT** softkey to leave the station database setup.

The station database page is divided into two halves. The top half shows a scrolling list of all stations in the database. The bottom half shows details of the current station selected in the station list.

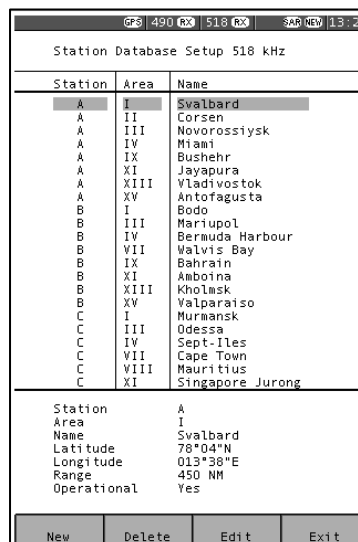

**To edit an existing station entry:**

Use the **UP** and **DOWN** keys to select the station you wish to edit. Use the **LEFT** and **RIGHT** keys to jump to the next or previous station letter in the database.

Press the **EDIT** softkey to edit the station details at the bottom of the display.

The database entry for a typical station (i.e. 'Niton') is shown right.

Station	E
Area	I
Name	Niton
Latitude	50°35'N
Longitude	001°18'W
Range	270 NM
Operational	Yes

Data items are selected using **UP** and **DOWN** keys. Data items are changed using **LEFT** and **RIGHT** keys.

When editing the station name, use the **LEFT** and **RIGHT** keys to change the letters. Use the **NEXT** softkey to accept the current letter and move the cursor to the right. Use the **BACKSPACE** softkey to delete the current letter and move the cursor to the left.

Station	A
Area	II
Name	Corsen
Latitude	48°20'N
Longitude	005°03'W
Range	300 NM
Operational	Yes
Backspace   Next   Save   Cancel	

When editing the latitude and longitude fields, use the **NEXT** softkey to select the Degrees, Minutes or Cardinal part of the position. Use the **LEFT** and **RIGHT** keys to change the selected item.

When you have finished entering the data, press the **SAVE** softkey to save and update the database or **CANCEL** softkey to abort the change.

Field	Notes
Station	The station letter: A to X
Area	The Nav-Area: I to XVI
Name	The station name as displayed on NAVTEX messages. Up to 17 characters.
Latitude Longitude	The transmitter position. Used to determine the nearest and in-range stations
Range	The stated coverage range of the station in NM. Used to determine in range stations.
Operational	Set to YES when the station becomes operational. Set to NO when the station is declared but not yet operational. When set to NO, the station will be excluded when determining the nearest and in range stations.

**To enter a new station:**

Press the **NEW** softkey to create a new database entry. The rules for entering a new station are identical to those described above for editing an existing station. When you have finished entering the data, press the **SAVE** or **CANCEL** softkey as required.

**To delete a station :**

Use the **UP**, **DOWN**, **LEFT** and **RIGHT** keys to select the station in the station list that you wish to delete. Press the **DELETE** softkey. Confirm or cancel the deletion by pressing the **CONFIRM** or **CANCEL** softkeys.

Should it be necessary to restore the full station database then this requires a reload of the program software using the ICS NAV6 programming kit (ICS Part Number 6100.00)  
Contact your supplier for further information.

**Setup Mode, NAVTEX View, Monitor Page**

The monitor page shows a split screen view of live 490 and 518 kHz transmissions as they are received.

None of the filtering selected in the various setup pages is applied.

The monitor page displays ALL incoming data regardless of error rate.

The monitor page also shows the low level phasing characters contained within transmissions (shown as Ø characters) and transmission errors (shown as \* characters).

The two bar graphs display received signal quality (% error count) in real time.

They can be used to good effect when fault finding or checking for the best position to mount a NAVTEX sensor away from any possible sources of interference.

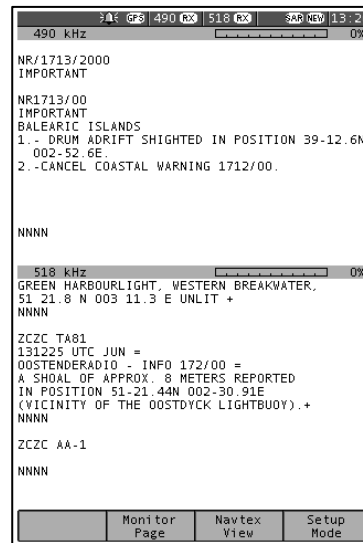



### Setup Mode, Navigate View, Options Page§

The [Setup mode⇒Navigate View⇒ Options Page] shows general settings for the navigation screens such as Display, Waypoint, Log, Print and View settings.

Use the **UP** and **DOWN** keys to select the setting that you wish to edit. Use the **LEFT** and **RIGHT** keys to change the setting.

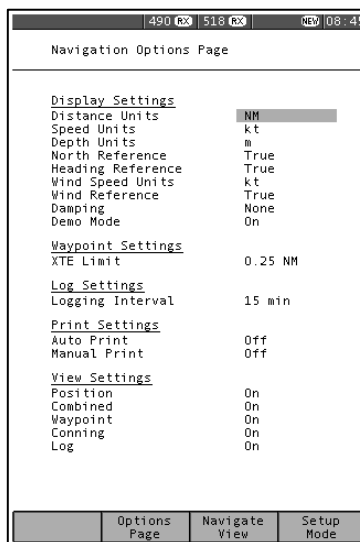

### Setup Mode, Navigate View, User View Page§

The [Setup Mode⇒Navigate View ⇒User View Page] provides settings for the user view pages.

Set the format for each user view page to either Off, 2, 3 or 4 panels.

Set the contents of each panel. Panel 1 is displayed at the top and panel 4 is at the bottom of the page.

Use the **UP** and **DOWN** keys to select the setting that you wish to edit. Use the **LEFT** and **RIGHT** keys to change the setting.

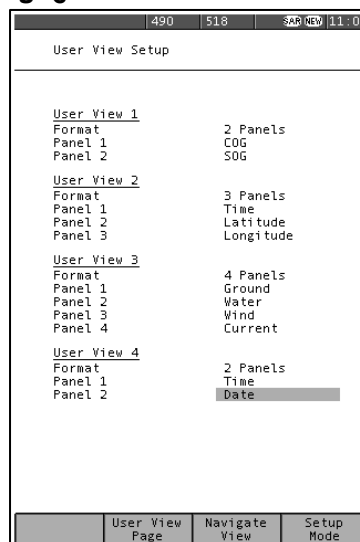

Option	Setting	Notes
Format	<b>Off</b>	Disable the user view page
	2 Panels	Display the user view page with two large panels.
	3 Panels	Display the user view page with one large panel at the top and two small panels at the bottom.
	4 Panels	Display the user view page with four small panels.
Panel n	See right	Choose the data to be displayed in large panels from the following: Time, Date, Position, COG, SOG, Heading, Water Speed, Wind Direction, Wind Speed, Set, Drift, Distance, Trip, Depth, Turn Rate, Waypoint, Wpt Position, Range, Bearing, TTG, Closing Spd, XTE. Choose the data to be displayed in small panels from the following: Time/Date, Latitude, Longitude, Ground, Water, Wind, Current, Odometer, Depth, Turn Rate, Waypoint, Wpt Latitude, Wpt Longitude, Range/Bearing, TTG, Closing Spd, XTE.

Defaults shown in BOLD

### Setup Mode, Navigate View, Monitor Page§

The monitor page shows a view of live NMEA 0183 data received at the NMEA input.

The monitor page displays ALL incoming sentences and can be paused by pressing the **PAUSE** softkey.

GPS	518 ERR	SAR NEW	15:54
\$XXVHW,11.5,T,12.1,M,8.6,N,10.3,K			
\$XXVLW,55011.5,N,1001.8,N			
\$XXHW,315.676,R,10.1,M,A			
\$XXDBT,20.5,f,608.9,M,4.2,F			
\$XXROT,-0.8,A			
\$XXRMB,A,0.17,L,Breakwater,Eddystone,5423.457			
.N,00557.286,W,12.4,124.7,3.9,F			
\$GPRMC,155416.A,4009.741,N,00256.086,E,10.0,3			
5.4,260701.02.2,W*57			
\$GPRMC,A			
\$GPVTG,105.4,T,107.6,M,300.0,280.0,K			
\$GPGGA,155416.4009.741,N,00256.086,W,1.5,01.1			
.002,M,051,M,000.0000			
\$GPGLL,4009.741,N,00256.086,W			
\$XXVHW,11.5,T,12.1,M,8.6,N,10.3,K			
\$XXVLW,55011.5,N,1001.8,N			
\$XXHW,315.676,R,10.1,M,A			
\$XXDBT,20.5,f,608.9,M,4.2,F			
\$XXROT,-0.8,A			
\$XXRMB,A,0.17,L,Breakwater,Eddystone,5423.457			
.N,00557.286,W,12.4,124.7,3.9,F			
\$GPRMC,155417.A,4009.744,N,00256.087,E,10.0,3			
5.4,260701.02.2,W*52			
\$GPRMC,A			
\$GPVTG,105.4,T,107.6,M,300.0,280.0,K			
\$GPGGA,155417.4009.744,N,00256.087,W,1.5,01.1			
.002,M,051,M,000.0000			
\$GPGLL,4009.744,N,00256.087,W			
\$XXVHW,11.5,T,12.1,M,8.6,N,10.3,K			
\$XXVLW,55011.5,N,1001.8,N			
\$XXHW,315.676,R,10.1,M,A			
\$XXDBT,20.5,f,608.9,M,4.2,F			
\$XXROT,-0.8,A			
\$XXRMB,A,0.17,L,Breakwater,Eddystone,5423.457			
.N,00557.286,W,12.4,124.7,3.9,F			
\$GPRMC,1			
Off Pause	Monitor Page	Navigate View	Setup Mode

## ALARM OPERATION

The ICS NAV6 display contains a buzzer that can generate audible alarms for the following conditions:

<b>Option</b>	<b>Notes</b>
New Message Alert	Short beep beep. Not repeated. Indicates reception of a new NAVTEX message.
SAR Alarm	Morse code: Dot dot dot, dash dash dash, dot dot dot.. S.O.S. Repeated every ten seconds. Indicates reception of a message type D, Search And Rescue NAVTEX message.
Antenna Alarm	Short dah dee, dah dee. Repeated every eight seconds. Indicates that there may be a fault with the NAVTEX sensor or the cabling; see the Fault Finding section for more details.

The alarms can be enabled or disabled via the [SETUP MODE, GENERAL VIEW, OPTIONS PAGE]. When enabled, the SAR Alarm and Antenna Alarm can be set to repeat 5 times or to repeat continuously. When an alarm is active, an alarm bell icon will flash on the status bar.

*(Tip: When an alarm is active, pressing any of the softkeys will cancel the alarm. The normal softkey action will not occur).*

The red LED above the softkeys can be set (on the Setup Mode⇒General View⇒Options Page) to flash when there are unread new messages or SAR messages. This can be useful in a noisy environment where audible alarms cannot be easily heard.

Note : All alarms are silenced if the display is put into 'Sleep Mode'. A short flash of the red LED once every 15 seconds indicates sleep mode is active.

## OUTPUT TO A PC OR PLOTTER§

The ICS NAV6 can be set to output NAVTEX messages to a PC or compatible chart plotter. Set the ICS NAV6 as if setting up a printer, but instead of connecting a serial printer, connect the PC or chart plotter.

To test the PC connection, run a terminal application with the serial port set to 4800 baud, 8 data bits, 1 stop bit, no parity and print a NAVTEX message at the ICS NAV6.

Set the NAVTEX output format to "Data"; see Setup Mode⇒NAVTEX View⇒Options Page. This formats the NAVTEX messages for processing by chart plotter applications.

## MAINTENANCE AND TROUBLE SHOOTING

### **Cleaning**

The ICS NAV6 NAVTEX System may be cleaned when necessary by wiping with a cloth dampened with fresh water. Do not use solvents.

### **Faultfinding ICS NAV6 display**

<b>Fault</b>	<b>Possible cause</b>
LCD blank, RED LED On	Green wire connected to 12 V <i>Disconnect green wire – it should not be connected other than for programming</i>
LCD blank, RED LED off	No power <i>Check that 12 V is connected to RED wire and 0 V to its BLACK pair</i>
RED LED flashing with a period of 2 seconds. Display not operating.	Low voltage <i>There is insufficient voltage supplying the display</i>
RED LED flashing with a period of 15 seconds. Display not operating.	Sleep Mode <i>Press any key to activate the display</i>
No NAVTEX messages received (in view)	No NAVTEX channel selected; see 'No 518 or 490 icon on the status line' below. <i>Check you are in range of a NAVTEX station. Check message age limit setting, decreases age limit to bring older messages into view. Check for SIG or ERR on status line; see below. No error icon, refer to Appendix II.</i>
SIG on status line (signal fault)	If this icon appears for short periods – don't worry – it's caused by one or more NAVTEX stations transmitting carrier but no modulation, or by local interference. If this icon persists then you may have a receiver error or interference from nearby equipment. <i>Check for possible causes. Identify the local source of interference by turning off items of equipment (e.g. battery charger) until the SIG icon is cleared</i>
No 518 or 490 icon on the status line (no channel selected)	Check that one or both NAVTEX channels are selected, if it's not possible to select a channel the sensor is unavailable, refer to ERR below.

<b>Fault</b>	<b>Possible cause</b>
ERR on status line (communications error)	No power to Sensor No communications to Sensor <i>Check connections to sensor. Check for 12 V between YELLOW wire and its BLACK pair</i> Display Mode set to "Slave" <i>Always set the 'Display Mode' to "Master" in single display systems.</i> Two or more master displays connected to a sensor <i>Set the 'Display Mode' on one display to master and set all other displays to slave</i>
No GPS indicator on status line	No GPS data on NMEA input. <i>Check the NMEA data connections.</i> <i>Check that the GPS unit is switched on.</i> <i>Check that the GPS unit is set to output compatible NMEA sentences .</i>

### **ICS NAV6hub faultfinding**

The ICS NAV6hub is provided with 3 status LEDs. The one marked 'POWER' on the pcb should always be lit when power is applied to the ICS NAV6hub.

The other 2 LEDs indicate the status of communications on the 2 RS485 ports. Each LED is only ON when a unit (display or sensor) is talking on the other port. The only units that 'talk' are sensors and the 'master' display. The units talk 4 times per second for a very short period each time. Thus the LEDs appear to flash ON for a short time.

<b>LED Status</b>	<b>Indicates</b>	<b>Explanation</b>
POWER LED off	No 12 V to NAV6hub	Fault with power supply Fuse tripped
POWER LED on	12 V connected to NAV6hub	NORMAL OPERATION
PORT1 LED flashing	Communication received on Port1	NORMAL OPERATION There is a sensor OR the master display connected to Port2
PORT2 LED flashing	Communication received on Port2	NORMAL OPERATION There is a sensor OR the master display connected to Port1
Neither LED is flashing	No communication received on either	Check that a display has been set to 'master'

	Port1 or Port2	Check that the master display has been set to '490', '518' or 'Both' receive frequencies Check LK1 & LK2 link settings
One or both LEDs continuously on	Fault condition	Contact the McMurdo Electronics Technical Helpline for assistance

<b>Fault</b>	<b>Possible Causes</b>
'ERR' on the top line of all displays	No sensor connected All displays have been set to 'slave' – one sensor must be set to 'master' More than one display has been set to 'master' RS485_A & RS485_B have been reversed
NAVTEX messages appear to have blocks of 4 or 5 characters missing	The termination has not been set correctly – see section 2.1.4 above More than one display has been set to 'master'
'ERR' on one display but not on all	Connections to that display are incorrect

### **User Serviceable Parts**

There are no user-serviceable parts in the equipment. If a fault develops, the unit must be returned to a dealer, service centre or direct to McMurdo.

### **Software Upgrade**

The ICS NAV6 has FLASH memory based software. This allows it to be upgraded when new software releases are developed. Check our website [www.mcmurdo.co.uk](http://www.mcmurdo.co.uk) for information on new releases.

### **Fuses**

#### **Input**

The ICS NAV6 has a built-in re-settable fuse on its 12 V input. This fuse will trip if the unit draws excessive current. Power must be disconnected from the unit for 10 seconds in order for the fuse to reset.

#### **Sensor Output**

The ICS NAV6 has a built-in re-settable fuse on its sensor output power connector. This fuse will trip if the sensor unit draws excessive current. The sensor unit power must be disconnected for 10 seconds in order for the fuse to reset.

# SPECIFICATION

## ICS NAV6plus/dual NAVTEX Sensor

Simultaneous dual channel (518 kHz and 490 kHz) receiver  
10 m attached connecting cable  
Waterproof to IEC 60945  
Frequency Stability: +/-10 Hz  
RS485 serial data I/O port  
Data decoding in accordance with ITU-R 540-2

### Power

Supplied by display unit

### Physical

Height 200 mm, Width (base)110 mm, Depth (max)155 mm  
Operating Temperature Range: -15 to +55 °C  
Humidity: 0 to 95% non-condensing  
Weight (without cable): 420 g (approx)  
Industry standard 1" 14 tpi threaded base  
Extension Whip (option): length 45 cm/ <sup>3</sup>/<sub>8</sub>" x 24 tpi thread

## ICS NAV6 range Display Unit

Operating Temperature Range: -15 to +55 °C  
Humidity: 0 to 95%  
Weight (without cable): 445 g

### Display type

½VGA (480 x 320 pixels), 6" monochrome LCD with 4 grey levels and CFL backlight

### Controls

4 x function keys, 4 x navigation keys, with LED backlight

### Alarm

Programmable vital message reception acoustic alarm

### Message Storage

Sufficient non-volatile storage for more than 3 days of NAVTEX transmissions under normal operating conditions

### Physical

Height 198 mm, width 138 mm, depth 40 mm

### Mounting

Panel 'instrument' mounting (standard) hole size 102 mm diameter  
'U' bracket on surface mount (optional)

**Connection**

1 metre cable with screw terminal block  
Expanded system connection with ICS NAV6hub

**Environmental**

Inside/outside mounting  
Waterproof to IEC945 (exposed category)  
IEC945 (EMC)  
CE marked.

**Power requirements**

Voltage range 10.8 V to 15.6 V

**Consumption (Typical)**

Backlight full 310 mA (3.8 W at 12 V)  
Backlight off 165 mA (2.0 W at 12 V)  
Sleep mode 115 mA (1.4 W at 12 V)

**NMEA Data input (ICS NAV6plus/Aplus/repeater )**

NMEA input port, meets the electrical requirements of NMEA 0183  
NMEA GPS/Instrument system interface supports NMEA 0183 V2.0 or higher

**Input/output Interface Specification**

Preferred NMEA sentences: RMC, HDT, HDG, VBW, MWV, VLW, DPT, ROT, VDR, RMB and BWC

Minimum recommended NMEA sentences: RMC and RMB

**Data output (ICS NAV6plus/Aplus/repeater only)**

RS232 serial data, supports the printing of vessel 'Log reports' and NAVTEX message text to ICS NAV6printer or a computer system running compatible software

**NMEA logging Interval (ICS NAV6plus/Aplus/repeater only)**

off, 15, 20, 30 mins, 1, 2, 3, 4, 5, 6, 12 hours. 256 log entries

**NMEA Repeater Display (ICS NAV6plus/Aplus/repeater only)**

9 User selectable NMEA instrument and navigation screens

**ICS NAV6Aplus specifications****Power Requirements**

70mA at 12V (supplied by ICS NAV6 display or ICS NAV6hub)

**Antenna input**

1. 50ohm, range 490 - 518 kHz 12 Vdc to feed to power an active antenna is selectable at installation
2. Hi impedance wide range, supports connection of longer than 2 m of insulated wire or whip antenna

**Physical Dimensions**



Height 180 mm, Width 122 mm, Depth 36 mm, Weight 300 g  
Mounting Bulkhead mounting via two self-tapping screws (supplied)

**Connection**

All connections made by 2 part screw terminal

**Environmental**

Not for outside use  
Unit must be mounted below decks in a suitable dry location

**ICS NAV6hub**

**Power Consumption**

20 mA @12 V

**Physical**

Height 180 mm, Width 122 mm, Depth 36 mm, Weight 300 g

**Mounting**

Bulkhead mounting via two self-tapping screws (supplied)  
Cable exits from slot in base of unit

**Connection**

All connections made by screw terminal (cable size 26 to 14 awg)  
Connect to displays and sensors by the cable supplied with those items  
Connect to ancillary equipment by the cable supplied with that equipment

**Environmental**

Not for outside use  
Unit must be mounted below decks in a suitable dry location

**ICS NAV6repeater**

Same as ICS NAV6plus display unit but without NAVTEX features or  
NAVTEX message text output

ICS NAV6repeater can be upgraded to NAVTEX by adding an ICS  
NAV6plus/Aplus NAVTEX sensor

**ICS NAV6dual Display Unit**

**Data input**

NMEA input port, meets the electrical requirements of NMEA 0183

**Input Interface Specification**

Preferred NMEA sentences: RMC (UTC only)

## **ICS NAV6printer**

### **Power**

Voltage range: 10.8 V to 15.6 V

Consumption (Typical)

Standby 125 mA (1.5 W at 12 V)

Printing 210 mA (2.5 W at 12 V)

### **Printer Unit**

Operating Temperature Range: 0 to +40° C

Storage Temperature Range: -20 to +55° C

Humidity: 0 to 95%

Mounting: Below decks

Weight (without cable): 1200 g (approx.)

### **Printer Specification**

Type: Thermal, 40 chars per line

Character Matrix: 7 x 5

Paper Roll: 80 mm wide x 20 m long

Paper Out: Audible alarm

Front Panel: Four push-button switches located under paper load door

### **Controls**

Power ON/OFF

Paper feed

Two menu setup keys

### **Interface Parameters**

serial RS232 compatible, 4800 baud, 8 data bits, 1 stop bit, no parity

**Auto Linefeed** Selectable (Default : OFF)

**Rear Connections** 10 way plug in connector

**Alarms** Paper Out

Low battery supply 9 Vdc

**Mounting** Shelf/bulkhead

FMT-4 panel mount option

# OUTLINE DRAWINGS

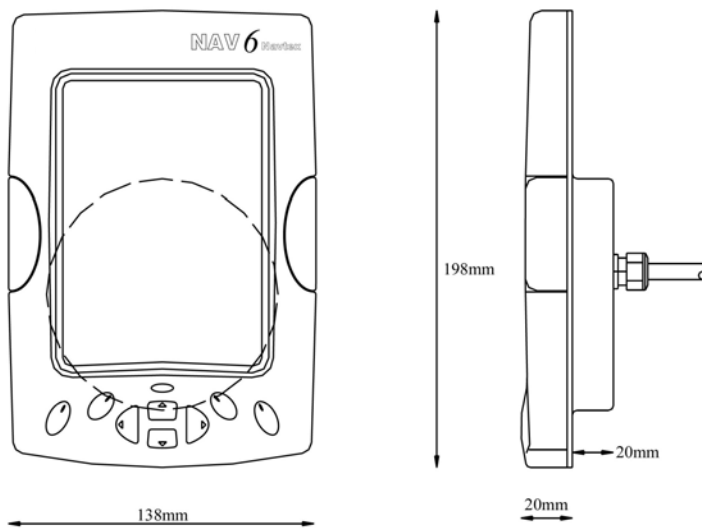
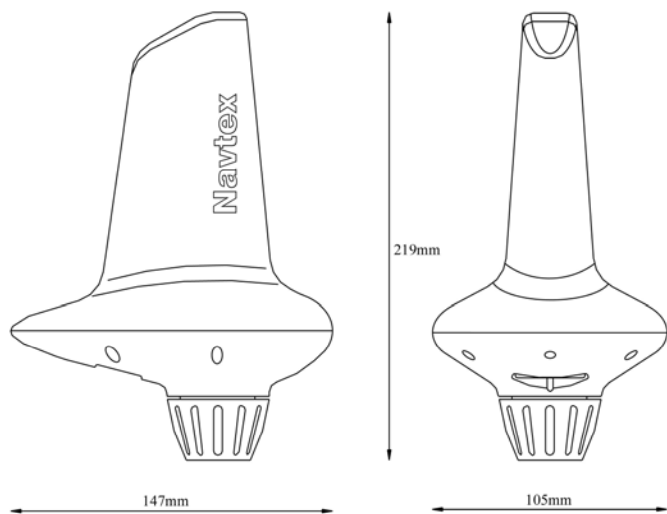

# Appendix I: NAVTEX Station Database

## 518kHz NAVTEX Stations

Id	Area	Country	Name	Latitude	Longitude	Range (NM)	Op
A	01	Norway	Svalbard	78°4'N	13°38'E	450	Yes
A	02	France	Corsen	48°28'N	5°3'W	300	Yes
A	03	Russia	Novorossiysk	44°43'N	37°47'E	300	Yes
A	04	USA	Miami	25°30'N	80°23'W	240	Yes
A	09	Iran	Bushehr	28°58'N	50°50'E	300	Yes
A	11	Indonesia	Jayapura	2°31'S	140°43'E	300	Yes
A	13	Russia	Vladivostok	43°7'N	131°53'E	280	No
A	15	Chile	Antofagusta	23°40'S	70°25'W	300	Yes
B	01	Norway	Bodo	67°16'N	14°23'E	450	Yes
B	03	Ukraine	Mariupol	47°6'N	37°33'E	280	Yes
B	04	Bermuda	Bermuda Harbour	32°23'N	64°41'W	280	Yes
B	07	Namibia	Walvis Bay	23°3'S	14°37'E	380	Yes
B	09	Bahrain	Bahrain	26°9'N	50°28'E	300	Yes
B	11	Indonesia	Amboina	3°42'S	128°12'E	300	Yes
B	13	Russia	Kholmsk	47°2'N	142°3'E	300	Yes
B	15	Chile	Valparaiso	32°48'S	71°29'W	300	Yes
C	01	Russia	Murmansk	68°58'N	33°5'E	140	Yes
C	03	Ukraine	Odessa	46°29'N	30°44'E	280	Yes
C	04	Canada	Sept -Iles	50°11'N	66°7'W	300	Yes
C	07	South Africa	Cape Town	33°41'S	18°43'E	500	Yes
C	08	Mauritius	Mauritius	20°10'S	57°28'E	400	Yes
C	11	Singapore	Singapore	1°20'N	103°42'E	400	Yes
C	12	USA	San Francisco	37°55'N	122°42'W	350	Yes
C	13	Russia	Petropavlosk	53°0'N	158°40'E	280	No
C	15	Chile	Talcahuano	36°42'S	73°6'W	300	Yes
D	01	Sweden	Grimeton	57°6'N	12°23'E	299	Yes
D	02	Spain	Coruna	43°22'N	8°27'W	400	Yes
D	03	Turkey	Istanbul	41°4'N	28°57'E	300	Yes
D	04	Canada	Sept -Iles	50°11'N	66°7'W	300	Yes
D	11	Indonesia	Ujungpandang	5°6'S	119°26'E	300	Yes
D	12	Canada	Prince Rupert	54°18'N	130°25'W	300	Yes
D	13	Russia	Magadan	59°40'N	151°1'E	000	No
D	15	Chile	Puerto Montt	41°29'S	72°57'W	300	Yes
E	01	UK	Niton	50°35'N	1°18'W	270	Yes
E	03	Turkey	Samsun	41°17'N	36°20'E	300	Yes
E	11	Indonesia	Jakarta	6°7'S	106°52'E	300	Yes
E	12	USA	Savannah	32°8'N	81°42'W	200	Yes
E	13	Russia	Beringovskiy	64°10'N	179°02'W	000	No
E	15	Chile	Magallanes	52°56'S	70°54'W	300	Yes
F	01	Russia	Arkhangelsk	64°33'N	40°32'E	300	Yes
F	02	Acores	Horta	38°32'N	28°38'W	640	Yes
F	03	Turkey	Antalya	36°53'N	30°42'E	300	Yes
F	04	USA	Boston (Ice Rep)	41°43'N	70°31'W	200	Yes
F	06	Uruguay	La Paloma	34°40'S	54°9'W	280	Yes
F	09	Iran	Bandar Abbas	27°8'N	57°4'E	300	Yes
F	11	Thailand	Krung Thep	13°44'N	100°34'E	200	Yes
F	13	Russia	Providenia Bukhta	64°10'N	173°10'W	000	No
F	15	Chile	Isla De Pascua	27°9'S	109°25'W	300	Yes
G	01	UK	Cullercoats	55°4'N	1°28'W	270	Yes
G	02	Spain	Tarifa	36°1'N	5°34'W	400	Yes
G	04	USA	New Orleans	29°53'N	89°55'W	200	Yes
G	08	India	Mumbai	19°5'N	72°50'E	299	Yes
G	09	Saudi Arabia	Damman	26°26'N	50°6'E	390	Yes
G	11	Japan	Naha	26°9'N	127°46'E	400	Yes
G	15	Chile	Isla De Pascua	27°9'S	109°25'W	300	Yes
H	01	Sweden	Bjuroklubb	64°28'N	21°36'E	300	Yes
H	03	Greece	Iraklion	35°20'N	25°7'E	280	Yes
H	04	Canada	Prescott	44°20'N	81°10'W	300	Yes

Id	Area	Country	Name	Latitude	Longitude	Range (NM)	Op
H	06	Dutch Antilles	Curacao	12°10'N	68°52'W	250	Yes
H	09	Saudi Arabia	Jeddah	21°23'N	39°11'E	390	Yes
H	11	Japan	Moji	33°52'N	130°36'E	400	Yes
H	12	Canada	Tofino	48°56'N	125°32'W	300	Yes
H	15	Chile	Antofagusta	23°40'S	70°25'W	300	Yes
I	02	Islas Canarias	Las Palmas	28°9'N	15°25'W	400	Yes
I	03	Turkey	Izmir	38°21'N	26°35'E	300	Yes
I	07	South Africa	Port Elizabeth	33°57'S	25°31'E	500	Yes
I	11	Japan	Yokohama	35°22'N	139°36'E	400	Yes
I	15	Chile	Valparaiso	32°48'S	71°29'W	300	Yes
J	01	Sweden	Gislovshammer	55°29'N	14°19'E	300	Yes
J	03	Bulgaria	Varna	43°4'N	27°46'E	350	Yes
J	04	Canada	Sydney	46°11'N	59°54'W	300	Yes
J	11	Japan	Otaru	43°12'N	141°0'E	400	Yes
J	12	Alaska	Kodiak	57°46'N	152°34'W	200	Yes
J	15	Chile	Talcahuano	36°42'S	73°6'W	300	Yes
K	01	UK	Niton (N.France)	50°35'N	1°18'W	270	Yes
K	03	Greece	Kerkyra	39°45'N	19°52'E	280	Yes
K	11	Japan	Kushiro	42°59'N	144°23'E	400	Yes
L	01	Norway	Rogaland	58°39'N	5°36'E	450	Yes
L	03	Greece	Limnos	39°52'N	25°4'E	280	Yes
L	11	Hong Kong	Hong Kong	22°13'N	114°15'E	299	Yes
L	15	Chile	Magallanes	52°56'S	70°54'W	300	Yes
M	01	Belgium	Oostende (Thames)	51°11'N	2°48'E	150	Yes
M	02	Morocco	Casablanca	33°36'N	7°38'W	180	No
M	03	Cyprus	Cyprus	35°10'N	33°26'E	200	Yes
M	06	Argentina	Ushuaia Prefectur	54°48'S	68°18'W	280	Yes
M	09	Oman	Muscat	23°37'N	58°31'E	270	Yes
M	11	China	Sanya	18°14'N	109°30'E	250	Yes
N	01	Norway	Orlandet	63°40'N	9°33'E	450	Yes
N	03	Egypt	El Iskandariya	31°12'N	29°52'E	350	Yes
N	04	USA	Portsmouth	36°44'N	76°1'W	280	Yes
N	06	Argentina	Rio Gallegos	51°37'S	69°3'W	280	Yes
N	11	China	Guangzhou	23°9'N	113°29'E	250	Yes
O	01	UK	Portpatrick	54°51'N	5°7'W	270	Yes
O	03	Malta	Malta	35°49'N	14°32'E	400	Yes
O	04	Canada	St Johns	47°37'N	52°40'W	300	Yes
O	06	Argentina	Comodoro Rivadavi	45°51'S	67°25'W	280	Yes
O	07	South Africa	Durban	29°48'S	30°49'E	500	Yes
O	11	China	Fuzhou	26°2'N	119°18'E	250	Yes
O	12	Hawaiian Islands	Honolulu	21°22'N	158°9'W	350	Yes
P	01	Netherlands	Ijmuiden	52°27'N	4°35'E	110	Yes
P	03	Israel	Hefa	32°49'N	35°0'E	200	Yes
P	04	Canada	Thunder Bay	48°26'N	89°13'W	300	Yes
P	06	Argentina	Bahia Blanca	38°43'S	62°6'W	280	Yes
P	08	India	Madras	13°8'N	80°17'E	299	Yes
P	09	Pakistan	Karachi	24°51'N	67°3'E	400	Yes
P	11	Taiwan	Meilung	23°59'N	121°37'E	350	Yes
P	11	Taiwan	Lintou	23°33'N	119°38'E	350	Yes
P	11	Taiwan	Linyuan	22°29'N	120°25'E	540	Yes
P	11	Taiwan	Keelung	25°8'N	121°45'E	540	Yes
P	11	Vietnam	Hai Phong	20°43'N	106°44'E	400	No
Q	01	Ireland	Malin Head	55°22'N	7°21'W	400	Yes
Q	03	Croatia	Split	43°30'N	16°29'E	085	Yes
Q	04	Canada	Sydney	46°11'N	59°54'W	300	Yes
Q	06	Argentina	Mar Del Plata	38°3'S	57°32'W	280	Yes
Q	11	China	Shanghai	31°7'N	121°33'E	250	Yes
Q	12	USA	Long Beach	35°31'N	121°3'W	350	Yes
R	01	Iceland	Reykjavik	64°5'N	21°51'W	550	Yes
R	02	Portugal	Monsanto	38°44'N	9°11'W	530	Yes
R	03	Italy	Roma	41°48'N	12°31'E	320	Yes
R	04	Greenland	Reykjavik	64°5'N	21°51'W	550	Yes
R	06	Argentina	Buenos Aires	34°27'S	58°37'W	560	Yes

Id	Area	Country	Name	Latitude	Longitude	Range (NM)	Op
R 11		China	Dalian	38°52'N	121°31'E	250	Yes
R 12		Puerto Rico	San Juan	18°28'N	67°4'W	200	Yes
S 04		Canada	Iqaluit	63°44'N	68°33'W	200	No
S 11		Malaysia	Labuan	5°54'N	118°0'E	350	Yes
S 16		Peru	Païta	5°5'S	81°7'W	200	Yes
T 01		Belgium	Oostende	51°11'N	2°48'E	050	Yes
T 03		Italy	Cagliari	39°14'N	9°14'E	320	Yes
T 04		Canada	Iqaluit	63°44'N	68°33'W	200	No
T 11		Malaysia	Kuching	4°27'N	114°1'E	350	Yes
U 01		Estonia	Tallinn	59°30'N	24°30'E	300	Yes
U 03		Italy	Trieste	45°41'N	13°46'E	320	Yes
U 04		Canada	Fundy	43°45'N	66°10'W	300	Yes
U 11		Malaysia	Port Kelang	5°25'N	100°24'E	350	Yes
U 16		Peru	Calleo	12°3'S	77°9'W	200	Yes
V 01		Norway	Vardo	70°22'N	31°6'E	450	Yes
V 03		Italy	Augusta	37°14'N	15°14'E	320	Yes
V 04		Canada	Fundy	43°45'N	66°10'W	300	Yes
V 11		South Korea	Chukpyon	37°3'N	129°26'E	200	Yes
V 11		Mariana Islands	Guam	13°34'N	144°50'E	100	Yes
W 01		Ireland	Valentia (Dublin)	51°27'N	9°49'W	400	Yes
W 03		France	La Garde	43°6'N	5°59'E	250	Yes
W 04		Greenland	Kook Islands	64°4'N	52°1'W	400	No
W 11		Vietnam	Da Nang	16°5'N	108°13'E	400	Yes
W 11		South Korea	Pyonsan	35°36'N	126°29'E	200	Yes
W 12		USA	Astoria	46°10'N	123°49'W	216	Yes
W 16		Peru	Mollendo	17°1'S	72°1'W	200	Yes
X 03		Spain	Valencia	38°43'N	0°9'E	300	Yes
X 04		Canada	Labrador	53°18'N	60°33'W	300	Yes
X 09		Egypt	Serapeum	30°28'N	32°22'E	200	Yes
X 11		Vietnam	Ho Chi Minh-City	10°47'N	106°40'E	400	Yes
X 12		Alaska	Kodiak	57°47'N	152°32'W	200	Yes

## 490kHz NAVTEX Stations

Id	Area	Country	Name	Latitude	Longitude	Range (NM)	Op
A 06		Uruguay	La Paloma	34°40'S	54°9'W	280	Yes
C 01		UK	Portpatrick	54°51'N	5°7'W	270	Yes
E 02		France	Corsen	48°28'N	5°3'W	300	Yes
G 02		Portugal	Monsanto	38°44'N	9°11'W	530	Yes
I 01		UK	Niton	50°35'N	1°18'W	270	Yes
J 02		Acores	Horta	38°32'N	28°38'W	640	Yes
J 11		South Korea	Chukpyon	37°3'N	129°26'E	200	Yes
K 11		South Korea	Pyonsan	35°36'N	126°29'E	200	Yes
S 03		France	La Garde	43°6'N	5°59'E	250	Yes
S 04		Canada	Iqaluit	63°44'N	68°33'W	200	No
T 01		UK	Niton (N. France)	50°35'N	1°18'W	270	Yes
U 01		UK	Cullercoats	55°4'N	1°28'W	270	Yes
W 11		Vietnam	Hai Phong	20°43'N	106°44'E	400	No

Note: to the best of our knowledge, all NAVTEX station database information was correct on the date of publication. Please check our website [www.mcmurdo.co.uk](http://www.mcmurdo.co.uk) for information on updates to the station database.

## APPENDIX II: MESSAGE TYPE INDICATORS

NAVTEX broadcasts use following message type letter:

A	Navigational warnings
B	Meteorological warnings
C	Ice reports
D	Search and rescue information, and pirate warnings
E	Meteorological forecasts
F	Pilot service messages
G	DECCA messages
H	LORAN messages
I	OMEGA messages (Note: OMEGA has been discontinued)
J	SATNAV messages (i.e. GPS or GLONASS)
L	Navigational warnings - additional to letter A
V	Notice to Fishermen (U.S. only)
W	Environmental (U.S. only)
X	Special services - allocation by IMO NAVTEX Panel
Y	Special services - allocation by IMO NAVTEX Panel
Z	No message on hand

# APPENDIX VII: ICS NAV6 MENU NAVIGATION

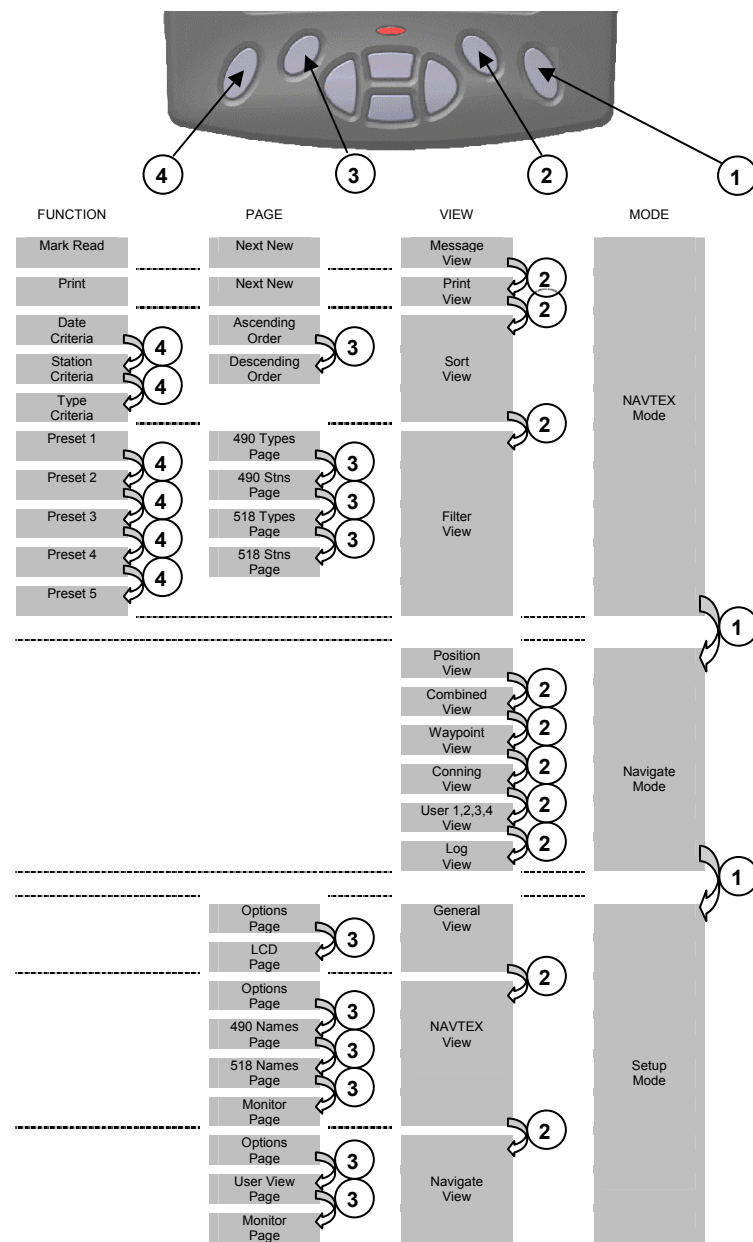



# EC DECLARATION OF CONFORMITY

The following products comply with the EU Directive 1999/5/EC (Radio Equipment and Telecommunication Terminal Equipment) and satisfy all the technical regulations applicable. The Conformity Assessment procedure has been carried out in accordance with Annex IV of the above Directive.

## Products covered by this Declaration

Product Type: **NAVTEX receiver**

Models: **NAV6plus, NAV6Aplus,  
NAV6dual, NAV6repeater**

## Intended usage of products

Intended for use by leisure craft and other non-SOLAS vessels wishing to participate within GMDSS

This product described above complies with the essential requirements in Articles 3.1(a), 3.1(b) and 3.2 of the R & TTE Directive, but is not compliant with Article 3.3(e)

We declare that this product has been tested to all essential test suites, and has been shown to comply with the essential requirements of the R & TTE Directive. The following conformity mark will be applied to the products which fall within Class 1.7 Receive-only Radio Equipment.



On behalf of McMurdo Ltd.

Signed :



Name: **C P Hoffman**  
Title: **Technical Director**

Date: **28 APRIL 2003**

Technical Construction File submitted by ICS Electronics Ltd  
Held by McMurdo Limited,  
Silver Point, Airport Service Road, Portsmouth PO3 5PB, UK

Notified Body consulted: QinetiQ – No. 0191  
Address: Lively Road, Farnborough, Hants GU14 0LX, UK  
Statement of Opinion: DERA-RTTE-56/01-01  
Dated: 13 December 2001

Radio Test Suite and standards applied:  
Limited testing to EN 300 065  
Relevant EMC testing to EN 60945

**ATTENTION**

The attention of the specifier, purchaser, installer, or user is drawn to special measures and limitations to use which must be observed when the product is taken into service to maintain compliance with the above directive. Details of these special methods and limitations to use are available on request, and are also contained in the product owner manuals.



30-101 Iss1

BS EN ISO 9001, BS9000/CECC and CAA Approved  
Registered in England No. 746603  
Registered Office: 1645 Parkway, Whiteley, Fareham, Hampshire, PO15 7AH  
VAT No: GB 421 1393 92



Page 2 of 2

## USER NOTES

**30-100 Issue 1**