

DEPARTMENT OF THE ARMY TECHNICAL MANUAL

ANTENNA GROUPS

AN/GRA-4

AND

AN/GRA-12

This copy is a reprint which includes current pages from Changes 1 through 3

WARNING

DANGEROUS VOLTAGES EXIST ON THE ANTENNA WHEN IN OPERATION

Before working on any part of the antenna, be certain that all power has been turned off.

DON'T TAKE CHANCES!

DEPARTMENT OF THE ARMY TECHNICAL MANUAL
DEPARTMENT OF THE AIR FORCE TECHNICAL ORDER
ANTENNA GROUPS AN/GRA-4 AND AN/GRA-12

TECHNICAL MANUAL
No. 11-2651
TECHNICAL ORDER
No. 31R2-2GRA-101



DEPARTMENTS OF THE ARMY
AND THE AIR FORCE

WASHINGTON 25, D.C., 19 April 1961

TM 11-2651, 1 November 1956, is changed as follows:

Page 3. Add the following to paragraph 2c:

- (3) *Comments or suggestions.* Any comments concerning omissions and discrepancies in appendix I and II will be prepared on DA Form 2028 and forwarded direct to Commanding Officer, U.S. Army Signal Materiel Support Agency. ATTN: SIGMS-ML, Fort Monmouth, N.J.

Page 58. Add the following appendixes:

APPENDIX I
MAINTENANCE ALLOCATION CHART
FOR
ANTENNA GROUP AN/GRA-4
Section I. INTRODUCTION

1. General

a. This section assigns maintenance functions and repair operations to be performed by the lowest appropriate maintenance echelon.

b. The columns are as follows:

- (1) *Part or component.* This column shows only the nomenclature or standard item name. Additional descriptive data is included only where clarification is necessary to identify the part. Components and parts comprising a major end item are listed alphabetically. Assemblies and subassemblies are in alphabetical sequence with their components listed alphabetically immediately below the assembly listing.

*The changes supersede so much of Department of the Army supply manual SIG 7 & 8 AN/GRA-4, 25 September 1957, as pertains to first echelon items.

- (2) *Maintenance function.* This column indicates the various maintenance functions allocated to the echelon capable of performing the operations.
- (a) *Service.* To clean, to preserve, and to replenish fuel and lubricants.
 - (b) *Adjust.* To regulate periodically to prevent malfunction.
 - (e) *Inspect.* To verify serviceability and to detect incipient electrical or mechanical failure by scrutiny.
 - (d) *Test.* To verify serviceability and to detect incipient electrical or mechanical failure by use of special equipment such as gages, meters, etc.
 - (e) *Replace.* To substitute service assemblies, subassemblies, and parts for unserviceable components.
 - (f) *Repair.* To restore an item to serviceable condition through correction of a specific failure or unserviceable condition. This function includes but is not limited to, inspecting, cleaning, preserving, adjusting, replacing, welding, riveting, and straightening.
 - (g) *Aline.* To adjust two or more components of an electrical system so that their functions are properly synchronized.
 - (h) *Calibrate.* To determine, check, or rectify the graduation of an instrument, weapon, or weapons system, or components of a weapons system.
 - (i) *Rebuild.* To restore an item to a standard as near as possible to original or new condition in appearance, performance, and life expectancy. This is accomplished through the maintenance technique of complete disassembly of the item, inspection of all parts or components, repair or replacement of worn or unserviceable elements using original manufacturing tolerances and/or specifications and subsequent reassembly of the item.
 - (j) *Overhaul.* To restore an item to completely serviceable condition as prescribed by serviceability standards developed and published by heads of technical services. This is accomplished through employment of the technique of Inspect and Repair Only as Necessary (IROAN). Maximum utilization of diagnostic and test equipment is combined with minimum disassembly of the item during the overhaul process.
- (3) *1st, 2d, 3d, 4th, and 5th echelon.* The symbol X indicates the echelon responsible for performing that particular maintenance operation, but does not necessarily indicate that repair parts will be stocked at that level. Echelons higher than the echelon marked by X are authorized to perform the indicated operation.

- (4) *Tools required.* This column indicates codes assigned to each individual tool equipment, test equipment, and maintenance equipment referenced. The grouping of codes in this column of the maintenance allocation chart indicates the tool, test, and maintenance equipment required to perform the maintenance function.
- (5) *Remarks.* Entries in this column will be utilized when necessary to clarify any of the data cited in the preceding columns.

c. Columns in the allocation of tools for maintenance functions are as follows:

- (1) Tools required for maintenance functions. This column lists tools, test, and maintenance equipment required to perform the maintenance functions.
- (2) *1st, 2d, 3d, 4th, and 5th echelon.* The dagger (†) symbol indicates the echelons allocated the facility.
- (3) Tool code. This column lists the tool code assigned.

2. Mounting Hardware

The basic entries of the maintenance allocation chart do not include mounting hardware such as screws, nuts, bolts, washers, brackets, clamps, etc.

3. Maintenance by Using Organizations

When this equipment is used by signal services organizations organic to theater headquarters or communication zones to provide theater communications, those maintenance functions allocated up to and including fourth echelon are authorized to the organization operating this equipment.

Section II. MAINTENANCE ALLOCATION CHART

Parts or component (1)	Maintenance function (2)	1 st ech. (3)	2 nd ech. (4)	3 rd ech. (5)	4 th ech. (6)	5 th ech. (7)	Tools required (8)	Remarks (9)
ANTENNA GROUP AN/GRA-4	service		X					No facilities req'd
.....	inspect		x				1	
.....				x			2	
.....	test		x				1, 3	
.....				X			2, 3	
.....	replace		x					
.....	repair				X		2	
.....	rebuild				X			
ANTENNA AS-244/GRA-4	replace		X					
BAG	replace		X					
BLOCK, TACKLE	replace		X					
BOX, CONNECTOR	replace			X				
CABLE	replace			X				
CAP	replace		X					
CAPACITOR.....	replace			X				
CLAMP	replace		X					
CONNECTORS	replace			X				
COUPLING	replace		X					
HANDLE	replace		X					
HOOK	replace		X					
INSULATORS.....	replace			X				
LAMP	replace	X						
LENS, INDICATOR LIGHT	replace		X					
LIGHT, INDICATOR.....	replace			X				

Parts or component (1)	Maintenance function (2)	1 st ech. (3)	2 nd ech. (4)	3 rd ech. (5)	4 th ech. (6)	5 th ech. (7)	Tools required (8)	Remarks (9)
PACKING PREFORMED	replace			X				
POST, BINDING	replace			X				
REEL, WIRE	replace		X					
ROPE	replace		X					
SLEEVE.....	replace			X				
SLING, HOISTING	replace		X					
SLING, CARRYING	replace		X					
TAPE, MEASURING	replace		X					
TOOL, ALIGNMENT	replace		X					
TUNER, ANTENNA	replace		X					
	rebuild					X		
WASHER	replace		X					
WIRE	replace		X					
MAST BASE AB-86/GRA-4	replace		X					Separate MAC.
REEL RL-122/GRA	replace		X					Separate MAC.

Section III. ALLOCATION OF TOOLS FOR MAINTENANCE FUNCTIONS

Tool required for maintenance functions (1)	2d ech (3)	3d ech (4)	4th ech (5)	5th ech (6)	Tool (7)
TOOL EQUIPMENT TE-41	(t)				1
TOOL EQUIPMENT TE-113 2		(t)	(t)	(t)	2
MULTIMETER TS-352/U	(t)	(t)	(t)	(t)	3

**APPENDIX II
BASIC ISSUE ITEMS LIST FOR ANTENNA
GROUP AN/GRA-4**

Section I. INTRODUCTION

1. Scope

a. This appendix lists items supplied for initial operation. The list includes tools, parts, and material issued as part of the major end item. The list includes all items authorized for basic operator maintenance of the equipment. End items of equipment are issued on the basis of allowances prescribed in equipment authorization tables and other documents that are a basis for requisitioning.

b. Columns are as follows:

- (1) *Source, maintenance, and recoverability code.* Not used.
- (2) *Federal stock number.* This column lists the 11-digit Federal stock number.
- (3) *Designation by model.* Not used.
- (4) *Description.* Nomenclature or the standard item name and brief identifying data for each item are listed in this column. When requisitioning, enter the nomenclature and description.
- (5) *Unit of issue.* The unit of issue is the supply term by which the individual item is counted for procurement, storage, requisitioning, allowances, and issue purposes.
- (6) *Expandability.* Expendable items are indicated by the letter X; nonexpendable items are indicated by NX.
- (7) *Quantity authorized.* Under "Items Comprising an Operable Equipment", the column lists the quantity of items supplied for the initial operation of the equipment.
- (8) *Illustration.* Not used.

2. References

Additional instructions concerning maintenance of this equipment are contained in TM 11-5895-229-12P, (Operator and Organizational Maintenance Repair Parts and Special Tool Lists and Maintenance Allocation Chart: Mast AB-86/GRA-4.

Section II. FUNCTIONAL PARTS LIST

Federal stock No.	Description	Unit of issue	Expand-ability	Quan-tity author-ized
(2)	(4)	(5)	(6)	(7)
5820-244-5147	ITEMS COMPRISING AN OPERABLE EQUIPMENT ANTENNA GROUP AN/GRA-4 ANTENNA GROUP AN/GRA-4: provides several ant types for freq of 1.5 to 18.0 mc; J and H Smith part/dwg No. 100.	ea	NX	
Ord thru AGC	TECHNICAL MANUAL: TM 11-2651	ea	X	2
5820-264-7506	ANTENNA AS-244/GRA-4: 1.5 to 18.0 mc freq range; wire construction, for receiver and transmitter signals.	ea	NX	1
5820-497-9628	ANTENNA AS-244/GRA-4 BAG, BG-102, BG-102A, C	ea	X	1
5995-247-9759	CORD CG-357/U: (50 ft 6 in) uses RG-59A/U cable; SigC dwg No. SC-D-34932.	ea	X	6
5970-405-8223	INSULATOR IL-4/GRA-4: with RF Receptacle UG-58/U.	ea	X	1
6240-223-9100	LAMP, GLOW: 105-120 V, 1/25 w, 0.003 amp; miniature bayonet base, 1/8 in. max o/a, h; GE type No. NE-51.	ea	X	1
5985-497-8765	REEL RL-122/GRA-4	ea	NX	2
5985-228-8064	SLING, HOISTING: Halyard MX-516/GR-A.	ea	X	1
5210-265-7451	TAPE, MEASURING: 100 ft lg extended; Justus Roe Model No. 400-A1.	ea	NX	1
5120-408-1701	TOOL, ALINEMENT: approx. 5/32 in. x 1/32 in. thk sedr nib in one end, 6 in. lg x 7/32 in. dia; Amer Rad Hdwe No. 860.	ea	X	1
5985-355-8024	TUNER, ANTENNA: Antenna Tuner TN-174/GRA-4.	ea	X	1
5985-257-2927	MAST AB-86/GRA-4: sectionalized construction; J and H Smith part No. 100-B.	ea	NX	1
	RUNNING SPARES AND ACCESSORY ITEMS			
	ANTENNA GROUP AN/GRA-4 NO PARTS AUTHORIZED FOR STOCKAGE AT FIRST ECHELON			

By Order of the Secretaries of the Army and the Air Force:

Official:

R. V. LEE,
*Major General, United States Army,
The Adjutant General.*

G. H. DECKER,
*General, United States Army,
Chief of Staff.*

Official:

R. J. PUGH,
*Colonel, United States Air Force,
Director of Administrative Service.*

CURTIS E. LeMAY,
Chief of Staff, United States Air Force.

Distribution:

Active Army: To be distributed in accordance with DA Form 12-7 requirements for TM 11-series (Unclas) plus the following:

USASA (2)	11-16
CNGB (1)	11-55
Tech Stf, DA (1) except	11-57
CsigO (18)	11-96
DASA (5)	11-97
ARADCOM (2)	11-98
ARADCOM Rgn (2)	11-117
MDW (2)	11-500 (AA-AE, RA-RT) (4)
Seventh USA (2)	11-555
EUSA (2)	11-557
Corps (2)	11-587
Div (2)	11-592
Units organized under following	11-597
TOE's (2 copies to each	17-51
unless otherwise indicated):	29-56
1-7	30-15
1-17	30-22
1-37	30-500 (AA-AK)
1-67	32-57
1-107	39-61
5-15	44-35
5-16	44-36
5-17	44-235
5-237	44-236
5-278	44-237
7-52	44-435
8-76	44-436
8-78	44-437
8-137	44-445
9-47	44-446
9-65	44-447
9-75	44-448
9-87	44-535
9-117	44-536
9-227	44-537
9-500 (AA-AC)	44-544
9-510 (AA-AC)	44-545
10-22	44-546
10-202	44-547
10-206	44-548
10-377	55-11
10-445	55-12
10-448	55-16
10-536	55-56
11-5	55-57
11-7	55-116

NG: None.

USAR: None.

For explanation of abbreviation used, see AR 320-50.

ANTENNA GROUPS AN/GRA-4 AND AN/GRA-12

CHANGE }
No. 2 }

HEADQUARTERS
DEPARTMENT OF THE ARMY
WASHINGTON D. C., 16 October 1963

TM 11-2651, 1 November 1966, is changed as follows:

Note. The parenthetical references to a previous change (example "page 1 of C1") indicates that pertinent material was published in that change.

Page 3. Delete paragraph 1 and substitute:

1. Scope

This manual describes Antenna Groups AN/GRA- and AN/ GRA-12 and covers their installation, operation, theory, operator's maintenance, and second echelon maintenance. It also includes instructions for performing preventive and periodic maintenance services and repair functions to be accomplished by the organizational repairman.

Add paragraph 1.1 after paragraph 1.

1.1. Index of Publications

Refer to the latest issue of DA Pam 310-4 to determine whether there are new editions, changes, or additional publications pertaining to the equipment. DA Pam 310-4 is an index of current technical manuals, technical bulletins, supply bulletins, lubrication orders, and modification work orders available through publications supply channels. The index lists the individual parts (-10, -20, -35P, etc.) and the latest changes to and revisions of each equipment publication.

Delete paragraph 2 (page 1 of C1) and substitute:

2. Forms and Records

a. Reports of Maintenance and Unsatisfactory Equipment. Use equipment forms and records in accordance with instructions in TM 38-750.

b. Report of Damaged or Improper Shipment. Fill out and forward DD Form 6 (Report of Damaged or Improper Shipment) "s prescribed in AR 700-58 (Army), NAVSANDA Publication 378 (Navy), and AFR 71-4 (Air Force).

TAGO 6513B

c. *Reporting of Equipment Manual Improvements.* The direct reporting by the individual user of errors, omissions, and recommendations for improving this manual is authorized and encouraged. DA Form 2028 (Recommended changes to DA technical manual parts lists or supply manual 7, 8, or 9) will be used for reporting these improvements. This form will be completed in triplicate using pencil, pen, or typewriter. The original and one copy will be forwarded direct to: Commanding Officer, U.S. Army Electronics Materiel Support Agency, ATTN: SELMS-MP, Fort Monmouth, New Jersey 07703. One information copy will be furnished to the individual's immediate supervisor (e.g., officer, noncommissioned officer, supervisor, etc.).

Page 5, paragraph 5b: Delete note 2 and substitute:

2. This listing is based on the original shipment by the contractor. For the current official listing of components of individual models, see the basic issue items list (app. III).

Page 23. Delete paragraph 14d and substitute:

d. *Checking Unpacked Equipment.*

- (1) Inspect the equipment for damage incurred during shipment. If the equipment has been damaged, report the damage on DD Form 6 (par. 2).
- (2) Check the equipment against the master packing list. When no packing list accompanies the equipment, check the equipment against the table of components in paragraph 5. Report all discrepancies in accordance with instructions in TM 38-750 (par. 2).

Note

Shortage of a minor assembly or part that does not effect proper functioning of the equipment should not prevent use of the equipment.

- (3) If the equipment has been used or reconditioned, see whether it has been changed by a Modification Work Order (MWO). The current MWO's applicable to the equipment are listed in DA Pam 310-4 (par. 1.1).

Page 27. Make the following changes:

Paragraph 16f. Add subparagraph g after subparagraph f.

g. After the mast has been raised, bring the guys to the correct tension. Tension must be applied at a uniform rate to prevent twisting the mast. To adjust guy tension, tighten two guys simultaneously, first on one side of the mast and then on the other side of the mast. Increase the tension gradually and evenly until the guys are brought under proper tension.

AGO 6513B

CHAPTER 3

MAINTENANCE INSTRUCTIONS

Delete the note immediately after the chapter heading.
Delete paragraphs 21 through 24 and substitute:

21. Scope of Maintenance

The maintenance duties assigned to the operator of the equipment are listed below together with a reference to the paragraphs covering the specific maintenance functions. These procedures do not require special tools or test equipment.

- a. Daily preventive maintenance checks and services (par. 24).
- b. Cleaning (par. 24.1).
- c. Replacement of defective pilot lamp (par. 30).

22. Preventive Maintenance

Preventive maintenance is the systematic care, servicing, and inspection of equipment to prevent the occurrence of trouble, to reduce downtime, and to assure that the equipment is serviceable.

a. *Systematic Care.* The procedures given in paragraphs 24 and 24.1 cover routine systematic care and cleaning essential to proper upkeep and operation of the equipment.

b. *Preventive Maintenance Checks and Services.* The preventive maintenance checks and services chart (par. 24.1) outlines functions to be performed at specific intervals. These checks and services are to maintain Army electronic equipment in a combat serviceable condition; that is, in good general (physical) condition and in good operating condition. To assist operators in maintaining combat serviceability, the chart indicates what to check, how to check, and what the normal conditions are; the References column lists the illustrations, paragraphs, or manuals that contain supplementary information. If the defect cannot be remedied by the operator, higher echelon maintenance or repair is required. Records and reports of these checks and services must be made in accordance with the requirements set forth in TM 38-750.

23. Preventive Maintenance Checks and Services Periods

Preventive maintenance checks and services of the equipment are required daily. Paragraph 24 specifies the checks and services that must be accomplished daily and under the conditions listed below.

- a. When the equipment is initially installed.
- b. When the equipment is reinstalled after removal for any reason.
- c. At least once each week if the equipment is maintained in standby condition.

24. Daily Preventive Maintenance Checks and Services Chart

Sequence No.	Item	Procedure	Reference
1	Connections	Check to be sure that all cable connections are secure and properly tightened.	Fig. 17 through 22 and 24
2	Cables	Check to be sure that all cables show no evidence of damage or deformity. Inspect the cable for cuts, kinks, or damaged insulation.	Fig. 24.
3	TN-174/GRA-4	Warning: Do not make any replacements or adjustment on the equipment with power on. Adjust the tuning control and observe that the neon bulb glows with varying intensity. Replace a defective neon bulb.	Fig. 23.

Add paragraph 24.1 after paragraph 24:

24.1. Cleaning

Inspect the exterior of the equipment. The exterior surfaces should be clean, and free of dust, dirt, grease, and fungus.

- a. Remove dust and loose dirt with a clean soft cloth.

Warning: Cleaning compound is flammable and its fumes are toxic. Provide adequate ventilation. Do not use near a flame.

- b. Remove grease, fungus, and ground-in dirt from the mast assembly of the AN/FRA4 and AN/FRA-12; use a cloth dampened (not wet) with cleaning compound (Federal stock No. 7930-395-9542).

Page 41. Delete figure 27.

Page 42. section II. Heading. Change the section heading to read:

Section II. ORGANIZATIONAL MAINTENANCE

AGO 6513B

Delete paragraphs 25 through 28 and substitute:

25. Scope of Organizational Maintenance

a. This section contains instructions covering second echelon maintenance of the equipment. It includes instructions for performing preventive and periodic maintenance services and repair functions to be accomplished by the organizational repairman.

b. Second echelon maintenance of the equipment includes:

- (1) Preventive maintenance (par. 28 and 28.1).
- (2) Touchup painting instructions (par. 28.2).
- (3) Troubleshooting (par. 29).
- (4) Replacement of parts (par. 30).

26. Tools, Materials, and Test Equipment Required

The tools and test equipment required for operational maintenance are listed in the maintenance allocation chart (app. I). The materials required are as follows:

- a. Cleaning Compound (Federal stock No. 7930-39-9542).
- b. Cleaning cloth.

27. Organizational Preventive Maintenance

a. Preventive maintenance is the systematic care, inspection, and servicing of equipment to maintain it in serviceable condition, prevent breakdowns, and assure maximum operational capability. Preventive maintenance is the responsibility of all echelons concerned with the equipment and includes the inspection, testing, and repair or replacement of parts, subassemblies, or units that inspection and tests indicate would probably fail before the next scheduled periodic service. Preventive maintenance checks and services of the equipment at the second echelon level are made at monthly and quarterly intervals unless otherwise directed by the commanding officer.

b. Maintenance forms and records to be used and maintained on this equipment are specified in TM 38-750.

28. Monthly Maintenance

Perform the maintenance functions indicated in the monthly preventive maintenance checks and services chart (par. 28.1). A month is defined as approximately 30 calendar days or 8-hour-perday operation. If the equipment is operated 16 hours a day, the monthly preventive maintenance checks and services should be performed at 15-day intervals. Adjustment of the maintenance interval must be made to compensate for any unusual operating conditions. Equipment maintained in a standby (ready for immediate operation) condition must have monthly preventive maintenance checks and services performed on it. Equipment in limited storage (requires service before operation) does not require monthly preventive maintenance.

AGO 6513B

Add paragraphs 28.1 and 28.2 after paragraph 28:

28.1. Monthly Preventive Maintenance Checks and Services Chart

Sequence No.	Item	Procedure	Reference
1	Publications	Check to see that the technical manual is complete and in usable condition. Check DA Pam 310-4 to determine if new, applicable changes have been published.	DA Pam 310-4.
2	Modification work orders.	Check to see that all URGENT MWO's have been applied to the equipment and that all NORMAL MWO's have been scheduled.	DA Pam 310-4.
8	Ground rod	Check to see that the ground rods are firmly embedded in the soil and that the grounding wire is firmly attached to them.	
4	Mast	Check to see that the mast is level. If the mast is badly distorted and cannot be leveled because it has settled unevenly, dismantle the mast and reassemble it on a firmer foundation.	
5	Guys	Check for badly rusted or frayed guys. See that the guys are securely attached to the mast. Check and adjust the tension on the guys.	

28.2. Touchup Painting Instructions

Clean rust and corrosion from metal surfaces by lightly sanding them with fine sandpaper. Brush two thin coats of paint on the bare metal to protect it from further corrosion. Refer to the applicable cleaning and refinishing practices specified in TM 9-213.

Page 43. Delete figure 28.

AGO 6513B

Page 58, appendix I (page 1 of C 1). Change "appendix I" to: appendix II.
 Add appendix I before II:

**APPENDIX I
 REFERENCES**

The following is a list of references applicable and available to the operator and organizational repairman of Antenna Groups AN/GRA-4 and AN/GRA-12:

- | | |
|----------------------|--|
| DA Pam 310-4 | Index of Technical Manuals, Technical Bulletins, Supply Bulletins, Lubrication Orders, and Modification Work Orders. |
| SIG 7&8 AN/GRA-12 | Antenna Group AN/GRA-12. |
| SIG 7&8 RL-122/GRA-4 | Reel RL122/GRA4. |
| TM 9-213 | Painting Instructions for Field Use. |
| TM 11-5895-229-12P | Operator and Organizational Maintenance Repair Parts and Special Tools List and Maintenance Allocation Chart: AB-86/GRA-4. |
| TM 11-5985-231-20P | Organizational Maintenance Repair Parts and Special Tools List: Antenna Group AN/GRA-4. |
| TM 38-750 | The Army Equipment Record System and Procedures. |

Appendix II (page 6 of C 1). Change "appendix II" to appendix III.
 Section I. Delete paragraph 2, "references".
 Section II (page 7 of C 1). Make the following changes:
 Add the following item in the columns indicated below:

2	4	5	6	7
5985-257-2927	ITEMS COMPRISING AN OPERABLE EQUIPMENT ANTENNA GROUP AN/GRA-4 MAST AB-86/GRA-4: sectionalized 2 construction; J and H Smith part No. 100B.	ea	NX	2

"ANTENNA AS-244/GRA-4". Make the following changes:
 Column 2, "5985-497-8765". Column 7, change "2" to: 3
 Column 2, "5985-228-8064". Column 7, change "1" to: 2
 Column 2, "5985-257-2927". Delete item in its entirety.

AGO 6513B

By Order of the Secretary of the Army:

EARLE C. WHEELER,
General, United States Army.
Chief of Staff.

Official:

J. C. LAMBERT,
Major General, United States Army.
The Adjutant General.

Distribution:

To be distributed in accordance with DA Form 12-32, Sec II (Unclass) requirements for Nike Hercules and Improved Nike Hercules and Target Missiles and Pershing and Nike Ajax and Hawk, TM, Radio.

AGO 3613B

CHANGE }
No. 3 }

HEADQUARTERS
DEPARTMENT OF THE ARMY
WASHINGTON, D.C., 31 October 1973

**ANTENNA GROUPS AN/GRA-4
AND AN/GRA-12**

TM 11-2651/TO31R2-2GRA-101, 1 November 1956, is changed as follows:

Page 3, paragraph 1.1. Delete paragraph 1.1 and substitute new paragraph 1.1.

1.1. Indexes of Publications

a. *DA Pam 310-4.* Refer to the latest issue of DA Pam 310-4 to determine whether there are new editions, changes, or additional publications pertaining to the equipment.

b. *DA Pam 310-7.* Refer to DA Pam 310-7 to determine whether there are modification work orders (MWO's) pertaining to the equipment.

Paragraph 2. Delete paragraph 2 and substitute new paragraph 2.

2. Forms and Records

a. *Reports of Maintenance and Unsatisfactory Equipment.* Maintenance forms, records, and reports which are to be used by maintenance personnel at all maintenance levels are listed in and prescribed by TM 38-750.

b. *Report of Packaging and Handling Deficiencies.* Fill out and forward DD Form 6 (Report of Packaging and Handling Deficiencies) as prescribed in AR 700-58 (Army)/NAVSUP PUB 378 (Navy)/AFR 71-4 (Air Force)and MCO P4030.29 (Marine Corps).

c. *Discrepancy in Shipment Report (DISREP) (SF 361).* Fill out and forward Discrepancy in Shipment Report (DISREP) (SF 361) as prescribed in AR 55-38 (Army)/NAVSUP PUB 459 (Navy)/AFM 75-34 (Air Force)and MCO P4610.19 (Marine Corps).

Add paragraph 2.1 after paragraph 2.

TAGO 3169B

2.1. Reporting of Equipment Publication Improvements

The reporting of errors, omissions, and recommendations for improving this publication by the individual user is encouraged. Reports should be submitted on DA Form 2028 (Recommended Changes to Publications) and forwarded direct to Commander, US Army Electronics Command, ATTN: AMSELMA-C, Fort Monmouth, NJ 07703.

Page 5. After paragraph 4 add paragraph 4.1.

4.1. Items Comprising an Operable Antenna Group AN/GRA-4 (FSN 5820-244-5147).

FSN	QTY	Nomenclature, part No., and mfr code
-----	-----	--------------------------------------

NOTE

The part number is followed by the applicable 5-digit Federal supply code for manufacturers (FSCM) identified in SB 708-42 and used to identify manufacturer, distributor, or Government agency, etc.

5820-264-7506	1	Antenna AS-244/GRA-4: 1.5 to 18.0 mHz freq range, wire construction, for receiver and transmitter signals.
5996-247-9759	6	Cord CG-357/U: (50 ft 6 in.) user RG-59A/U cable; SC-D-34932, 80063
5970-405-8223	1	Insulator IL-4/GRA-4: with RF receptable UG-58/U
5985-497-8765	3	Reel RL-122/GRA-4, SC-D-34897, 80063
5210-265-7451	1	Tape, Measuring: 100 ft lg extended, 400-A1, 86794
5985-355-8024	1	Tuner, Antenna: antenna tuner TN-174/GRA-4, SC-D-34917, 80063
5985-257-2927	2	Mast AB-86/GRA-4: sectionalized construction, 100B, 82241

Delete appendix III and substitute new appendix III.

APPENDIX III

BASIC ISSUE ITEMS LIST AND ITEMS TROOP INSTALLED OR AUTHORIZED LIST

Section I. INTRODUCTION

1. Scope.

This appendix lists basic issue items and items troop installed or authorized required by the crew/operator for installation, operation, and maintenance of Antenna Group AN/GRA-4.

2. General.

This Basic Issue Items and Items Troop Installed or Authorized List is divided into the following sections:

a. Basic Issue Items List-Section II. A list, in alphabetical sequence, of items which are furnished with, and which must be turned in with the end item.

b. Items Troop Installed or Authorized List-Section III. A list, in alphabetical sequence, of items which, at the discretion of the unit commander, may accompany the end item, but are not subject to be turned in with the end item.

3. Explanation of Columns.

The following provides an explanation of columns found in the tabular listings:

a. Illustration. Not applicable.

b. Federal Stock Number. Indicates the Federal stock number assigned to the item and will be used for requisitioning purposes.

c. Part Number. Indicates the primary number used by the manufacturer (individual, company, firm, corporation, or Government activity), which controls the design and characteristics of the item by means of its engineering drawings, specifications standards, and inspection requirements, to identify an item or range of items.

d. Federal Supply Code for Manufacturer (FSCM). The FSCM is a 5-digit numeric code used to identify the manufacturer, distributor, or Government agency, etc., and is identified in SB 708-42.

e. *Description.* Indicates the Federal item name and a minimum description required to identify the item.

f. *Unit of Measure (U/M).* Indicates the standard of basic quantity of the listed item as used in performing the actual maintenance function. This measure is expressed by a two character alphabetical abbreviation, (e.g., ea, in., pr, etc.). When the unit of measure differs from the unit of issue, the lowest unit of issue that will satisfy the required units of measure will be requisitioned.

g. *Quantity Furnished with Equipment (Basic Issue Items Only).* Indicates the quantity of the basic issue item furnished with the equipment.

h. *Quantity Authorized (Items Troop Installed or Authorized Only).* Indicates the quantity of the item authorized to be used with the equipment.

Section II. BASIC ISSUE ITEMS LIST

(1) Illustration		(2) Federal Stock Number	(3) Part Number	(4) FSCM	(5) Description Usable on Code	(6) Unit of Meas	(7) Qty Furn With equip
(A) Fig. No.	(B) Item No.						
		5830-497-9628	71-3308	80063	BAG, BG-102, BG-102A	EA	1
		5985-228-8064	SC-C-28054	80063	SLING, HOISTING: HALYARD MX-516/GR-A	EA	2

Section III. ITEMS TROOP INSTALLED OR AUTHORIZED LIST

(1) Federal Stock Number	(2) Part Number	(3) FSCM	(4) Description Usable on Code	(5) Unit of Meas	(6) Qty Auth
5120-288-7783	860	83330	TOOL ALIGNMENT: APPROX 5/32 in. X 1/32 in. THK, SEDR NIB IN ONE END, 6 in. LG X 7/32 IN. DIA	EA	1

By Order of the Secretary of the Army:

CREIGHTON W. ABRAMS
General, United States Army
Chief of Staff

Official:

VERNE L. BOWERS
Major General, United States Army
The Adjutant General

Distribution:

To be distributed in accordance with DA Form 12-51 operator maintenance requirements for AN/GRA-4 and AN/GRA-12.

ANTENNA GROUPS AN/GRA-4 AND AN/GRA-12

		Paragraph	Page
CHAPTER 1.	INTRODUCTION		
SECTION I.	General.		
	Scope	1	3
	Forms and records	2	3
II.	Description and data.		
	Purpose and use	3	5
	Technical characteristics	4	6
	Components	5	5
	Common name and nomenclature	6	10
	Description of Antenna Mast Assembly		
	AB-86/GRA-4	7	11
	Description of Antenna AS-244/GRA-4	8	12
	Description of Accessory Kit MX-1137/GRA-12	9	13
	Running spares	10	13
	Differences between Antenna Groups		
	AN/GRA-4 and AN/GRA-12	11	14
CHAPTER 2.	INSTALLATION		
	Selecting type of antenna	12	15
	Siting	13	17
	Unpacking	14	20
	Installation of mast assembly	15	23
	Raising mast	16	26
	Determining length of antenna	17	27
	Installing antenna, using Antenna Group		
	AN/GRA-4	18	30
	Installing antenna, using Antenna Group		
	AN/GRA-12	19	38
	Tuner TN-174/GRA-4, control	20	39
3.	ORGANIZATIONAL MAINTENANCE		
SECTION I.	First echelon (operator) maintenance.		
	Scope of operator's maintenance	21	40
	Tools, materials, and test equipment required	22	40
	Operator's preventive maintenance	23	40
	Visual inspection	24	41
II.	Second echelon (unit repairman) maintenance.		
	Scope of unit repairman's maintenance	25	42
	Tools, materials, and test equipment required	26	42
	Unit repairman's preventive maintenance	27	42
	Unit repairman's visual inspection	28	42
	Troubleshooting	29	44
	Replacement of parts	30	45
CHAPTER 4.	THEORY		
	Circuit theory	31	48
	Antenna circuits	32	50
	Tuner TN-174/GRA-4	33	54
5.	SHIPMENT, LIMITED STORAGE, AND DEMOLITION		
SECTION I.	Shipment and limited storage.		
	Disassembly of equipment	34	56
	Repacking for shipment or limited storage	35	57
II.	Demolition of material.		
	Authority for demolition	36	58
	Methods of destruction	37	58

*This manual supersedes TM 11-2651, 21 July 1952

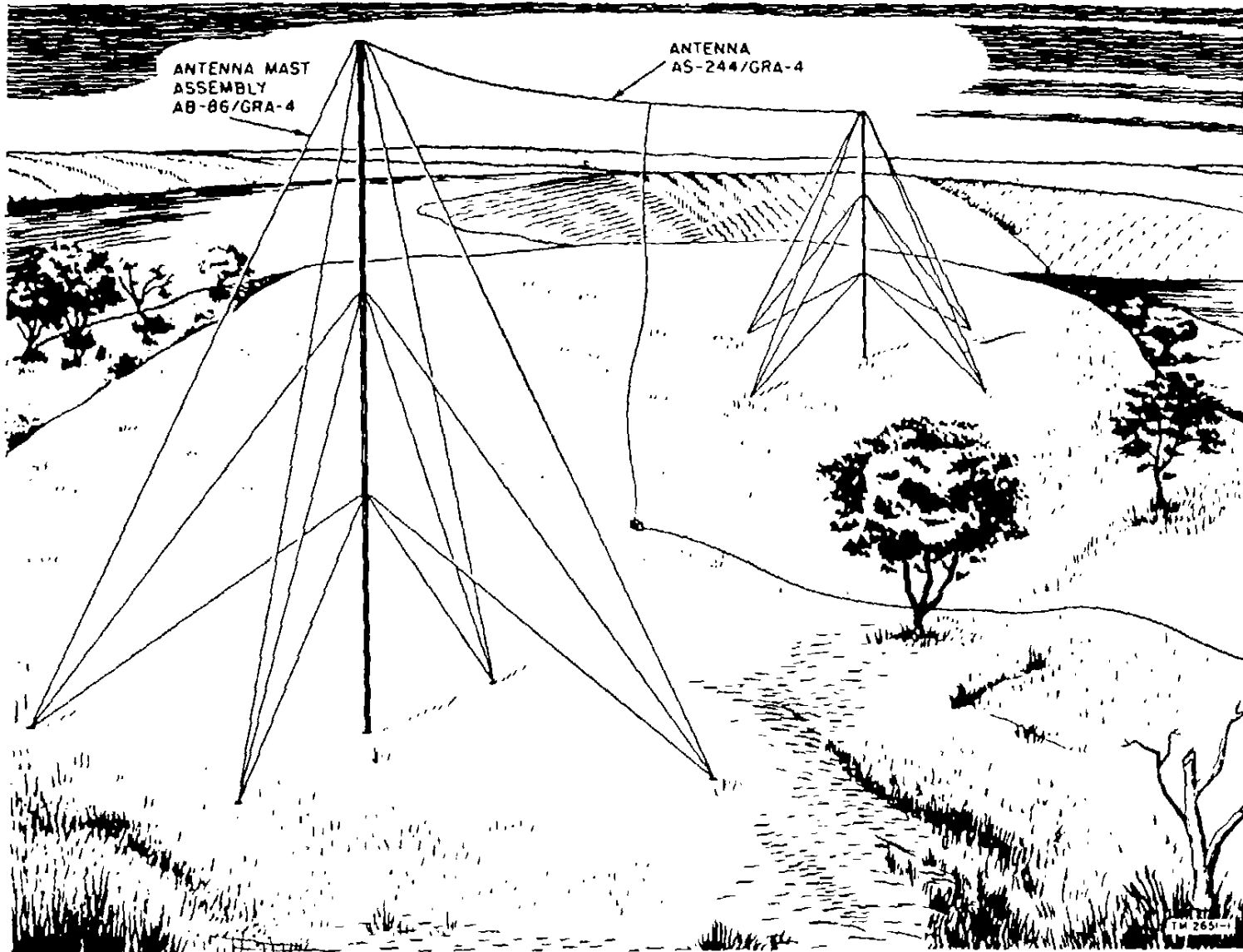

Figure 1. Antenna Group AN/GRA-4.

CHAPTER 1
INTRODUCTION

Section I. GENERAL

1. Scope

a. This manual contains information for the installation, operation, maintenance, and repair of Antenna Group AN/GRA-4 (fig.1) and Antenna Group AN/GRA-12 (fig. 2).

b. Forward comments on this publication directly to Commanding Officer, The Signal Corps Publications Agency, Fort Monmouth, N. J.

2. Forms and Records

a. *Unsatisfactory Equipment Reports.* Fill out and forward DA Form 468 (Unsatisfactory Equipment Report) to Commanding Officer, Signal Equipment Support Agency, Fort Monmouth, N. J., as prescribed in AR 700-38.

b. *Damaged or Improper Shipment Report.* Fill out and forward DD Form 6 (Report of Damaged or Improper Shipment) as prescribed in AR 700-58 (Army); Navy Shipping Guide, Article 1850-4 (Navy); and AFR 71-4 (Air Force).

c. *Preventive Maintenance Forms.*

- (1) DA Form 11-238 (Operator First Echelon Maintenance Checklist for Signal Corps Equipment (Radio Communication, Direction Finding, Carrier, Radar)) will be prepared in accordance with instructions on the back of the form (fig. 27).
- (2) DA Form 11-239 (Second and Third Echelon Maintenance Checklist for Signal Corps Equipment (Radio Communication, Direction Finding, Carrier, Radar)) will be prepared in accordance with instructions on the back of the form (fig. 28).

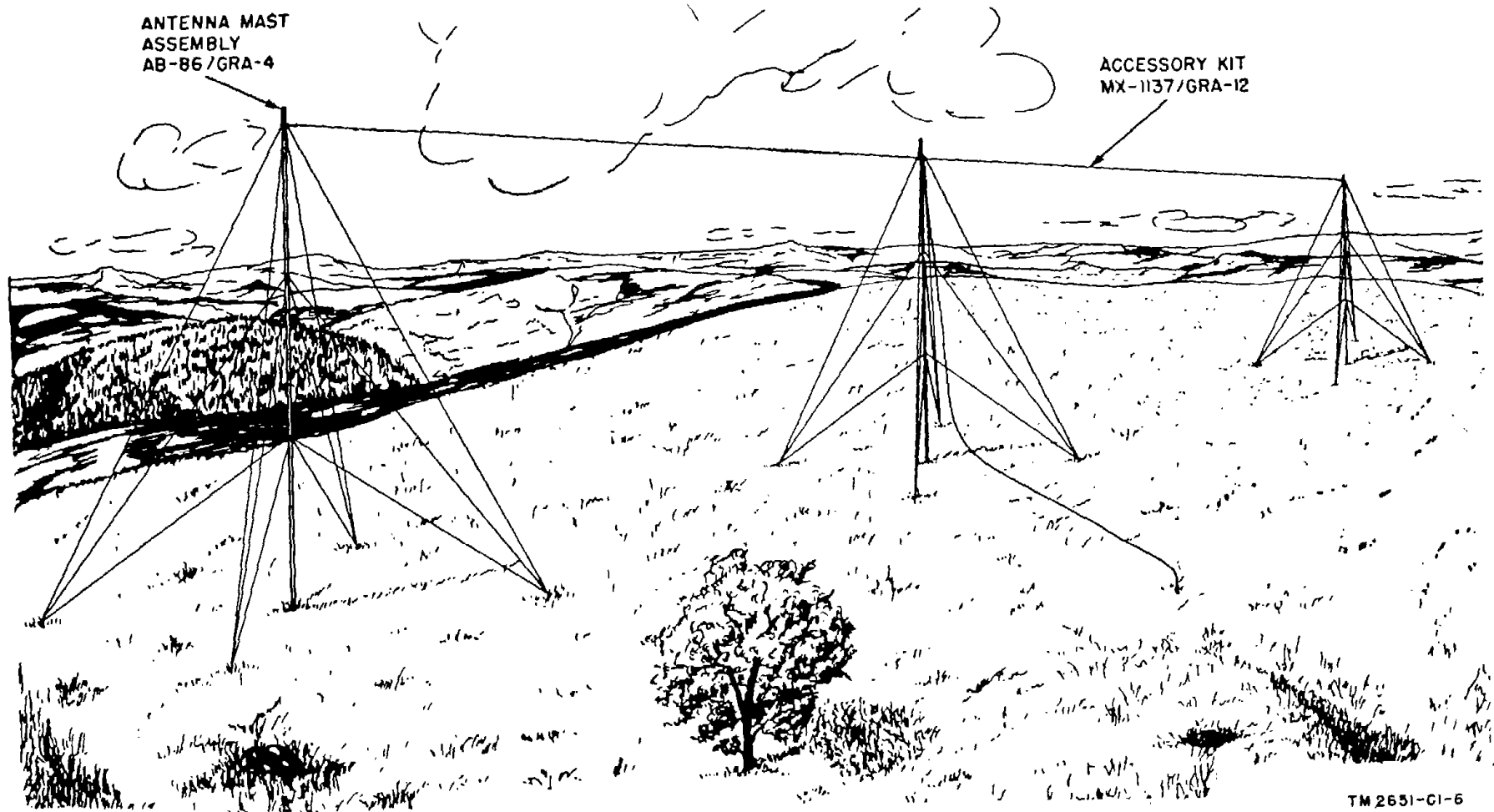

Figure 2. Antenna Group AN/GRA-12.

TM 2651-C1-6

Section II. DESCRIPTION AND DATA

3. Purpose and Use

Antenna Groups AN/GRA-4 and AN/GRA-12 are portable, half-wave antenna assemblies designed for the transmission and reception of radio signals between 1.5 and 18 megacycles (mc).

a. The AN/GRA-4 antenna is used in conjunction with any radio set that has a transmitter output of less than 100 watts and a characteristic impedance of 72 or 500 ohms. Several different types of antennas can be set up by using various combinations of the components supplied.

b. The AN/GRA-12 antenna is used with any radio set having a transmitter output of 500 watts or less and has a characteristic impedance of 52 ohms.

4. Technical Characteristics

a. Antenna Group AN/GRA-4.

Power input	Up to 100 watts.
Frequency range.....	1.5 to 18 mc.
Weight	169 pounds.
Antenna type.....	Half-wave.
Impedance.....	72 or 500 ohms.

b. Antenna Group AN/GRA-12

Power input	Up to 500 watts.
Frequency range	1.5 to 18 mc.
Weight	229 pounds
Antenna type.....	Center-fed Hertz (half-wave).
Impedance.....	52 ohms.

5. Components

a. Antenna Group AN/GRA-4 consists of one Antenna AS244/GRA-4 and two Antenna Mast Assembly AB-86/GRA-4 (fig. 1). The antenna includes wire, insulators, halyards, tuning unit, and a carrying case. The mast assembly consists of 16 metal mast sections, a whip adapter, counterpoise, halyard, insulator, associated guys and stakes, and a carrying case. The units may be used to construct several different antenna combinations.

b. Antenna Group AN/GRA-12 consists of one Accessory Kit MX-1137/GRA-12 and three Antenna Mast Assembly AB86/GRA-4 (fig. 2). The accessory kit includes wire, a cable assembly, measuring tape, and carrying case. Each mast assembly contains 16 metal mast sections, a whip adapter, a counterpoise, a halyard, an insulator, associated guys and stakes, and a carrying case. The antenna group is used to construct a center-fed Hertz antenna.

Component	Required No.	Height (in.)	Depth (in.)	Length (in.)	Unit weight	
					(lb)	(Oz)
Antenna Mast Assembly AB-86/GRA-4	5	10 1/2	8½	36	69	7
Mast Section AB-85/GRA-4	16	3 (ft)	1.625 OD		2	8
Frame MX-1116/GRA-4	1	8%	10 1/2	35		
Hammer HM-1	1				2	9
Counterpoise CP-12	1			25 (ft) each radial	1	11
Insulator MX-384/GRA-4	1	16 9/16	2 13/16 dia		2	15
Mast Base AB-154/U	1	17 1/2	13/8 dia			12
Wire W-128	1			10 (ft)		9
Guy Stake GP-111/G	4	18	1 1/4	1 1/4	1	
Guy MX-383/GRA-4	4	3/16 dia		50 (ft)		12
Guy MX-381/GRA-4	4	3/16 dia		40 (ft)		11
Guy MX-382/GRA-4	4	3/16 dia		31 (ft)		10
Guy Plate MX-378/U	3	.089 thk	3 dia			2
Antenna Adapter MX-857/GRA-4	1	9	1 5/8 dia			13
Halyard MX-516/GRA-4	1		3/16 dia	140 (ft)	2	
Antenna AS-244/GRA-4	1	14	9	14	29	8
Bag BG-102-A	1	14	5	14	2	13
Reel RI122/GRA-4	3	2	4.25	12.5	2	3
Cord CG-357/U	6			50 (ft)	1	15
Insulator IL-4/GRA-4	1	3.5	3	1		8
Tape, stainless steel (100 ft)	1	.5	4.5	4.5	1	3
Halyard MX-516/GRA-4	2		3/16 dia	140 (ft)	2	
Lead-in Wire W-128	2			10 (ft)		9
o Tuner TN-174/GRA-4	1	4	3	6 ½	1	11
Accessory Kit MX-1137/GRA-12	1				20	2
Bag CW-206/GR	1	11	3	11 1/2	2	13

Reel Assembly RL122/GRA-4	3	2	4.25	12.5	2	3
Tape, stainless steel (100 ft)	1	5	4.5	4.5	1	3
RF Cable Assembly CG-692/U	1			75 (ft)	9	1
Hook assembly	2	1.25	1.25	7.0		4

Notes:

1. Refer also to paragraph 10.
2. This list is for general information only. See appropriate supply publications for information pertaining to requisition of spare parts.
3. Antenna Group AN/GRA-12 requires three Masts AB-86/GRA-4.

TAGO 2189B

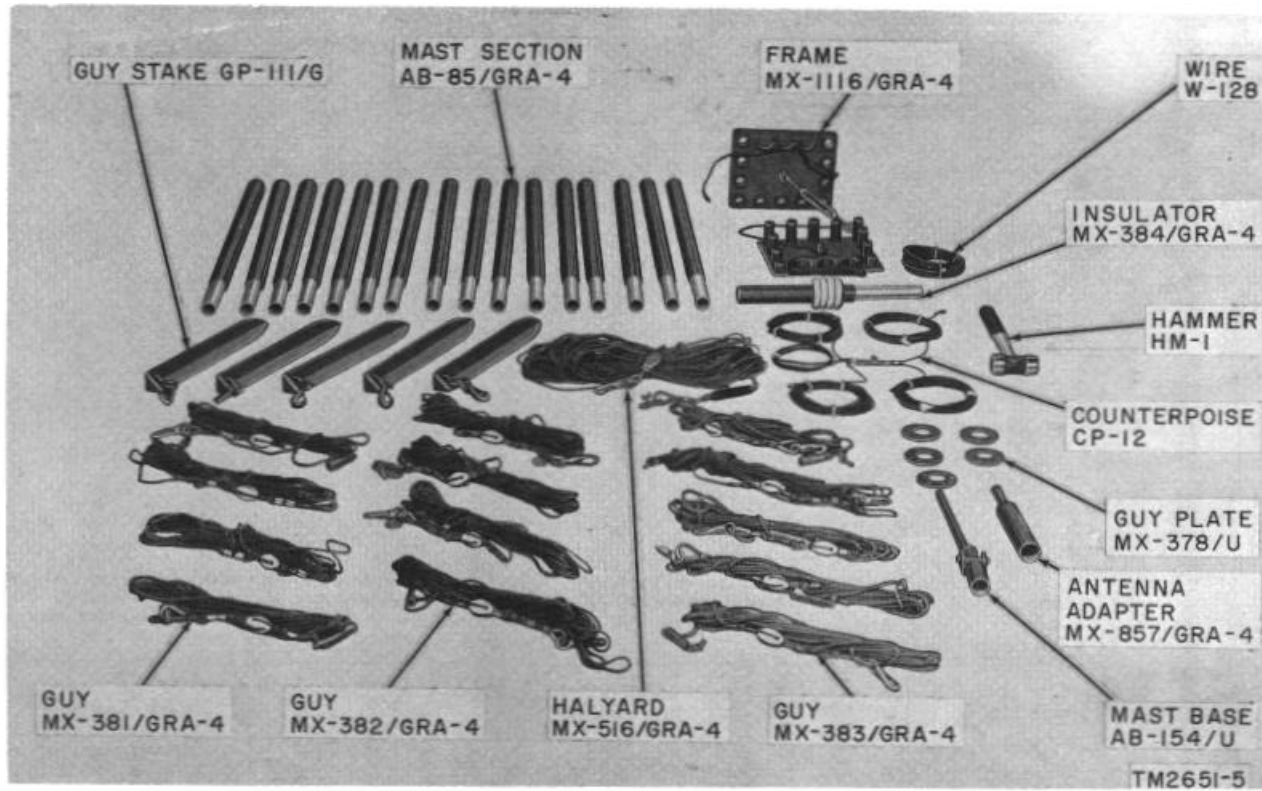

Figure 3. Antenna Mast Assembly AB-86/GRA-4, components.

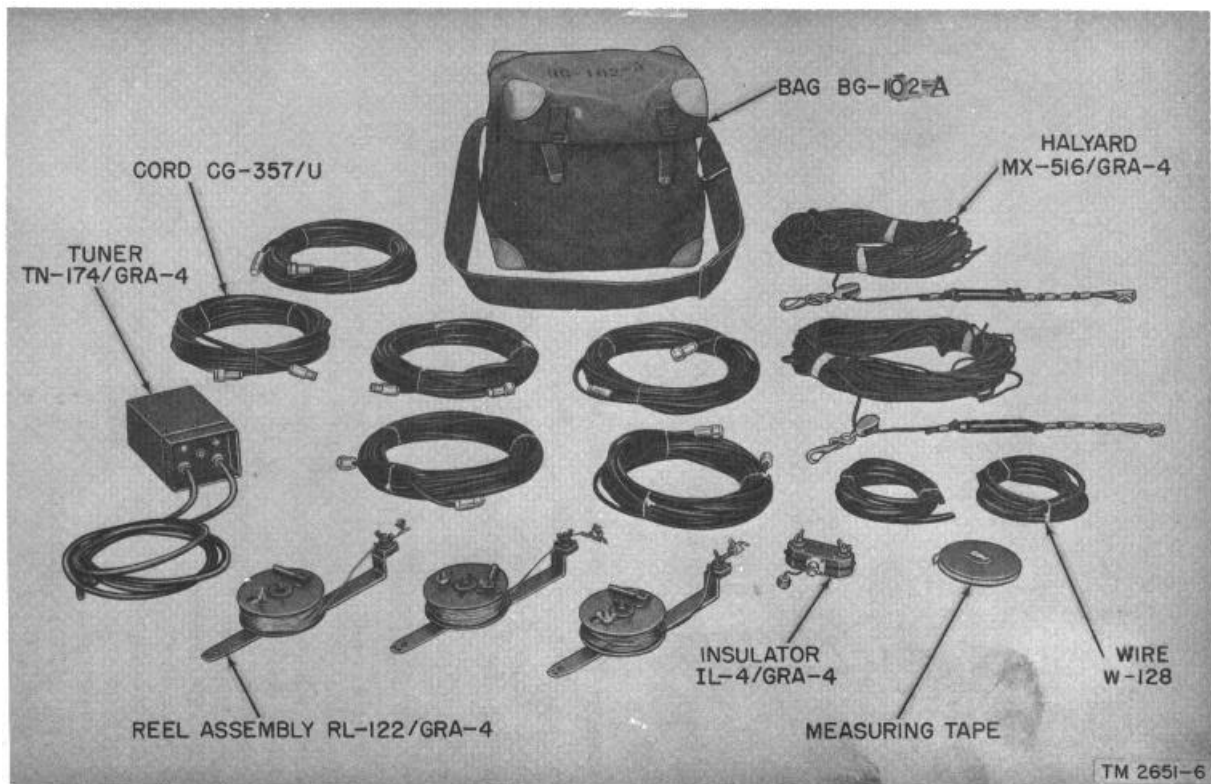

Figure 4. Antenna AS-244/GRA-4, components.



Figure 5. Accessory Kit MX-1137/GRA-12, components.

6. Common Name and Nomenclature

A list of the nomenclature assignments for the components of Antenna Groups AN/GRA-4 and AN/GRA-12 is given below. A common name is indicated after each item.

Nomenclature	Common name
Antenna Mast Assembly AB-86/GRA-4	Antenna mast assembly or mast assembly
Mast Section AB-85/GRA-4	Mast section
Frame MX-1116/GRA-4	Frame
Counterpoise CP-12	Counterpoise
Mast Base AB-154/U	Mast base
Halyard MX-516/GRA-4	Halyard
Insulator MX-384/GRA-4	Insulator
Antenna AS-244/GRA-4	Antenna or antenna assembly
Reel RL-122/GRA-4	Reel assembly
Tuner TN-174/GRA-4	Tuner
Accessory Kit MX-1137/GRA-12	Accessory kit
Guy Stake GP-111/G	Guy stake
Antenna Adapter MX-857/GRA-4	Antenna adapter
Guy Plate MX-378/U	Guy plate
Guy MX-381/GRA-4	40 ft guy
Guy MX-382/GRA-4	31 ft guy
Guy MX-383/GRA-4	50 ft guy

7. Description of Antenna Mast Assembly AB-86/GRA-4

(fig. 3)

a. Mast Section AB-85/GRA-4 is a 3-foot aluminum tube. One end of the tube is smaller in diameter so that it can be fitted into the larger end of the next section, thus reducing the effective length of each section to 2 1/2 feet. A set of contact fingers is mounted in the larger end of each section to assure positive contact between sections when the mast is used as a vertical antenna.

b. Frame MX-1116/GRA-4 consists of two aluminum end plates. Each of these plates has 11 tube fittings which fit into the mast sections. When assembled with the mast sections for transportation, the end plates are held in place by a steel cable. A turnbuckle keeps the cable taut. Eleven of the mast sections form a trough in which two mast sections and all the other components of the mast assembly can be packed. The other three mast sections fit into a rack and are strapped into place, thus serving as the top of the case. A handle is provided at each end for carrying.

c. Counterpoise CP-12 (fig. 16) consists of a center plate, four 25-foot radials, and a ground wire. It is used for a ground system when the mast is used as a 40-foot or 55-foot vertical radiator.

d. Insulator MX-384/GRA-4 is a molded fiberglass insulator. It fits at the junction of any two mast sections but normally is used at the mast base.

e. Antenna Adapter MX-857/GRA-4 is a 9-inch aluminum tube fitted on one end with a set of contact fingers to fit over the top mast section. The other end forms a receptacle for additional mast sections to permit extending the over-all mast to 55 feet for special uses. Three Mast Sections MS-116, one Mast Section MS-117, and one Mast Section MS-118 are required with the adapter for this service. These mast sections are not furnished with Antenna Group AN/GRA-4 and must be requisitioned.

f. Mast Base AB-154/U (swivel stake) consists of an aluminum stake with a pivoting clevis at one end. The upper portion of the clevis fits into the lower end of a mast section or the base insulator.

g. The lead-in wire is a 10-foot section of Wire W-128. It serves as the transmission line between the antenna and the tuning unit.

h. Guy Stake GP-111/G is constructed of metal and is 18 inches long. A fastener which is permanently attached to the top of the stake fastens to the guys.

i. Guys MX-383/GRA-4, MX-381/GRA-4, and MX382/GRA-4 are all similar, the only differences being in the color code (red, white, and blue, respectively) and the length (50 feet, 40 feet, and 31 feet, respectively). They are made of 3/16-inch, three-strand twist rope. One end is provided with a length-adjustment Fastener FT-9; a snap hook and strain insulator are attached to the other end.

j. Guy Plate MX-378/U consists of a round steel plate 3 inches in diameter. The center hole fits over the male end of a mast section, and five outer holes serve for attaching the four guy ropes and a halyard.

k. Halyard MX-516/GRA-4 consists of a 140-foot length of 3/16-inch, three-strand twist rope. One end of the rope is fitted with an insulator and a fastener which attaches to Reel RL122/GRA-4 or directly to Wire W-120. A pulley which floats on the halyard attaches to the top guy plate with a snap hook.

8. Description of Antenna AS244/GRA-4

(fig. 4)

a. Bag BG-102-A is constructed of heavy canvas and is used for storage of small components.

b. Reel Assembly RL-122/GRA- consists of one Reel RL 122/GRA-4 and 150 feet of Wire W-120. Each end of the wire is equipped with a mating termination so that the wires from any number of reels can be combined to make up longer antennas. Two small holes are provided in the reel handle for connection to the halyard.

c. Cord CG-357/U consists of 50 feet of Radio Frequency Cable RG-59A/U which has an impedance of 72 ohms. The cable is terminated with a male and female coaxial fitting in either end. It is used with the center-fed Hertz (doublet) antenna installation (fig. 10).

d. Insulator IL-4/GRA-4 consists of laminated phenolic plates, having two terminals for connection of Wire W-120 (antenna wire) and a female coaxial fitting for connection of Cord CG357/U. The insulator is used at the center of the doublet. antenna installation.

e. The stainless steel measuring tape is 100 feet long. It is used to measure the length of antenna necessary for operation at a given frequency.

f. Halyard MX-516/GRA-4 consists of 140 feet of nylon rope, 3/16 inch in diameter. An insulator and fastener are attached to one end of the rope. The fastener can be connected to the reel or directly to Wire W-120. A pulley floats on the halyard and is attached to the top guy plate by means of a snap hook.

g. The lead-in wire is a 10-foot section of Wire W-128. In use, one end of the wire is connected to Wire W-120 (antenna reel), and the other end is connected to the tuning unit.

h. Antenna Tuner TN-174/GRA-4 consists of a 12- to 244micromicrofarad (µef) variable capacitor. A neon bulb is wired in parallel to indicate resonance during antenna loading, and a slotted shaft adjustment is provided to vary the capacitance. Two wires are permanently connected to the unit; one wire is fitted with a wire termination which attaches to the antenna lead-in wire, and the other wire connects directly to the radio set. A binding post for a ground connection is also provided.

9. Description of Accessory Kit MX-1137/GRA-12

(fig. 5)

a. Bag CW-206/GR is constructed of heavy canvas and serves as a storage case for the other components of the kit.

b. Reel Assembly RT-122/GRA-4 consists of one ReelRem 122/GRA-4 and 150 feet of Wire W-120. Each end of the wire is equipped with a mating termination so that the wires from any number of reels can be combined to make up longer antennas. Two small holes are provided in the reel handle for connection to the halyard.

c. The stainless steel measuring tape is 100 feet long.

d. RF Cable Assembly CG-692/U consists of 75 feet of RF Cable RG-8A/U having an impedance of 52 ohms. The cable is terminated at one end with a male coaxial connector and at the other end with a special weather-tight antenna connector for use with center-fed antennas. This cord is used for the center-fed Hertz antenna built with Antenna Group AN/GRA-12.

e. The hook assembly consists of two snap hooks joined by a steel ring. One hook assembly is used for the center-fed Hertz antenna and also to fasten the halyard on the center mast to the special antenna connector on RF Cable Assembly CG-692/U. Two hook assemblies can also be used to fasten the reel assemblies to the halyards if desired.

10. Running Spares

a. The following spares are supplied with Antenna Mast Assembly AB-86/GRA-4:

- 1 Guy Stake GP-111/G
- 2 Guys MX-383/GRA-4 (red)
- 2 Guy Plates MX--378/U
- 2 hooks

b. No running spares are supplied with Antenna AS244/GRA-4.

- c. One spare hook assembly is supplied with Accessory Kit MX-1137/GRA-12.

11. Differences Between Antenna Groups AN/GRA-4 and AN/GRA-12

Each antenna group consists of an antenna and supporting mast sections. The two groups differ as follows:

a. Mast Section. Antenna Group AN/GRA-4 contains two Antenna Mast Assemblies AB-86/GRA-4, and Antenna Group AN/GRA-12 contains three Antenna Mast Assemblies AB86/GRA-4. Antenna Group AN/GRA-12 is designed primarily to make a center-fed Hertz antenna only, using all three mast assemblies.

b. Antenna Section. Antenna Group AN/GRA-4 contains one Antenna AS-244/GRA-4, and Antenna Group AN/GRA-12 contains one Accessory Kit MX-1137/GRA-12. The differences between Antenna AS-244/GRA-4 and Accessory Kit MX1137/GRA-12 are shown in the following chart:

Item	AS-244/GRA-4 used in AN/GRA-4	MX-1137/GRA-12 used in AN/GRA-12
RF cable (used for center-fed Hertz antenna).	Contains 6 Cords CG-357/U, 50 ft long, 72 ohms impedance.	Contains one RF Cable Assembly CG-692/U, 75 ft long, 52 ohms impedance.
Insulator (used) for center-fed Hertz antenna.	Contains one Insulator IL-4/GRA-4. Assembly CG-692/U	Contains one insulator as part of RF Cable (permanently connected to cable).
Halyards.	Contains two Halyards MX-516/GRA-4 in addition to those included in mast AB-86/GRA-4 (total 4 halyards).	Contains no halyard in addition to those included in mast assemblies (total 3 halyards).
Wire W-128.	Contains two 10-foot lengths in addition to those included in mast assemblies (total of 4 lengths).	Contains no lengths of Wire W-128 in addition to those included in mast assemblies (total of 3 lengths).
Tuning unit.	Contains one Antenna Tuner TN-174/GRA-4.	Tuning unit not included.
Hook assemblies (used for center-fed Hertz antenna).	Hook assemblies not included (not required with Antenna Group AN/GRA-4).	Contains three hook assemblies.

CHAPTER 2 INSTALLATION

12. Selecting Type of Antenna

a. *General.* When selecting the antenna, the basic concepts of good military radio communications as well as the operating characteristics of each type of antenna should be taken into account. Table I summarizes the characteristics of each antenna.

b. *Vertical Antennas.* A vertical antenna can be used for both transmitting and receiving at distances up to 30 miles over open terrain and at frequencies of 1.7 to 2.0 mc. Radiation depends on ground waves. Antenna Mast Assembly AB-86/GRA-4 can be used to make up a 40-foot vertical radiator (fig. 16) or, with a whip adapter, a 55-foot vertical radiator, as required. The vertical antenna must be located within 10 feet of the radio set.

c. *Horizontal Antennas.* In areas, such as jungles, where vegetation is very dense, vertical antennas are not useful because all the ground wave is absorbed by the surrounding growth, and only very weak sky waves are transmitted. This necessitates the use of a horizontal antenna and sky wave communication. The specific type of horizontal antenna to be used is determined by the conditions and terrain at the radio station and the frequency of the associated radio set. The various types of horizontal antenna which can be made up from Antenna Group AN/GRA-4 and the characteristics of each are discussed below.

(1) *Slanting wire antenna.*

- (a) If the station is located in a clearing, a slanting wire can be used as an antenna by attaching one end to the 40-foot mast or to a tall tree (fig. 6). If the operating frequency is relatively low, a comparatively long antenna must be used. (Frequencies lower than 3.1 mc require the use of two reel assemblies.) Since a slanting wire antenna longer than 100 feet introduces excessive sag, height must be sacrificed. Therefore, it is advisable to use this antenna with operating frequencies not less than 4.5 mc.
- (b) The slanting wire antenna is highly directional, and cannot be used very successfully for communication with more than one station.

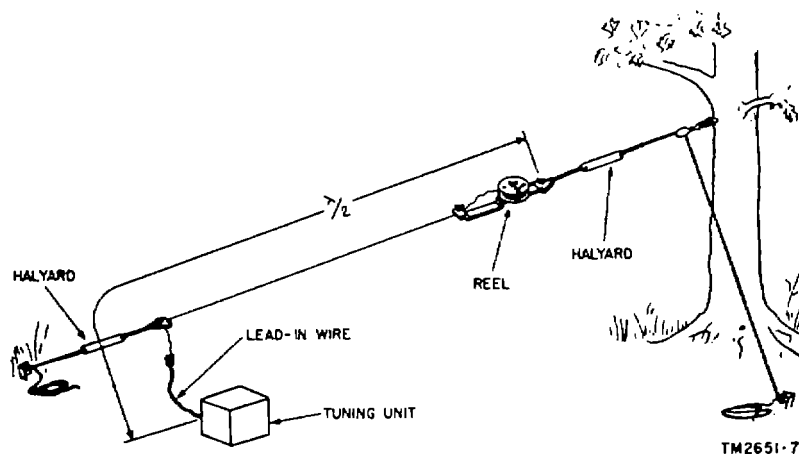

Figure 6. Slanting wire antenna.

(2) *L-type antenna.*

- (a) If the radio station is located in a clearing, the L-type antenna can be used with two mast assemblies or with one mast assembly and a structural member as support (fig. 7).
- (b) The L-type antenna is most efficient when installed so that the horizontal portion is one-half wave length and the down lead is one-quarter wave length. Since the mast assembly is 40 feet high and the vertical portion should be as straight as possible, the antenna operates most efficiently at a frequency of 5.6 mc. At all other frequencies, a compromise must be made. The antenna should not be used at frequencies higher than 5.8 mc. At frequencies lower than 3.1 mc, two reel assemblies must be used to make up the necessary length.

(3) *Off-center-fed Hertz antenna.*

- (a) If the station is located in a clearing where mast assemblies can be set up on each side, the off-center-fed Hertz antenna (fig. 8) can be used to advantage. The lead-in wire should be vertical, and its length should not exceed the length of the antenna; in no case should it exceed 100 feet. This type of antenna can be used on all frequencies between 1.5 and 11.0 mc.
- (b) This antenna uses a single wire transmission line and depends on the ground for a return circuit. Therefore, good conducting ground is essential.

(4) *Center-fed Hertz antenna.*

- (a) If the station is concealed but a clearing exists within 300 feet, the center-fed Hertz (doublet) antenna (fig. 9) can be used with two mast assemblies as supports. The coaxial cable which serves as a feed should be routed at a 90° angle to the antenna and should be kept to minimum length.
- (b) The center-fed Hertz antenna is always one-half wave length long and is fed at the center. It can be used on frequencies from 1.5 to 18 mc.
- (c) Since received signals are weaker than transmitted signals and may be further attenuated by a long transmission line, it is better to use a separate receiving antenna located near the receiver.

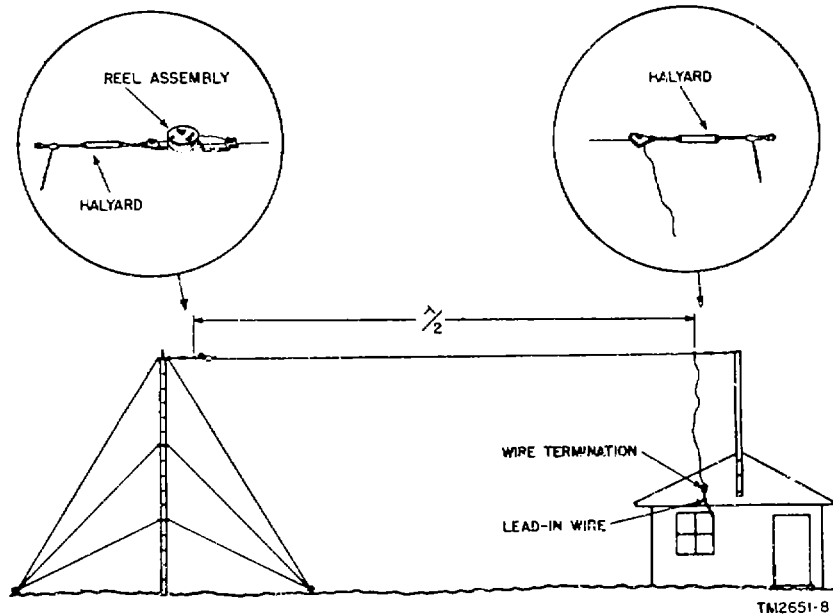
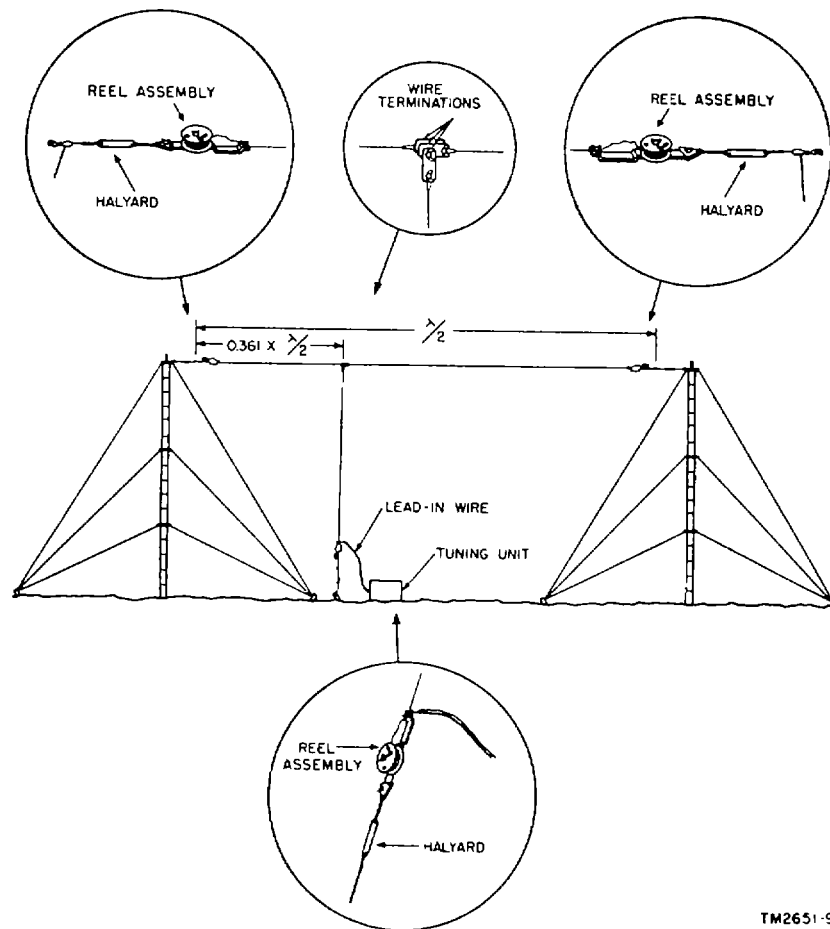

Figure 7. L-type antenna.

13. **Siting**

a. *General.* When choosing a location for setting up the mast assembly and antenna, the conditions listed in table I should first be taken into consideration. Location of the distant station also should be taken into account. When communicating with two or more distant stations, the antenna should be located in a position favorable to the station most difficult to receive.

b. *Vertical Antennas.* The ideal location for erecting a vertical antenna is the center of a plateau having no natural or artificial



TM2651-9

Figure 8. Off-center-fed Hertz antenna.

obstructions nearby. When possible, select a spot of dry ground having good drainage to provide a firm base for the stakes.

c. Horizontal Antennas. If the location of the communication center is not suitable for a vertical antenna, use a horizontal antenna. Locate it in a clearing and determine its direction by the orientation at which it takes fullest advantage of its radiation pattern. Since the radiation pattern of the half-wave antenna is broadside to the wire, the antenna should be erected with the wire broadside to the distant station. When two or more stations are to be considered, orient the antenna so that the broadside of the wire faces the station most difficult to receive. Note that both location and orientation should be determined by the distant stations whenever possible.

Table I. Characteristics of Various Antenna Arrangements

Antenna type	Terrain characteristics	Type of support	Recommended frequency (mc)	Limitations
Vertical	Open	Mast assembly used as radiator.	1.7 to 2.0	Uses ground wave only. Must be within 10 feet of radio set.
Slanting wire	Large clearing near station.	Mast assembly or tree.	Not less than 4.5	Highly directional.
L	Clearing adjacent to station.	2 mast assemblies or 1 mast assembly and structure.	5.6 (ideal) or lower	Lower than 3.1 mc requires use of two reel assemblies. Lead-in as near to 90° vertical as possible.
Off-center-fed Hertz	Clearing adjacent to station.	2 mast assemblies.	1.5 to 11.0	Length of lead-in cannot exceed antenna length nor length of 100 feet. Lead-in on 90° vertical
Center-fed Hertz	Clearing within 300 feet of station.	2 mast assemblies.	1.5 to 18	Uses coaxial cable. May require separate receiving antenna

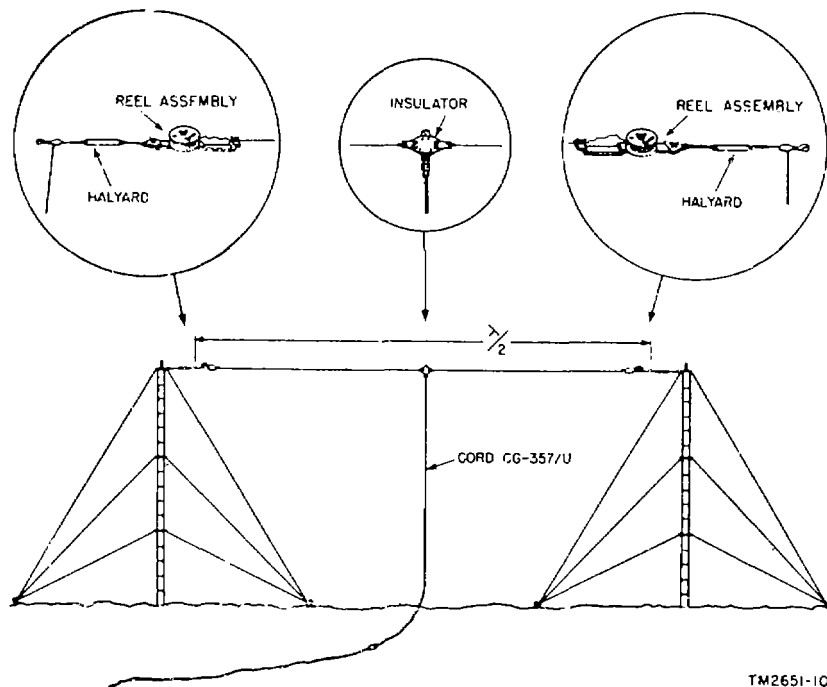

Figure 9. Center-fed Hertz (doublet) antenna, using Antenna Group AN/GRA-4.

14. Unpacking

a. Packaging Data for Antenna Group AN,/GRA-4. When packed for shipment, Antenna AS-244/GRA- is placed in Bag BG-102-A with two copies of TM 11-2651. Each of the two mast assemblies is assembled in its carrying frame. Each of the three components is then placed in a separate corrugated carton. The end plates of the frame are protected by corrugated end caps. A. corrugated filler is placed in the carton with the canvas bag. Each carton is then sealed, and the three cartons are placed in a nailed wooden box which is secured with steel straps. The shipping box with its contents is 15 inches high, 22 inches wide, and 53 inches deep. It weighs 210 pounds and has a volume of 10.1 cubic feet.

b. Packaging Data for Antenna Group AN/GRA-12. When packed for shipment, the components of Antenna Group AN/ GRA-12 are placed in two fiberboard cartons; one carton contains the 48 mast sections, and the other contains all the other components.

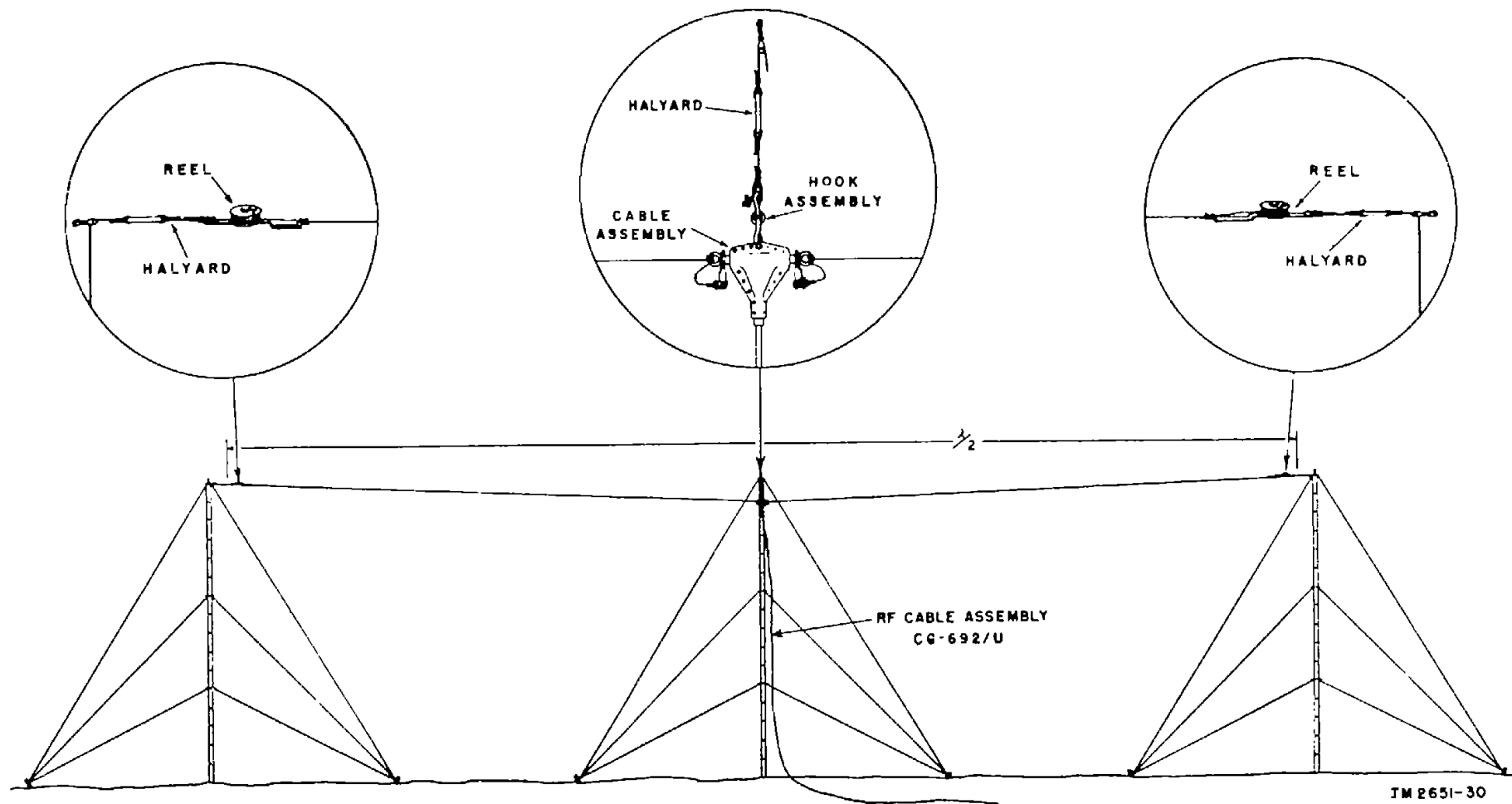

Figure 10. Center-fed Hertz (doublet) antenna, using Antenna Group AN/GRA-12.

- (1) Each mast section is wrapped in flexible corrugated paper and secured with gummed Kraft tape. The 48 mast sections then are placed in a close-fitting fiberboard carton which is then sealed with water-resistant pressure-sensitive tape.
- (2) Each remaining component is packaged individually as follows:
 - (a) Antenna Adapters MX-857/GRA-4, Frames MX1116/GRA-4 Hammers HM-1, Insulators MX384/GRA-4, Halyards MX-516/GRA-4, guy stakes hook assemblies, and Guy plates MX-378/U are wrapped in flexible corrugated paper and secured with gummed Kraft tape.
 - (b) Bag CW-206/GR is folded and tied with cotton tape, and Guys MX-381/GRA-4, MX-382/GRA-4, and MX-383/GRA-4 are wound into coils and tied in three places with cotton tape. The bag and guys are then placed in individual sealed waterproof bags.
 - (c) Wire W-128 (10-foot lengths), Counterpoise CP-12, RF Cable Assembly CG-692/U, and the steel tape (100 feet) are individually wrapped in flexible corrugated paper and secured with gummed Kraft tape. Each item is then placed in a sealed moisture-vaporproof bag.
- (3) All the components listed in (2) above are tightly packaged in one fiberboard carton and all voids are filled with corrugated paper to avoid shifting. The carton is then sealed with water-resistant pressure-sensitive tape.
- (4) The two cartons packed with the equipment are approximately 16 inches high, 28 1/2 inches wide and 38 inches deep. They weigh 250 pounds and have a volume of 11.1 cubic feet.

c. *Removing Contents.* When unpacking equipment in wooden boxes, perform all the steps outlined below. When unpacking equipment in cartons, omit the steps in (1) through (3) below.

- (1) Cut and fold back the metal straps.
- (2) Remove the nails from the top and one side of the box with a nail puller. Remove the top and one side. Do not attempt to pry them off because the equipment may become damaged.
- (3) Open the moistureproof barrier that covers the carton inside the box. Remove the carton.
- (4) Open the carton and the moisture-vaporproof barrier within the carton. Remove the inner cartons. Open the inner cartons and remove the contents.

(5) When unpacking the mast assembly, proceed as follows:

- (a) Unfasten the two straps at the top of the unit and remove the three mast sections which rest in the racks on the end plates.
- (b) Remove all guys, stakes, etc., from inside the frame.
- (c) Loosen and unhook the turnbuckle and cable which hold the end plates together.
- (d) Remove the end plates to free the remaining mast sections.
- (e) Remove the guy plates from the cable of the carrying frame.

(6) To unpack the antenna assembly, open the canvas bag and remove the technical manuals and components.

d. Checking Unpacked Equipment. Inspect the equipment for damage possibly incurred during shipment. If the equipment has been damaged, refer to paragraph 2. Check the equipment against the packing list and against the table of components in paragraph 5.

15. Installation of Mast Assembly

a. General. When the location for the mast assembly (par. 12 and 13) has been chosen, drive the swivel stake on the mast base into the ground at the selected point; use the hammer supplied.

b. Mast Sections and Guy Plates.

- (1) Place the mast sections in a line on the ground (fig. 13) with the female end of each section pointing toward the swivel stake.

Note. If the mast assembly is to be used as an antenna support, the direction in which the antenna will run should first be determined. The line of mast sections should be placed approximately 135° counterclockwise from the direction of the horizontal antenna. The top guy plate should be positioned so that the odd hole will face toward the direction of the antenna when the mast assembly is raised.

- (2) Add the base insulator to the swivel stake and then add the mast sections one by one until five sections have been assembled. Allow the mast sections to rest on the ground.
- (3) Place a guy plate on the male end of the fifth section.
- (4) Add five more mast sections to the first five sections and place a second guy plate on the male end of the tenth mast section.
- (5) Add the last 6 sections to the first 10 and place the third guy plate on the last section.
- (6) If the 55-foot antenna is being used, add the whip adapter to the last mast section. Add the standard whip

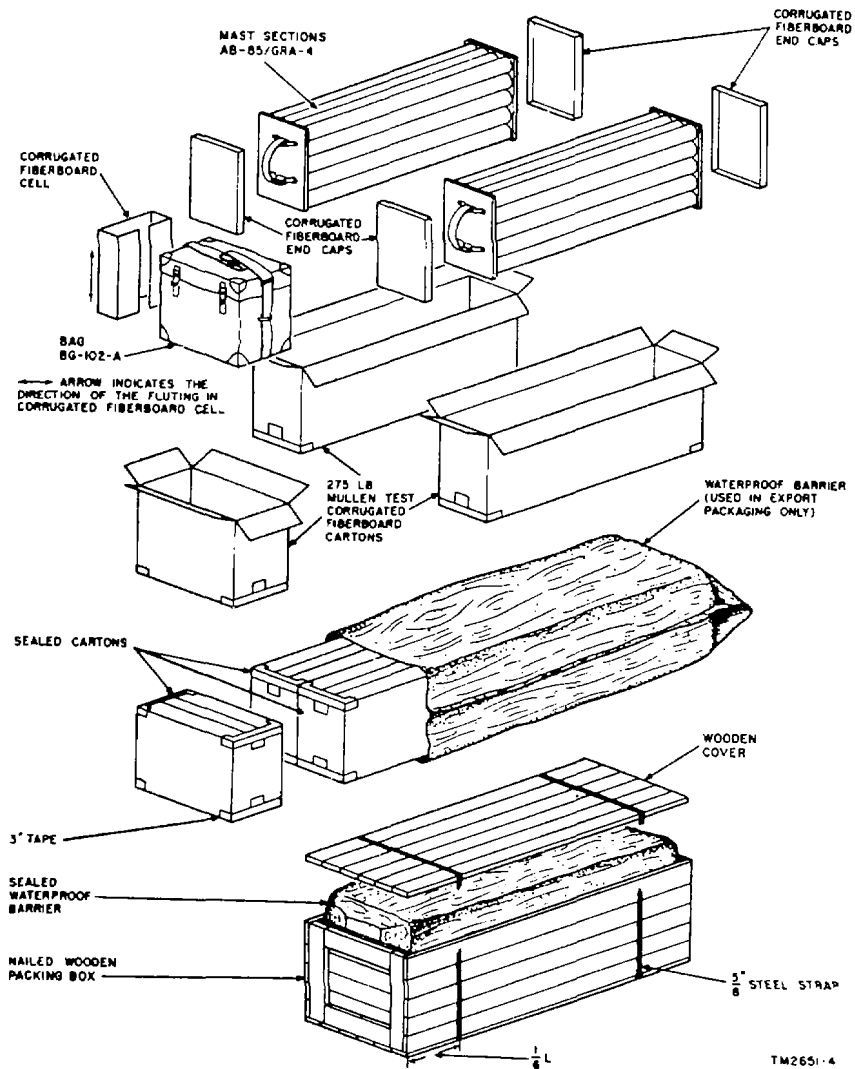

Figure 11. Packaging of Antenna Group AN/GRA-4.

antenna which consists of three Mast Sections MS-116, one MS-117, and MS-118 in that order.

Note. The whip antenna is not supplied with this equipment.

c. *Stakes.* The four stakes should be located 25 feet from the swivel stake and approximately 90' apart. Note that the letters assigned to the stakes in figures 13 and 14 and in the text below are inserted for purposes of illustration only and are not markings on the equipment.

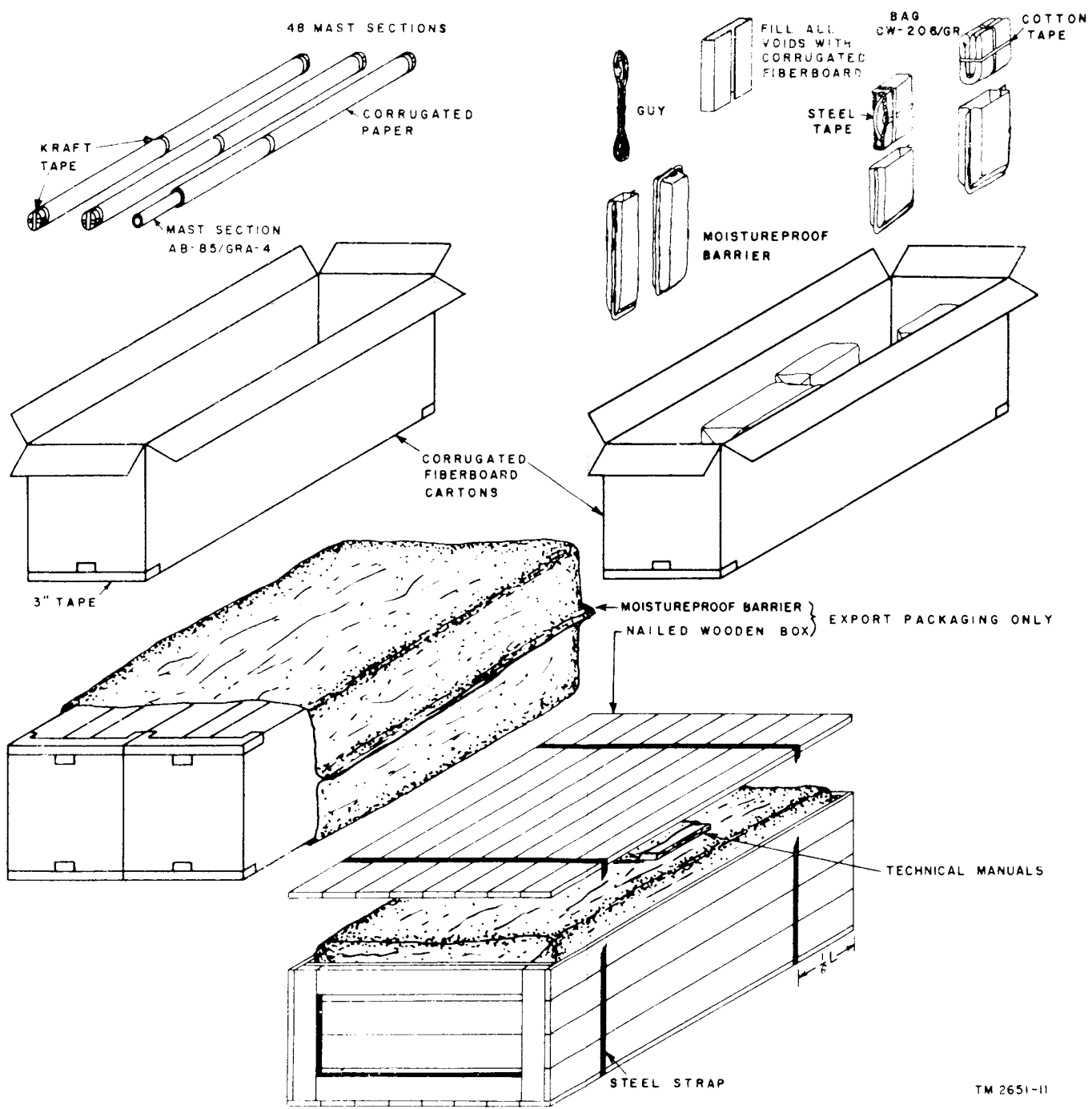

Figure 12. Packaging of Antenna Group AN/GRA-12

- (1) Drive in stake A at the junction of the 10th and 11th mast sections. Tilt the stake away from the swivel stake at an angle of approximately 30'.
- (2) Measure the distance between the swivel stake and stake A. Use a guy or the measuring tape.
- (3) Use this measurement and locate stakes B and C about 90° on either side of the swivel stake.
- (4) Drive in each stake at a 30' angle to the swivel stake.
- (5) Use the same measurement and locate stake D 90° from stakes B and C.
- (6) Drive in stake D at a 30' angle.

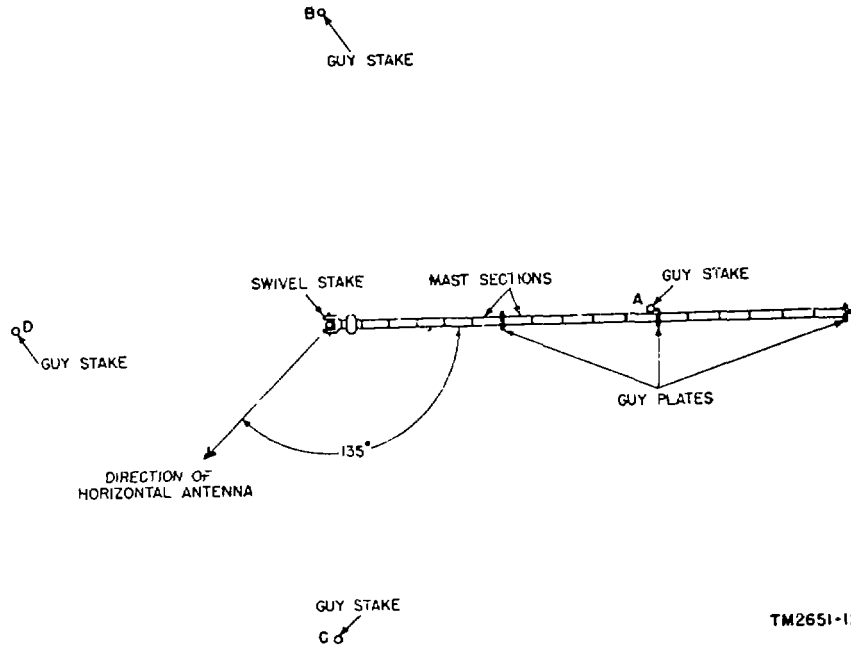

Figure 13. Assembling mast sections and positioning stakes.

d. *Guys* (fig. 14). The guys are color-coded for immediate identification: top, red; center, white; lower, blue. Each guy plate has four holes 90° apart for attaching the guys. A fifth hole is provided for connection of a halyard and should be kept in the direction of the antenna when the halyard is to be used. Connect the guys as follows:

- (1) Connect the guys for stake A first. Attach the snap hook of each guy to the corresponding hole of the proper guy plate.

- (2) Stretch the guys out to stake B to measure for the correct adjustment. Adjust each guy by means of Fastener FT-9.
- (3) Carry the free end of each guy back to stake A and fasten it, be careful not to tangle the ropes.
- (4) Attach the guys for stakes B and C. Attach each set of guys to the corresponding holes of the guy plates and to stakes B and C; make the proper adjustment with the fittings. When tightening the guys, do not bend the mast pole.
- (5) Connect three guys for stake D to the corresponding guy plates, and stretch the guys along the mast toward stake D. If a halyard is used, fasten the halyard pulley to the fifth hole of the top guy plate, and tie the two ends of the halyard together to prevent the halyard from running through the pulley.

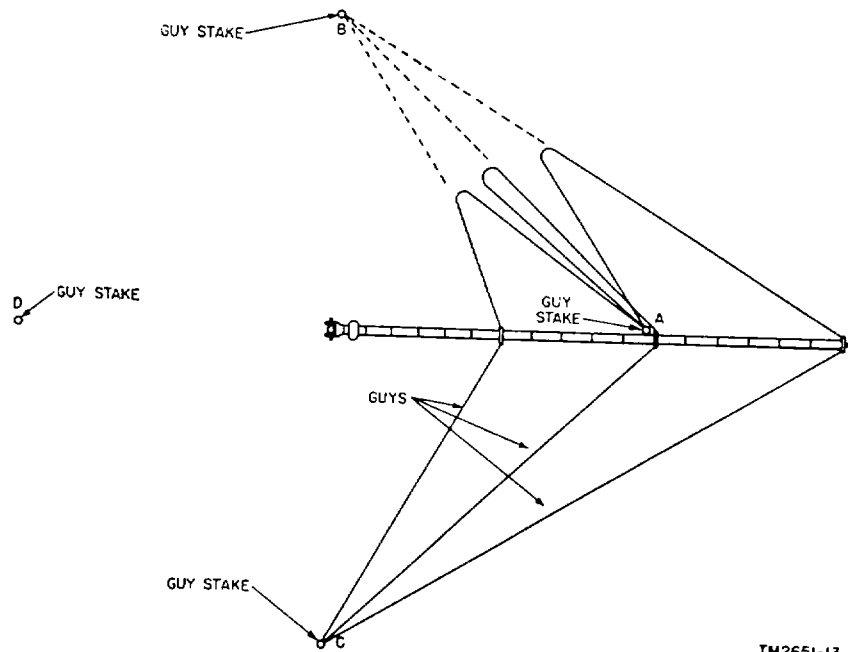

Figure 14. Attaching guys.

16. Raising Mast

- a. Two men are required to raise the mast. One man stands near the swivel stake, holding the halyard, if used, and the three free guys. The second man takes his position at the far end of the mast pole.

b. The first man pulls on the free set of guys, being sure to keep more tension on the top guy so that the mast bows slightly. At the same time, the second man raises the end of the mast.

c. The first man walks toward stake D while pulling on the guys. At the same time, the second man walks toward the swivel stake, raising the mast pole as he goes.

d. When the mast is upright and the slack set of guys has become taut, the second man assists the first in ~~searing~~ securing and adjusting the free set of guys to stake D. The halyard, if used, should be released and allowed to hang freely at the mast.

e. If further adjustment is necessary to bring the mast more nearly vertical, first slack off the guys which are too short, then tighten the guys that are too long, and finally tighten the guys that were slacked off.

f. If the mast assembly is to be used as a vertical radiator (fig. 16), use the counterpoise. Place the counterpoise at the base of the mast assembly and attach the four radials to the stakes. Connect the lead-in wire of the counterpoise to a good ground. The binding post of the tuning unit or the ground used with the associated radio set may be used. If available, a long metal stake driven into the ground can be used. Attach the lead-in wire from the radio set or tuning unit to the binding post on the top of the base insulator.

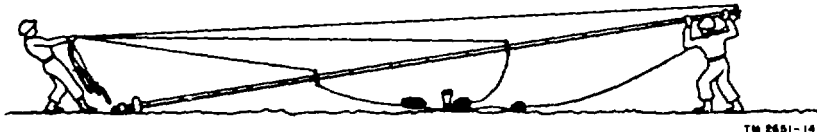

Figure 15. Raising mast.

17. Determining Length of Antenna

a. Table II lists the different lengths of antenna to be used with various frequencies. Refer to paragraph 32 for a discussion of the theory related to antenna length.

Table II. Half-Wave Antenna Length

Freq (mc)	Length		Freq (mc)	Length		Freq (mc)	Length	
	(ft)	(in.)		(ft)	(in.)		(ft)	(in.)
1.5	312	0	5.6	81	1	9.7	45	1
1.6	292	6	5.7	79	7	9.8	44	7
1.7	275	4	5.8	78	2	9.9	44	1
1.8	260	0	5.9	76	10	10.0	43	8
1.9	246	4	6.0	75	5	10.1	43	2
2.0	234	0	6.1	74	1	10.2	42	10
2.1	222	11	6.2	72	11	10.3	42	5
2.2	212	8	6.3	71	8	10.4	42	0
2.3	203	6	6.4	70	6	10.5	41	7
2.4	194	10	6.5	69	4	10.6	41	2
2.5	186	10	6.6	68	2	10.7	40	8
2.6	179	6	6.7	67	1	10.8	40	4
2.7	172	8	6.8	66	0	10.9	40	0
2.8	166	5	6.9	65	0	11.0	39	7
2.9	160	6	7.0	64	0	11.1	39	2
3.0	155	0	7.1	63	1	11.2	38	11
3.1	150	0	7.2	62	2	11.3	38	6
3.2	145	0	7.3	61	4	11.4	38	2
3.3	140	6	7.4	60	5	11.6	37	11
3.4	136	4	7.5	59	6	11.6	37	6
3.5	132	4	7.6	58	8	11.7	37	2
3.6	128	6	7.7	67	11	11.8	36	11
3.7	124	11	7.8	57	1	11.9	36	7
3.8	121	6	7.9	56	4	12.0	36	4
3.9	118	4	8.0	55	6	12.1	36	0
4.0	115	4	8.1	54	10	12.2	35	8
4.1	112	4	8.2	54	1	12.3	35	5
4.2	109	5	8.3	53	5	12.4	35	1
4.3	106	10	8.4	52	8	12.5	34	10
4.4	104	4	8.5	62	0	12.6	34	7
4.5	101	11	8.6	61	5	12.7	34	4
4.6	99	7	8.7	50	10	12.8	34	0
4.7	97	5	8.8	50	2	12.9	33	10
4.8	95	4	8.9	49	6	13.0	33	6
4.9	93	4	9.0	48	11	13.1	33	2
5.0	91	5	9.1	48	4	13.2	33	0
5.1	89	6	9.2	47	8	13.3	32	8
5.2	37	8	9.3	47	2	13.4	32	6
5.3	86	0	9.4	46	8	13.5	32	4
5.4	84	4	9.5	46	1	13.6	32	0
5.5	82	8	9.6	45	7	13.7	31	10
13.8	31	7	15.3	28	6	16.8	26	0
13.9	31	4	15.4	28	4	16.9	25	10
14.0	31	1	15.5	28	1	17.0	25	7
14.1	30	11	15.6	27	11	17.1	25	6
14.2	30	8	15.7	27	8	17.2	25	4
14.3	30	6	15.8	27	7	17.3	25	2
14.4	30	2	15.9	27	5	17.4	25	0
14.5	30	0	16.0	27	2	17.6	24	10

Table II. Half-Wave Antenna Length-Continued

Freq (mc)	Length		Freq (mc)	Length		Freq (mc)	Length	
	(ft)	(in.)		(ft)	(in.)		(ft)	(in.)
14.6	29	10	16.1	27	1	17.6	24	8
14.7	29	7	16.2	27	0	17.7	24	7
14.8	29	5	16.3	26	10	17.8	24	6
14.9	29	2	16.4	26	7	17.9	24	6
15.0	29	0	16.5	26	5	18.0	24	4
15.1	28	10	16.6	26	2			
15.2	28	7	16.7	26	1			

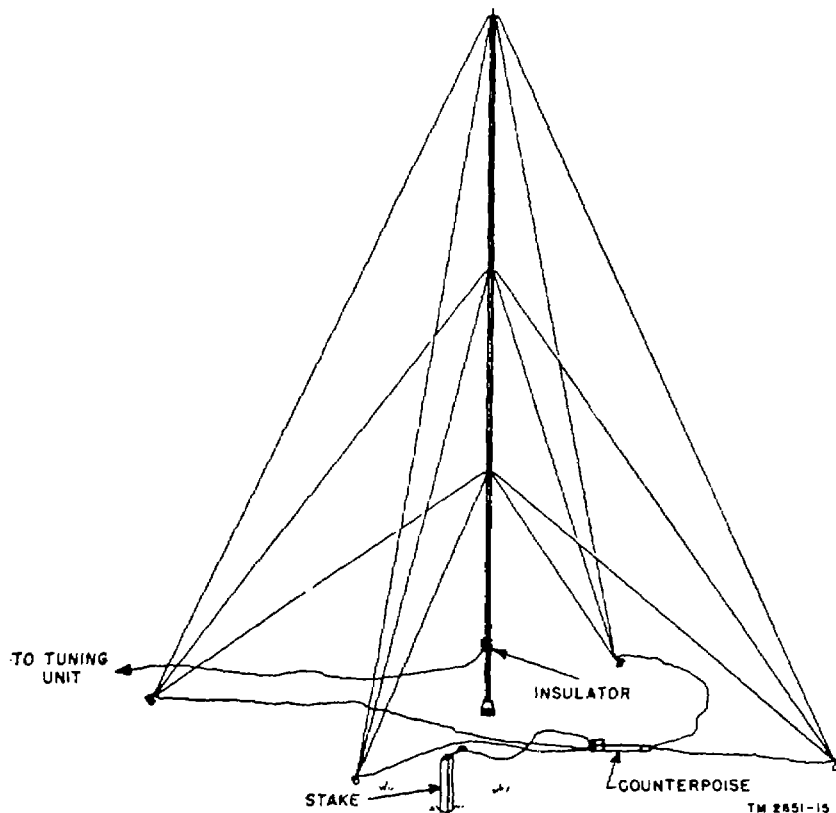

Figure 16. Mast assembly installed as a vertical radiator.

b. The following chart lists the points of measurement for the various types of horizontal antenna.

Type	Measure
Slanting wire	From junction of reel and halyard to radio set or tuning unit binding post
L-type, off-center-fed Hertz, or center-fed Hertz.	From one halyard fastener to other halyard fastener.

18. Installing Antenna, Using Antenna Group AN/GRA-4

a. *Slanting Wire Antenna* (fig. 6).

- (1) *General.* The slanting wire antenna is usually one-half wave length long. Refer to paragraphs 12 and 13 for information on locating and siting the antenna and to table II for the proper length. When measuring the length, be sure to start at the transmitter, receiver, or tuning unit binding post and include the lead-in wire.
- (2) *Procedure.* After the direction and location of the antenna have been chosen, install the antenna as follows:
 - (a) If the 40-foot mast assembly is to be used as the support, locate the mast about one-half wave length from the transmitter or receiver and erect the mast assembly (pars. 15 and 16). Fasten the halyard to the top guy plate before raising the mast assembly.
 - (b) If a tree or similar support is used, first attach the pulley on the halyard to the support at the desired height. Locate the transmitter, receiver, or tuning unit approximately one-half wave length from the support.
 - (c) Fasten the antenna wire termination to the lead-in wire or tuning unit. Connect the lead-in wire or the tuning unit to the radio set.
 - (d) Fasten the insulator end of a second halyard about 6 inches from the end of the antenna wire (fig. 17), and secure the halyard to a stake or to the transmitter or receiver. Adjust the halyard to take all the strain of holding the antenna wire tightly. Allow the lead-in wire to sag, but do not allow it to touch the ground at any point.
 - (e) Unwind the wire of the antenna reel as follows (fig. 18):
 1. Grasp the reel firmly in one hand and loosen the thumb nut at the center of the reel and on the wire clamp.
 2. Remove the wire from the clamp.
 3. Walk slowly away from the transmitter, keeping the wire taut at all times. Hold your thumb on the wire to prevent backlash.
 - (f) With the measuring tape, measure off the length of wire obtained in table II.

Note. The tape should be wiped off after use to prevent dirt and sand from entering and clogging the reeling mechanism.

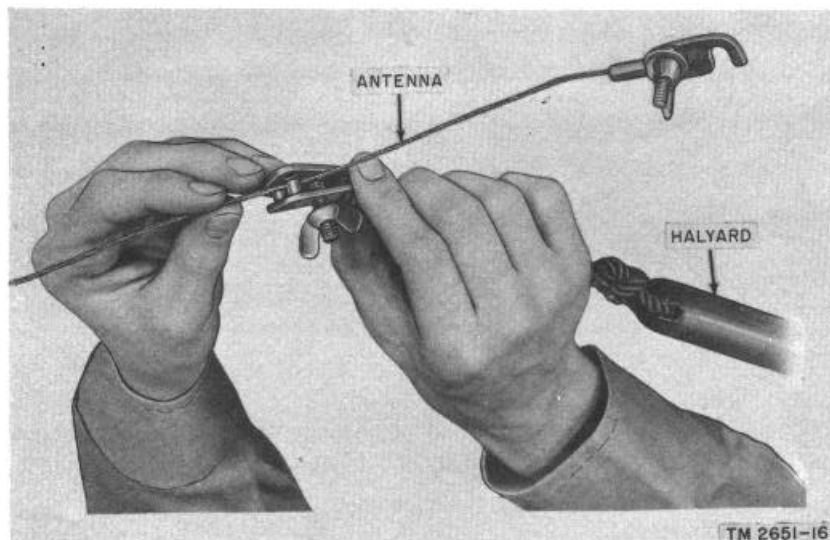

Figure 17. Attaching halyard to antenna wire.

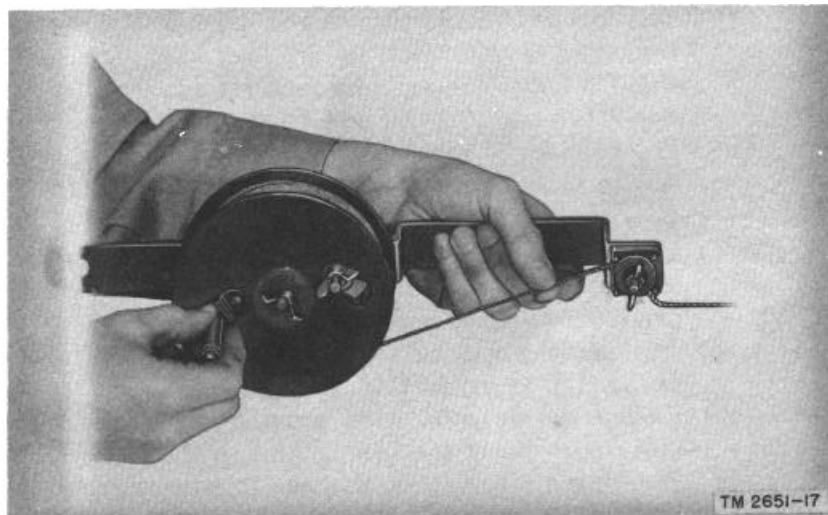

Figure 18. Unwinding antenna wire from reel.

- (g) Replace the wire in the wire clamp and tighten the thumb nut.
- (h) Tighten the thumb nut at the center of the reel.
- (i) Attach the insulator end of the other halyard to the reel (fig. 19).

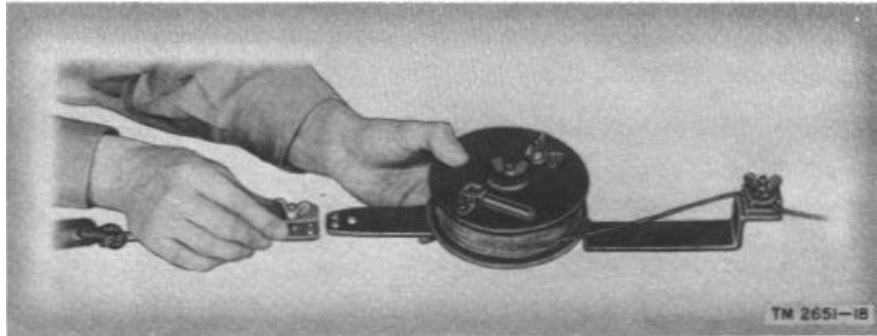

Figure 19. Attaching halyard to reel.

- (j) Pull the free end of this halyard to raise the antenna and secure the halyard to a guy stake.

b. L-Type Antenna (fig. 7).

(1) *General.*

- (a) The L-type antenna (par. 12c(2)) operates most efficiently at 5.6 me, having a down lead of 40 feet and the horizontal portion of the antenna equal to 80 feet. Refer to paragraph 13 for siting, and refer to table II to obtain the required length.
- (b) The L-type antenna is not recommended for use on frequencies higher than 5.8 mc. For frequencies above 3.1 me, one antenna reel is used. For frequencies lower than 3.1 mc, remove the wire from one reel and connect it in series with the wire on a second reel to make up the required length (fig. 20).

(2) *Procedure.*

- (a) Erect the two 40-foot mast assemblies or one mast assembly and a similar support one-half wave length plus 20 feet apart (paras. 15 and 16).
- (b) Fasten the pulley of a halyard at a height of 40 feet to the similar support, if used.
- (c) Fasten the antenna wire termination to the tuning unit and connect the tuning unit to the radio set.
- (d) Starting at the end of the lead-in wire, measure and unwind 40 feet of wire for the down lead (2) (e) above). At this point, attach the fastener of the near halyard insulator to the antenna wire (fig. 17).
- (e) Unwind the antenna wire until the length from one halyard fastener to the other is one-half wave length (table II). If necessary, use the wire from two reels by removing the wire from one reel and attaching it to the wire on a second reel (fig. 20).

Note. To remove the wire from a reel, loosen the off-center thumb nut on the reel, slide the thumb nut and the wire termination toward the adjacent hole (fig. 18). Slip the nut through the hole and remove the wire from the reel. To rewind the wire on the reel, refer to paragraph 34a(1) (d).

- (f) Place the wire in the wire clamp and tighten the thumb nut of the clamp and the nut at the center of the reel.
- (g) Fasten the remaining halyard insulator to the reel (fig. 19).
- (h) Raise the antenna by pulling the free end of each halyard until the antenna wire is taut. Tie each halyard to a guy stake or other device if a similar support is used.

c. *Off-Center-Fed Hertz Antenna* (fig. 8).

- (1) *General.* The off-center-fed Hertz antenna is a half-wave antenna which uses a single wire feeder. The impedance of a single wire feeder is approximately 500 ohms. The feeder should be connected to the

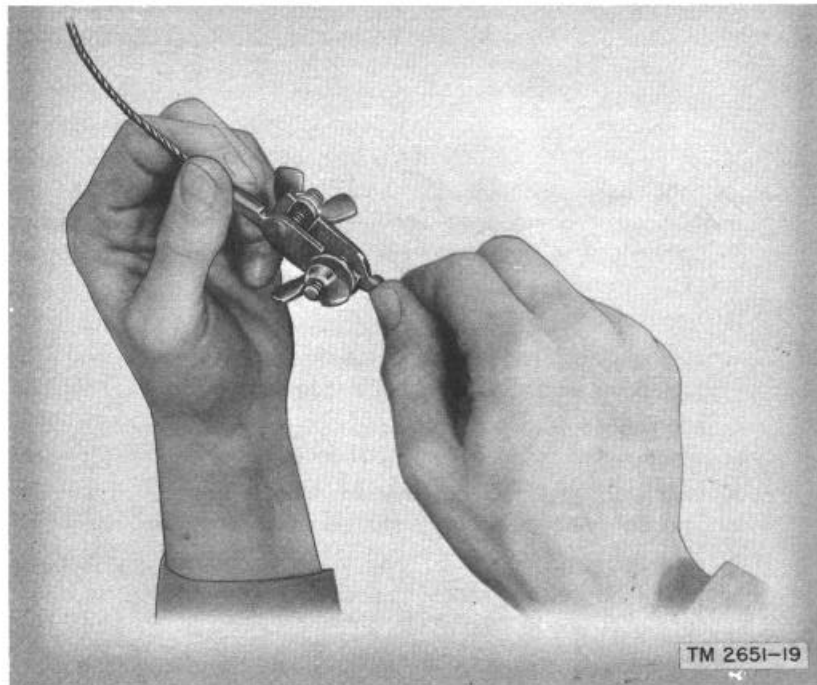

Figure 20. Connecting antenna wire from two reel assemblies.

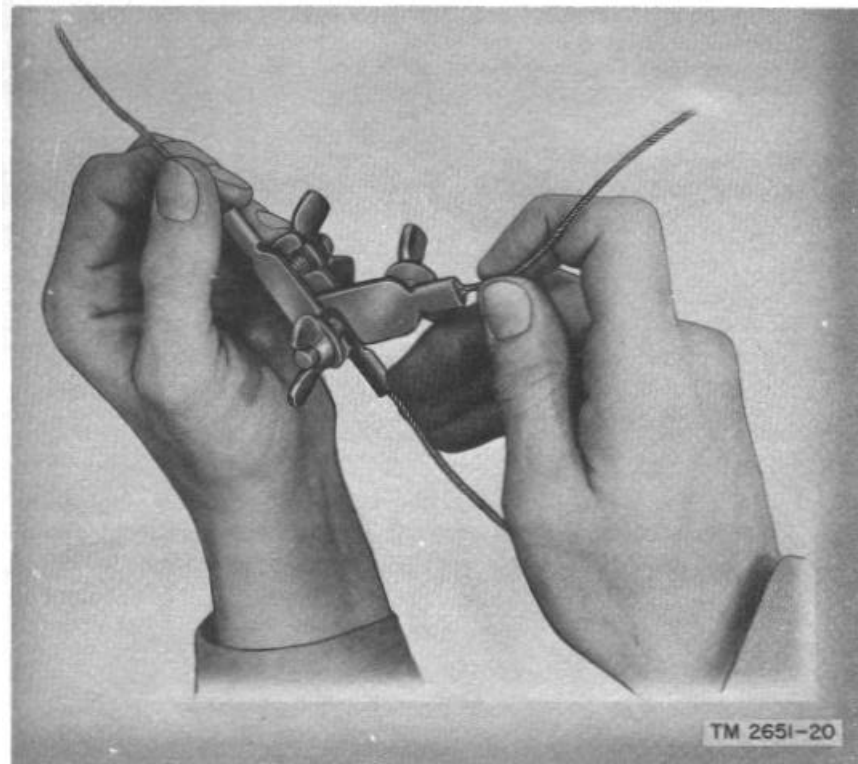

Figure 21. Connecting the antenna wire from three reel assemblies.

antenna at a 500-ohm point. This point can be found by multiplying the antenna length (table II) by .361. The result is the number of feet from either end of the antenna to this point where the feeder should be connected. Refer to table I for siting.

(2) *Procedure.*

- (a) Erect the two 40-foot mast assemblies, with halyards, one-half wave length plus 20 feet apart (paras. 15 and 16).
- (b) Fasten the wire terminations of three antenna reels together (fig. 21). Two of the wires serve as the antenna, and the third serves as the feeder.
- (c) Unwind and measure one wire to obtain the length to the 500-ohm point ((1) above). This is the shorter side of the antenna.
- (d) Unwind the second wire until the length of the first wire plus the second wire equals one-half wave length (table II).

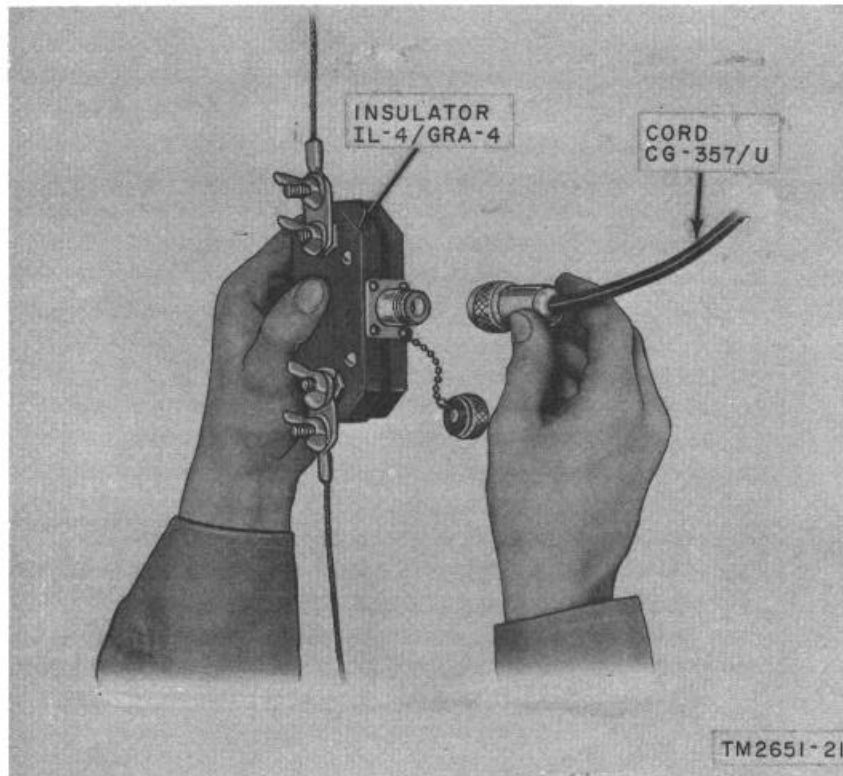

Figure 22. Connections to Insulator IL-4/GRA-4.

- (e) Unwind 40 feet of wire from the third reel.
- (f) Place each wire in its corresponding wire clamp and tighten all thumb nuts.
- (g) Fasten the first and second reels to the insulator end of the respective mast halyards (fig. 19).
- (h) Pull the free end of each halyard until the antenna is raised. Secure each halyard to the guy fastener at one of the stakes.
- (i) Fasten the insulator end of a third halyard to the third reel and secure the halyard to the transmitter, receiver, or to a stake in the ground. Adjust the length of the feeder to remove all slack.
- (j) Fasten one end of the insulated lead-in wire of the tuning unit lead-in under the thumb nut on the reel wire clamp. Connect the other end of the tuning unit lead-in to the transmitter or receiver binding post.

d. Center-Fed Hertz (Doublet) Antenna (fig. 9).

- (1) *General.* The center-fed Hertz (doublet) antenna is a half-wave antenna fed at the center by means of a

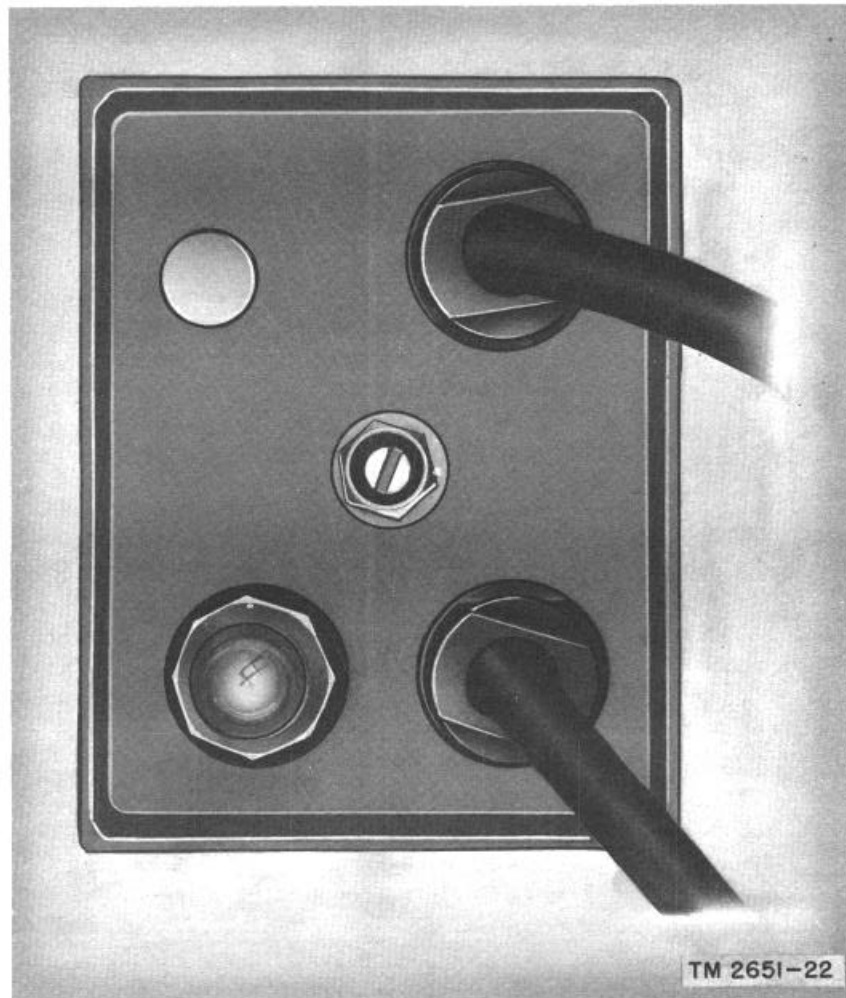

Figure 23. Tuner TN-174/GRA-4, front view.

coaxial cable of 72 ohms impedance. Refer to table I for siting.

(2) *Procedure.*

- (a) Erect the two 40-foot mast assemblies, with halyards, one-half wave length plus 20 feet apart (paras. 15 and 16).
- (b) Connect the wire terminations of the two reel assemblies to Insulator IL-4/GRA-4 by means of the thumb nuts on the insulator (fig. 22).
- (c) Attach Cord CG-357/U to the coaxial connector in the insulator.

- (d) Unwind and measure each antenna wire to a length equal to slightly less than one-half the value obtained from table II.
- (e) Check the overall length of the two wires plus the insulator. Adjust if necessary, and be sure to keep the insulator centered.
- (f) Attach each reel to the insulator of the respective mast halyard (figs. 9 and 19).
- (g) Raise the antenna by pulling the free end of each halyard. Secure each halyard to the guy fastener of a ground stake.
- (h) Connect enough coaxial cable to the coaxial feed to reach the transmitter.

e. *Tuning Unit.* Tuner TN-174/GRA-4 (fig. 23) is used with slanting wire antennas (fig. 6). To connect the tuning unit, proceed as follows (refer to a above):

- (1) Attach the tuner lead-in wire to the antenna wire termination.
- (2) Attach the connecting wire from the transmitter or receiver to the other tuner lead-in wire.

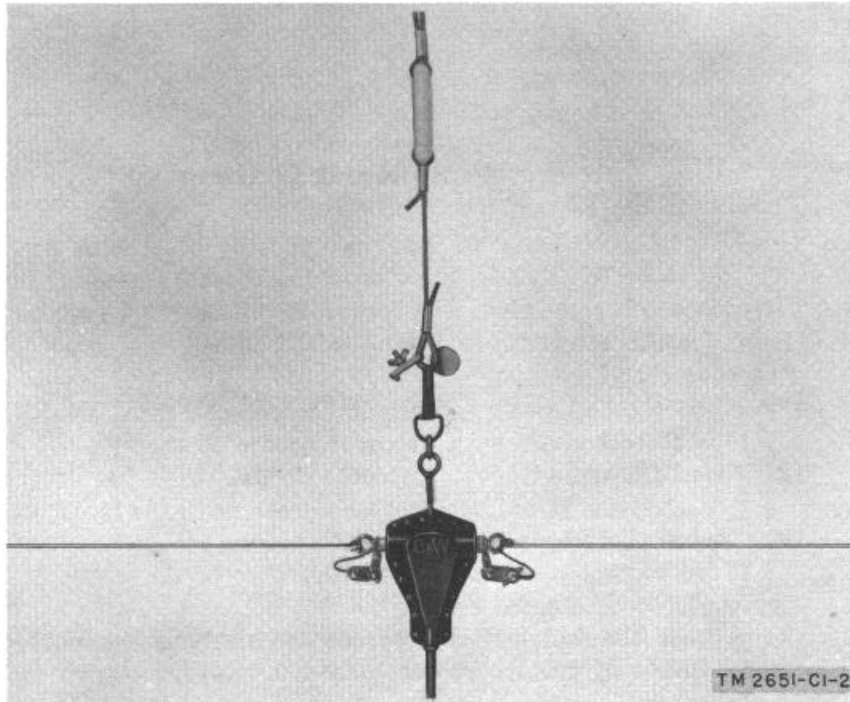

Figure 24. Connections to RF Cable Assembly CG-692/U.

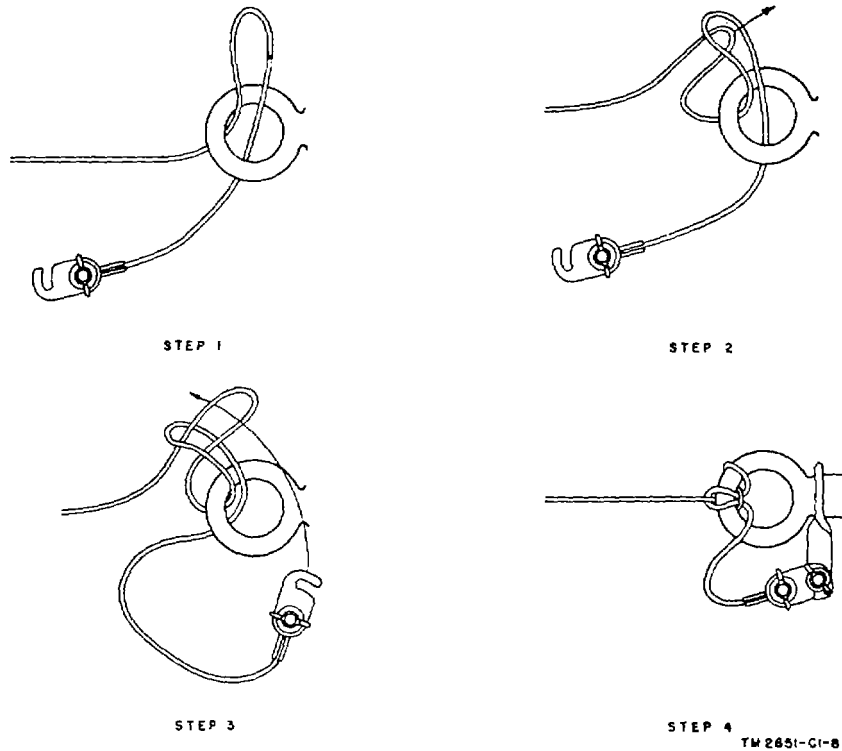

Figure 25. Details of tying wire to insulator.

19. Installing Antenna, Using Antenna Group AN/GRA-1 2

a. *General.* The only type of antenna normally built with Antenna Group AN/GRA-12 is the center-fed Hertz antenna. It is a half-wave antenna fed at the center by means of a coaxial cable having a characteristic impedance of 52 ohms.

b. *Procedure.*

- (1) Erect the two end mast assemblies one-half wave length plus 20 feet apart with halyards paras. 15 and 16).
- (2) Erect the center mast assembly in line with the other two and exactly halfway between them with the halyard.
- (3) Fasten the wire terminations of the two reel assemblies to the cable assembly by tying the wire to the insulator as shown in figures 24 and 25.
- (4) Attach the halyard of the center mast to the cable assembly by means of one hook assembly as shown in figure 25
- (5) Unwind and measure each antenna wire to a length slightly less than one-half the value obtained from table II.

- (6) Check the overall length of the two wires plus the connector. Adjust it if necessary; be sure to keep the connectors and the RF cable assembly centered by raising halyard of the center mast first.
- (7) Attach each reel to the insulator of the respective mast halyard (fig. 19).
- (8) Raise the antenna by pulling the free end of each halyard. Secure each halyard.

20. Tuner TN-174/GRA-4 Control

The tuning unit (fig. 26) has a single tuning capacitor, which is used to adjust the reactance of the feeder line. A neon bulb indicates resonance during antenna loading. When using the tuning unit for transmitting or receiving, adjust the tuning control slowly until the neon bulb glows at maximum brilliance.

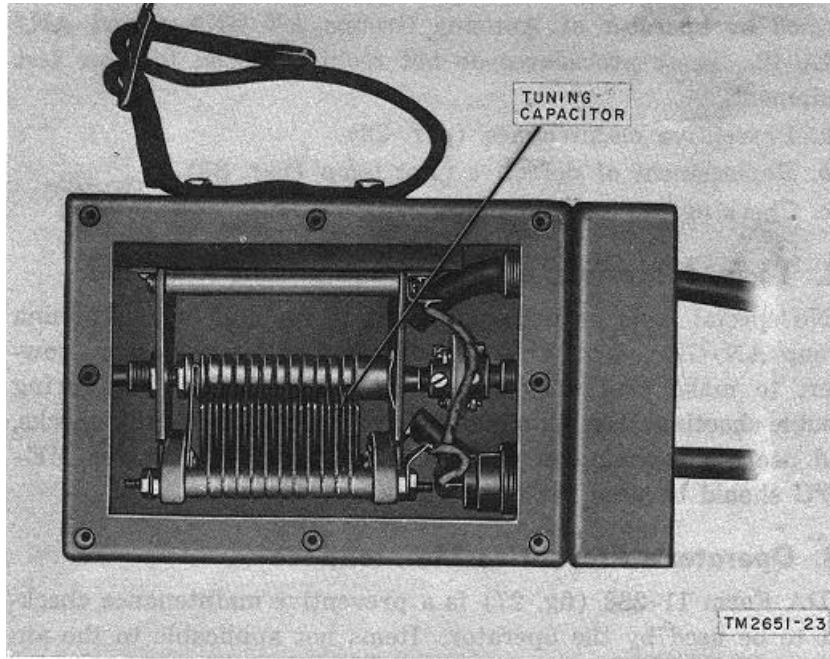

Figure 26. Tuner TN-174/GRA-4, interior view.

CHAPTER 3

ORGANIZATIONAL MAINTENANCE

Note. Organizational maintenance is performed at first and second echelon. First echelon maintenance is operators maintenance; second echelon maintenance is unit repairmen's maintenance.

Section I. FIRST ECHELON (OPERATOR) MAINTENANCE

21. Scope of Operator's Maintenance

The following is a list of maintenance duties normally performed by operator of Antenna Groups AN/GRA-4 and AN/GRA-12. These procedures do not require special tools or test equipment.

- a. Preventive maintenance (par. 23).
- b. Replacement of defective pilot lamp (par. 30).
- c. Checking cable connections.

22. Tools, Materials, and Test Equipment Required

No special tools or test equipment is supplied with Antenna Group AN/GRA-4 or AN/GRA-12.. It may be necessary, however, to make continuity checks or an insulation test during trouble shooting. Use an ohmmeter for making continuity checks, and use a megohmmeter for insulation tests. Multimeter ME-77/U should be used for these checks.

23. Operator's Preventive Maintenance

DA Form 11-238 (fig. 27) is a preventive maintenance checklist to be used by the operator. Items not applicable to the antenna group are lined out in the figure. Instructions for the use of the form appear on the back of the form.

Warning. Prolonged breathing of cleaning compound fumes is dangerous. Make sure that adequate ventilation is provided. Cleaning compound is flammable; do not use near a flame.

OPERATOR FIRST ECHELON MAINTENANCE CHECK LIST FOR SIGNAL CORPS EQUIPMENT						
WAB:0 COMMUNICATION, DIRECTION FINDING, CARRIER, BROADCAST						
INSTRUCTIONS: See other side						
EQUIPMENT IDENTIFICATION ANTENNA GROUPS AN/GRA-4 AND AN/GRA-12				EQUIPMENT SERIAL NO.		
LEGEND FOR MARKING CONDITIONS: ✓ Satisfactory, ✗ Adjustment, repair or replacement required, ⊕ Defect corrected.						
NOTE: Strike out items not applicable.						
DAILY						
NO.	ITEM	CONDITION				
		S	W	T	U	P
1	COMPLETENESS AND GENERAL CONDITION OF EQUIPMENT	✓				
2	CLEAR BIRT AND WHISTLE FROM ANTENNA	✓				
3	INSPECT CONTROLS FOR BONDING, SCRAPPING, EXCESSIVE LOOSENESS, OR POSITIVE ACTION.	✓				
WEEKLY						
NO.	ITEM	DAYS	NO.	ITEM	DAYS	
						NO.
1	CLEAN AND TIGHTEN ANTENNA AND COAXIAL TRANSMISSION LINES, AND CABLE CONNECTIONS.	✓	13	INSPECT ANTENNA AND COAXIAL TRANSMISSION LINES, AND CABLE CONNECTIONS.		
2	INSPECT ANTENNA, ANTENNAS, POWER AND EXPOSED METAL SURFACES, FOR PEST, CORROSION, AND MOISTURE.	✓	14	INSPECT ANTENNA AND COAXIAL TRANSMISSION LINES, AND CABLE CONNECTIONS.		
3	INSPECT CORD, CABLE, WIRE, AND CONNECTIONS FOR CUTS, BREAKS, FRAYING, DETERIORATION, KINKS, AND STRAIN.	⊕	15	INSPECT ANTENNA AND COAXIAL TRANSMISSION LINES, AND CABLE CONNECTIONS.		
4	INSPECT ANTENNA FOR ECCENTRICITIES, CORROSION, LOOSE FIT, DAMAGED INDICATORS AND CONNECTIONS.	✓	16	INSPECT ANTENNA AND COAXIAL TRANSMISSION LINES, AND CABLE CONNECTIONS.		
5	INSPECT ANTENNA AND COAXIAL TRANSMISSION LINES, AND CABLE CONNECTIONS.		17	CHECK ANTENNA GUN WRES FOR LOOSENESS AND PROPER TENSION.		
6	INSPECT FOR LOOSENESS OF ACCESSORY ITEMS: ANTENNAS, CONNECTORS, MECHANICAL TRANSMISSION, AND PILOT LIGHT ASSEMBLIES.	✓	18	CHECK ANTENNA AND COAXIAL TRANSMISSION LINES, AND CABLE CONNECTIONS.		
19 IF DEFICIENCIES NOTED ARE NOT CORRECTED DURING INSPECTION, INDICATE ACTION TAKEN FOR CORRECTION.						

DA FORM 11-238

REPLACES DA FORM 11-238, 1 DEC 50, WHICH IS OBSOLETE.

TM2651-31

Figure 27. DA Form 11-238.

24. Visual Inspection

Check all the electrical connections for tightness, and check the lead-in wires for possible short or open circuits. Check insulators for cracks, chips, or other defects.

Section II. SECOND ECHELON (UNIT REPAIRMAN) MAINTENANCE

25. Scope of Unit Repairman's Maintenance

The following is a list of maintenance duties performed by the unit repairman for Antenna Groups AN/GRA-4 and AN/GRA-12. The scope of these instructions has been determined by the available tools, materials, test equipment, spare parts and the MOS of the unit repairman.

- a. Preventive maintenance (par. 27).
- b. Troubleshooting (par. 29).
- c. Replacement of parts (par. 30).

26. Tools, Materials, and Test Equipment Required

The tools, materials and test equipment required for unit repairman's maintenance are listed below.

- a. *Tools.* Tool Equipment TE-41 is required for unit repairman's maintenance.

- b. *Materials.*

Cleaning Compound (Federal stock No. 7930-395-9542)

Cheesecloth, lint-free*

Sandpaper, No. 000*

- c. *Test Equipment.* Multimeter ME-77/U is used for testing.

27. Unit Repairman's Preventive Maintenance

DA Form 11-239 (fig. 28) is a preventive maintenance check list to be used by the unit repairman. Items not applicable to the equipment are lined out in the figure. References in the ITEM block in the figure are to paragraphs that contain additional maintenance information pertinent to the particular item. Instructions for the use of the form appear on the back of the form.

Warning. Disconnect all power before performing preventive maintenance. When power to the equipment is disconnected, the antenna tuning capacitor may retain voltage of dangerous potential. Before touching exposed electrical parts, short-circuit the part to ground. When maintenance is completed, reconnect the power, and check for satisfactory operation.

28. Unit Repairman's Visual Inspection

Before operating the equipment, inspect the following for obvious defects:

- a. Check the capacitor and pilot light on the antenna tuner for looseness.

*Part of Tool Equipment TE-41.

- b. Check the transmission line from the radio set to the antenna.
- c. Check the mast assemblies for any damage or weakness caused by rain, wind, storms, etc.
- d. Check all connections between the radio set and antenna.

29. Troubleshooting

Shut down the power at the transmitter-receiver; disconnect the power end of the lead-in wire, and proceed as follows:

- a. *No Output.* Lack of output usually is caused by a short or an open circuit.
 - (1) *Mast assembly.*
 - (a) If the mast assembly is used as a vertical radiator, check for continuity at the junction between the lead-in wire and the lowest mast section; use the low scale of the ohmmeter. The reading should be close to zero.
No reading or a high reading indicates that the lead-in wire is open or defective and must be repaired or replaced.
 - (b) Check continuity through each mast section. A high reading indicates poor contact, probably caused by corrosion. If the mast sections need cleaning, disassemble the mast sections (para. 34) and remove corrosion with No. 000 sandpaper.
 - (2) *Antenna assembly.* Use the low scale of the ohmmeter and check continuity between the lead-in wire and the radiating components. If Cord CG-357/U or RF Cable Assembly CG-692/U is used, check the continuity from both conductors. The reading should be close to zero. A higher reading probably indicates a defective cord. Replace the cord.
- b. *Weak Output.* Weak output may be caused by poor adjustment of the tuning unit, a poor connection, or leakage. Check the adjustment of the tuning unit (par. 20). Check all components for natural obstructions which may form a path to ground (foliage, fungus, etc). Check all connections for tightness and all insulators for leakage.

Note. A weak output also may be caused by incorrect installation. Check measurements made in determining the length of the antenna (table II).

- (1) *Mast Assembly.* Make the checks outlined in a(1) above.
- (2) *Antenna assembly.*
 - (a) Use the low scale of the ohmmeter and check the continuity between the lead-in wire and the radiating components. If Cord CG-357/U or RF Cable Assembly CG-692/U is used, check the

continuity from both conductors to the radiating components. The reading should be close to zero. A higher reading probably indicates corrosion of the radiating elements or coaxial fittings. Clean the antenna wire and the fittings.

Note. Disconnect the cord before making the following measurement.

- (b) Use the multimeter to check the insulation resistance between the inner and outer conductors of Cord CG-357/U or RF Cable Assembly CG-692/U. The reading should be at least 10 megohms. If the reading is 0, the cord is probably defective. If the reading is less than 10 megohms but well above 0, lower the antenna, remove the cord from the insulator, and test the insulator, cord, and radiating components separately.

30. Replacement of Parts

a. *Mast Assembly.* If any component of the mast assembly becomes defective, replace it with a new component from the spare parts.

b. *Antenna Tuner.*

- (1) The only readily replaceable part of the antenna tuner is lamp bulb E1 in the tuning unit. Replace as follows:
 - (a) Unscrew the knurled jewel lens on the front of the tuning unit.
 - (b) Unscrew the bulb and replace it with a new one.
 - (c) Replace the lens.
- (2) The only item of the antenna tuner which can be readily repaired is the coaxial cable (fig. 29).
- (3) Radio Frequency Cable RG-59A/U has four layers—an outer jacket, copper braid, polyethylene insulation, and a copper conductor. To install a connector on the end of a cable, proceed as follows:
 - (a) Remove 3/4 inch of the outer jacket.
 - (b) Disassemble the connector (fig. 29).
 - (c) Slide the threaded nut over the cable.
 - (d) Slide the thin washer over the cable.
 - (e) Slide the rubber gasket over the cable, allowing 1/16 inch of the outer jacket to protrude.
 - (f) Slide the chamfered sleeve over the copper braid.
 - (g) Flare the braid around the sleeve.
 - (h) Remove the excess braid so that it is even with the outer edge of the chamfer.
 - (i) Bare the conductor by removing 3/16 inch of insulation from the end of cable.

- (j) Slide the contact over the conductor and solder through the solder hole; file smooth.
- (k) Insert the cable into the assembly shell.
- (l) Tighten the nut securely. When the cable and connector are properly assembled, the socket tip should be flush with, or not more than 1/32 inch beneath, the edge of the coupling.

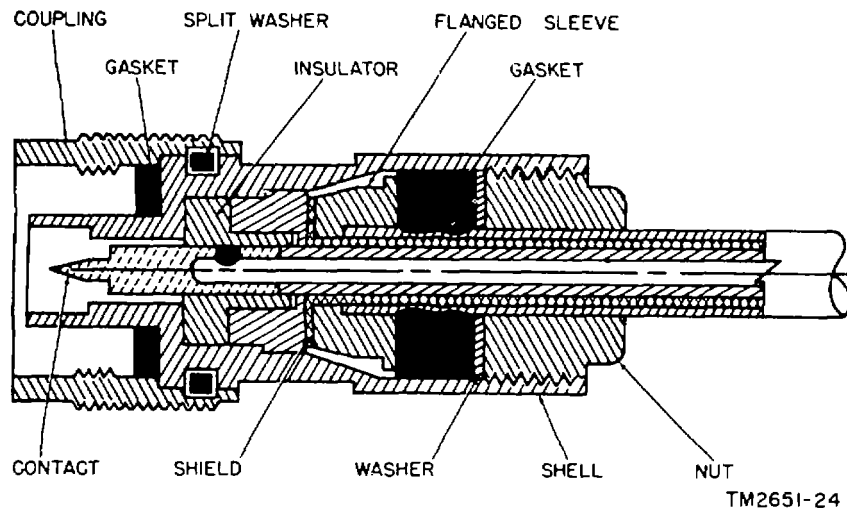

Figure 29. Cross section of coaxial cable and connector.

c. Accessory Kit.

- (1) There are no readily replaceable parts of the accessory kit.
- (2) The only item of the accessory kit that can readily be repaired is the RF cable assembly.
- (3) Radio Frequency Cable RG-8A/U and Radio Frequency Cable RG-59/U are similarly constructed and a connector can be replaced as outlined in *b(3)* above.
- (4) The antenna connector is a sealed weatherproof unit and should not be taken apart unless absolutely necessary. To open the unit, the old sealing compound should be removed completely and a suitable sealing compound should be used when reassembling the unit. A cross-sectional drawing of the unit is shown in figure 30.

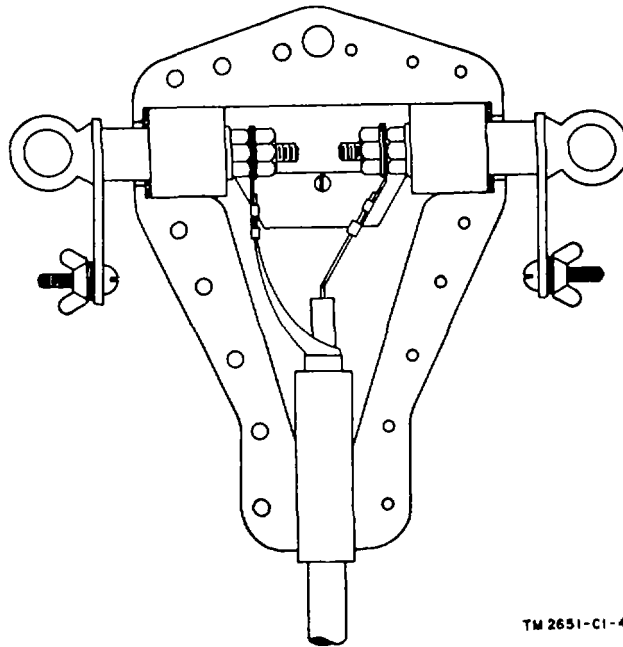

Figure 30. Cross section of antenna connector used in Antenna Group AN/GRA-12.

CHAPTER 4

THEORY

31. Circuit Theory

a. *General.* Five different types of antenna installation are available with Antenna Group AN/GRA-4: vertical, center-fed Hertz, off-center-fed Hertz, L-type, and slanting wire. With Antenna Group AN/GRA-12, the center-fed Hertz antenna is the only one normally constructed. The five types of antenna installation used are variations of the basic half-wave antenna and vary fundamentally only in the manner of installation and in the method of feeding the signal from the transmitter to the antenna or from the antenna to the receiver. The characteristics of transmitting and receiving antennas are similar, and therefore a good transmitting antenna will also function well for reception. Certain practical limitations on the use of the same antenna for both transmitting and receiving are explained below.

b. *Basic Half-Wave Antenna.* During transmission, a radio-frequency current in a conductor produces an electromagnetic field which is radiated. During receiving periods, an electromagnetic field which is cut by a conductor will cause a current flow in the conductor. If the length of the conductor wire is equal to half the wave length of the electromagnetic wave, the result is a half-wave antenna. In a half-wave antenna, current is always maximum at the center and minimum at the ends, while voltage is minimum at the center and maximum at the ends (fig. 31). Impedance is minimum at the center and maximum at the ends. The impedance at the center of a half-wave antenna is approximately 72 ohms, and the impedance at the ends is approximately 2,500 ohms. The current distribution in the antenna is always the same regardless of the amount of current flow, but the amplitude of the current at any point on the antenna varies directly with the amplitude of the signal voltage.

c. *Computing Antenna Length.* An antenna, when properly tuned, is a resonant circuit and acts the same as any other resonant circuit, such as the tank circuit in a radio receiver or transmitter. The wire used to make up the antenna has a certain amount of inductance per foot and a certain amount of distributed capacitance per foot. When the wire is

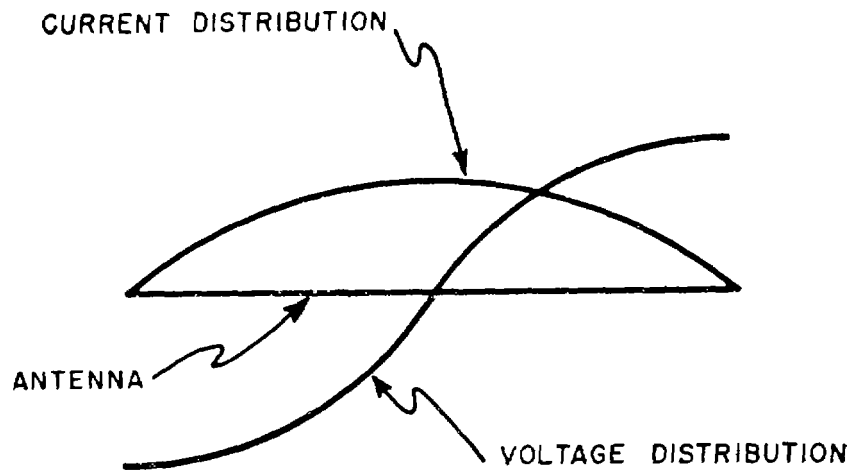

TM2651 - 26

Figure 31. Current and voltage distribution in a half-wave antenna.

placed above the ground, there is a small amount of capacitance between the wire and ground. When the inductive reactance of the wire is equal to the capacitive reactance of the wire, the antenna is resonant. Hence, a half-wave antenna, when cut to the correct length, presents a resistive load to the transmitter. The formula for determining the physical length of an antenna is—

$$\frac{300,000,000}{\text{Freq in cycles}} = \text{Length in meters, or for a half-wave antenna the formula becomes: } \frac{492}{\text{Freq in mc}} = \text{Length in feet}$$

The above formula gives the natural resonant frequency of a solid conductor in free space and assumes zero resistance in the conductor. The physical length of an antenna is affected by its height above ground and by the size and type of wire used for its construction. Table II is a half wave length chart. The lengths in the chart are correct when using Wire W-120 with a reel on either or both ends.

d. *Directive Patterns* (fig. 32).

- (1) *General.* Maximum radiation occurs at the center of a half-wave antenna, because the current is greatest at that point. Little radiation takes place at the ends because the current is minimum there. Ideally, the radiation is at right angles to the plane of the antenna wire

and completely encircles the conductor. The resulting antenna pattern, therefore, can be compared to a doughnut with the radiator passing through its center (A, fig. 32).

- (2) *Vertical half-wave antenna pattern.* The vertical half-wave antenna radiates equally in all directions in the horizontal plane. B shows the field pattern in the horizontal plane which results from a vertical half-wave antenna. The field pattern is a circle and the field strength is the same in any horizontal direction from the antenna wire. Although there is no vertical radiation along the direct line of the axis of the vertical half-wave, there are different amounts of radiation at different angles to the line of the antenna axis. C shows a cross section of the doughnut-shaped pattern. It is readily seen that along line OA, there is little radiation, while there is some radiation along line OB, and even more along line OC.
- (3) *Horizontal half-wave antenna pattern.* For a horizontal half-wave antenna, the doughnut-shaped pattern in A applies if rotated 90° . D shows half of the doughnut-shaped pattern for the horizontal half-wave antenna. As in the vertical antenna, maximum radiation occurs in a plane perpendicular to the center line of the antenna, and as the plane angle decreases from the perpendicular, the radiation also decreases. Thus, there is considerable radiation in planes other than the horizontal. This radiation travels upward, strikes the ionosphere, and bounces back; this results in propagation of the wave over considerable distances. This type of wave propagation is called *sky wave*. At high frequencies, the radiation is not reflected by the ionosphere since it pierces the ionosphere and continues into outer space. The relative length of the vectors illustrates the variation of the amount of radiation with the change in plane angle. The directive pattern of the horizontal half-wave antenna is bidirectional in the horizontal plane and the antenna should be oriented in the direction of maximum signal strength.

32. Antenna Circuits

a. Vertical Antenna.

- (1) The vertical antenna is a variation of the basic half-wave antenna. The mast represents a quarter wave length of the radio signal, and the other quarter wave

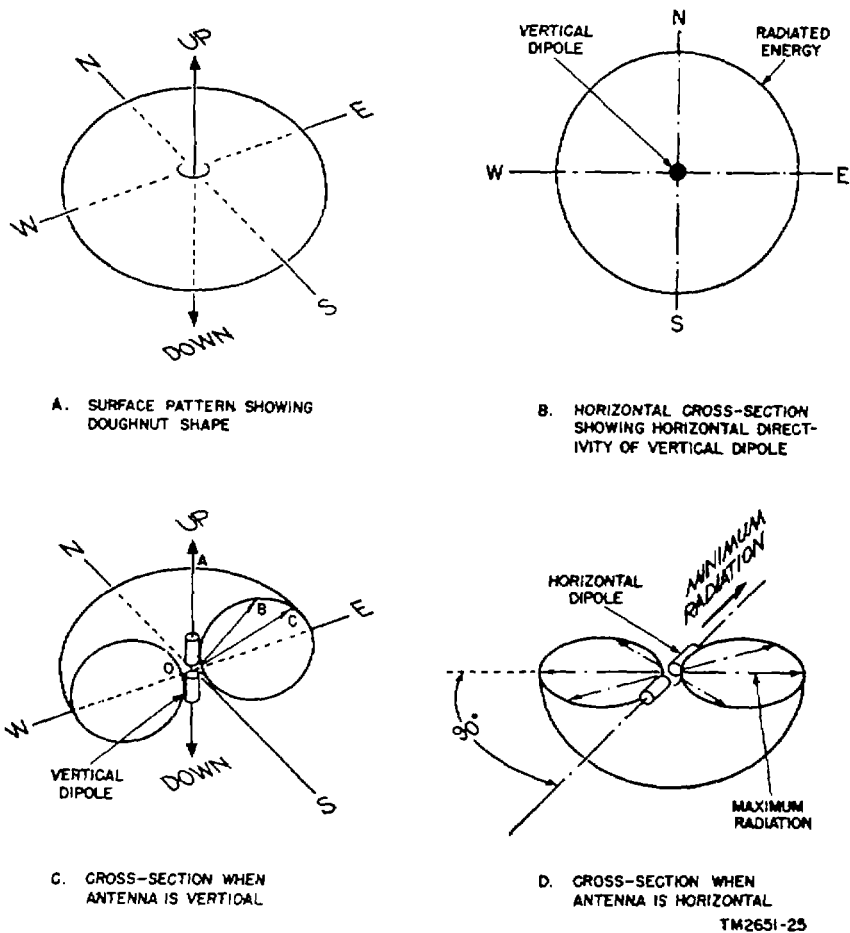

Figure 32. Radiation pattern of a half-wave antenna.

length is supplied by a ground *image* to make up the required half-wave antenna. The single-wire feed line is connected to the binding post at the base of the mast assembly, which is insulated from ground by Insulator MX-384/GRA-4. Good contact with ground is secured by the use of Counterpoise CP-12. This type antenna may be compared to a spring which, when vibrating at a given frequency, will continue to vibrate at that frequency, even if half of it is removed. In the case of the antenna, the missing half of the antenna is supplied by what can be regarded as the *image* of the radiating portion in ground. The distribution of current, voltage, and impedance in the radiator is the same as that of one-half of the

simple half-wave antenna. The grounded vertical antenna is advantageous at low frequencies, because it reduces the total physical length of the antenna required by one-half. At the low frequencies used, the physical length required for a full half-wave antenna becomes impractical. The physical length of the vertical grounded antenna may be more than a quarter wave length, but it must be an odd number of quarter wave lengths if resonance is to be obtained at the base where the feed line is connected. If the antenna is over a quarter wave length high, but less than a half wave length, the input at the base will be inductive, and will require the addition of capacitance in series with the feed to make the input resonant. The tuning unit is used for this purpose (par. 33).

- (2) The vertical grounded antenna uses the antenna mast assembly as the radiator. This antenna is suitable for both transmitting and receiving over short ranges (0 to 30 miles) at low frequencies of 1.7 mc to 2.0 mc. The radiation pattern of the vertical antenna is nondirectional in a horizontal plane and the signal travels close to the earth. Hence, this antenna is most efficient in fairly open terrain, because the radiation pattern might be distorted by large masses such as buildings, mountains, heavy foliage, and undergrowth which tend to absorb the signal.

b. Horizontal Antennas. In the jungle and other locations where vegetation is dense, the vertical antenna cannot be used, because all the ground wave is absorbed. This necessitates the use of a horizontal antenna and sky wave communication.

- (1) *Center-fed Hertz antenna.* The center-fed Hertz (doublet) antenna is always one-half wave length and is fed at the center by coaxial cable. This antenna can be used on all frequencies from 1.5 mc to 18.0 mc. It consists of two lengths of wire, each a quarter wave length at the operating frequency. The center-fed Hertz antenna is similar to the vertical antenna described in a above, except that the image supplied by the ground in the vertical antenna is replaced here by an actual physical quarter wave length of wire. The transmission line is a low-impedance coaxial cable which is connected to the low-impedance point at the center of the antenna. Current and voltage distribution is the same as that described for the simple half-wave antenna; current is maximum at the center and zero at the ends, and voltage

is maximum at the ends and minimum at the center. Because the antenna is independent of ground, it can be installed far above the surface of the earth. The center-fed Hertz antenna is the most efficient radiator and should be used whenever possible. It can be used to particular advantage if the station is concealed and a clearing is available for mounting the antenna at a maximum distance of 300 feet. The coaxial cable should leave the antenna at a 90° angle and should be kept short. The cable should be laid out as straight as possible and not piled up. When a length of coaxial cable is used on good-conducting ground, there is a loss of received signal caused by the reactance of the line, and this loss cannot be tuned out at the receiver. When transmitting, this reactance is eliminated by the tuning unit, as explained below. Therefore, if a long transmission line is used with the center-fed Hertz antenna, it is advantageous to use a separate receiving antenna.

- (2) *Off-center-fed Hertz antenna.* The off-center-fed Hertz antenna consists of a half wave length of wire fed by means of a single-wire feeder. This antenna may be used on all frequencies in the range of 1.5 mc to 11.0 mc. The distribution of current, voltage, and impedance is the same in this antenna as in the center-fed Hertz antenna. The impedance of a single-wire feeder is approximately 500 ohms, and the feeder is therefore, connected at a 500-ohm point on the antenna. The point at which the feeder is connected to the antenna can be found by multiplying the antenna length by .361; the resulting figure is the number of feet from one end of the antenna to the feeder. The directive pattern of the off-center-fed Hertz antenna is the same as that of the center-fed Hertz antenna.
- (3) *L-type antenna.* The L-type antenna is similar to the off-center-fed Hertz antenna. It consists of a half wave length of wire fed by means of a single-wire feeder. The distribution of current, voltage, and impedance is the same as in the half-wave antenna (par. 31). The feeder is connected at one end, a high-voltage, maximum-impedance point. For most efficient matching, therefore, the feeder should be one-quarter wave length, and should be exactly perpendicular. A feeder of one-quarter wave length shows a continuity of the standing wave current with that of the antenna and causes a minimum of radiation loss.

Any other length of feeder causes a mismatch and tends to set up a radiation field about the feeder which interferes with the desired radiation of the antenna. Since the supporting masts are 40 feet in height and the feeder must be one-quarter wave length, this antenna is most efficient at one frequency (5.6 mc); at all other frequencies, a compromise must be made. It is not advisable, however, to use the L-type antenna on frequencies higher than 5.8 mc. The directive pattern of this antenna, as in the other horizontal half-wave antenna, is bidirectional in the horizontal plane with maximum radiation in a line perpendicular to the center of the antenna.

- (4) *Slanting wire antenna.* The slanting wire antenna is an adaptation of the horizontal antenna. It is usually one-half wave length. and is fed at the lower end, connecting directly to the transmitter, receiver, or tuning unit at that point. The measurement of the antenna length should start at the transmitter, receiver, or tuning unit binding post. The slanting wire antenna is not suitable for use on frequencies below 4.5 mc when using a 40-foot mast, because the excessive sag which results with wire lengths over 100 feet tends to reduce the effective height of the antenna and lower its efficiency. Distribution of current, voltage, and impedance is the same in this antenna as in the other half-wave antennas. This antenna is highly directional; radiation takes place at right angles to the antenna wire, in a skyward direction.

33. Tuner TN-174/GRA-4

(fig. 33)

Although the theoretical length of a half-wave antenna can be computed exactly for any given frequency, the actual physical length of antenna which operates most satisfactorily for the same frequency may vary somewhat from this computed figure. Best operation is obtained when the impedance of the feeder line is matched perfectly to the impedance of the antenna and maximum current is present in the antenna standing wave. This condition is known as resonance. The discrepancy between the computed wave length and the optimum physical wave length is due to certain variable factors, such as the resistance of the antenna wire, the loading effects of interference from surrounding objects, etc. Since the optimum length of line cannot be computed readily, some means of tuning the line to resonance must be provided. This is accomplished by means of the tuner. The tuner consists of a 12 to 244-micromicrofarad ($\mu\mu\text{f}$) variable capacitor

housed in a metal box, with a neon lamp connected in parallel across it. The tuner is then connected in series with the antenna lead-in. Tuning the capacitor varies the amount of reactance in the line, making it possible to adjust for the resonant condition by actual experiment. Resonance is indicated by the neon lamp which glows at maximum brilliance when the line is in the resonant condition.

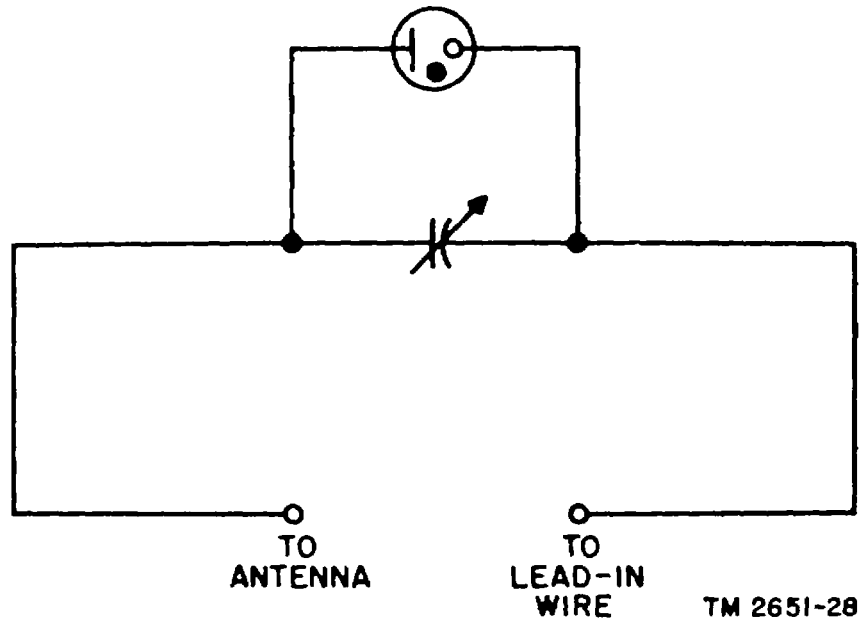

Figure 33. Tuner TN-174/GRA-4, schematic diagram.

CHAPTER 5
SHIPMENT, LIMITED STORAGE, AND DEMOLITION

Section I. SHIPMENT AND LIMITED STORAGE

34. Disassembly of Equipment

Warning. Shut all power off before performing any disassembly.

a. *Antennas.* To disassemble any of the various antennas, follow the instructions given below:

(1) *Slanting wire antenna.*

- (a) Disconnect the lead-in wire from the transmitter, receiver, or tuning unit.
- (b) Release the tied ends of the halyards and lower the antenna slowly; be careful not to damage the insulators.
- (c) Unfasten the antenna wire or wires, lead-in wire, and the reel from the insulator ends of the halyards.
- (d) Wind the antenna wire onto each reel; use one hand to hold the reel against the body and to guide the wire and the other hand to turn the handle.

Caution: Improper winding will result in kinks, which will render the wire useless.

- (e) Remove the pulley support for the upper halyard.
- (f) Remove the ground stake and wipe clean.
- (g) Coil and bind the halyards.

(2) *L-type antenna.* Follow the instructions in (1) (a) through (d) above, and then proceed as follows:

- (a) Tie the two ends of the mast halyard to prevent the free end from running through the pulley.
- (b) Remove the pulley support for the other halyard.
- (c) Coil and bind the halyard.

(3) *Off-center-fed Hertz antenna.* Follow the instructions in (1) (a) through (d) above, and then proceed as follows:

- (a) Remove and clean the ground stake.
- (b) Coil and bind the halyards.

(4) *Center-fed Hertz (doublet) antenna.*

- (a) Disconnect Cord CG-357/U or Rf Cable Assembly CG-692/U from the transmitter.
- (b) Release the tied ends of the halyards and lower the antenna slowly; be careful not to damage the insulators.
- (c) Unfasten the antenna wire terminations from the center insulator and unfasten the reels from the insulator ends of the halyards.
- (d) Wind the antenna wire onto each reel.
- (e) Unfasten the cable from the center insulator and coil the cable as follows:
 1. Make one coil and tie coil with friction tape.
 2. Using both hands, coil the remainder of the cable.

Note. With Antenna Group AN/GRA-12, the centering insulator (Connector CC-51) is part of the cable assembly and is coiled with the cable.

- (f) Tie the two ends of each halyard to prevent the free end from running through the pulley.

b. Mast. To lower and disassemble the mast, follow the instructions given below:

- (1) Disconnect and remove the counterpoise.
- (2) Remove all three guys from one stake located at a 90' angle to the pivot pin of the swivel stake.
- (3) Hold all three guys firmly and walk slowly toward the mast. As the antenna tilts, the pull on the guys will become stronger.
- (4) Brace yourself firmly while walking. Continue until the mast pole reaches the ground.
- (5) To disassemble the mast pole, reverse the assembly instructions given in paragraph 15.
- (6) Remove all stakes, including the swivel stake. Clean the stakes and plate.
- (7) Coil and bind the halyard, if used, and each guy.

35. Repacking for Shipment or Limited Storage

a. The exact procedure in repacking for shipment or limited storage depends on the material available and the conditions under which the equipment is to be shipped or stored. Refer to paragraph 14 and follow the instructions in reverse order.

b. Pack the components in corrugated cartons. Protect the components with a waterproof paper barrier. Seal the seams of the paper barrier with a waterproof sealing compound or tape. Pack the protected components in a wooden case.

Section II. DEMOLITION OF MATERIAL

36. Authority for Demolition

Demolition of the equipment will be accomplished only upon the order of the commander. The destruction procedures outlined in paragraph 37 will be used to prevent further use of the equipment.

37. Methods of Destruction

- a. *Smash.* Smash the tuning unit and insulators; use sledges, handaxes, pickaxes, hammers, crowbars, or heavy tools.
- b. *Cut.* Cut wires, halyards, guys, bag, counterpoise; use axes, handaxes, or machetes.
- c. *Burn.* Burn cords, halyards, guys, and technical manuals; use gasoline, kerosene, oil, flame throwers, or incendiary grenades.
- d. *Bend.* Bend mast sections, stakes, whip adapter, carrying device, reels, and measuring tape.
- e. *Explode.* If explosives are necessary, use firearms, grenades, or TNT.
- f. *Dispose.* Bury or scatter the destroyed parts in slit trenches, foxholes or other holes, or throw them into streams.

By Order of *Wilber M. Brucker*, Secretary of the Army:

MAXWELL D. TAYLOR,
General, United States Army,
Chief of Staff.

Official:

JOHN A. KLEIN,
Major General, United States Army,
The Adjutant General.

Distribution:

Active Army:

CNGB (1)	US Army Tng Cen (2)
ASA (3)	POE (OS) (2)
Tec Svc, DA (1) except	Trans Terminal Comd (2)
CSIGO (30)	Army Terminals (2)
Tec Svc Bd (1)	OS Sup Agencies (2)
Hq CONARC (5)	Army Elct PG (1)
CONARC Bd (Incl ea Test	Sig Fld Maint Shops (3)
Sec) (1)	Sig lab (5)
Army AA Comd (2)	ACS (3)
OS Maj Comd (5)	Mil Dist (1)
OS Base Comd (5)	Units org under fol TOE:
Log Comd (5)	11-7C, Sig Co, Inf Div (2)
MDW (1)	11-16C, Hq&HqCo, Sig Bn, Corps
Armies (5)	or Abn Corps (2)
Corps (2)	11-57C, Armd Sig Co (2)
Ft & Cp (2)	11-127R, Sig Rep Co (2)
Sp Wpn Comd (2)	11-128C, Sig Depot Co (2)
Army Cml Cen (4)	11-500R, Sig Svc Org (2)
Gen & Br Svc Sch (5)	11-557C, Abn Sig Co (2)
except Sig Sch (25)	11-587R, Sig Base Maint Co (2)
Gen Depots (2) except	11-592R, Hq&Hq Co, Sig Base
Atlanta Gen Depot	Depot (2)
(None)	11-597R, Sig Base Depot Co (2)
Sig Sec. Gen Depots (10)	
Sig Depots (17)	

NG: State AG (6); units---same as Active Army except allowance is one copy to each unit.

USAR: None.

For explanation of abbreviations used, see SR 320-50-1.

RECOMMENDED CHANGES TO EQUIPMENT TECHNICAL PUBLICATIONS

 <div style="border: 1px solid black; border-radius: 15px; padding: 5px; display: inline-block; margin-left: 20px;"> <p style="font-size: small; margin: 0;">THEN...JOT DOWN THE DOPE ABOUT IT ON THIS FORM. CAREFULLY TEAR IT OUT, FOLD IT AND DROP IT IN THE MAIL.</p> </div>				<h2 style="margin: 0;">SOMETHING WRONG WITH PUBLICATION</h2>	
FROM: (PRINT YOUR UNIT'S COMPLETE ADDRESS)					
DATE SENT					
PUBLICATION NUMBER		PUBLICATION DATE	PUBLICATION TITLE		
BE EXACT PIN-POINT WHERE IT IS					
PAGE NO.	PARA-GRAPH	FIGURE NO.	TABLE NO.	IN THIS SPACE, TELL WHAT IS WRONG AND WHAT SHOULD BE DONE ABOUT IT.	
PRINTED NAME, GRADE OR TITLE AND TELEPHONE NUMBER			SIGN HERE		

The Metric System and Equivalents

Linear Measure

1 centimeter = 10 millimeters = .39 inch
 1 decimeter = 10 centimeters = 3.94 inches
 1 meter = 10 decimeters = 39.37 inches
 1 dekameter = 10 meters = 32.8 feet
 1 hectometer = 10 dekameters = 328.08 feet
 1 kilometer = 10 hectometers = 3,280.8 feet

Weights

1 centigram = 10 milligrams = .15 grain
 1 decigram = 10 centigrams = 1.54 grains
 1 gram = 10 decigrams = .035 ounce
 1 decagram = 10 grams = .35 ounce
 1 hectogram = 10 decagrams = 3.52 ounces
 1 kilogram = 10 hectograms = 2.2 pounds
 1 quintal = 100 kilograms = 220.46 pounds
 1 metric ton = 10 quintals = 1.1 short tons

Liquid Measure

1 centiliter = 10 milliliters = .34 fl. ounce
 1 deciliter = 10 centiliters = 3.38 fl. ounces
 1 liter = 10 deciliters = 33.81 fl. ounces
 1 dekaliter = 10 liters = 2.64 gallons
 1 hectoliter = 10 dekaliters = 26.42 gallons
 1 kiloliter = 10 hectoliters = 264.18 gallons

Square Measure

1 sq. centimeter = 100 sq. millimeters = .155 sq. inch
 1 sq. decimeter = 100 sq. centimeters = 15.5 sq. inches
 1 sq. meter (centare) = 100 sq. decimeters = 10.76 sq. feet
 1 sq. dekameter (are) = 100 sq. meters = 1,076.4 sq. feet
 1 sq. hectometer (hectare) = 100 sq. dekameters = 2.47 acres
 1 sq. kilometer = 100 sq. hectometers = .386 sq. mile

Cubic Measure

1 cu. centimeter = 1000 cu. millimeters = .06 cu. inch
 1 cu. decimeter = 1000 cu. centimeters = 61.02 cu. inches
 1 cu. meter = 1000 cu. decimeters = 35.31 cu. feet

Approximate Conversion Factors

<i>To change</i>	<i>To</i>	<i>Multiply by</i>	<i>To change</i>	<i>To</i>	<i>Multiply by</i>
inches	centimeters	2.540	ounce-inches	Newton-meters	.007062
feet	meters	.305	centimeters	inches	.394
yards	meters	.914	meters	feet	3.280
miles	kilometers	1.609	meters	yards	1.094
square inches	square centimeters	6.451	kilometers	miles	.621
square feet	square meters	.093	square centimeters	square inches	.155
square yards	square meters	.836	square meters	square feet	10.764
square miles	square kilometers	2.590	square meters	square yards	1.196
acres	square hectometers	.405	square kilometers	square miles	.386
cubic feet	cubic meters	.028	square hectometers	acres	2.471
cubic yards	cubic meters	.765	cubic meters	cubic feet	35.315
fluid ounces	milliliters	29.573	cubic meters	cubic yards	1.308
pints	liters	.473	milliliters	fluid ounces	.034
quarts	liters	.946	liters	pints	2.113
gallons	liters	3.785	liters	quarts	1.057
ounces	grams	28.349	liters	gallons	.264
pounds	kilograms	.454	grams	ounces	.035
short tons	metric tons	.907	kilograms	pounds	2.205
pound-feet	Newton-meters	1.356	metric tons	short tons	1.102
pound-inches	Newton-meters	.11296			

Temperature (Exact)

°F	Fahrenheit temperature	5/9 (after subtracting 32)	Celsius temperature	°C
----	---------------------------	-------------------------------	------------------------	----

