



HARRIS

RF COMMUNICATIONS

RF-3200T
HF-SSB
COMMUNICATIONS SYSTEM
USERS GUIDE



**LIMITED ONE YEAR WARRANTY
HARRIS CORPORATION (RF COMMUNICATIONS GROUP)**

FROM HARRIS TO YOU – This warranty is extended to the original buyer and applies to all Harris Corporation, RF Communications Group equipment purchased and employed for the service normally intended, except those products specifically excluded.

WHAT WE WILL DO – If your Harris Corporation, RF Communications Group equipment purchased from us for use outside the United States fails in normal use because of a defect in workmanship or materials within one year from the date of shipment, we will repair or replace (at our option) the equipment or part without charge to you, at our factory. If the product was purchased for use in the United States, we will repair or replace (at our option) the equipment or part without charge to you at our Authorized Repair Center or factory.

WHAT YOU MUST DO – You must notify us promptly of a defect within one year from date of shipment. Assuming that Harris concurs that the complaint is valid, and is unable to correct the problem without having the equipment shipped to Harris:

- Customers with equipment purchased for use outside the United States will be supplied with information for the return of the defective equipment or part to our factory in Rochester, NY, U.S.A., for repair or replacement. You must prepay all transportation, insurance, duty and customs charges. We will pay for return to you of the repaired/replaced equipment or part, C.I.F. destination; you must pay any duty, taxes or customs charges.
- Customers with equipment purchased for use in the United States must obtain a Return Authorization Number, properly pack, insure, prepay the shipping charges and ship the defective equipment or part to our factory or to the Authorized Warranty Repair Center indicated by us.

Harris Corporation
RF Communications Group
Customer Service
1680 University Avenue
Rochester, NY 14610, U.S.A.

Telephone: (716) 244-5830
Telex: 240313
Cable: RFCOM

Harris will repair or replace the defective equipment or part and pay for its return to you, provided the repair or replacement is due to a cause covered by this warranty.

WHAT IS NOT COVERED – We regret that we cannot be responsible for:

- Defects or failures caused by buyer or user abuse or misuse.
- Defects or failures caused by unauthorized attempts to repair or alter the equipment in any way.
- Consequential damages incurred by a buyer or user from any cause whatsoever, including, but not limited to transportation, non-Harris repair or service costs, downtime costs, costs for substituting equipment or loss of anticipated profits or revenue.
- The performance of the equipment when used in combination with equipment not purchased from Harris.
- **HARRIS MAKES NO OTHER WARRANTIES BEYOND THE EXPRESS WARRANTY AS CONTAINED HEREIN. ALL EXPRESS OR IMPLIED WARRANTIES OF FITNESS FOR A PARTICULAR PURPOSE OR MERCHANTABILITY ARE EXCLUDED.**

SERVICE WARRANTY – Any repair service performed by Harris under this limited warranty is warranted to be free from defects in material or workmanship for sixty days from date of repair. All terms and exclusions of this limited warranty apply to the service warranty.

IMPORTANT – Customers who purchased equipment for use in the United States must obtain a Return Authorization Number before shipping the defective equipment to us. Failure to obtain a Return Authorization Number before shipment may result in a delay in the repair/replacement and return of your equipment.

IF YOU HAVE ANY QUESTIONS – Concerning this warranty or equipment sales or services, please contact our Customer Service Department.

RF-3200T

HF-SSB

COMMUNICATIONS SYSTEM

USERS GUIDE

Copyright © 1988
By Harris Corporation
All Rights Reserved



Equipment manufactured by Harris Corporation, RF Communications Group meets stringent quality and safety standards. However, high voltages are present in many radio products, and only a skilled technician should attempt to remove outer covers and make adjustments or repairs. All personnel who operate and maintain the equipment should be familiar with this page as a safety preparedness measure. Although this procedure is reproduced as a service to the personnel involved with this equipment, Harris Corporation assumes no liability regarding any injuries incurred during the operation and repair of such equipment, or the administration of this suggested procedure.

ELECTRICAL SHOCK: EMERGENCY PROCEDURE

The victim will appear unconscious and may not be breathing. If the victim is still in contact with the voltage source, disconnect the power source in a manner safe to you, or remove the victim from the source with an insulated aid (wooden pole or rope). Next, determine if the victim is breathing and has a pulse. If there is a pulse but no breathing, administer artificial respiration. If there is no pulse and no breathing, perform CPR (if you have been trained to do so). If you have not been trained to perform CPR, administer artificial respiration anyway. Never give fluids to an unconscious person.

WHEN BREATHING STOPS

FIRST, send someone to get a **DOCTOR**.
THEN, administer first aid to restore breathing (artificial respiration):

1 IF A VICTIM APPEARS TO BE UNCONSCIOUS
 TAP VICTIM ON THE SHOULDER AND SHOUT, "ARE YOU OKAY?"



2 IF THERE IS NO RESPONSE
 TILT THE VICTIM'S HEAD, CHIN POINTING UP. Place one hand under the victim's neck and gently lift. At the same time, push with the other hand on the victim's forehead. This will move the tongue away from the back of the throat to open the airway.
IMMEDIATELY LOOK, LISTEN, AND FEEL FOR AIR.
 While maintaining the backward head tilt position, place your cheek and ear close to the victim's mouth and nose. Look for the chest to rise and fall while you listen and feel for the return of air. Check for about five seconds.

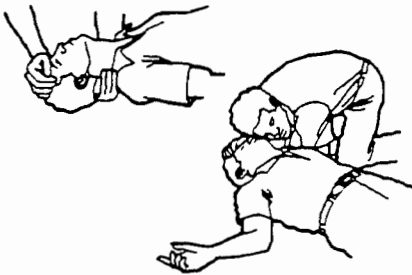

3 IF THE VICTIM IS NOT BREATHING
GIVE FOUR QUICK BREATHS.
 Maintain the backward head tilt, pinch the victim's nose with the hand that is on the victim's forehead to prevent leakage of air, open your mouth wide, take a deep breath, seal your mouth around the victim's mouth, and blow into the victim's mouth with four quick but full breaths just as fast as you can. When blowing, use only enough time between breaths to lift your head slightly for better inhalation.
 If you do not get an air exchange when you blow, it may help to reposition the head and try again.
AGAIN. LOOK, LISTEN, AND FEEL FOR AIR EXCHANGE.

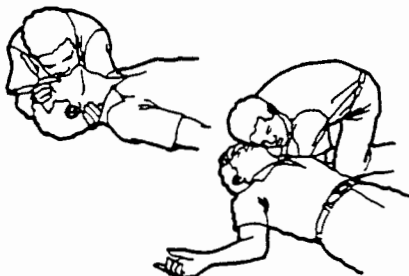

4 IF THERE IS STILL NO BREATHING
CHANGE RATE TO ONE BREATH EVERY FIVE SECONDS.



For more information about these and other life-saving techniques contact your Red Cross chapter for training
 "When Breathing Stops" reproduced with permission from an American Red Cross Poster

TABLE OF CONTENTS

Paragraph		Page
	Specifications	iv
1.	General Description	1
2.	Accessories	1
3.	Power	3
3.1	Dc Operation	3
3.2	Ac Operation	3
4.	Antenna Deployment	4
4.1	Center-Fed Antennas (Dipoles)	4
4.1.1	Deployment of Dipole Antennas	5
4.2	End-Fed Antenna (Whips and Longwires)	8
4.2.1	Deployment of End-Fed Antennas	8
4.3	Broadband Antennas	9

APPENDIX

LIST OF FIGURES

Figure		Page
Frontispiece	RF-3200T HF-SSB Communications System	
1	RF-3200T Accessories	2
2	Half-Wavelength Dipole Antenna	5
3	Slant-Wire Doublet	6
4	Inverted V Doublet	6
5	Dipole Deployment of the RF-3200T Antenna System	7
6	Long-Wire Deployment of the RF-3200T Antenna System	8
7	Longwire with Counterpoise Deployment of RF-3200T Antenna System	9

LIST OF TABLES

Table		Page
1	Accessories included with RF-3200T	1

SPECIFICATIONS

GENERAL

Frequency Range:	1.6 to 30 MHz transmit, 0.5 to 30 MHz receive, 10-Hz steps.
Number of Channels:	320 simplex or half-duplex.
Frequency/Channel Control:	Frequency or channel selection is microprocessor controlled, through either keypad entry, or with a simple, convenient tuning knob.
Channel Programming:	Front-panel programmable. Protection against unauthorized frequency change is provided by Security Access Code (std.) and removal of internal coding device.
Automatic Channel Scan:	9 user programmable groups.
Frequency Stability:	$\pm 0.00005\%$; ± 15 Hz maximum.
Operation Modes:	A3J (USB/LSB), A3A (SSB reduced carrier), A3H (compatible AM), A1 (CW), F1 (FSK/TTY - limited-duty cycle, external power supply provides full duty cycle operation).
Antenna Matching:	Digital coupler automatically matches transceiver output to a wide variety of whip, dipole, and long-wire antennas over a 1.6 to 30 MHz frequency range.
Power Input:	13.6 Vdc $\pm 20\%$, voice duty 10 A Average; 25 A peak; 115/230 Vac $\pm 15\%$, 50/60 Hz.
Meter:	Front panel: TX (watts), reflected power (watts), RX ("S" units).
Size:	8.5H x 21W x 14D in. (20.3H x 53.3W x 35.6D cm).
Weight:	47 lbs. (21.3 kg) w/accessories
TRANSMITTER	
Power Output:	SSB (U/L sideband): 125 watt PEP; AM compatible (H3E) 35 watts carrier.
Overload Protection:	PA fully protected from mismatch including open or shorted antenna and thermal overload
Carrier Suppression:	55 dB below PEP.
Intermodulation Distortion:	32 dB below PEP.

SPECIFICATIONS (Cont.)

TRANSMITTER (Cont.)

Undesired Sideband Suppression:	55 dB at 1 kHz.
Harmonic Suppression:	65 dB below PEP.
Spurious Suppression:	65 dB below PEP.
Audio Input:	Dynamic microphone. 600 ohm auxiliary input.
Residual Noise Level:	50 dB below PEP.
Audio Bandwidth:	2.4 kHz (standard), others optionally available.
Speech Processing:	Automatic level control with companded voice processing.

RECEIVER

Sensitivity:	SSB: 0.5 μ V for 10 dB SINAD; AM: 3 μ V for 10 dB SINAD.
Audio Output:	5 watts with less than 5% distortion. 600 ohm auxiliary output.
AGC Characteristics:	Audio output varies less than 2 dB for signals 10 μ V to 1 volt. Automatically selected dual time-constant AGC for voice or FSK/CW operation (standard).
Selectivity:	SSB: 300 to 2700 Hz at 6 dB (standard). Others optionally available.
Image Rejection:	-70 dB.
IF Rejection:	-80 dB.
Intermodulation Distortion:	-80 dB.
Desensitization:	-100 dB (100 kHz separation).
Spurious Response:	-70 dB.
Squelch:	Syllabic, voice controlled, with noise immunity.
Clarifier:	Digital \pm 250 Hz (10 Hz steps).
Overload Protection:	30 Vrms.
Noise Blanker:	Impulse noise protection (optional).

SPECIFICATIONS (Cont.)

ANTENNA COUPLER	
Frequency Range:	1.6 to 30 MHz
Tuning Capability:	1.6 to 30 MHz: long-wire, dipole, and 24 to 35 foot whip antennas. 2.0 to 30 MHz: 16 foot whip antennas. 4.0 to 30 MHz: 9 foot whip antennas.
RF Input Power:	125 watts PEP voice duty (30 watts average).
Input Impedance:	50 ohms.
Tuning Accuracy:	Less than 1.2:1 typical, 1.5:1 maximum.
Tuning Mode:	Fully automatic.
Tuning Time:	30 msec tune from memory, 1 second typical in learn mode.
Tune Memory:	320 channels, half-duplex or simplex. 16 random tune channels.
RF Tune Power:	10 to 20 watts forward throughout tune cycle.
Diagnostics/Protection:	Automatic cutback or bypass; over-temperature, over-voltage, excessive VSWR.
Coupler Control:	All control and dc power is multiplexed on the coaxial cable.
Remote Capability:	Up to 150 foot separation between transceiver and coupler with RG-213/U coaxial cable. Optional bias tee permits extended range using dc power cable.
Enclosure:	Splash-proof, high-temperature, ABS enclosure for exposed installations.
Primary Power Requirements:	13.6 Vdc \pm 20%, 1.3 A, typical. Power supplied by RF-3200 Transceiver.
Connections:	Input (Transceiver): Type N (watertight), surge protection. Output (Antenna): Ceramic, high-voltage insulator, surge protection. Ground: ground lug.
ENVIRONMENTAL	
Temperature:	-30°C to +60°C.
Shock, Vibration:	MIL-STD-810D.
Humidity:	MIL-STD-810D.

RF-3200T
HF-SSB
COMMUNICATIONS SYSTEM
USERS GUIDE

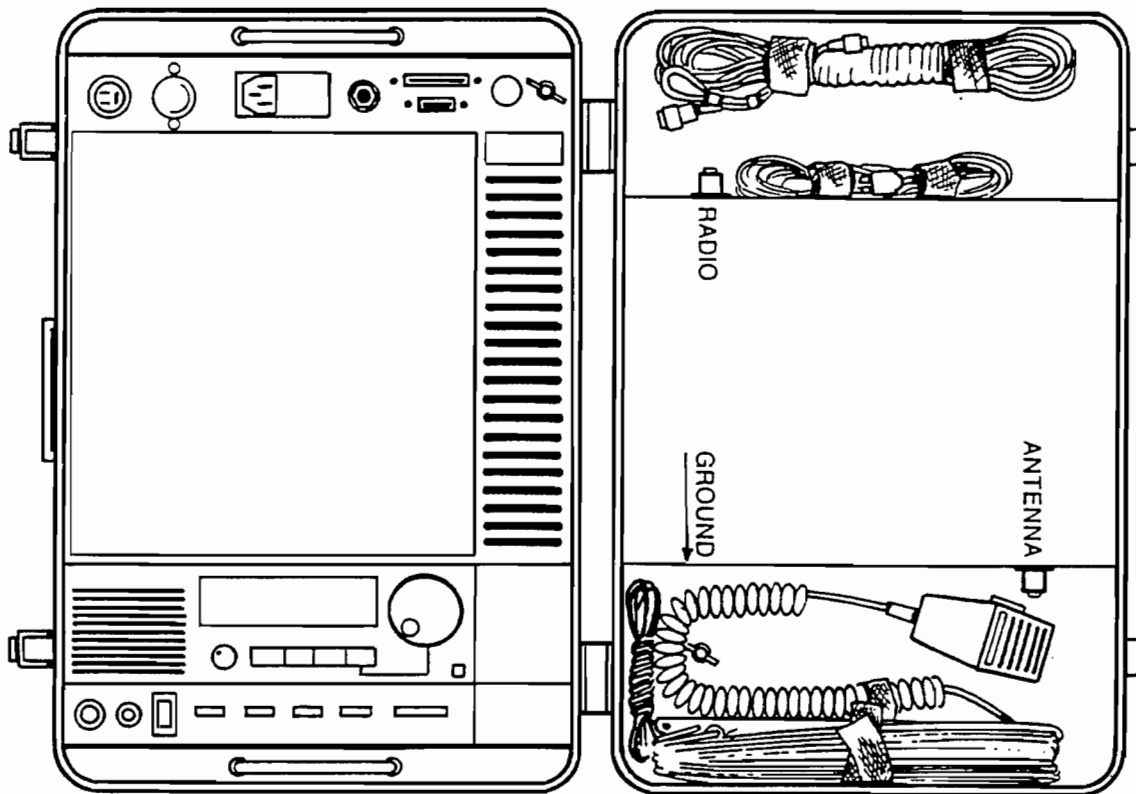
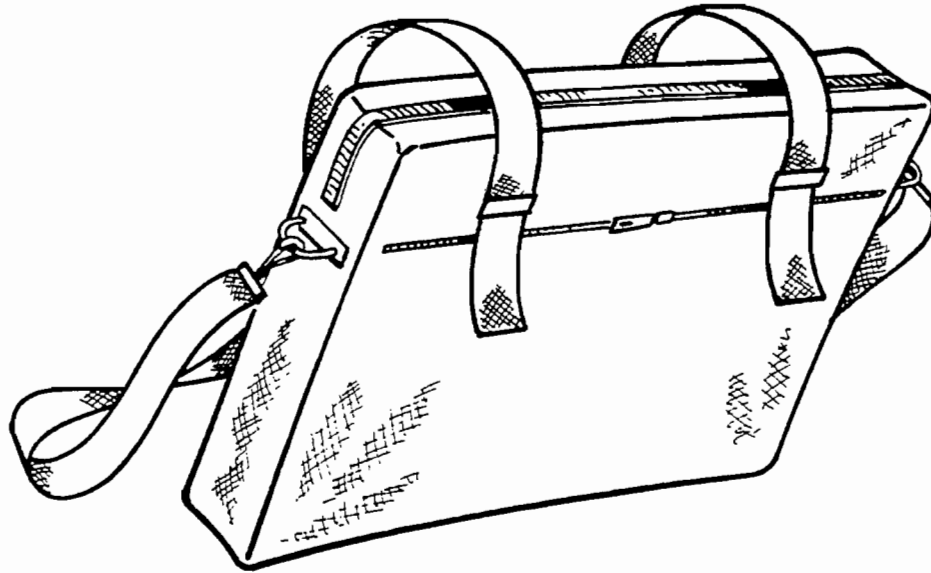

3200T-001

RF-3200T HF-SSB
COMMUNICATIONS SYSTEM

1. GENERAL DESCRIPTION

This manual describes the operation of the RF-3200T HF-SSB Communications System. The RF-3200T is a completely integrated, transportable system comprised of a 125-W HF-SSB transceiver, power supply, voice-duty digital antenna coupler, long-wire antennas, and accessories. As shown in the frontispiece, the RF-3200T consists of a transport case and an accessory bag.

2. ACCESSORIES

Table 1 contains a list of the accessories included with the RF-3200T Transportable HF Communications System.

Table 1. Accessories included with RF-3200T

Item No.	Qty.	Part Number	Description
1	1	W-0023	Line Cord, 6 ft.
2	1	Z52-0003-000	Adaptor kit, power
3	1	J-0060	3-to-2 Prong Ac Adaptor*
4	1	10262-0600	Power Cable, Aux dc*
5	1	p/o 10262-0700	Cable, Coax, BNC-to-UHF, 30 feet
6	2	p/o 10262-0700	Antenna, Long-Wire**
7	1	p/o 10262-0700	Adaptor, Dipole Antenna*
8	2	F-0016	Fuse, 6.0 A, QA, 250 V, 3AG*
9	4	F-0013	Fuse, 3.0 A, QA, 250 V, 3AG*
10	2	F-0105	Fuse, 30 A, QA, 32 V, 5AG*
11	2	F-0017	Fuse, 8.0 A, QA, 125 V, 3AG*
12	2	F15-0001-010	Fuse, 2.5 A, QA, 125 V, PIC*
13	1	SK-0423	Screwdriver, Flat Blade*
14	1	10262-0650	Cable Assy, Ground Strap
15	1	10212-0200	Microphone, Handheld
16	1	10262-6220	Case, Carry
17	1	J-0002	Connector, UHF Cable Plug M*
18	1	J22-0070-115	D Plug, 15-Position Connector*
19	1	J22-0070-514	Met Plastic Hood, 15 Position*
20	1	UG-21D/U	Connector, Coax, Type N*
21	1	10212-0050	RF-3200 User's Guide
22	1	10212-0051	RF-3200 Operator's Card
23	1	UG-201A/U	BNC-to-N Adaptor

* In accessory bag

** One in accessory bag

See figure 1 to identify the accessories included with the RF-3200T.

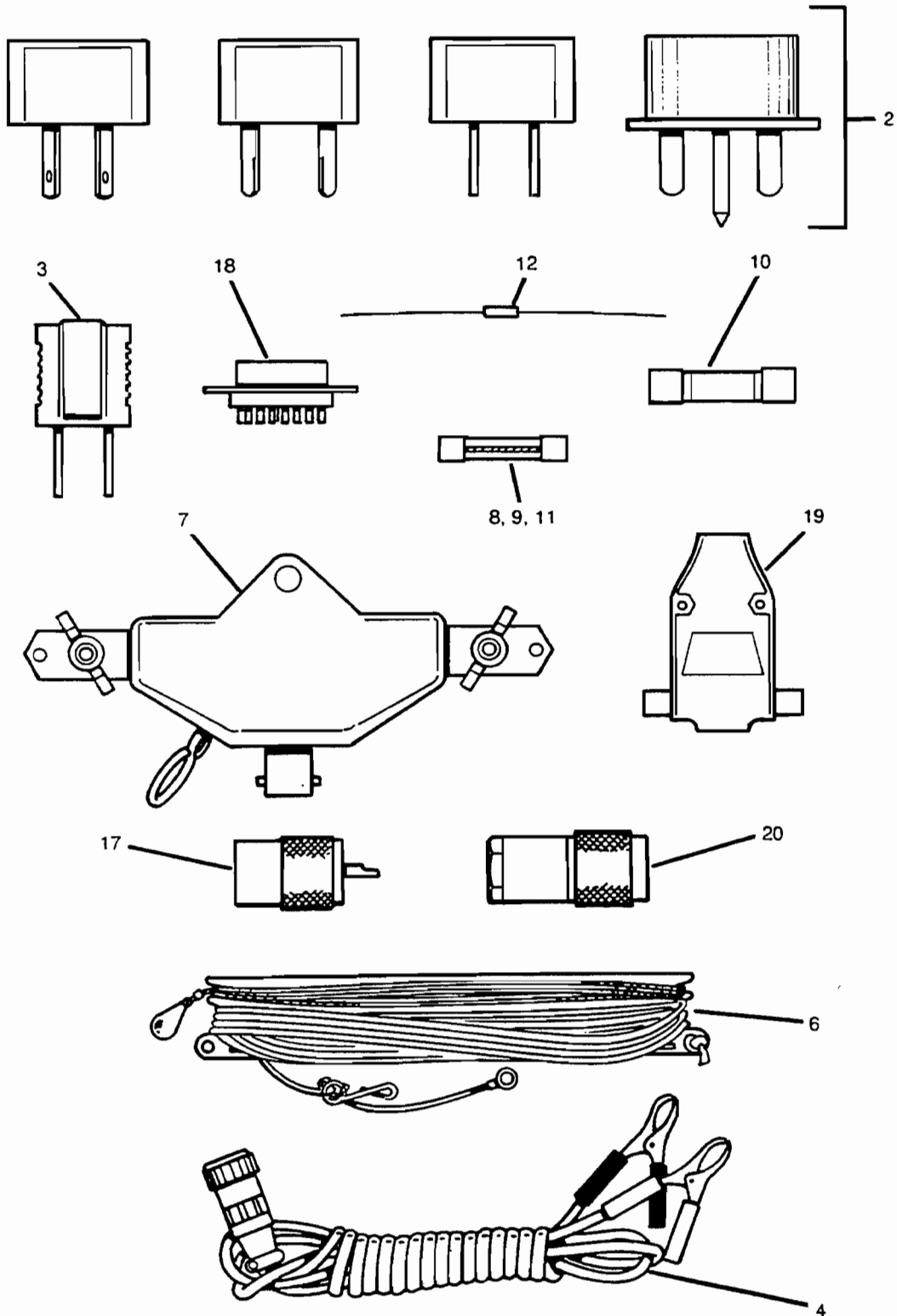

3200T-002

Figure 1. RF-3200T Accessories

3. POWER

The RF-3200T is capable of operation from both ac and dc power sources.

3.1 Dc Operation

Dc operation requires a battery or regulated power supply of $13.6 \pm 20\%$ Vdc capable of delivering 25 A peak. A 30-A fuse should be installed in the dc fuseholder. The average current consumption is 10 A for voice-duty operation

CAUTION

Use a power source that will not exceed 16 Vdc. The RF-3200T overvoltage protection will blow the 30-A fuse if this level is exceeded.

3.2 Ac Operation

Either a $115 \pm 15\%$ Vac or $230 \pm 15\%$ Vac power source may be used for ac operation. The housing lid of the ac power connector must be lifted (use the flat-blade screwdriver provided) to change the voltage selector wheel and fuse.

CAUTION

Select the proper voltage using the selector wheel and install the proper fuse (6 A for 115-V operation, 3 A for 230-V operation).

CAUTION

When operating the RF-3200T from a generator, the power switch must be in the OFF position during generator start up. Many generators are unregulated and may exceed normal line voltages during the start-up period.

The RF-3200 Transceiver and the internal ac power supply are thermally protected. Both will gradually cut back the output power of the transceiver if internal temperatures approach the maximum stress levels for components. Operation at reduced power levels will not damage either the RF-3200 or internal power supply. Normal voice-duty operation should not cause power cutback, but operation at greater than voice duty and at elevated ambient temperatures may result in reduced power output. In addition, the RF-3200T internal ac power supply is equipped with a failsafe temperature shutdown. If the gradual cutback does not reduce the internal temperature of the ac power supply sufficiently, the power supply will shut down. The front panel power switch must be turned off for at least 5 minutes to restore power. A failsafe power shutdown indicates a failure in the protection circuitry. If this type of shut down occurs, the unit may still be used but should be serviced as soon as possible.

4. ANTENNA DEPLOYMENT

WARNING

Care should be taken to deploy the antenna away from electrical wires, electrical machinery, or other potential sources of electrical shock. Antennas should not be deployed in areas where people or animals may contact them. **ALWAYS USE EXTREME CARE WHEN DEPLOYING ANTENNAS!**

Refer to the RF-3200 HF-SSB Transceiver User's Guide, Section 6-4, Propagation and Antenna Considerations. References for more specific information on HF propagation and antenna considerations are listed in Appendix A. Since HF propagation is dependent upon time of day, weather conditions, time of the year, and sun spot activity, this data is published periodically by radio amateur magazines. In general, higher frequencies are not useable during daylight hours and periods of sunspot activity.

The most critical factors in determining the performance of an HF communications system, such as the RF-3200T, are the deployment of the antenna and the effectiveness of the ground system. Since the RF-3200T is designed for quick deployment in emergency, disaster, and other portable applications, a well-designed and planned antenna site will seldom be possible. However, use of the guidelines in this manual will allow the user to set up the best antenna system for the given circumstances, and provide the user with a possible communications range of up to several thousand miles.

The RF-3200T HF-SSB Communications System can operate effectively using many different antenna configurations. Three common types of antenna systems include: resonant, center-fed dipoles; end-fed antennas such as whips and long wires; and broadband antennas such as log periodics (directional) and broadband dipoles. The RF-3200 Transceiver is designed to operate without an antenna coupler into a 50-ohm antenna system with all three types of antennas mentioned above; provided they present a VSWR of less than 2:1 at the operating frequency. At VSWRs greater than 2:1 the RF-3200 Transceiver will operate at a reduced power level determined by the Automatic Level Control circuitry. If a 50-ohm antenna is not available, an automatic antenna coupler is provided for matching purposes. This antenna coupler will tune most antenna configurations in 1 second.

In addition to safety considerations, the location of all antenna systems should be chosen to be clear of obstructions and electromagnetic noise sources such as high-tension lines or electrical machinery. The optional noise blanker will provide noise reduction in situations where deployment near noise sources is unavoidable.

4.1 Center-Fed Antennas (Dipoles)

The center-fed, resonant dipole or half-wavelength dipole is probably the most effective antenna system for HF communications. This antenna configuration consists of two one-quarter wavelength antenna legs which are center fed with 50-ohm coaxial cable. For best performance the 50-ohm coaxial feed should run perpendicular to each antenna leg. The length of each leg of the dipole antenna is determined by the following formula:

$$L = \lambda/4 = 234/\text{Frequency (MHz) feet}$$

or

$$L = \lambda/4 = 71.3/\text{Frequency (MHz) meters}$$

Where λ = one wavelength.

For example, for an operating frequency of 22.365 MHz, the length of each leg of the resonant dipole is:

$$L = \lambda/4 = 234/22.365 = 10.5 \text{ feet}$$

or

$$L = \lambda/4 = 71.3/22.365 = 3.2 \text{ meters}$$

4.1.1 Deployment of Dipole Antennas

The half-wave dipole can be deployed in several ways. The most common is shown in figure 2. Note that for a half-wavelength dipole, maximum radiation occurs at right angles (perpendicular) to the length of the antenna. Minimum radiation occurs at the ends of the antenna. The height (H) at which the dipole should be deployed is determined by practical limitations and the particular application. Half-wave dipoles have a more vertical radiation pattern the closer they are to ground plane. Conversely, they have an increasingly horizontal radiation pattern when H is increased. As a rule of thumb, a dipole one-quarter wavelength above the ground will have a nearly vertical radiation pattern, and a dipole one-half wavelength above the ground will have a 30 degree radiation pattern relative to the horizontal ground plane. At lower frequencies it may be difficult to deploy the antenna at these heights.

For example:

$$L = \lambda/4 = 234/1.6 = 146.25 \text{ feet.}$$

In these cases the antenna should be deployed as high as possible.

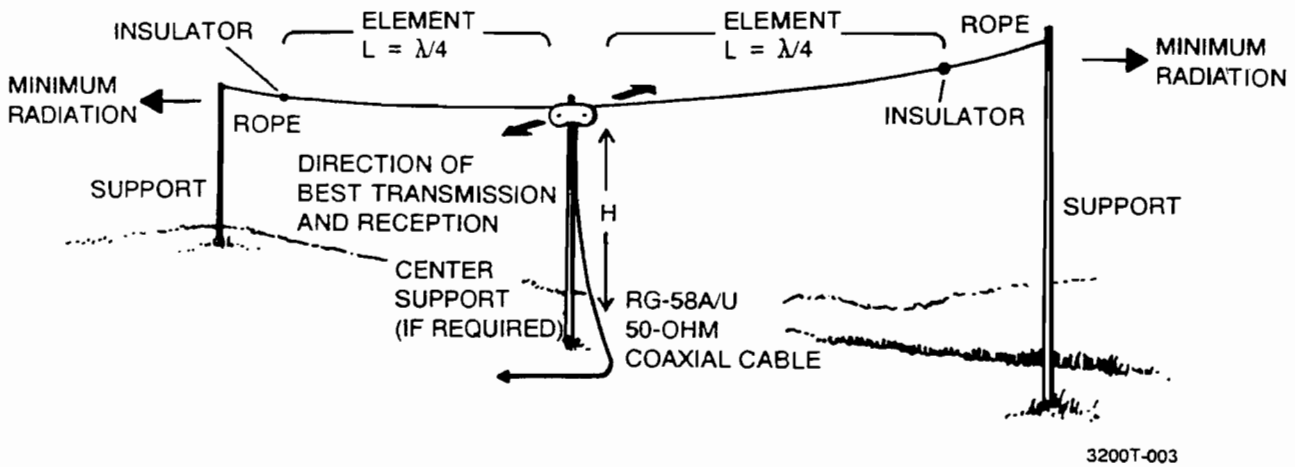
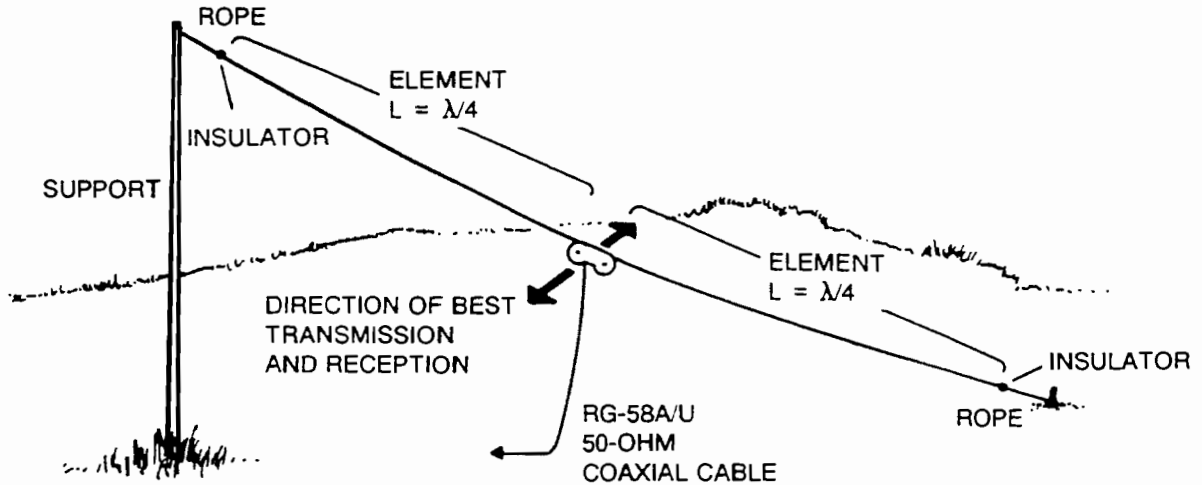

Figure 2. Half-Wavelength Dipole Antenna

As a general rule, position the dipole perpendicular to the direction of desired communications. For short-distance communications, the dipole should be placed approximately one-quarter wavelength above the ground for long-distance communications, the dipole should be placed approximately one-half wavelength above the ground.

When only a single upright support is available, two variations of the dipole may be utilized, as shown in figures 3 and 4. The configuration shown in figure 3 has a fairly low radiation angle and has maximum radiation directivity as shown.

The configuration shown in figure 4 is commonly referred to as the inverted V. The inverted V has the advantage of being nondirectional, exhibiting a nearly omnidirectional radiation pattern. The center-feed point should, whenever possible, be at least one-quarter wavelength above the ground and the angle between the two legs should be 90 to 120 degrees.



3200T-005

Figure 3. Slant-Wire Doublet

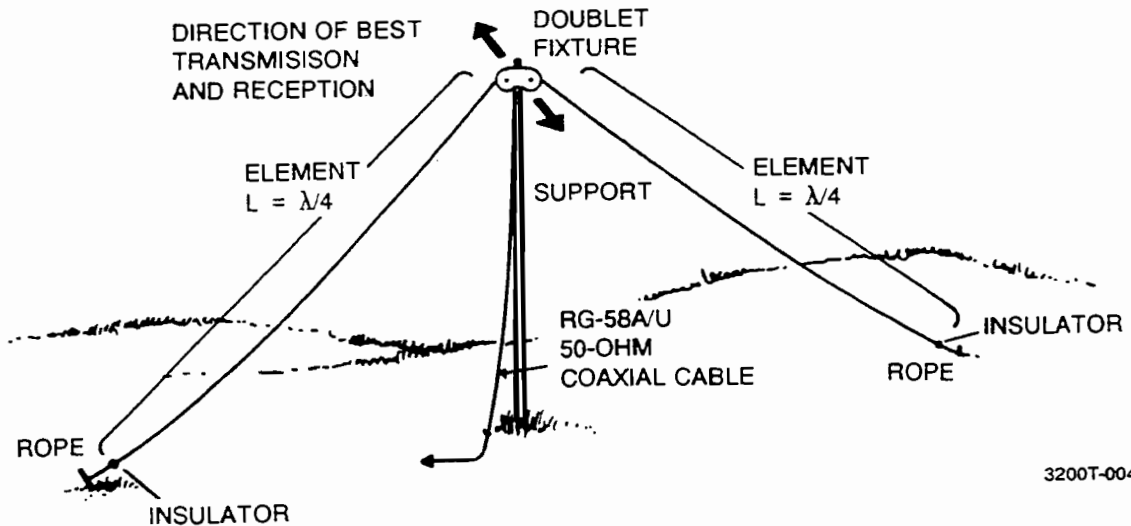

3200T-004

Figure 4. Inverted V Doublet

Deployment of the antenna system provided with the RF-3200T as a dipole is relatively simple. Refer to figure 5. The parts required to deploy the RF-3200T antenna system as a dipole are:

- 2 longwires on spool/insulators with cord and weight
- Dipole adaptor
- 30 feet of coax terminated in one UHF connector and one BNC connector
- Ground strap

The coupler is not needed for this type of installation because the antenna is deployed to be resonant at the operating frequency. If operation with a coupler is desired, the coupler should be placed at the junction of the two antenna legs, or an open-wire feeder (not included) should be used. If operating at more than one frequency, set up the dipole for the primary or lowest operating frequency. Follow the guidelines listed previously for deployment and refer to figure 5. Connect each of the long wires to the dipole adaptor and unroll the antenna to the frequency indicated on the wire labels. Secure the long wires in the notches at either end of the spools. Connect the coax provided from the transceiver ANTENNA/COUPLER connector to the dipole adaptor. Use the strain reliefs on the dipole adaptor for the long wires and the coax to prevent stressing the connectors. Secure the cords connected to the spools to the antenna supports and raise the antenna into place. Connect the ground strap to the GROUND connector on the transceiver and clip the other end to a good ground such as a cold-water pipè, a metal rod driven into the ground, or the metallic body of a vehicle. The RF-3200T is now ready to support communications needs.

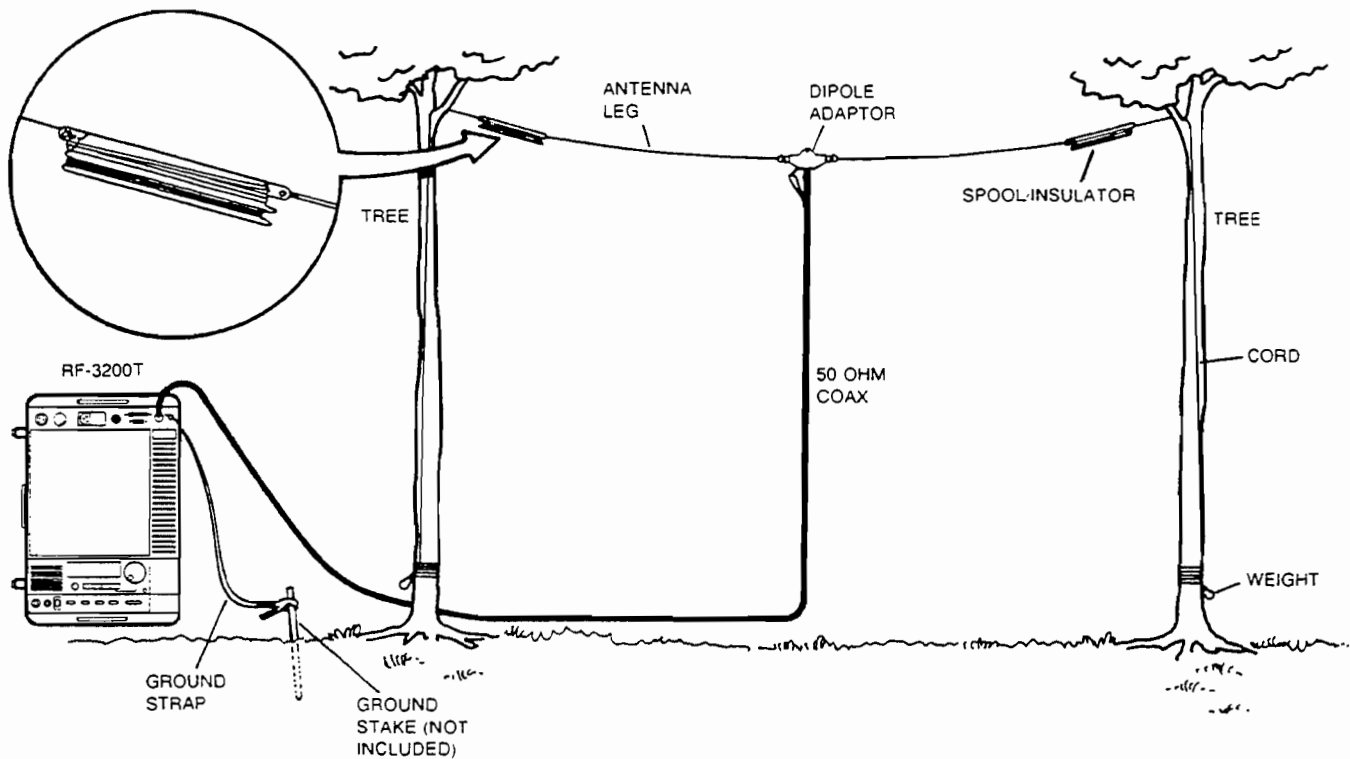

3200T-006

Figure 5. Dipole Deployment of the RF-3200T Antenna System

4.2 End-Fed Antenna (Whips and Longwires)

End-fed antennas such as whips and long wires are the quickest and easiest antenna systems to deploy. However, their performance is dependent on the effectiveness of the ground system. Long-wire antennas differ from whip antennas primarily in their electrical length in wave lengths. In general, longer end-fed antennas exhibit greater gain. A long-wire antenna is resonant if its length is a multiple of the one-quarter wavelength of the operating frequency. For safety reasons, even numbered multiples of quarter wavelengths should be avoided to minimize voltages at the ends of the long wire. If the antenna is much less than a quarter wavelength, its effectiveness is greatly reduced. For this reason, and the fact that dissipation in the automatic antenna tuner is greater for whips at low frequencies, it is not recommended that whip antennas or very short long-wire antennas be used with the RF-3200T.

4.2.1 Deployment of End-Fed Antennas

Deployment of the antenna system provided with the RF-3200T as a longwire is even easier than deployment as a dipole. Refer to figure 6. The items required for this type of deployment are listed below:

- 1 longwire on spool/insulator, with cord and weight
- 30 feet of coax terminated in one UHF connector and one BNC connector
- RF-3200T antenna coupler
- Ground strap

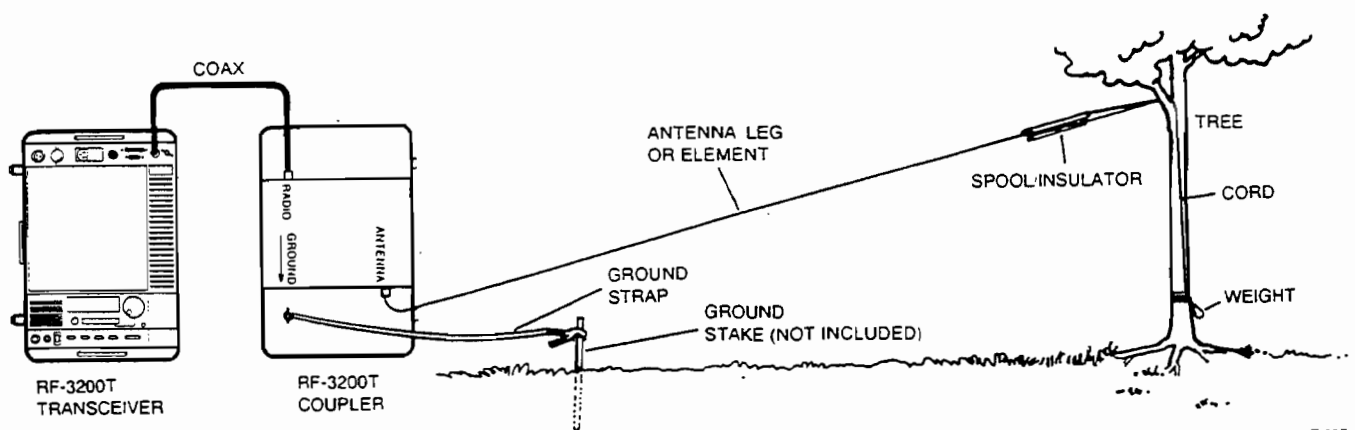

Figure 6. Long-Wire Deployment of the RF-3200T Antenna System

It is not necessary to construct a resonant longwire with the RF-3200T. A longwire of random length (maximum length is best) may be deployed as high as possible. The automatic antenna coupler will tune to the antenna in about 1 second. For safety and convenience, the coupler may be separated from the transceiver by some distance. Connect the ground strap to the GROUND connector on the coupler clip the other end to a good ground such as a cold-water pipe, a metal rod pressed into the ground, or the metallic body of a vehicle. Connect the RADIO connector on the coupler to the ANTENNA/COUPLER connector on the transceiver using the coax provided. Key the transceiver to tune the coupler and the system is ready. If a "NO TUNE" message appears in the display, change the length or position of the longwire slightly and retune.

A good ground is imperative for effective and safe HF communications with end-fed antenna systems. Often a good ground may not be available. In these situations a counterpoise may be used instead of a ground. Refer to figure 7.

WARNING

The transceiver must now be grounded to avoid RF voltages being induced on the chassis.

The optimum length for the counterpoise is one-quarter wavelength, as shown in figure 7. If operating at more than one frequency, or if a quarter-wavelength counterpoise is impractical, set up the counterpoise to the primary frequency or at the greatest length possible.

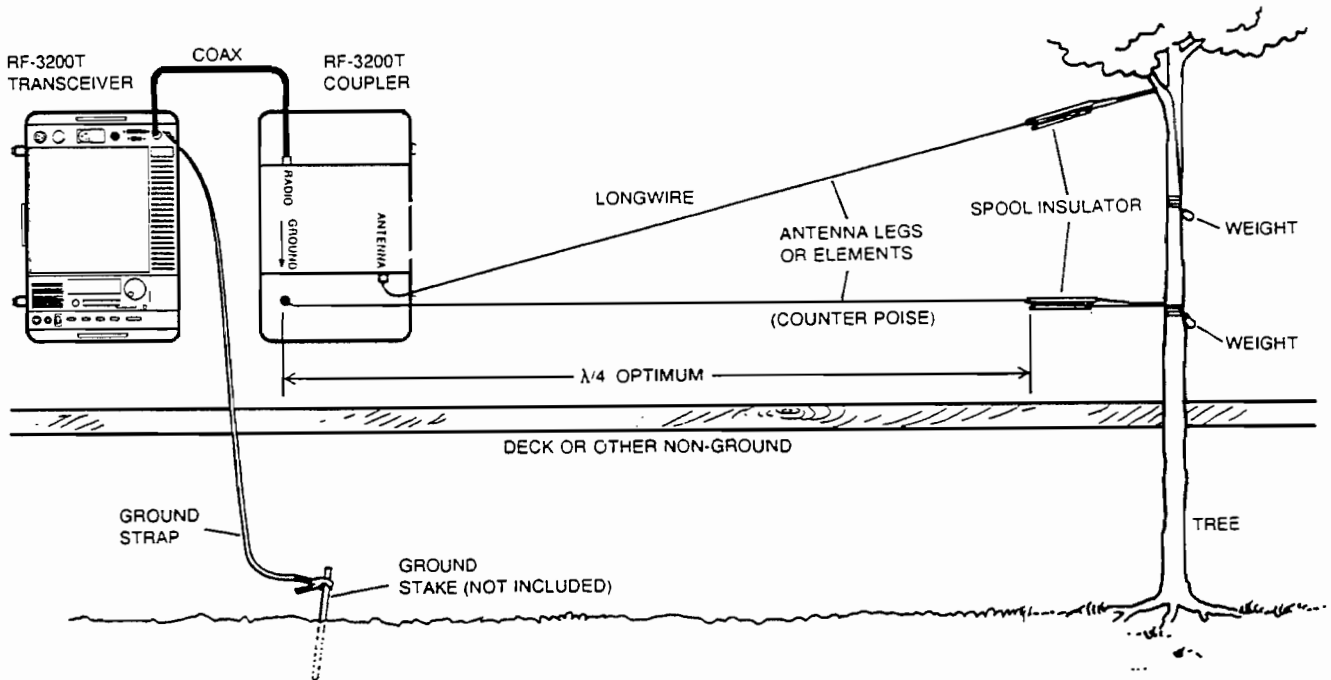

3200T-008

Figure 7. Longwire with Counterpoise Deployment of RF-3200T Antenna System

4.3 Broadband Antennas

There are many commercially available broadband antennas. Most should work at full power with the RF-3200T provided they are 50-ohm antenna systems and their VSWRs are less than 2.0:1.

APPENDIX

References for additional information on HF propagation and antenna considerations:

Field Antenna Handbook, consulting report prepared by James A. Kuch for the Department of Defense, Electromagnetic Compatibility Analysis Center, Annapolis, Maryland 21402; Report number ECAC-CR-83-200

The Radio Amateur's Handbook, American Radio Relay League: Newington, CT 06111; ISBN: 0-87259-160-3

The ARRL Antenna Book, American Radio Relay League: Newington, CT 06111; ISBN: 0-87259-414-9

Reference Data for Radio Engineers, Howard W. Sams & Co., Inc., Indianapolis, Indiana 46268; ISBN: 0-672-21218-8

Basic Radio Propagation Predictions, CRPL-D, published monthly, US Government Printing Office, Washington, DC 20402

RF-3200 USER'S GUIDE EVALUATION FORM

Manual Title: RF-3200 User's Guide
Pub. No.: 10212-0050

Harris Corporation, RF Communications Group, continually evaluates its technical publications for completeness, technical accuracy, and organization. You can assist in this process by completing and returning this form.

NAME	DATE
COMPANY/ORGANIZATION	
ADDRESS	
CITY	STATE
ZIP	COUNTRY
PHONE NO. (PLEASE INCLUDE AREA CODE)	

GENERAL COMMENTS: Please include your suggestions for improvements to the manual. Specify section, page, paragraph, figure number or table number as applicable. Attach samples or extra pages if more space is needed.

GENERAL	EXCELLENT	GOOD	FAIR	POOR
TEXT	<input type="checkbox"/>	<input type="checkbox"/>	<input type="checkbox"/>	<input type="checkbox"/>
INSTALLATION INSTRUCTIONS	<input type="checkbox"/>	<input type="checkbox"/>	<input type="checkbox"/>	<input type="checkbox"/>
OPERATION INSTRUCTIONS	<input type="checkbox"/>	<input type="checkbox"/>	<input type="checkbox"/>	<input type="checkbox"/>
TABLES	<input type="checkbox"/>	<input type="checkbox"/>	<input type="checkbox"/>	<input type="checkbox"/>
ILLUSTRATIONS	<input type="checkbox"/>	<input type="checkbox"/>	<input type="checkbox"/>	<input type="checkbox"/>
TROUBLESHOOTING INFORMATION	<input type="checkbox"/>	<input type="checkbox"/>	<input type="checkbox"/>	<input type="checkbox"/>
REFERENCE INFORMATION	<input type="checkbox"/>	<input type="checkbox"/>	<input type="checkbox"/>	<input type="checkbox"/>

GENERAL INFORMATION SECTION:

INSTALLATION SECTION:

OPERATION SECTION:

DISPLAY MESSAGES SECTION:

CARE & TROUBLESHOOTING SECTION:

REFERENCE INFORMATION SECTION:

OPTIONS SECTION:



HARRIS

HARRIS CORPORATION RF COMMUNICATIONS GROUP
1680 University Avenue Rochester, New York 14610 U.S.A.
Tel: 716-244-5830 Cable: RFCOM; Rochester, N.Y. TELEX: 240313