

Technical

Bulletin

HM-28

MICROPHONE
gj36650

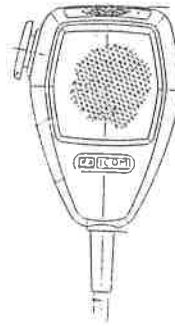

ICOM

The HM 28 is a high quality 600Ω noise cancelling dynamic microphone which is used with a IC-M700 SSB marine transceiver. The information below is provided to assist you in trouble shooting and repairing this microphone or, to determine which other microphones are compatible.

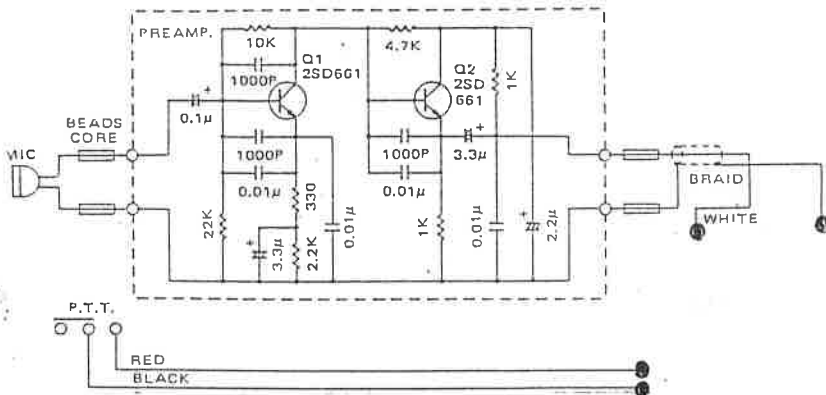

8 VDC to power mic circuit comes from the M700 via the "Hot" mic lead, (white wire).

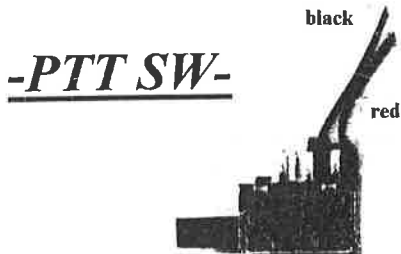
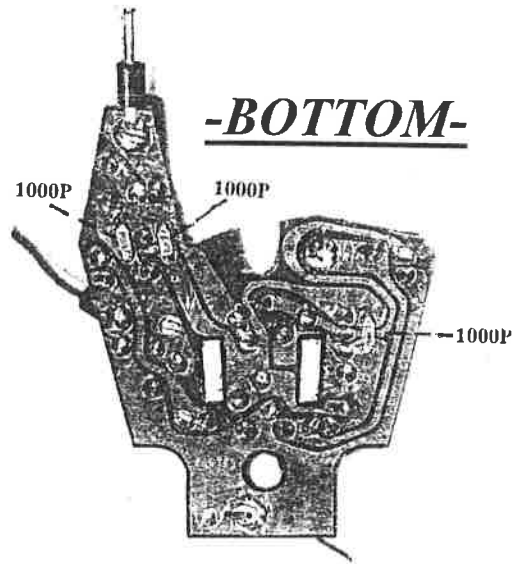
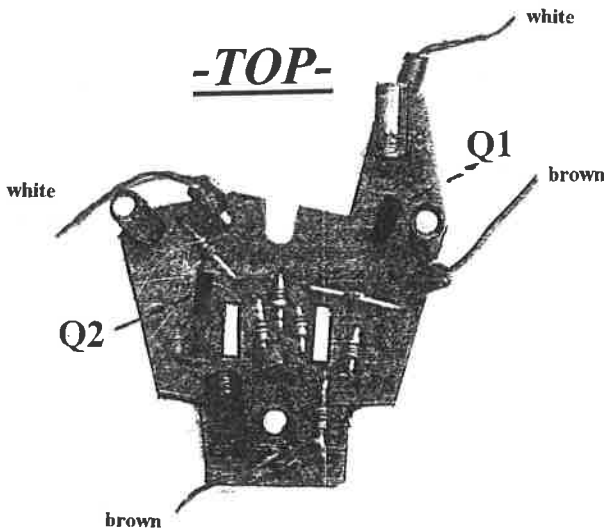

-MIC CORD-

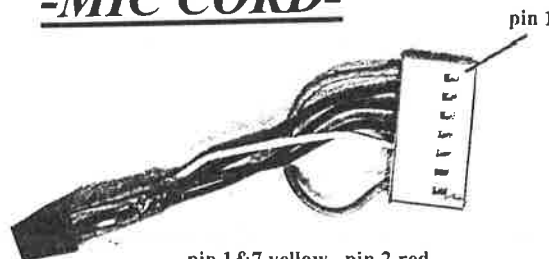

- pin 1&7 yellow
- pin 2 red
- pin 3 black
- pin 4 brown
- pin 5 white
- pin 6 nc

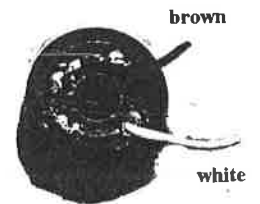

-MIC ELEMENT-