



INSTRUCTION MANUAL

MF/HF MARINE TRANSCEIVER
IC-M804



Thank you for choosing this Icom product. This product is designed and built with Icom's state of the art technology and craftsmanship. With proper care, this product should provide you with years of trouble-free operation.

IMPORTANT

READ ALL INSTRUCTIONS carefully completely before using the transceiver.

SAVE THIS INSTRUCTION MANUAL— This instruction manual contains important operating instructions for the IC-M804.

This instruction manual includes some functions that are usable only when your dealer preset them. Ask your dealer for details.

EXPLICIT DEFINITIONS

WORD	DEFINITION
⚠ DANGER!	Personal death, serious injury, or an explosion may occur.
⚠ WARNING!	Personal injury, fire hazard, or electric shock may occur.
CAUTION	Equipment damage may occur.
NOTE	If disregarded, inconvenience only. No risk of personal injury, fire or electric shock.

FEATURES

- Meets the latest ITU-R M.493-15 DSC
- RF Direct Sampling system employed
- 125 watts (PEP) of powerful output power
- NMEA 0183 (4800 to 38400 bps) and NMEA 2000 available
- IPX7 waterproof construction (remote controller only)
- Built-in Class E DSC function
The transceiver has the DSC functions for distress alert transmission and reception, as well as the general DSC calls such as Individual calls, Group calls, and so on.
- Independent Emergency channels
- Monitor Distress voice frequencies.
- Easy user interface
The remote controller has the 4.3 inches wide viewing angle and the color TFT display with Day and Night modes.
- Instant Replay function
Records the last 120 seconds of the received audio.
- Built-in GPS receiver
- AT-141 optional antenna tuner

IN CASE OF EMERGENCY

If your vessel requires assistance, contact other vessels and the Coast Guard by sending a Distress call using Digital Selective Calling (DSC) on an emergency frequency.

When immediate help is needed:

1. While lifting the key cover, hold down [DISTRESS] for 3 seconds until you hear 3 short countdown beeps and 1 long beep sound.
2. Wait for an Acknowledgment from another station.
3. After the Acknowledgment is received, hold down [PTT] on the microphone and send the following information.
 - 1 "MAYDAY, MAYDAY, MAYDAY."
 - 2 "THIS IS (name of the vessel)."
 - 3 "LOCATED AT (vessel's position)."
 - 4 Give the reason for the Distress call.
 - 5 Explain what assistance you need.
 - 6 Give additional information about your vessel:
 - Type
 - Length
 - Color
 - The number of people on board

INSTALLATION NOTE

Installation:
The installation of this equipment should be made in such a manner as to respect the EC recommended electromagnetic field exposure limits. (1999/519/EC) The maximum RF power available from this device is 150 watts. The antenna should be installed as high as possible for maximum efficiency and the installation height should be at least 2 meters above any accessible position. In the case where an antenna cannot be installed at a reasonable height, then the transmitter should neither be continuously operated for long periods if any person is within a distance of 2 meters of the antenna, nor operated at all if any person is touching the antenna.
It is recommended that antenna of a maximum gain of 0 dB is used. If higher gain antenna is required then please contact your Icom distributor for revised installation recommendations.

Operation:
The exposure to RF electromagnetic field is only applicable when this device is transmitting. This exposure is naturally reduced due to the nature of alternating periods of receiving and transmitting. Keep your transmissions to the minimum necessary.

RECOMMENDATION

CLEAN THE REMOTE CONTROLLER'S FRONT PANEL THOROUGHLY IN A BOWL OF FRESHWATER after exposure to saltwater, and dry it before operating. Otherwise, the remote controller's keys, switches may become unusable, due to salt crystallization.

① The connectors on the rear panel do not meet IPX7.

NOTE: If the remote controller's waterproof protection appears defective, carefully clean it with a soft, damp (freshwater) cloth, then dry it before operating. The remote controller may lose its waterproof protection if the case or connector cover is cracked or broken, or the remote controller has been dropped. Contact your Icom distributor or your dealer for advice.

ABOUT CE AND DOC

CE Hereby, Icom Inc. declares that the versions of IC-M804 which have the "CE" symbol on the product, comply with the essential requirements of the Radio Equipment Directive, 2014/53/EU, and the restriction of the use of certain hazardous substances in electrical and electronic equipment Directive, 2011/65/EU. The full text of the EU declaration of conformity is available at the following internet address: <https://www.icomjapan.com/support/>

DISPOSAL





The crossed-out wheeled-bin symbol on your product, literature, or packaging reminds you that in the European Union, all electrical and electronic products, batteries, and accumulators (rechargeable batteries) must be taken to designated collection locations at the end of their working life. Do not dispose of these products as unsorted municipal waste. Dispose of them according to the laws in your area.

KEY ICON DESCRIPTION

The keys are described in this manual as follows:





The keys that have words or letters on them are described with the characters "[]."

Example: [ENT], [CLR]





The Software Keys are described with the words or letters on a blue background, such as **Finish**  or **Enter** .

The functions of the keys are shown at the bottom of the display. Push the key below the desired function.

You can use the following keys on the Menu screen.

FUNCTION	ACTION
Select	Push [▲] or [▼].
Enter	Push [ENT], [CH/GRP], or Enter  .
Go to the next tree level	Push [ENT], [CH/GRP], [▶] or Enter  .
Go back to the previous tree level	Push [CLR], [◀], or Back  .
Cancel	Push [CLR].
Exit	Push Exit  .

The following action icons describe [CH/GRP], [ENT], the Keypad keys, and [◀], [▶], [▲], and [▼]

- Rotate  : Rotate [CH/GRP] to select.
- Push **ENT**  : Push [ENT] to enter or set.
- Push  : Push the Keypad keys to enter a digit or text.
- Push  : Push [◀], [▶], [▲], or [▼] to select.

PRECAUTIONS

⚠ **DANGER HIGH RF VOLTAGE! NEVER** touch an antenna or antenna connector while transmitting. This could cause an electrical shock or burn.

⚠ **WARNING! NEVER** operate the transceiver during a lightning storm. It may result in an electric shock, cause a fire or damage the transceiver. Always disconnect the power source and antenna before a storm.

⚠ **WARNING! NEVER** connect the transceiver to an AC outlet. This may pose a fire hazard and/or result in an electric shock.

⚠ **WARNING! NEVER** mount the transceiver's main unit overhead. The weight of the main unit is approximately 8.6 kg, and it could easily fall due to wave shocks or vibration. The unit must be mounted on a flat hard surface only.

⚠ **WARNING! NEVER** connect a power source of more than 12 V or 24 V DC (depending on the transceiver version). This connection could cause a fire or damage the transceiver.

⚠ **WARNING! NEVER** place the transceiver where normal operation of the vessel may be hindered or where it could cause bodily injury.

⚠ **WARNING! NEVER** let metal, wire, or other objects contact the transceiver inside or make incorrect contact with connectors on the front panel. This could cause an electric shock or damage the transceiver.

CAUTION DO NOT reverse the DC power cable polarity. This could damage the transceiver.

CAUTION: DO NOT use harsh solvents such as Benzine or alcohol when cleaning the equipment. This could damage the equipment surfaces. If the surface becomes dusty or dirty, wipe it clean with a soft, dry cloth.

CAUTION: DO NOT use or leave the transceiver in areas with temperatures below -15°C or above $+55^{\circ}\text{C}$, or in areas exposed to direct sunlight, such as the dashboard.

CAUTION: DO NOT use or leave the transceiver in excessively dusty environments.

CAUTION: DO NOT use a non-specified microphone. Other microphones may have different pin assignments and may damage the transceiver.

NEVER place the transceiver in an insecure place to avoid inadvertent use by unauthorized persons.

BE CAREFUL! The transceiver's main unit may become hot after continuously transmitting for long periods of time.

BE CAREFUL! The remote controller's front panel meets IPX7 requirements for waterproof protection. However, once the remote controller has been dropped and cracked, or the waterproof seal is cracked or damaged, waterproof protection cannot be guaranteed.

① The connectors on the rear panel do not meet IPX7.

NOTE: Install the transceiver and microphone at a distance of more than 1 meter from the vessel's magnetic navigation compass.

The LCD display may have cosmetic imperfections that appear as small dark or light spots. This is not a malfunction or defect, but a normal characteristic of LCD displays.

Icom is not responsible for the destruction, damage to, or performance of any Icom or Non-Icom equipment, if the malfunction is because of:

- Force majeure, including, but not limited to, fires, earthquakes, storms, floods, lightning, other natural disasters, disturbances, riots, war, or radioactive contamination.
- The use of Icom transceivers with any equipment that is not manufactured or approved by Icom.

Icom, Icom Inc. and the Icom logo are registered trademarks of Icom Incorporated (Japan) in Japan, the United States, the United Kingdom, Germany, France, Spain, Russia, Australia, New Zealand, and/or other countries.

NMEA 2000 is a trademark of the National Maritime Electronics Association, Inc.

All other products or brands are registered trademarks or trademarks of their respective holders.

TABLE OF CONTENTS

IMPORTANT.....	i	Assigning a function.....	18	◇ DSC Frequency.....	47
EXPLICIT DEFINITIONS.....	i	◇ Assigning a Software Key function to a Software Key.....	18	◇ Scanning Receiver.....	48
FEATURES.....	i	◇ Assigning a Software Key function to [VOL].....	19	◇ Auto ACK.....	49
IN CASE OF EMERGENCY.....	i	◇ Assigning a Software Key function to [P] on the supplied microphone.....	19	◇ CH Auto Switch.....	50
INSTALLATION NOTE.....	i	6 DSC OPERATION.....	20	◇ NMEA Data Output.....	50
RECOMMENDATION.....	ii	About DSC.....	20	◇ Alarm Status.....	51
ABOUT CE AND DOC.....	ii	DSC address ID.....	20	◇ Self Check Test.....	52
DISPOSAL.....	ii	◇ Entering an Individual or Group ID	20	7 MENU SCREEN.....	53
KEY ICON DESCRIPTION.....	ii	◇ Delete an entered ID.....	21	About the Menu screen.....	53
PRECAUTIONS.....	iii	Entering the position data and time..	22	Selecting the item.....	53
1 OPERATING RULES.....	1	DSC Task mode.....	23	Menu Construction.....	54
2 PANEL DESCRIPTION.....	2	◇ Software Key functions.....	23	GPS Information.....	56
Main unit front panel.....	2	◇ Unread List.....	23	Configuration.....	56
Remote Controller front panel.....	3	Sending DSC calls (Distress).....	24	Radio Settings.....	58
Microphone.....	4	◇ Simple call.....	24	Radio Information.....	60
Optional HS-98.....	4	◇ Regular call.....	25	8 CONNECTIONS AND INSTALLATION.....	61
◇ About the Speaker Switch.....	4	◇ Resending a Distress call.....	26	Supplied accessories.....	61
Software Keys.....	4	◇ Distress Cancel call.....	27	Connections.....	62
◇ Selecting a Software Key function..	4	Sending DSC calls (other).....	29	◇ Basic connections.....	62
◇ Functions.....	5	◇ Sending an Individual call.....	29	◇ Advanced connections.....	63
Function display (Main screen).....	6	◇ Sending an Individual Acknowledgment.....	30	◇ Connecting the microphone.....	63
◇ Status area.....	6	◇ Sending a Group call.....	31	◇ Connecting the remote control cable.....	64
◇ Task area.....	6	◇ Sending a Geographical Area call	33	Ground connection.....	64
◇ Information area.....	6	◇ Sending a Position Request Acknowledgment.....	35	Power source.....	65
◇ Channel area.....	6	◇ Sending a Test call.....	36	Antenna.....	65
◇ Software Key area.....	7	◇ Sending a Test call Acknowledgment.....	37	Mounting.....	66
◇ Position and Time area.....	7	Receiving DSC calls (Distress).....	38	◇ Mounting location.....	66
3 PREPARATION.....	8	◇ Receiving a Distress call.....	38	◇ Mounting the remote controller..	66
Entering the MMSI code.....	8	◇ Receiving a Distress Acknowledgment.....	39	◇ Mounting the main unit.....	67
4 BASIC OPERATION.....	9	◇ Receiving a Distress Cancel call..	39	MB-75 installation.....	68
Selecting a Channel or Group.....	9	◇ Receiving a Distress Relay call..	40	MB-108 installation.....	69
◇ Using the channel and group selector.....	9	◇ Receiving a Distress Relay Acknowledgment.....	40	Fuse replacement.....	70
◇ Using the Keypad keys.....	9	Receiving DSC calls (other).....	41	Connector information.....	71
◇ Channel and Channel Group list..	9	◇ Receiving an Individual call.....	41	9 SPECIFICATIONS AND OPTIONS.....	73
Receiving and transmitting.....	10	◇ Receiving an Individual Acknowledgment.....	42	Specifications.....	73
◇ Receiving.....	10	◇ Receiving a Group call.....	43	◇ General.....	73
◇ Transmitting.....	10	◇ Receiving a Geographical Area call.....	44	◇ Transmitter.....	73
DSC Scan.....	10	◇ Receiving a Position Request call	44	◇ Receiver.....	73
FSK operation.....	11	◇ Receiving a Test call.....	45	Transceiver dimensions.....	74
◇ Connecting an FSK terminal unit..	11	◇ Receiving a Test Acknowledgment	45	Options.....	74
5 OTHER FUNCTIONS AND OPERATIONS.....	12	DSC Log.....	46	◇ Antenna tuner.....	74
Backlight function.....	12	◇ Received DSC Log.....	46	◇ Microphone.....	74
Instant Replay function.....	12	◇ Transmitted DSC Log.....	46	◇ Others.....	74
◇ Playback the recorded voice.....	12	DSC Settings.....	47	TROUBLESHOOTING.....	75
Scan.....	13	TEMPLATE.....	76	INDEX.....	78
◇ CH and CH Resume.....	13	INDEX.....	78		
◇ Program.....	13				
Other functions.....	14				
Setting a temporary operating frequency.....	16				
Setting a User channel or an ITU Simplex channel.....	17				

NOTE: Before transmitting, monitor the channel you want to use to avoid interrupting communications already in progress.

● CALL PROCEDURE

Calls must be properly identified and the time limit must be respected.

1. Give your call sign each time you call another ship or Coast Guard station. If you have no call sign, identify the station by giving your ship name and the name of the licensee.
2. Give your call sign at the end of each transmission that lasts more than 3 minutes.
3. You must break and give your call sign at least once every 15 minutes during long ship-to-shore calls.
4. Keep your unanswered calls short, less than 30 seconds. Do not repeat a call for 2 minutes.
5. Unnecessary transmissions are not allowed.

● PRIORITIES

1. Read all rules and regulations pertaining to priorities and keep an up-to-date copy handy. Safety and Distress calls take priority over any other calls.
2. False or fraudulent Distress signals are prohibited and punishable by law.

● PRIVACY

1. Information overheard, but not intended for you, cannot lawfully be used in any case.
2. Indecent or profane language is prohibited.

● LOGS

1. All Distress, Emergency and Safety calls must be recorded in complete details. Log data activity is usually recorded for 24 hours. Universal Time Coordinated (UTC) is frequently used.
2. Keep adjustments, repairs, channel frequency changes and authorized modifications affecting electrical operation of the equipment in the maintenance log. The entries requires signatures by the authorized licensed technician performing or supervising the work.

● RADIO LICENSES

(1) SHIP RADIO STATION LICENSE

You need a current ship radio station license before using the transceiver. It is unlawful to operate a ship radio station which is not licensed, but required to be.

If required, contact your dealer or the appropriate government agency for a Ship-Radiotelephone license application. This government-issued license states the call sign which is your craft's identification for radio communication purposes.

(2) OPERATOR'S LICENSE

A Restricted Radiotelephone Operator Permit is the license most often held by small vessel radio operators when a radio is not required for safety purposes.

If required, the Restricted Radiotelephone Operator Permit must be posted, or kept with the operator. If required, only a licensed radio operator may operate a transceiver.

However, non-licensed individuals may talk over a transceiver if a licensed operator starts, supervises, ends the call, and makes the necessary log entries.

A current copy of the applicable government rules and regulations is only required to be on hand for vessels in which a radio telephone is compulsory. However, even if you are not required to have these on hand it is your responsibility to be thoroughly acquainted with all pertinent rules and regulations.

■ Main unit front panel

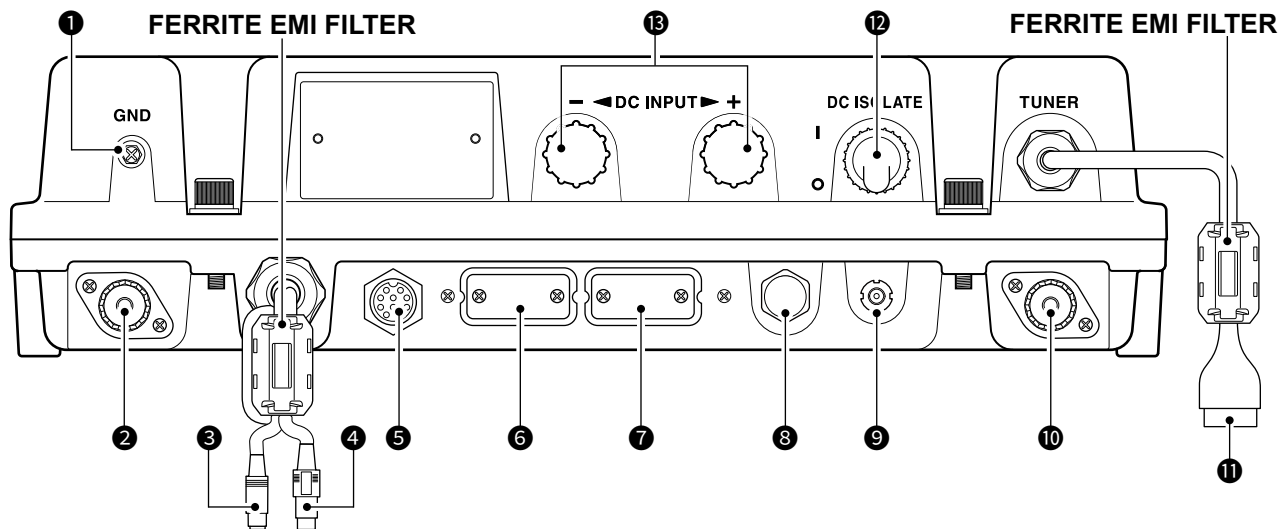

① GROUND TERMINAL [GND] (p. 64)

Connects to the vessel's ground.

② DSC ANTENNA CONNECTOR (p. 62)

Connects to a 50 Ω HF marine band antenna through a 50 Ω PL-259 coax for a DSC receiver. This antenna is used for receiving Distress calls.

NOTE: To receive a Distress call, **BE SURE** to connect an HF marine band antenna to this antenna connector. Otherwise, you cannot receive any Distress calls.

③ SPEAKER JACK [SP] (p. 62)

Connects to the optional SP-24E or an external speaker.

NOTE: When an external speaker is connected, the internal speaker is automatically muted.

④ GPS JACK [GPS-DATA] (pp. 63, 71)

Connects to a GPS receiver to input position and UTC data for DSC operations. (NMEA 0183 ver. 4.10 format)

① An NMEA ver. 4.10 (sentence formatter: GGA, GLL, GNS, RMC, VTG) compatible GPS receiver is required. Ask your dealer about suitable GPS receivers.

⑤ CONTROLLER CONNECTOR [CONTROLLER] (p. 62)

Connects to the supplied remote controller.

⑥ MODEM CONNECTOR [AF/MOD] (pp. 63, 71)

Connects to an external terminal unit for SSB mode operation through an RS-232C cable (D-sub 9-pin).

NOTE: When connecting an external unit, detach the cover.

⑦ REMOTE CONNECTOR [REMOTE] (pp. 63, 72)

Connect a PC through a USB to RS-422A (D-sub 9 pin) cable for remote control.

NOTE: When connecting an PC, detach the cover.

⑧ NMEA 2000 CONNECTOR [NMEA 2000] (pp. 63, 72)

Connects to the NMEA 2000 network.

NOTE: When connecting to the NMEA 2000 network, detach the cap.

⑨ GPS ANTENNA CONNECTOR [GPS-ANT] (p. 63)

Connects to the supplied GPS antenna.

NOTE: Install the GPS antenna where it has a clear view to receive signals from satellites.

⑩ ANTENNA CONNECTOR (p. 62)

Connects to a dipole antenna or an automatic antenna tuner through a 50 Ω PL-259 coax to transmit and receive any calls other than Distress calls.

⚠ WARNING! NEVER directly connect the antenna to this connector.

⑪ TUNER CONTROL SOCKET [TUNER] (pp. 62, 71)

Connects to the control cable of the supplied AT-141 HF AUTOMATIC ANTENNA TUNER. A female connector kit is supplied to connect the AT-141.

⑫ POWER SWITCH [DC ISOLATE]

Turns the transceiver's main power ON or OFF.

⑬ DC POWER SOCKET [DC INPUT] (p. 65)

Connects to a 12 or 24 V DC power source through the supplied DC power cables. The red terminal is positive (+), and the black terminal is negative (-).

Remote Controller front panel

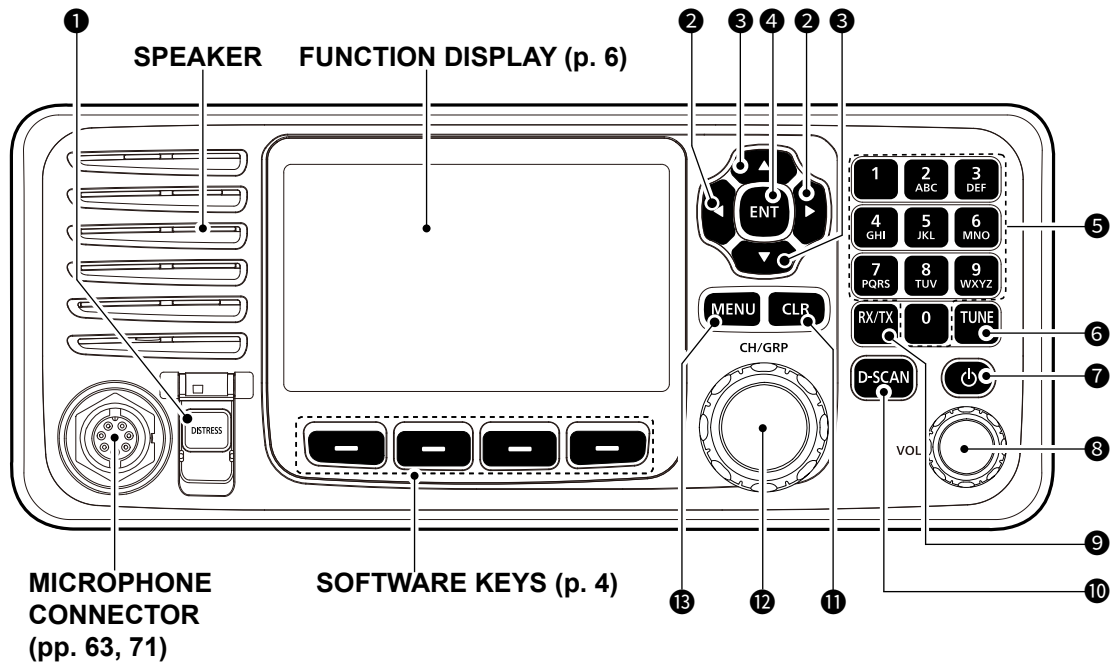

1 DISTRESS KEY [DISTRESS]

Hold down for 3 seconds to transmit a Distress call. (p. 24)

2 LEFT AND RIGHT KEYS [◀]/[▶]

- Push to scroll the Software Key functions. (p. 4)
- In the Character or Number Entry mode, push to select a character or number in the table.

3 UP AND DOWN KEYS [▲]/[▼]

- Push to select an operating channel, menu items, menu settings, and so on.

4 ENTER KEY [ENT]

Push to set the entered data, selected item, and so on.

5 KEYPAD KEYS

Push to enter numbers, letters, or symbols.

6 TUNE KEY [TUNE]

When the AT-141 is connected:

- Push to start manual tuning or to bypass the tuning circuit.
- Hold down to start manual tuning.
 - ① "TUNE" is displayed after tuning is completed.
 - ① "THRU" is displayed if the tuner cannot tune the antenna.

When the other antenna tuner is connected:

- Push to start manual tuning.

7 POWER KEY [⏻]

Hold down for 1 second to turn the transceiver ON or OFF.

8 VOLUME DIAL [VOL]

- Rotate to adjust the speaker volume level.
- Push 1 ~ 5 times to display the setting screens.

Pushing once	The Volume Setting window is displayed.
Pushing twice	The NB Level Setting window is displayed.
Pushing 3 times	The S-SQL Level Setting window is displayed.
Pushing 4 times	The RF Gain Setting window is displayed.
Pushing 5 times	The Backlight Settings window is displayed.

9 RX/TX KEY [RX/TX]

Push to set a temporary operating frequency. (p. 16)

10 DSC SCAN KEY [D-SCAN]

Push to start a DSC scan. (p. 10)

11 CLEAR KEY [CLR]

Push to cancel the entered data or to return to the previous screen.

12 CHANNEL/GROUP SELECTOR [CH/GRP]

- Push to select the Channel Select mode or the Group Select mode. (p. 9)
- Push to set the entered data, selected item, and so on.
- Rotate to select the operating channel, menu items, menu settings, and so on.

13 MENU KEY [MENU]

Push to enter or exit the Menu screen.

■ Microphone

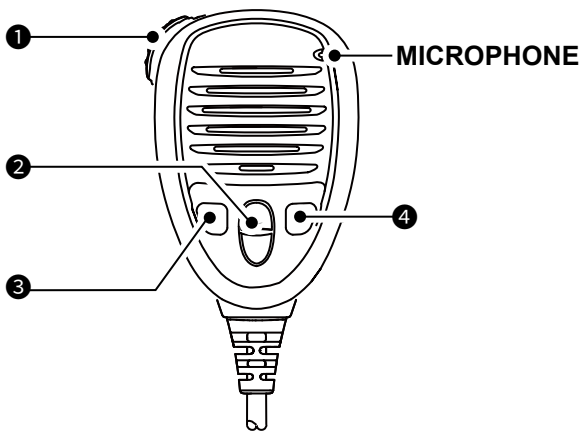

- 1 PTT SWITCH**
Hold down to transmit, release to receive.
- 2 UP/DOWN KEYS [▲]/[▼]**
Push to select an operating channel or group.
- 3 PROGRAMMABLE KEY [P]**
Push to activate a preset Software Key function.
Ask your dealer for details.
 - ① You can reassign some Software Key functions to the key. (p. 18)
- 4 DSC SCAN KEY [D-SCAN]**
Push to start the DSC scan. (p. 10)

■ Optional HS-98

◇ About the Speaker Switch

When the switch is set to the “” position:
You can hear the received audio from the remote controller’s speaker.

When the switch is set to the “” position:
The remote controller speaker output is muted.
• You can hear the received audio from the handset.
To output the received audio from the remote controller’s speaker, put the handset into the cradle.

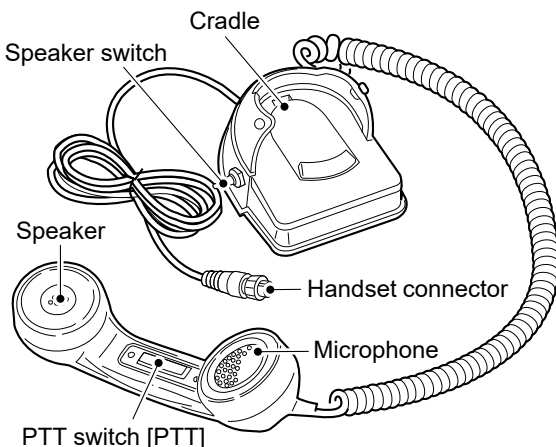

■ Software Keys

Various often-used functions are assigned to the Software Keys for easy access. The function’s icons are displayed above the Software Keys, as shown below.

◇ Selecting a Software Key function

Push [◀] or [▶] to slide through the selectable functions that are assigned to the Software Keys. To select the function, push the Software Key under the function’s icon.

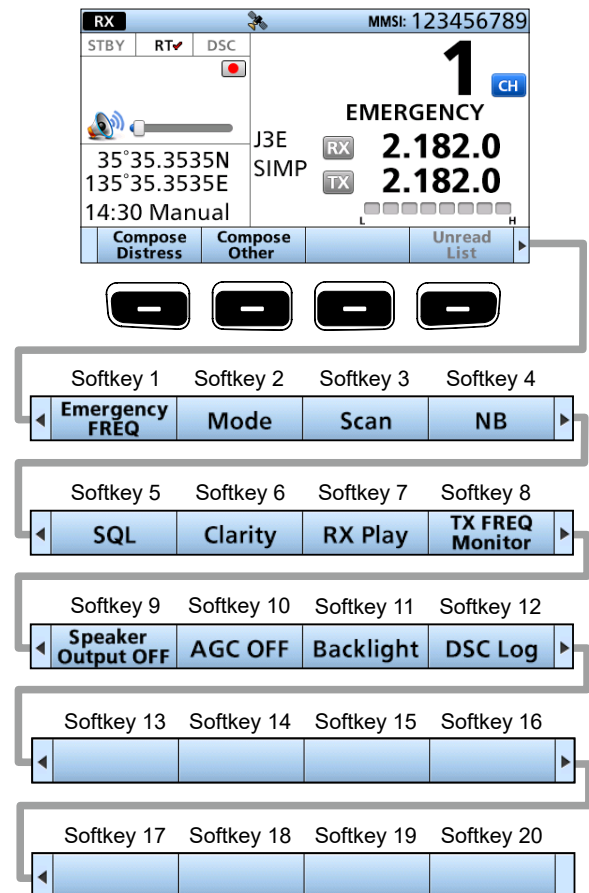

- ① The key function may differ, depending on the transceiver version or presetting.

2 PANEL DESCRIPTION

■ Software Keys

◇ Functions

You can use various Software Key functions that are assigned to the Software Keys, as described below.

Compose Distress

Push to compose a Distress call. (pp. 25 ~ 29)

Compose Other

Push to compose DSC calls other than Distress calls. (pp. 29 ~ 37)

Unread List

Push to check unread DSC messages. (p. 23)

Emergency FREQ

Push to use the Distress Voice frequency. (p. 14)

Mode

Push to select the J3E, H3E, LSB, J2B, F1B, or A1A operating mode.

Scan

Push to start or stop a scan. (p. 13)

NB

Push to turn the Noise Blanker (NB) function ON or OFF. (p. 14)

NB Level

Push to adjust the Noise Blanker (NB) level. (p. 14)

SQL

Push to turn the Squelch function ON or OFF. (p. 14)

S-SQL Level

Push to adjust the S-meter Squelch (S-SQL) level. (p. 14)

RF Gain

Push to adjust the Radio Frequency (RF) Gain level. (p. 14)

Clarity

Push to turn the Clarity Control function ON or OFF. (p. 14)

RX Play

Push to replay the recorded audio data. (p. 12)

TX FREQ Monitor

Push to check and monitor the transmit frequency. (p. 15)

Speaker Output OFF

Push to turn the speaker output ON or OFF. (p. 15)

AGC OFF

Push to turn the Automatic Gain Control (AGC) function ON or OFF. (p. 15)

Backlight

Push to change the backlight brightness level. (p. 12)

DSC Log

Push to check the received DSC calls. (p. 46)

TIP: You can reassign the function's place to meet your needs between Softkey 1 and Softkey 20. See page 18 for details.

① The first set of Software Key functions ([Compose Distress], [Compose Other], and [Unread List]) are fixed and cannot be reassigned.

② When the MMSI code is not set, the Software Keys for the DSC function are not displayed.

■ Function display (Main screen)

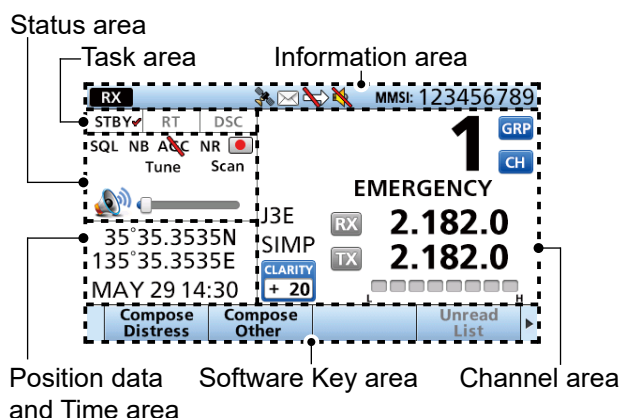

◇ Status area

The current status is displayed in the Status area.

Indicator	Description
SQL	Displayed when the Squelch function is ON.
NB	Displayed when the Noise Blanker function is ON.
AGC	Displayed when the AGC function is OFF.
NR	Displayed when the Noise Reduction function is ON.
	• Displayed when the received audio is recorded. (p. 12)
	• Displayed when recording the received audio is stopped. (p. 12)
Tune	Displayed when the Tune function is ON.
Scan	Displayed during a scan.
	• Displayed when the volume is set to between 1 to 20.
	• Displayed when the volume is set to 0.

◇ Task area

The current mode is displayed in the Task area.

Indicator	Description
STBY	Displayed while in the Standby mode.
RT	Displayed while in the Radio Telephone (RT) mode. ① Returns to the Standby mode if no operation occurs during the preset period of time.
DSC	Displayed after making or receiving a DSC call.

◇ Information area

The 9 digit MMSI (Maritime Mobile Service Identity: DSC self ID) code and the following indicators are displayed in the information area.

Indicator	Description
	Displayed when receiving a signal or when the squelch is open.
	Displayed while transmitting.
	<ul style="list-style-type: none"> • Displayed when the GPS receiver is activated and valid position data is received. • Blinks while invalid position data is being received.
	<ul style="list-style-type: none"> • Displayed when there is an unread DSC message. • Blinks when there is a new DSC message.
	Displayed when the "CH Auto Switch" in the DSC settings is set to an option except "Accept after 10 sec."
	Displayed when the internal speaker is OFF.

◇ Channel area

The selected operating channel number, channel name, and the following indicators are displayed in the Channel area.

Indicator	Description
	Displayed when the Channel Select mode is selected.
	Displayed when the Group Select mode is selected.
	Displayed when the Clarity function is ON. The number is the added to (+) or subtracted from (-) the frequency.
	Displayed when the Emergency FREQ channel is selected.
	When receiving, the S meter displays the relative signal strength.
	When transmitting, the Current meter displays the output power level.
SIMP	Displayed when a Simplex channel is selected.
DUP	Displayed when a Duplex channel is selected.
J3E/H3E/LSB/J2B/F1B/A1A	Displays the selected operating mode.

2 PANEL DESCRIPTION

■ Function display (Main screen)

◇ Software Key area

The Key function for each Software Key is displayed.
See page 4 for details.

◇ Position and Time area

Position area

The current position is displayed when valid GPS data is received, or when your position is manually entered.

Indicator	Description
No Position	Displayed when a GPS receiver is not connected and the position data has not been manually entered.
??	Blinks every 2 seconds instead of the position when the GPS position data is not correctly received. ① The last position is held for only 23.5 hours. After that, "No Position" will be displayed.
	Blinks every 2 seconds instead of the position after 4 hours have passed since the position data was manually entered. ① The manually entered data is held for only 23.5 hours. After that, "No Position" will be displayed.

Date and Time area

- The current time is displayed when valid GPS data is received or when the time is manually entered.
- The date information is displayed when the RMC GPS sentence formats are included in the GPS signal.

Indicator	Description
No Time	Displayed when a GPS receiver is not connected and the time has not been manually entered.
Local	Displayed when the offset time is set.
Manual	Displayed when the time is manually entered.
??	Blinks every 2 seconds instead of the time when the GPS current time is not correctly received. ① After 23.5 hours have passed, "No Time" will be displayed.
	Blinks every 2 seconds instead of the time after 4 hours have passed since the time was manually entered. ① The manually entered time is held for only 23.5 hours. After that, "No Time" will be displayed.

■ Entering the MMSI code

The Maritime Mobile Service Identity (MMSI: DSC self ID) code consists of 9 digits. You can only enter the code when turning ON the transceiver for the first time.

This initial code can be entered only once.
 After entering, it can be changed only by your dealer or distributor.
 If your MMSI code has already been entered, doing the steps below is not necessary.

1. Hold down [⏻] to turn ON the transceiver.
 - Three short beeps sound, and then “Push [ENT] to Register your MMSI” is displayed.

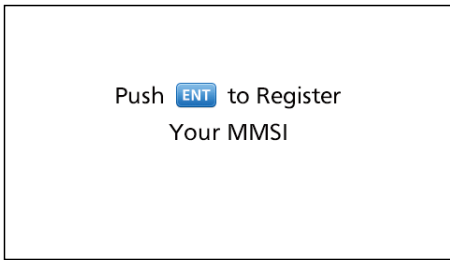

2. Push [ENT] to start entering the MMSI code.
 - The “MMSI” screen is displayed.
 - ① To skip the entry, push [CLR] twice.
 If you skip the entry, you cannot make a DSC call. To enter the code after skipping, turn OFF the power, and then turn it ON again.

3. Enter the MMSI code.

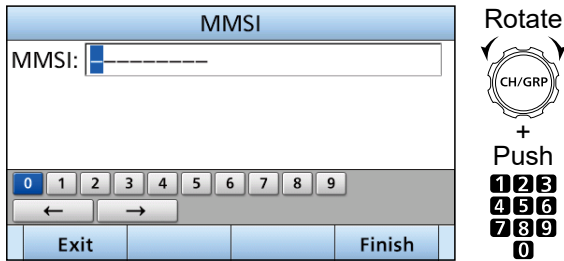

4. Repeat step 3 to enter all 9 digits.
5. Push the Software key [Finish] to set the entered code.

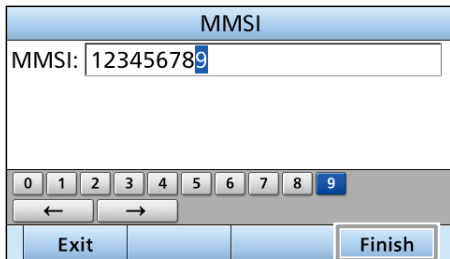

- The “MMSI CONFIRMATION” screen is displayed.

6. Enter your MMSI code again to confirm.

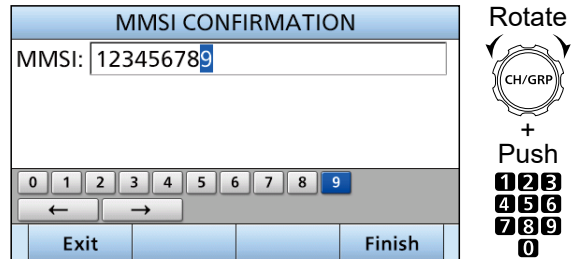

7. Push [Finish] to set the confirmation code.



- When your MMSI code is successfully entered, “MMSI Successfully Registered” is briefly displayed, and then the Main screen opens.
- ① Your MMSI code is also displayed on the opening screen.

2
3

■ Selecting a Channel or Group

◇ Using the channel and group selector

1. Push [CH/GRP] to toggle between the Channel Select mode and the Group Select mode.
 - CH or GRP is displayed.
2. Rotate [CH/GRP] to select a channel or group.
 - ① When selecting the Group Select mode, the User channels change in 20 channel steps.

NOTE: See the Channel and Channel Group list below.

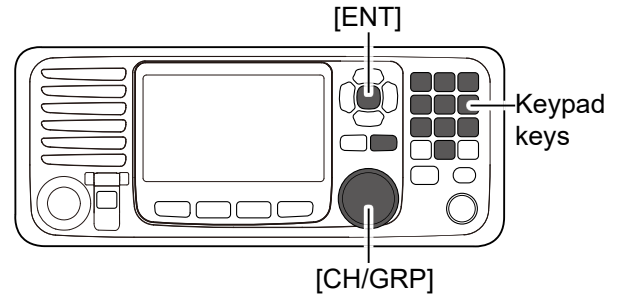

- Channel Select mode
- Group Select mode

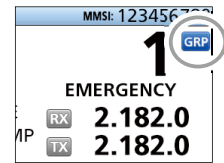
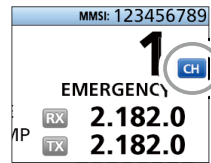

◇ Using the Keypad keys

- When selecting a User channel, an ITU duplex channel, or an ITU FSK channel

1. Push the Keypad keys to enter the channel number.
2. Push [ENT] to set.

Example:

- Selecting CH 1: [1] → [ENT]
- Selecting CH 41: [4] → [1] → [ENT]
- Selecting CH 101: [1] → [0] → [1] → [ENT]
- Selecting CH 1815: [1] → [8] → [1] → [5] → [ENT]
- Selecting CH 22026: [2] → [2] → [0] → [2] → [6] → [ENT]

NOTE:

- See the Channel and Channel Group list below.
- Pushing [CLR] clears the entered digits and returns to the previous channel.

- When selecting an ITU simplex channel

1. Push the Keypad keys to select a frequency band.
2. Push the left most Software Key to enter a “-” (dash).
3. Push the Keypad keys to enter the channel number.

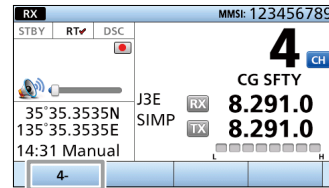

4. Push [ENT] to set.

Example:

- Selecting CH 4-1: [4] → [4-] → [1] → [ENT]
- Selecting CH 25-9: [2] → [5] → [25-] → [9] → [ENT]

◇ Channel and Channel Group list

Channel No.	Description
1 ~ 160	User CH
401 ~ 429	4 MHz ITU duplex CH
4-1 ~ 4-9	4 MHz ITU simplex CH
601 ~ 608	6 MHz ITU duplex CH
6-1 ~ 6-9	6 MHz ITU simplex CH
801 ~ 837	8 MHz ITU duplex CH
8-1 ~ 8-9	8 MHz ITU simplex CH
1201 ~ 1241	12 MHz ITU duplex CH
12-1 ~ 12-9	12 MHz ITU simplex CH
1601 ~ 1656	16 MHz ITU duplex CH
16-1 ~ 16-9	16 MHz ITU simplex CH
1801 ~ 1815	18 MHz ITU duplex CH
18-1 ~ 18-9	18 MHz ITU simplex CH
2201 ~ 2253	22 MHz ITU duplex CH
22-1 ~ 22-9	22 MHz ITU simplex CH

Channel No.	Description
2501 ~ 2510	25 MHz ITU duplex CH
25-1 ~ 25-9	25 MHz ITU simplex CH
C1-1 ~ C1-21	C1 channels
C2-1 ~ C2-31	C2 channels
4001 ~ 4013	4 MHz ITU FSK CH
6001 ~ 6014	6 MHz ITU FSK CH
8001 ~ 8015	8 MHz ITU FSK CH
12001 ~ 12092	12 MHz ITU FSK CH
16001 ~ 16031	16 MHz ITU FSK CH
18007 ~ 18020	18 MHz ITU FSK CH
22013 ~ 22026	22 MHz ITU FSK CH

- ① When selecting the Group Select mode, the User channels change in 20 channel steps.

■ Receiving and transmitting

◇ Receiving

1. Select a channel by rotating [CH/GRP] or pushing the Keypad keys. (p. 9)
2. When receiving a call, rotate [VOL] to adjust the audio output level.

TIP:

When a call is received:

- **RX** is displayed.
- You can hear received audio from the speaker.
- The S-meter displays the received signal strength.

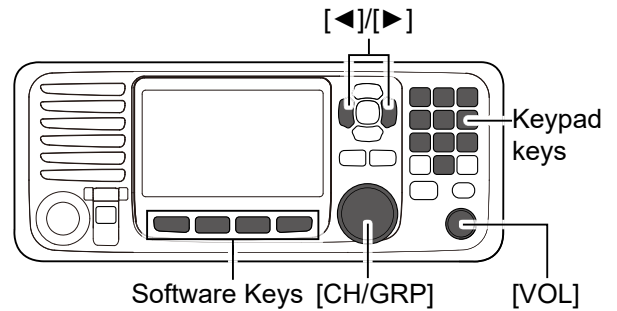

◇ Transmitting

1. Select a channel by rotating [CH/GRP] or pushing the Keypad keys. (p. 9)
2. Push [◀] or [▶] until **TX FREQ Monitor** is displayed in the Software Key area.
3. Hold down **TX FREQ Monitor**  to temporarily monitor the transmit frequency of the selected channel.
 - **TX** blinks while holding down.

NOTE: If the channel is busy, wait until it becomes clear or change to another channel.

4. Hold down [PTT] on the handset and speak into the microphone at your normal voice level.
 - **TX** is displayed while transmitting.

NOTE: If “SWR” is displayed during transmission, check your antenna system.

5. Release [PTT] to receive.
 - **RX** is displayed.

NOTE: The Time-out Timer function cuts OFF transmission after 16 minutes of continuously transmitting.

TIP: To maximize the readability of your transmitted signal, pause for a second after holding down [PTT]. Hold the microphone 5 to 10 cm from your mouth, and then speak at your normal voice level.

■ DSC Scan

To receive a DSC call, such as an Individual call or a Group call, push [D-SCAN] to enter the DSC watch mode.

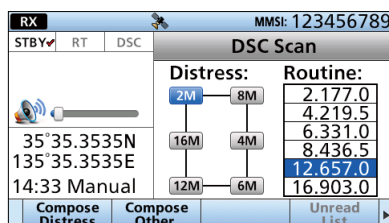

DSC watch mode

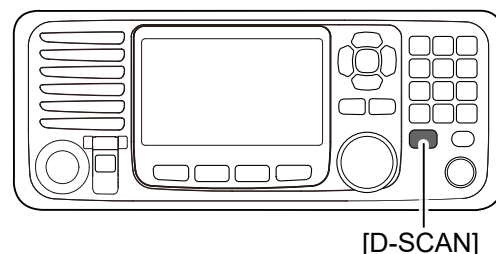

NOTE: The following frequencies are always automatically monitored with this transceiver.

2187.5, 4207.5, 6312.0, 8414.5, 12577.0, and 16804.5 kHz

① The setting for monitoring these frequencies can be changed in the Scanning Receiver setting. (p. 48)

4 BASIC OPERATION

■ FSK operation

The transceiver has F1B (FSK) and J2B (AFSK) modes for FSK operation. Select “F1B” when using the built-in oscillator, and select “J2B” when using an AFSK terminal unit.

◇ Connecting an FSK terminal unit

1. Connect an FSK terminal unit to the [AF/MOD] socket, as shown to the right.
2. Select the channel to operate in the FSK mode.
① ITU FSK channel group, Ch 4001 to Ch 22026, are usable only when the “ITU FSK CH” setting is set to “ON.” (p. 59)
3. Push [◀] or [▶] until **Mode** is displayed in the Software Key area.
4. Push **Mode**  several times to select “F1B” or “J2B.”
5. Operate using the FSK terminal unit.

NOTE:

- The FSK mark frequency, shift frequency, and polarity can be selected in the FSK Settings. (p. 59)
- Some transceivers may operate 1.7 kHz higher than the IC-M804's J2B mode, even when the same displayed frequencies are in use.

FSK terminal unit connection

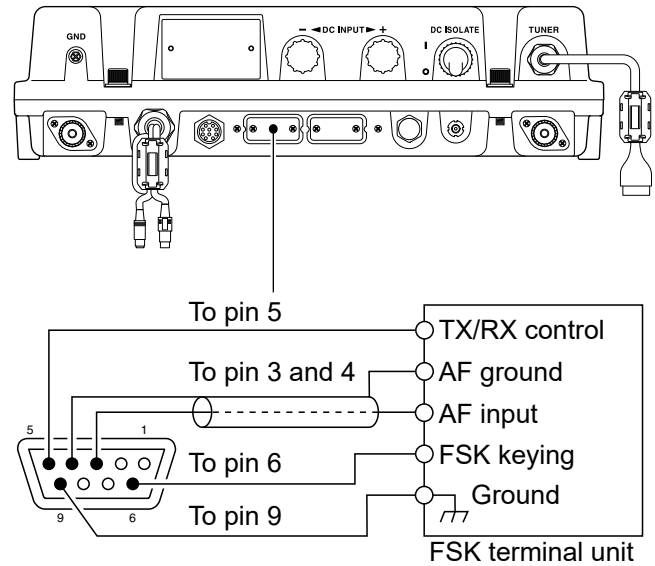

■ Backlight function

The function display and keys can be backlit for better visibility under low light conditions.

You can set the LCD backlight mode to Day mode or Night mode. The Day mode is for the daytime operation, and the screen items are in color. The Night mode is for nighttime operation, and the screen items are displayed in black and red.

1. Push [◀] or [▶] until **Backlight** is displayed in the Software Key area.
2. Push **Backlight**  to open the Backlight Settings window.

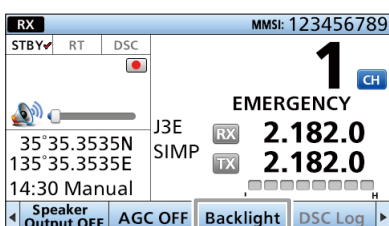

3. Push [▲] or [▼] to select "Day Mode," "Night Mode," or "Auto."

① If you push no key for about 5 seconds in the Backlight Settings window, the transceiver automatically returns to the Main screen.

Day mode

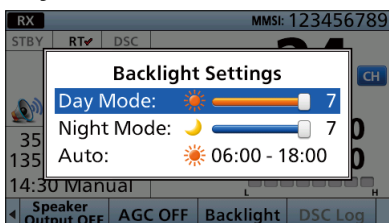

Night mode

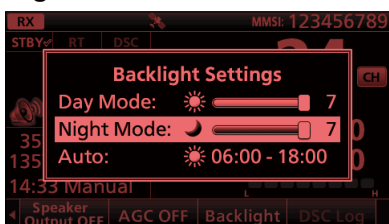

Auto

The Day mode or the Night mode is automatically selected.

4. Adjust the backlight brightness level.

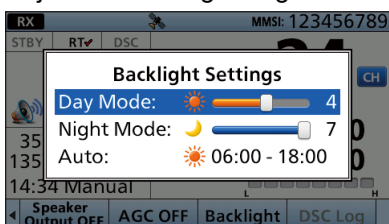



① The backlight brightness level is adjustable in 7 levels and "OFF." "OFF" is selectable only in the Day mode.

■ Instant Replay function

The transceiver has an Instant Replay function that can record the last 120 seconds of the received audio. You can playback the audio that you could not hear.

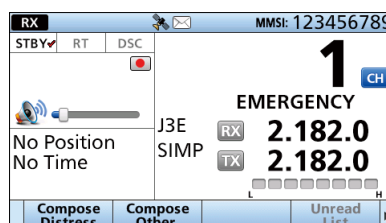
- Starts recording automatically when the signal is received.



-  is displayed when recording the received audio.
- Stops recording 3 seconds after the signal disappears or when the channel is changed.
-  is displayed when recording is stopped.
- The recorded audio is erased when the transceiver is turned OFF.



◇ Playback the recorded voice

You can set the play start point in the "Play Time" setting before playing. (p. 60)

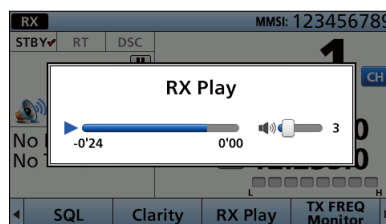
1. Push [◀] or [▶] until **RX Play** is displayed in the Software Key area.
2. Push **RX Play**  to play the recorded audio.
 - The recorded audio automatically starts playing.
 - The play window is displayed as shown below.



TIP:

- To stop playing the recorded audio, push [CH/GRP].
 - ① Push [CH/GRP] again to restart play.
- Rotate [CH/GRP] to adjust the play start point.
 - ① Set between -2'00 to 0'00.
- Rotate [VOL] to adjust the volume level.
 - ① Set to between 0 (Off) and 20.
-  is displayed when playing the recorded audio.
-  is displayed when playing the recorded audio is stopped.
- When the play window is displayed, recording the newly received audio is stopped.

■ Scan

The transceiver has automatic channel and frequency scan capabilities (Scan function). There are 3 types of scan functions.

- CH (Channel)
- CH Resume
- Program

◇ CH and CH Resume

The CH and CH Resume searches within a 20 channel range, such as channel 1 to channel 20, in the user channels, and searches all channels in the same bandwidth in the ITU channels and ITU FSK channels.

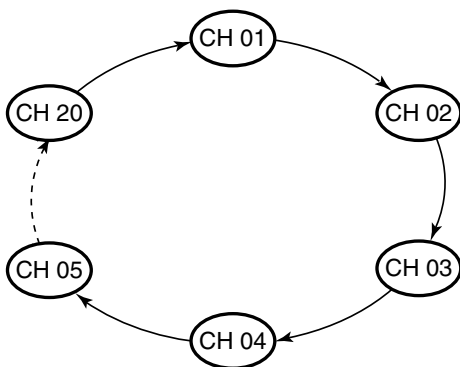

CH:

When [PTT] is pushed, the scan stops, and transmission starts on the displayed channel. Even though the squelch is open, the channels are switched at the time set in “Speed” on the Menu screen. (p. 59)

[MENU] > Radio Settings > Scan > **Speed**

CH Resume:

When [PTT] is pushed, transmission starts on the displayed channel while keeping the scan status. When 30 seconds have passed after transmission stops, scanning resumes. While the squelch is open, the channels are switched every 10 seconds.

To use the CH scan or CH Resume scan, select “CH” or “CH Resume” in “Type” on the Menu screen. (p. 59)

[MENU] > Radio Settings > Scan > **Type**

1. Rotate [GRP/CH] to select a channel group. (p. 9)
2. Push [◀] or [▶] until **Scan** is displayed in the Software Key area.
3. Push **Scan** to start a scan.
4. Push **Scan** again to stop the scan.

◇ Program

The Program scan searches the selected channel within the frequency range set by the “Start frequency” setting and the “End frequency” setting. (p. 59)

[MENU] > Radio Settings > Scan > Program Scan FREQ > **Start Frequency**

[MENU] > Radio Settings > Scan > Program Scan FREQ > **End Frequency**

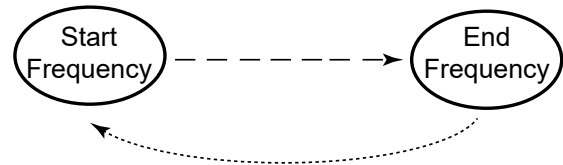

To use the Program scan, select “Program” in “Type” on the Menu screen. (p. 59)

[MENU] > Radio Settings > Scan > **Type**

1. Rotate [GRP/CH] to select a channel. (p. 9)
2. Push [◀] or [▶] until **SQL** is displayed in the Software Key area.
3. Push **SQL** to turn OFF the Squelch function.
4. Push [◀] or [▶] until **Scan** is displayed in the Software Key area.
5. Push **Scan** to start a scan.
6. Push **Scan** again to stop the scan.

Other functions

Emergency FREQ channel

Select the Distress Voice Frequency. When this channel is selected, the Voice Frequency of a DSC call can be monitored without receiving or transmitting a DSC call.

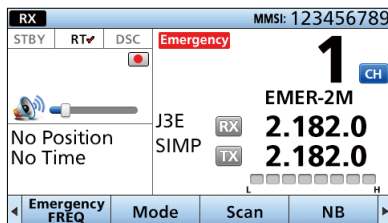

1. Push [◀] or [▶] until **Emergency FREQ** is displayed in the Software Key area.
2. Push **Emergency FREQ** .
 - The channel is changed to an Emergency FREQ channel and **Emergency** is displayed in the Channel area.
3. Rotate [CH/GRP] or push [▲] or [▼] to select a channel.

Noise Blanker function

The Noise Blanker function reduces pulse-type noises that come from engine ignitions. However, if the received strong signals are distorted, adjust the Noise Blanker level or turn OFF the function.

1. Push [◀] or [▶] until **NB** is displayed in the Software Key area.
2. Push **NB** to turn the function ON or OFF.
 - ① When the function is ON, "NB" is displayed in the Status area.

Noise Blanker Level

When the Noise Blanker function is ON, adjust the Noise Blanker level to reduce various pulse-type noises. Set to between 1 and 10.

1. Push [◀] or [▶] until **NB Level** is displayed in the Software Key area.
2. Push **NB Level** .
 - The NB level setting window is displayed.
3. Push [◀]/[▼] or [▲]/[▶] to adjust the Noise Blanker level.

Squelch function

The Squelch function mutes unwanted signals such as noise or unmodulated beat signals. This function enables quiet standby. However, if you need to receive weak signals, adjust the squelch level, or turn OFF the function.

1. Push [◀] or [▶] until **SQL** is displayed in the Software Key area.
2. Push **SQL** to turn the function ON or OFF.
 - ① When the function is ON, "SQL" is displayed in the Status area.

S-meter Squelch Level

When the Squelch function is ON, only signals stronger than this set level are received. Set to between 0 (open) and 100 (tight).

1. Push [◀] or [▶] until **S-SQL Level** is displayed in the Software Key area.
2. Push **S-SQL Level** .
 - The S-SQL level setting window is displayed.
3. Push [◀]/[▼] or [▲]/[▶] to adjust the squelch level.

RF gain Level

To receive weak signals, you can set the minimum RF (Radio Frequency) gain level needed. Set to between 0 and 9.

1. Push [◀] or [▶] until **RF Gain** is displayed in the Software Key area.
2. Push **RF Gain** .
 - The RF gain level setting window is displayed.
3. Push [◀]/[▼] or [▲]/[▶] to adjust the RF gain level.

Clarity Control function

With the Clarity Control function, you can slightly shift the receive frequency without changing the operating transmit frequency to finely tune it. When the function is ON, adjust the receive frequency. Set to between -150 Hz and +150 Hz (in 10 Hz steps).

1. Push [◀] or [▶] until **Clarity** is displayed in the Software Key area.
2. Push **Clarity** to turn the function ON.
 - **CLARITY 0** is displayed in the Channel area.
3. Push [▲] or [▼] to adjust the receive frequency.

▶ Continued on the next page.

5 OTHER FUNCTIONS AND OPERATIONS

■ Other functions



Transmit Frequency Monitor function

When selecting a duplex channel, the transmit frequency differs from the receive frequency. To prevent interference to other stations, the transmit frequency should be monitored before you transmit.

1. Push [◀] or [▶] until **TX FREQ Monitor** is displayed in the Software Key area.
2. Hold down **TX FREQ Monitor**  to monitor the transmit frequency.
 - **TX** blinks while holding down.

Speaker Output

When the Speaker Output function is ON, an internal speaker is turned ON.

1. Push [◀] or [▶] until **Speaker Output OFF** is displayed in the Software Key area.
2. Push **Speaker Output OFF**  to turn the function ON or OFF.
 - ① When the function is ON, the Software key is changed to **Speaker Output OFF**.
 - ② When the function is OFF, the Software key is changed to **Speaker Output ON** and  is displayed in the Information area.

Automatic Gain Control OFF

The Automatic Gain Control (AGC) function prevents distortion from strong signals and maintains a constant output level.

To receive weak signals, turn OFF the function.

1. Push [◀] or [▶] until **AGC OFF** is displayed in the Software Key area.
2. Push **AGC OFF**  to turn OFF the function.
 - ~~AGC~~ is displayed in the Status area.

■ Setting a temporary operating frequency

You can temporarily change the operating frequency of the selected channel. The frequency returns to the preset value after you select another channel, or turn OFF the transceiver.

1. Select a channel that is near the frequency you want to receive.
 - The RX icon lights blue.
2. Push [RX/TX] to select the RX mode.
 - The RX icon lights blue.
3. Enter a receive frequency.

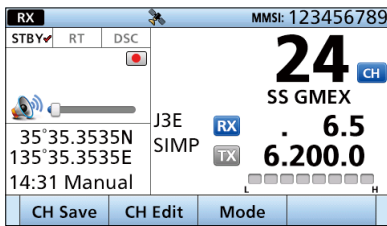

TIP:

- Select the digit using [◀] and [▶], and change the value using [▲] and [▼], or rotating [CH/GRP].
- When you select the digit using [◀] and [▶],  is displayed above the selected digit.
- You can directly enter a frequency by using the Keypad keys.

NOTE:

- If you enter a frequency that is out of the frequency range, an error beep sounds, and the channel automatically returns to the preset frequency.
- If you enter a frequency using the Keypad keys and 10 seconds have passed without pressing [ENT], the channel automatically returns to the preset frequency.
- **BE SURE** to push [ENT] after entering the frequency by using the Keypad keys.
Example: Entering 6520.0 kHz
[6] → [5] → [2] → [0] → [0] → [ENT]

4. Push [RX/TX] to select the TX mode.
 - The TX icon lights blue.



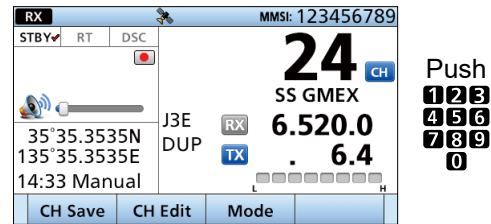

5. Enter a transmit frequency by using the Keypad keys.



① See the NOTE in step 3 to enter.

6. Push [RX/TX].

TIP:

- If you want to save the entered frequency:
 1. Push **CH Save**  after the frequency is entered.
 - “Are You Sure?” is displayed.
 2. Push **OK** .
 3. Push [RX/TX] or [CLR].
- If you want to change and save the frequency and other settings of the selected channel, push **CH Edit**  to open the Channel Edit screen. See the next page for details.
- Push **Mode**  to change the operating mode to J3E, H3E, LSB, J2B, F1B, or A1A.

■ Setting a User channel or an ITU Simplex channel

Your dealer has already preset User channels and ITU Simplex channels.

Follow the instructions as described below only when editing these channels is needed.

You can edit the following information of a User channel or an ITU Simplex channel.

- Operating frequency
- Operating mode
- Channel name

NOTE:

- If the preset channels are edited, you may not be able to communicate with other vessels.
- The following instructions are for User channel editing. However, you can edit an ITU Simplex channel in the same way.

Step 1. Entering the Channel Edit screen

1. Open the “User CH” or “ITU Simplex CH” screen.

[MENU] > Radio Settings > **User CH**

[MENU] > Radio Settings > **ITU Simplex CH**

2. Select a channel to edit.

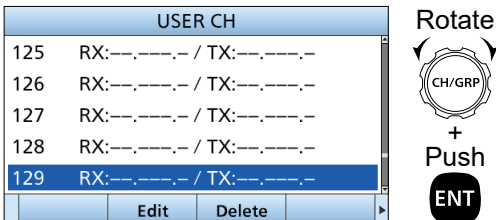

Step 2. Setting an RX and TX operating frequencies

NOTE: The RX and TX operating frequencies are the same when an ITU Simplex channel is selected.

1. Select “Frequency.”

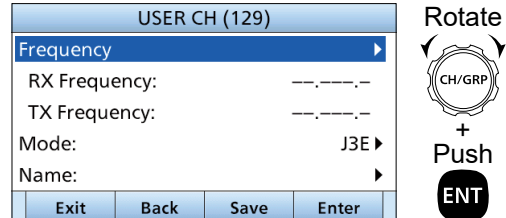

2. Enter an RX frequency, and then push **Finish** .

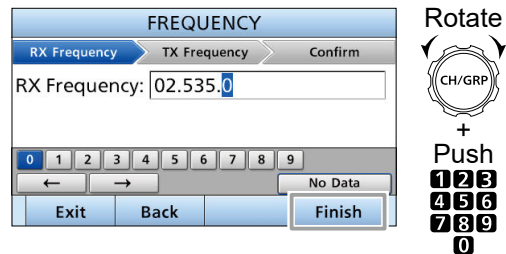

3. Enter a TX frequency, and then push **Finish** .

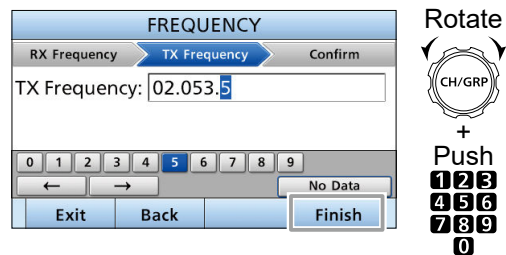

Step 3. Setting an operating mode

1. Select “Mode.”

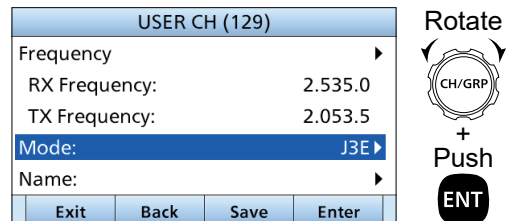

2. Select an operating mode.

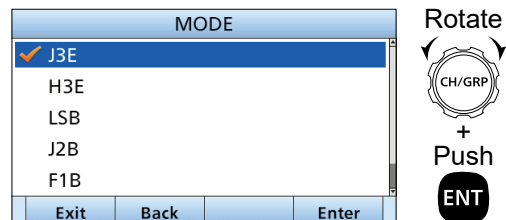

Step 4. Setting a channel name

You can set a channel name of up to 10 characters for each User channel or ITU Simplex channel. This may be helpful to indicate the frequency's use or a vessel's name.

1. Select "Name."

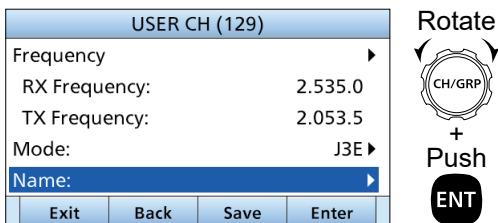

2. Enter a channel name, and then push **Finish**



3. Push **Save** .
 - "Are You Sure?" is displayed.

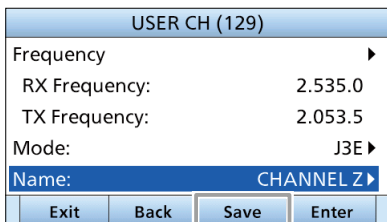

4. Push **OK** to save the edited data.

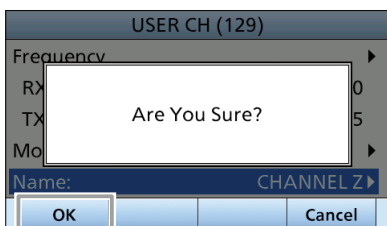

5. Push [MENU] to return to the Main screen.

Assigning a function

You can assign different Software Key functions to a key between Softkey 1 and Softkey 20. (p. 18)

You can also assign some Software Key functions to [VOL] on the remote controller and [P] on the supplied microphone.

Assigning a Software Key function to a Software Key

1. Open "Softkey Assignment."

[MENU] > Configuration > Key Assignment > **Softkey Assignment**

2. Select a Softkey.

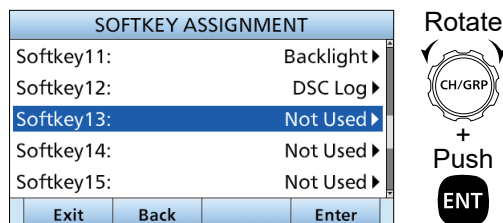

3. Select a Software Key function.

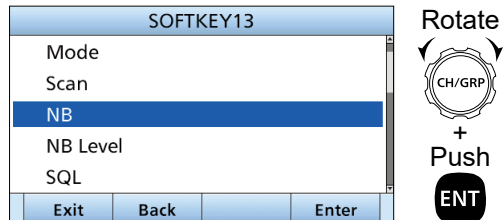

- The selected Software Key function is assigned to the Softkey.

4. Push [MENU] or **Exit** to return to the Main screen.

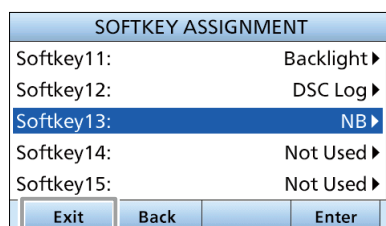

TIP: You can confirm the selected function is assigned to the Software Key after returning to the Main screen.

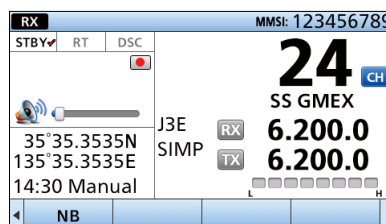

5 OTHER FUNCTIONS AND OPERATIONS

■ Assigning a function

◇ Assigning a Software Key function to [VOL]

1. Open "Volume Dial Assignment."

[MENU] > Configuration > Key Assignment > **Volume Dial Assignment**

2. Select a place.

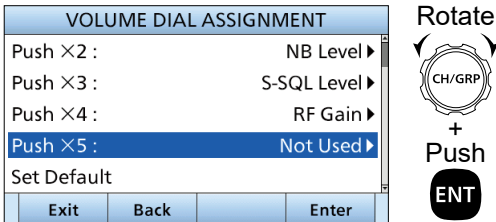

3. Select a Software Key function.

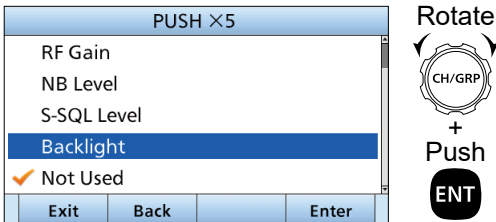

- The selected Software Key function is assigned to [VOL].

4. Push [MENU] or **Exit**  to return to the Main screen.

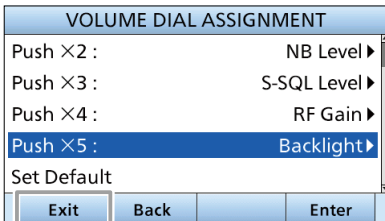

TIP: You can confirm the selected function is assigned to the Volume Dial after returning to the Main screen. (Example: When [VOL] is pushed 5 times, the Backlight Settings window is displayed.)

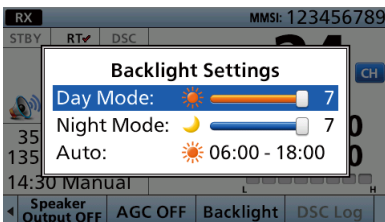

◇ Assigning a Software Key function to [P] on the supplied microphone

1. Open "P Key Assignment."

[MENU] > Configuration > Key Assignment > **P Key Assignment**

2. Select a Software Key function.

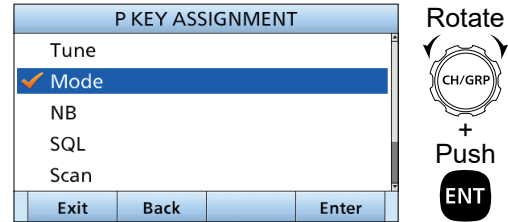

- The selected Software Key function is assigned to [P].

3. Push [MENU] or **Exit**  to return to the Main screen.

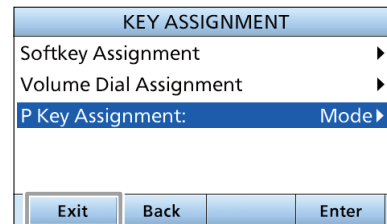

TIP: You can confirm the selected function is assigned to [P] after returning to the Main screen.

About DSC

Digital Selective Calling (DSC) is an automated digital communication system defined by ITU-R M.493, and is also part of the Global Maritime Distress and Safety System (GMDSS). The international VHF and MF/HF marine transceivers installed in this system can transmit and receive Distress, Urgency, Safety, and Routine DSC calls to and from other vessels and coast stations. If your vessel requires assistance, contact other vessels and the Coast Guard by sending a Distress call, which includes your MMSI code, the position and time data, and the nature of distress on an emergency frequency.

NOTE:

- To use a DSC call, entering the MMSI code is needed. See page 8 for details.
- To send your vessel's position and time data, receiving them from the supplied GPS antenna, NMEA 0183 or NMEA 2000, or manually entering is needed. See page 63 for each connector connection and page 22 for manual input details.
- The Mode setting of all DSC call is fixed to "Telephony."
- The order of priority for DSC calls is Distress, Urgency, Safety, and Routine.

DSC address ID

◇ Entering an Individual or Group ID

You can enter a total of 75 Individual IDs and 25 Group IDs, and assign names of up to 10 characters.

(Example: Entering an Individual ID)

1. Open "Individual ID."

[MENU] > DSC Settings > **Individual ID**

- "No ID" is displayed if no ID is entered.

① To entering a Group ID:

[MENU] > DSC Settings > **Group ID**

2. Push **Add** .

- The ID entry screen is displayed.

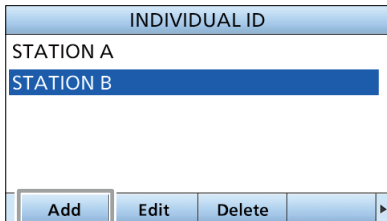

3. Select "Address."

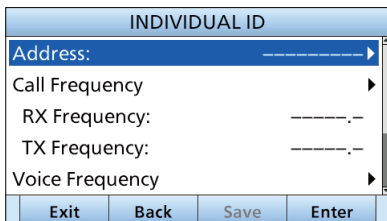

4. Enter an Individual or Group ID, and then push **Finish** .

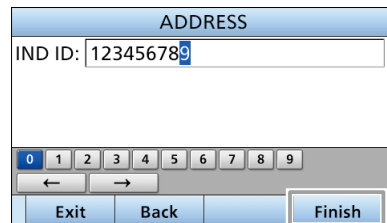

NOTE:

- For a Group ID, the first digit is fixed as "0."
- For any coast station ID, the first two digits are fixed as "00."

5. Select "Call Frequency."

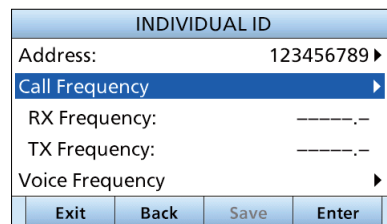

6. Enter a receive frequency, and then push **Finish** .

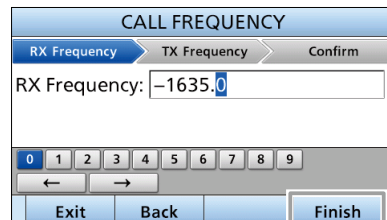

7. Enter a transmit frequency, and then push **Finish** .

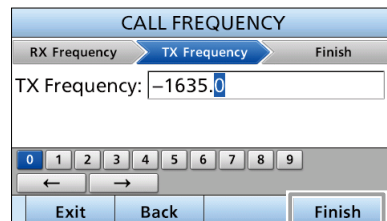

▶ Continued on the next page.

6 DSC OPERATION

■ DSC address ID

8. Select "Voice Frequency."

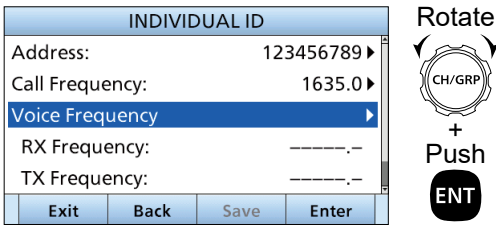

9. Enter a receive frequency, and then push **Finish**.

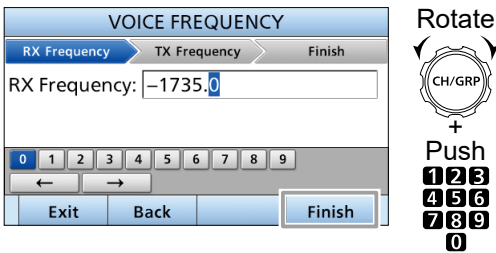

10. Enter a transmit frequency, and then push **Finish**.

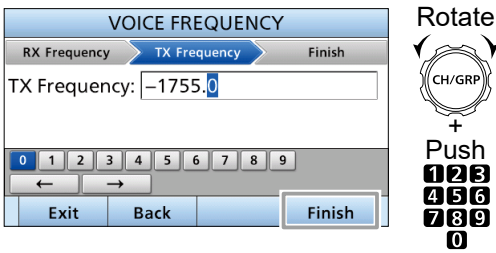

11. Select "Name."

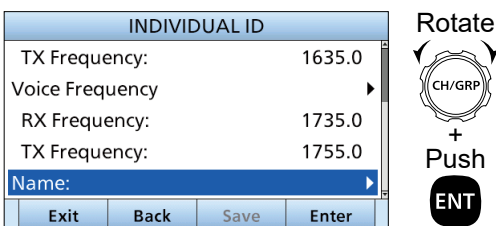

12. Enter an ID's name, and then push **Finish**.

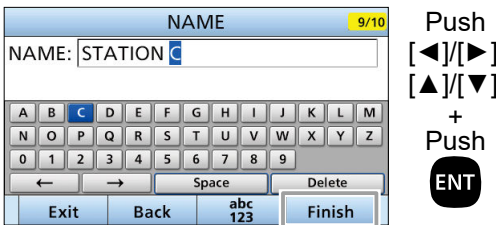

13. Push **Save**.
• "Are You Sure?" is displayed.

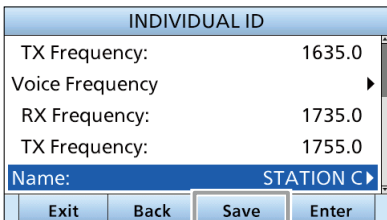

14. Push **OK**.
• The entered name is displayed.

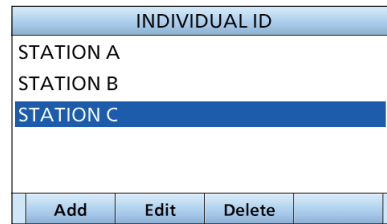
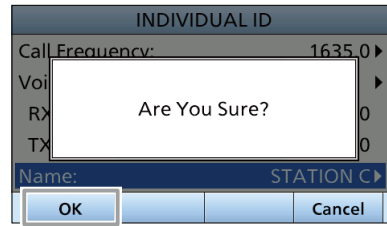

15. Push [MENU] to return to the Main screen.

TIP: You can edit the settings of the selected ID by pushing **Edit** in step 2.

◇ Delete an entered ID

(Example: Deleting an Individual ID: STATION B)

1. Open "Individual ID."

[MENU] > DSC Settings > **Individual ID**

2. Select the "STATION B," and then push **Delete**.
• "Are You Sure?" is displayed.

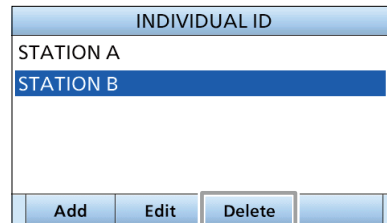

3. Push **OK**.

• The selected ID is deleted, and then returns to the previous screen.

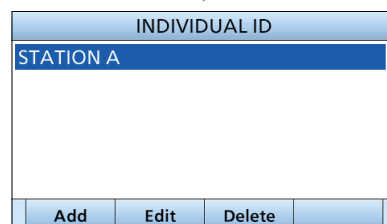
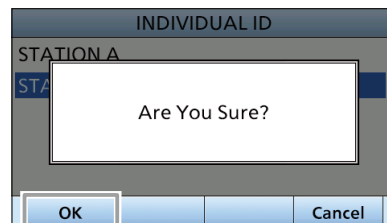

ⓘ Push **Cancel** to cancel the deletion.

■ Entering the position data and time

A Distress call should include the vessel's position, date, and time. If no GPS data is being received, manually enter the position and Universal Time Coordinated (UTC) time.

NOTE:

- Manual entry is disabled while valid GPS data is being received.
- The manually entered position and time are valid only for 23.5 hours.

1. Open "Position Input."

[MENU] > DSC Settings > **Position Input**

2. Enter the latitude, and then push **Finish** .

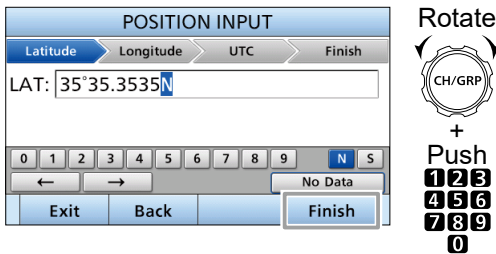

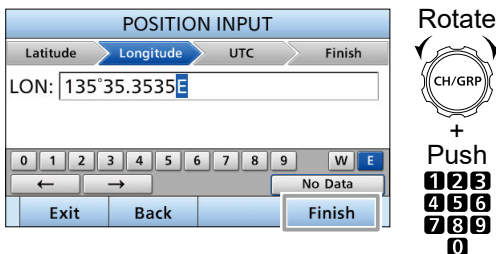

① To select 'N' (North latitude) or 'S' (South latitude), select "N" or "S" on the screen and push [ENT], or push a Keypad key when the cursor is on the 'N' or 'S.'

3. Enter the longitude, and then push **Finish** .



① To select 'W' (West longitude) or 'E' (East longitude), select "W" or "E" on the screen and push [ENT], or push a Keypad key when the cursor is on the 'W' or 'E.'

4. Enter the UTC, and then push **Finish** .

- After **Finish**  is pushed, the entered position data and time is set, and the DSC Settings screen is displayed.

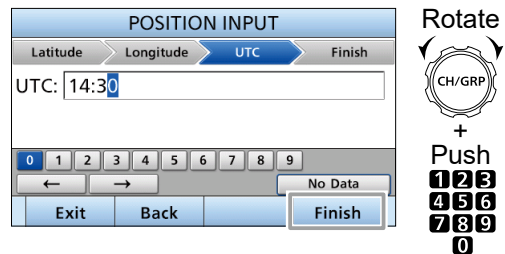

5. Push [MENU] or **Exit**  to return to the Main screen.

- The entered position data and time and "Manual" are displayed in the Position data and Time area.

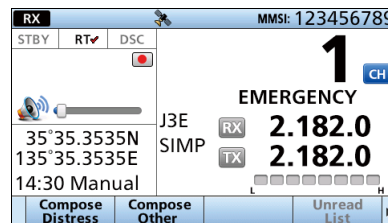

■ DSC Task mode

After sending or receiving a DSC call, the transceiver enters the DSC Task mode. The transceiver can hold only 1 task.

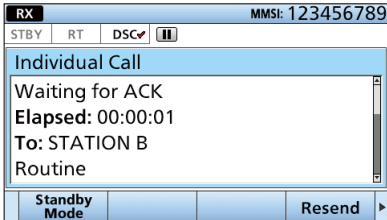

(Example: After transmitting an Individual call)

You can resend the call or send an Acknowledgment to the caller station in the DSC Task mode.

NOTE: The Task mode has the Time-out Timer (TOT) function. After a certain period of time has passed without any operation on a task, the transceiver automatically exits the Task mode and returns to the Main screen. When the TOT function is activated, an alarm sounds, and a countdown message is displayed for 10 seconds. No alarm sounds and no countdown message is displayed before the Radio Telephone TOT is activated. You can set the TOT function in the Inactivity Timer menu. (p. 56)

◇ Software Key functions

While in the DSC Task mode, the following functions are displayed first.

Function	Description
Standby mode	Push to delete the task and return to the Main screen.
Resend	Push to resend the call.



The following functions may be displayed, depending on the call type.

Function	Description
Cancel	Push to send a Cancel call.
Pause	Push to pause the 'Call Repeat' mode, or pause the countdown.
Resume	Push to resume the countdown.
Finish	Push to exit the Distress Cancel Statement screen.
History	Push to display the Distress Call History screen.
ACK/ACK (able)	Push to send an Acknowledgment without any changes.
ACK (Unable)	Push to send an Acknowledgment, but you cannot make a call.
ACK (New CH)	Send an Acknowledgment. You can specify the Voice Communication frequency.

◇ Unread List

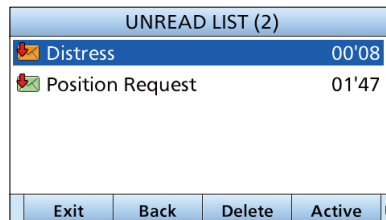
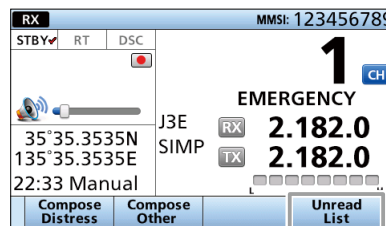
If the transceiver has unread DSC calls, you can display the Unread List screen by pushing **Unread List** .



- ① Push **Active**  to enter the Task mode.
- ① Push **Info**  to display the detail of the selected task.

■ Sending DSC calls (Distress)

A Distress call should be sent when, in the opinion of the captain, the vessel or a person is in distress and requires immediate assistance.

NEVER MAKE A DISTRESS CALL IF YOUR VESSEL OR A PERSON IS NOT IN AN EMERGENCY. A DISTRESS CALL SHOULD BE MADE ONLY WHEN IMMEDIATE HELP IS NEEDED.

◇ Simple call

1. Confirm that no Distress call is being received.
2. While lifting the key cover, hold down [DISTRESS] for 3 seconds until you hear 3 short countdown beeps and 1 long beep sound.

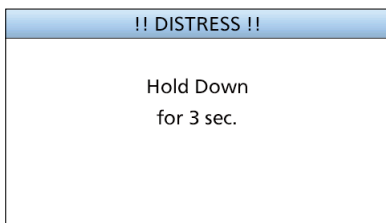

- The backlight blinks.

① All Emergency Frequencies are automatically selected to send a Distress call.

3. After sending, wait for an Acknowledgment call.

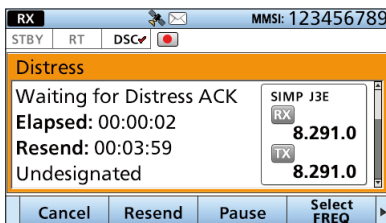

- "Waiting for ACK" is displayed.
- The Distress call is automatically sent every 3.5 to 4.5 minutes until an Acknowledgment is received, or a Distress Cancel call is sent.

4. When you receive an Acknowledgment, an alarm sounds. Push **Alarm Off** to turn OFF the alarm.

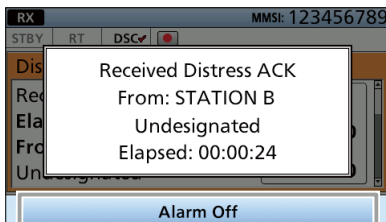

5. Push **Close Call RCVD Window**.

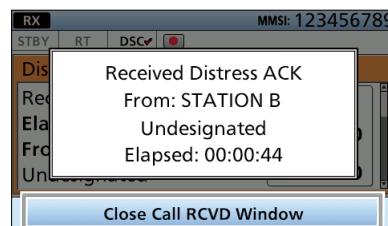

6. Hold down [PTT], and then explain your situation.
7. After you have finished your explanation, push **Standby Mode**, and then **OK** to return to the Main screen.

TIP: A default Distress alert contains:

- Nature of distress: Undesignated distress
- Position information: The latest GPS or manually input position held for 23.5 hours or until you turn OFF the transceiver.

6 DSC OPERATION

■ Sending DSC calls (Distress)

◇ Regular call

Select the nature of the Distress call to include in the Regular Distress call.

1. Push **Compose Distress** .
 - The “COMPOSE DISTRESS” screen is displayed.
 - ① To display the screen from the Menu screen:

[MENU] > **Compose Distress**

Step 1. Setting a “Nature of Distress”

1. Select “Nature of Distress.”

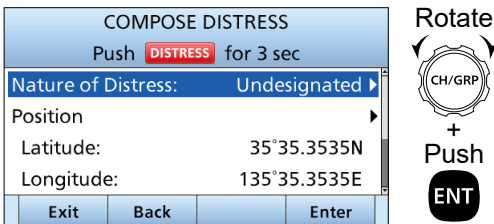

2. Select the nature of the Distress. (Example: Fire, Explosion)
 - The setting is saved and returns to the previous screen.

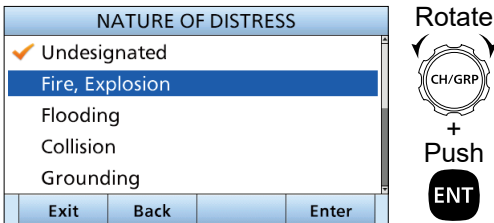

Step 2. Entering a “Position”

NOTE: When your position data and time are valid, you can skip this step and go to step 3.

1. Select “Position.”

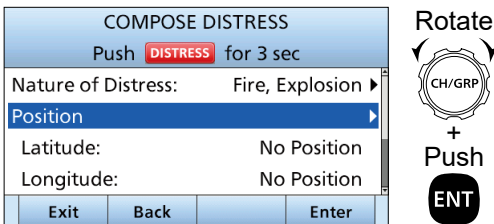

2. Enter your position data and time.
 - See page 22 for entering details.

Step 3. Setting a communication frequency

1. Select “Attempt.”

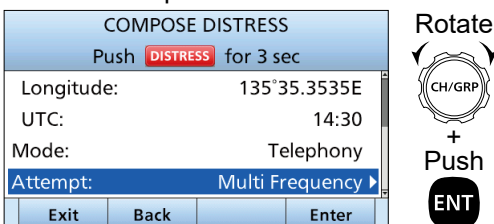

2. Select an option. (Example: Multi Frequency)
 - The setting is saved and returns to the previous screen.

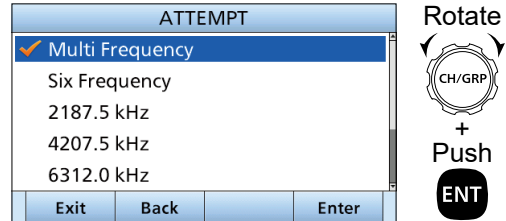

Step 4. Sending

1. While lifting the key cover, hold down [DISTRESS] for 3 seconds until you hear 3 short countdown beeps and 1 long beep sound.
 - The backlight blinks.

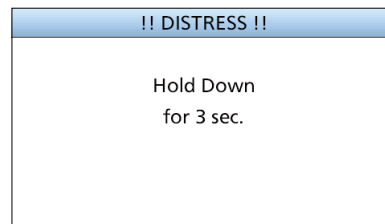

2. After sending, wait for an Acknowledgment call.
 - “Waiting for Distress ACK” is displayed.
 - The Distress call is automatically sent every 3.5 to 4.5 minutes until an Acknowledgment is received, or a Distress Cancel call is sent.

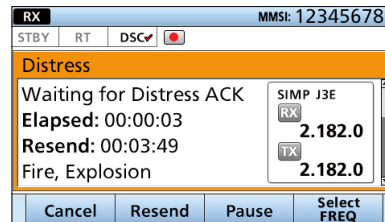

3. When you receive an Acknowledgment, an alarm sounds. Push **Alarm Off** to turn OFF the alarm.



4. Push **Close Call RCVD Window** .

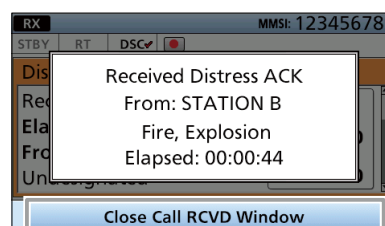

5. Hold down [PTT], and then explain your situation.
6. After you have finished your explanation, push **Standby Mode** , and then **OK** to return to the Main screen.

◇ Resending a Distress call

While waiting for an Acknowledgment, you can resend the call (Repeat call).

- When the “Waiting for ACK” screen is displayed, push **Resend** .
 - The “RESEND DISTRESS” screen is displayed.

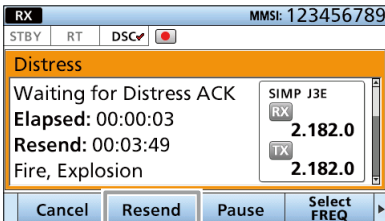

① See page 23 for details of the Software Key functions in the DSC Task mode.

- Select options of “Position” and “Attempt” again if needed.
- While lifting the key cover, hold down [DISTRESS] for 3 seconds until you hear 3 short countdown beeps and 1 long beep sound.
 - The backlight blinks.

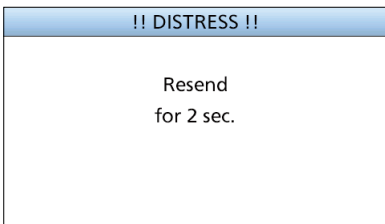

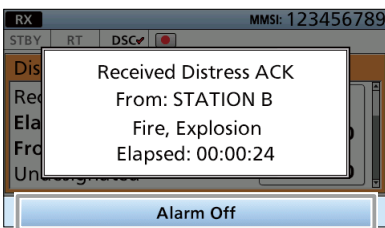

- When you receive an Acknowledgment, an alarm sounds. Push **Alarm Off**  to turn OFF the alarm.

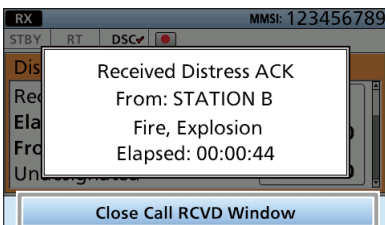

- Push **Close Call RCVD Window** .





- Hold down [PTT], and then explain your situation.
- After you have finished your explanation, push **Standby Mode** , and then **OK**  to return to the Main screen.

TIP:

Transmitting:

- A default Distress alert contains:
 - Nature of distress: Undesignated distress
 - Position information: The latest GPS or manually input position held for 23.5 hours or until you turn OFF the transceiver.
- While holding down [DISTRESS], count down beeps sound, and both the key and display backlights blink.
- All Emergency Frequencies are automatically selected to send a Distress call. You can select one or more Emergency Frequencies to send a Regular Distress call.

Waiting for an Acknowledgment:

- The Distress call is automatically transmitted every 3.5 to 4.5 minutes until an Acknowledgment is received (Call Repeat function) or make a Distress Cancel call. (p. 27)
- To manually transmit a Distress Repeat call, push **Resend** .
- To display the transmitted Distress call information, rotate [CH/GRP], or push [▲] or [▼].
- To pause the Call Repeat function, push **Pause** . To resume it, push **Resume Countdown** .

6 DSC OPERATION

■ Sending DSC calls (Distress)

◇ Distress Cancel call

If you have accidentally made a Distress call, or made an incorrect Distress call, send a Distress Cancel call to cancel the call as soon as possible while waiting for an Acknowledgment. **BE SURE** to report the purpose of the cancellation.

While transmitting a Distress call

1. Push **Cancel** .



2. Confirm the content, and then push **Continue** .
 - The Distress cancel is sent.

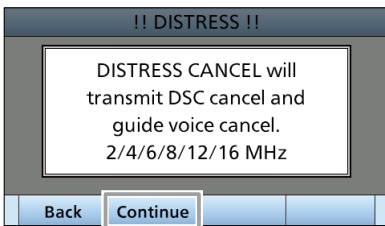

- ① The frequencies that you have to send voice cancel messages are displayed. (Example: 2/4/6/8/12/16 MHz)

- ① To cancel the Distress Cancel call, push **Back** .

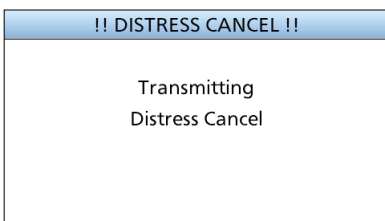
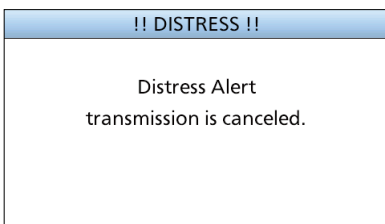

3. After sending, the following screen is displayed. Push **Select FREQ** .

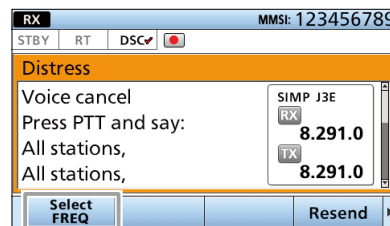

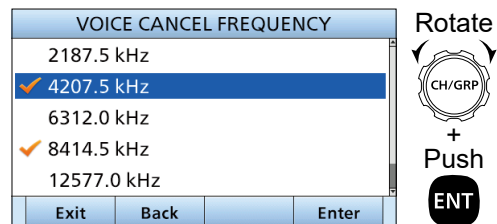

4. Select a frequency to send a voice cancel message.

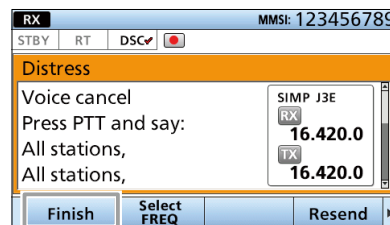

- ① The checkmark shows that the Distress call on the selected frequency is canceled by sending a voice cancel message.

5. Hold down [PTT] to report the purpose of the cancellation.
 - ① You can display the wording of the cancellation by rotating [CH/GRP], or pushing [▲] or [▼].
6. Repeat steps 3 to 5 to cancel on all frequencies.
7. After sending a voice cancel message on all frequencies, **Finish** is displayed. Push **Finish** .



8. Push **Standby Mode** , and then **OK**  to return to the Main screen.

While waiting for Distress ACK

1. When “Waiting for Distress ACK” is displayed, push **Cancel** .

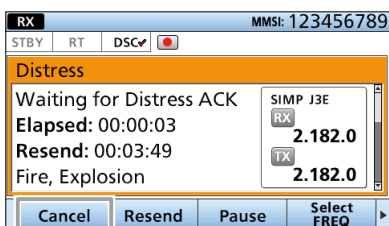

- ① See page 23 for details of the Software Key functions in the DSC Task mode.
2. Push **Continue**  to send the Distress Cancel call.
 - The Distress Cancel call is sent.

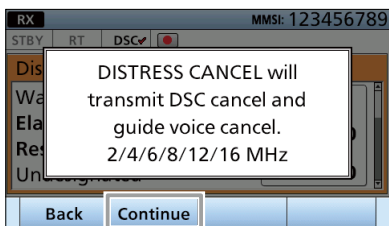

- ① The frequencies that you have to send voice cancel messages are displayed. (Example: 2/4/6/8/12/16 MHz)
 - ① To cancel the Distress Cancel call, push **Back** .

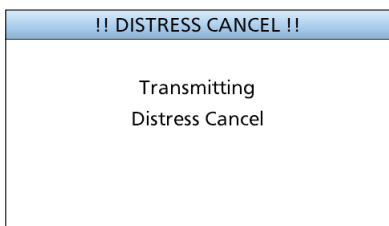

3. After sending, the following screen is displayed. Push **Select FREQ** .

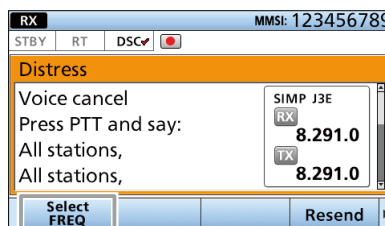

4. Select a frequency to send a voice cancel message.

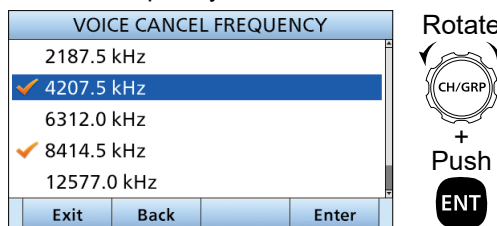

- ① The checkmark shows that the Distress call on the selected frequency is canceled by sending a voice cancel message.
5. Hold down [PTT] to report the purpose of the cancellation.
 - ① You can display the wording of the cancellation by rotating [CH/GRP], or pushing [▲] or [▼].
6. Repeat steps 3 to 5 to cancel on all frequencies.
7. After sending a voice cancel message on all frequencies, **Finish** is displayed. Push **Finish** .

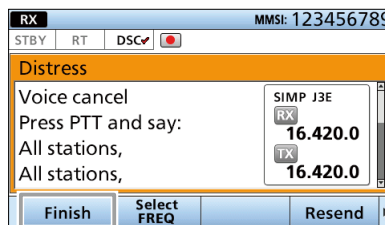

8. Push **Standby Mode** , and then **OK**  to return to the Main screen.

■ Sending DSC calls (other)

◇ Sending an Individual call

An Individual call enables you to send a DSC signal to only a specific station.

You can communicate normally after receiving the Acknowledgment “ACK (able).”

① You can send an Individual call to a pre-entered Individual ID or manually enter the target station ID before sending. (p. 20)

1. Push **Compose Other** .
 - The “COMPOSE NON-DISTRESS” screen is displayed.
 - ① To display the screen from the Menu screen:

[MENU] > **Compose Non-Distress**

2. Select “Address.”

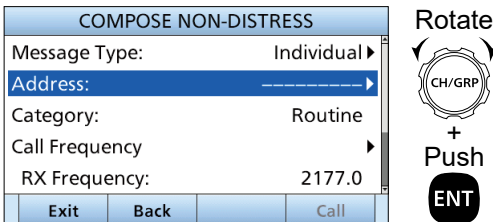

3. Select an Individual ID or “Manual Input.”

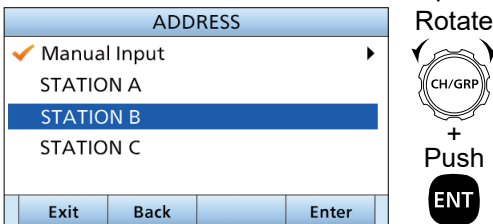

NOTE: When “Manual Input” is selected in this step, push the Keypad keys to manually enter the target station ID.

4. Select “Call Frequency.”

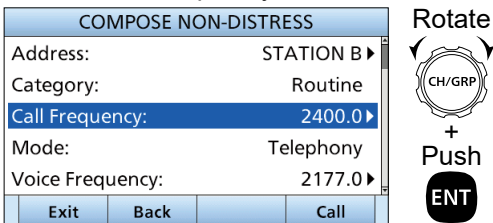

5. Select a call frequency or “Manual Input.”

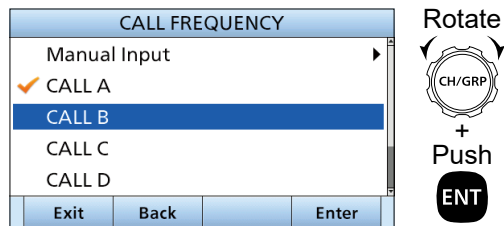

NOTE: When “Manual Input” is selected in this step, push the Keypad keys to manually enter a call frequency.

6. Select “Voice Frequency.”

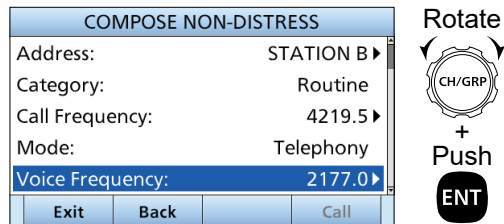

7. Select a voice frequency or “Manual Input.”

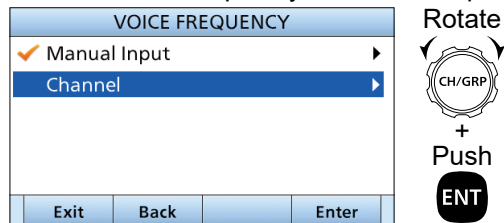

NOTE: When “Manual Input” is selected in this step, push the Keypad keys to manually enter a voice frequency.

8. Push **Call**  to send an Individual call.
 - “Transmitting Individual Call” is displayed, and then “Waiting for ACK” is displayed.

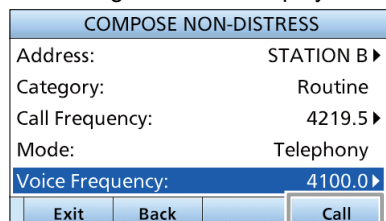

① See page 23 for details of the Software Key functions in the DSC Task mode.

9. When you receive an Acknowledgment "Able to comply":
 - An alarm sounds.
 - The following screen is displayed.
 Push **Alarm Off** to turn OFF the alarm.

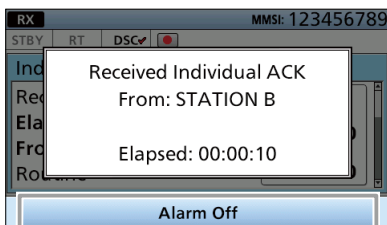

10. Push **Close Call RCVD Window**.

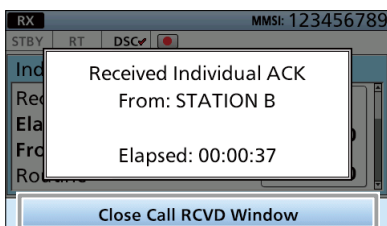

11. Hold down [PTT], and then communicate normally.
12. After you have finished your call, push **Standby Mode**, and then **OK** to return to the Main screen.

TIP: If you received an Acknowledgment "Unable to comply":

1. Push **Alarm Off** to turn OFF the alarm.
 - The Acknowledge information is displayed.
2. Push **Standby Mode**, and then **OK** to return to the Main screen.

◇ Sending an Individual Acknowledgment

When you have received an Individual call (p. 41), send an Acknowledgment to the calling station. When "Manual" is selected in "Individual ACK" (p. 49), you can select an appropriate Acknowledgment type.

1. While an Individual call is being received, push **Alarm Off** to turn OFF the alarm.

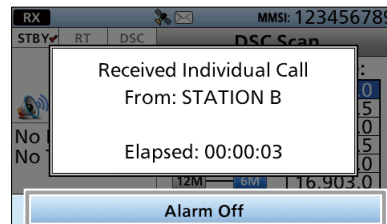

2. Push **Accept**.
 - The received call's information is displayed.

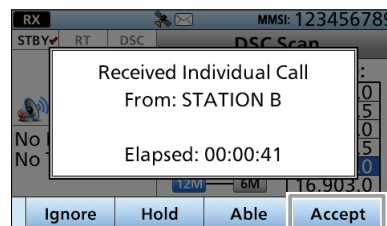

- ① If you want to immediately send an Acknowledgment "Able to comply," push **Able**.
 - ① If you cannot communicate and want to return to the Main screen, push **Ignore**.
 - ① If you want to put the task on hold, push **Hold**.
3. Push a key to select an Acknowledgment option.

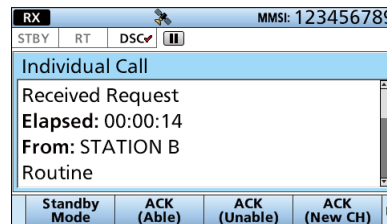

- The Call Contents screen is displayed.

TIP:

- **ACK (Able)** (Able to comply): Sends an Acknowledgment without any changes.
- **ACK (Unable)** (Unable to comply): Sends an Acknowledgment but cannot communicate.
- **ACK (New CH)** (Propose new channel): Able to communicate but propose another voice frequency. Enter the frequency in "Voice Frequency" in the next step.

► Continued on the next page.

6 DSC OPERATION

■ Sending DSC calls (other)

◇ Sending an Individual Acknowledgment (Continued)

4. Confirm the contents.

COMPOSE NON-DISTRESS		
Message Type:	Individual ACK	
Address:	STATION B	
Comply:	Able to Comply	
Category:	Routine	
Call Frequency:	16903.0	
Exit	Back	Call

Rotate

5. Push **Call** to send an Individual Acknowledgment.

- “Transmitting Individual ACK” is displayed, and then “Individual Call” is displayed.

COMPOSE NON-DISTRESS		
Message Type:	Individual ACK	
Address:	STATION B	
Comply:	Able to Comply	
Category:	Routine	
Call Frequency:	16903.0	
Exit	Back	Call

① See page 23 for details of the Software Key functions in the DSC Task mode.

6. Hold down [PTT] to talk.

7. Push **Standby Mode** , and then **OK** to return to the Main screen.

TIP: When “Individual ACK” is set to “Auto (Able)” or “Auto (Unable),” the transceiver automatically transmits an Individual Acknowledgment. (p. 49)

◇ Sending a Group call

A Group call enables you to send a DSC call to only a specific group.

① You can send a Group call to a pre-entered Group ID or manually enter the target group before sending. (p. 20)



1. Push **Compose Other** .

- The “COMPOSE NON-DISTRESS” screen is displayed.
- ① To display the screen from the Menu screen:

[MENU] > **Compose Non-Distress**



2. Select “Message Type.”

COMPOSE NON-DISTRESS		
Message Type:	Individual ▶	
Address:	-----▶	
Category:	Routine ▶	
Call Frequency:	▶	
RX Frequency:	2177.0	
Exit	Back	Call

Rotate

 +
 Push

3. Select “Group.”



MESSAGE TYPE		
✓ Individual		
Group		
Geographic Area		
Test		
Exit	Back	Enter

Rotate

 +
 Push

① “Category” is fixed to “Routine.”



4. Select “Address.”

COMPOSE NON-DISTRESS		
Message Type:	Group ▶	
Address:	0-----▶	
Category:	Routine	
Call Frequency:	▶	
RX Frequency:	2177.0	
Exit	Back	Call

Rotate

 +
 Push

5. Select a Group ID or “Manual Input.”

ADDRESS		
✓ Manual Input	▶	
Group 1		
Exit	Back	Enter

Rotate

 +
 Push

NOTE: When “Manual Input” is selected in this step, push the Keypad keys to manually enter the target group.

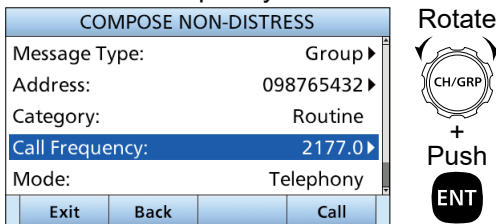
6. Select "Call Frequency."

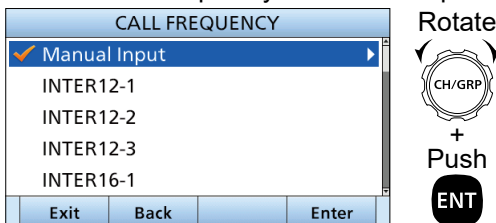

7. Select a call frequency or "Manual Input."



NOTE: When "Manual Input" is selected in this step, push the Keypad keys to manually enter a call frequency.

8. Select "Voice Frequency."

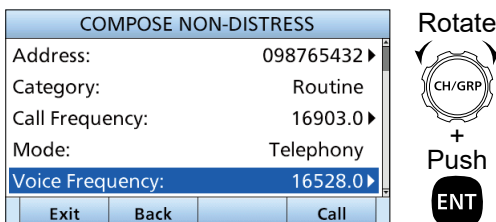

9. Select a voice frequency or "Manual Input."

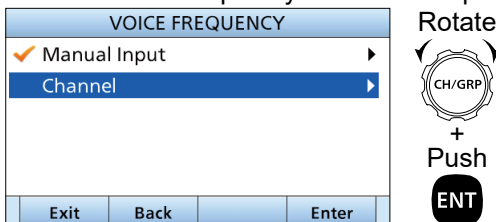

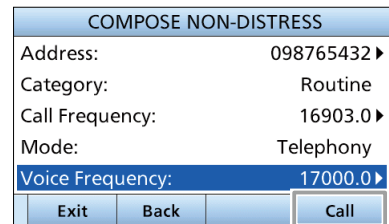

NOTE: When "Manual Input" is selected in this step, push the Keypad keys to manually enter a voice frequency.

10. Push **Call**  to send a Group call.
 • "Transmitting Group Call" is displayed, and then "Group Call" is displayed.



① See page 23 for details of the Software Key functions in the DSC Task mode.

11. Hold down [PTT] to talk.
 12. Push **Standby Mode** , and then **OK**  to return to the Main screen.

6 DSC OPERATION

■ Sending DSC calls (other)

◇ Sending a Geographical Area call

Send a Geographical Area call when it is necessary to send an urgent or safety message announcement to the vessels in a particular area.

1. Push **Compose Other** .
 - The “COMPOSE NON-DISTRESS” screen is displayed.
 - ① To display the screen from the Menu screen:

[MENU] > **Compose Non-Distress**

2. Select “Message Type.”

COMPOSE NON-DISTRESS	
Message Type:	Individual ▶
Address:	-----▶
Category:	Routine ▶
Call Frequency	▶
RX Frequency:	2177.0
Exit	Back
	Call



3. Select “Geographic Area.”

MESSAGE TYPE	
Individual	
Group	
Geographic Area	
Test	
Exit	Back
	Enter



4. Select “Area.”

COMPOSE NON-DISTRESS	
Message Type:	Geographic Area ▶
Area:	Circle ▶
Latitude:	---°---N
Longitude:	---°---E
Radius:	500 nm
Exit	Back
	Call



5. Select “Circle” or “Quadrant.”

AREA	
Circle	▶
Quadrant	▶
Exit	Back
	Enter





- Circle: See the following steps.
- Quadrant: See the next page.

When “Circle” is selected:

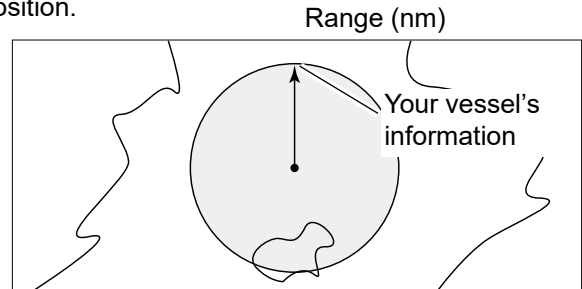
You can send a Geographical Area call within the area covered by a set nautical mile radius from your position.





1. Enter the latitude of your position, and then push **Finish** .

CIRCLE			
Latitude	Longitude	Radius	Finish
	LAT: 35°35N		
0	1	2	3
4	5	6	7
8	9	N	S
←	→	Exit	Back
			Finish



- ① Displays your vessel's position data as the default.
- ① To select 'N' (North latitude) or 'S' (South latitude), select 'N' or 'S' on the screen and push [ENT], or push a Keypad key when the cursor is on the 'N' or 'S.'

2. Enter the longitude of your position, and then push **Finish** .

CIRCLE			
Latitude	Longitude	Radius	Finish
	LON: 135°35E		
0	1	2	3
4	5	6	7
8	9	W	E
←	→	Exit	Back
			Finish



- ① Displays your vessel's position data as the default.
- ① To select 'W' (West longitude) or 'E' (East longitude), select "W" or "E" on the screen and push [ENT], or push a Keypad key when the cursor is on the 'W' or 'E.'

3. Enter the radius of the Geographical Area call area, and then push **Finish** .

CIRCLE			
Latitude	Longitude	Radius	Finish
		Radius: -500 nm	
		LAT: 35°35N	
		LON: 135°35E	
0	1	2	3
4	5	6	7
8	9		
←	→	Exit	Back
			Finish



4. Go to step 6 on the next page.

When “Quadrant” is selected:

You can send a Geographical Area call within the square as shown below. Your vessel’s position is in the upper left corner of the square.

● Example

Latitude: 20°N Height: 10°
Longitude: 100°E Width: 20°

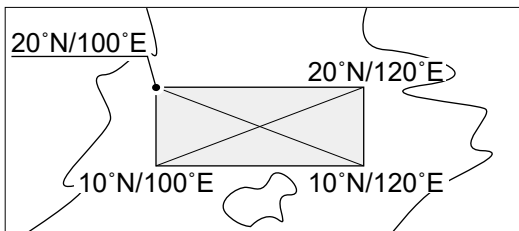

1. Enter the latitude of your position, and then push **Finish**

- ① Displays your vessel’s position data as the default.
- ① To select ‘N’ (North latitude) or ‘S’ (South latitude), select “N” or “S” on the screen and push [ENT], or push a Keypad key when the cursor is on the ‘N’ or ‘S.’

2. Enter the longitude of your position, and then push **Finish**

- ① Displays your vessel’s position data as the default.
- ① To select ‘W’ (West longitude) or ‘E’ (East longitude), select “W” or “E” on the screen and push [ENT], or push a Keypad key when the cursor is on the ‘W’ or ‘E.’

3. Enter the height of the Geographical Area call area, and then push **Finish**

4. Enter the width of the Geographical Area call area, and then push **Finish**

5. Go to step 6, as shown below.

6. Select “Category.”

7. Select an option.

8. Select “Call Frequency.”

9. Select a call frequency.

► Continued on the next page.

6 DSC OPERATION

■ Sending DSC calls (other)

◇ Sending a Geographical Area call (Continued)

10. Select "Voice Frequency."

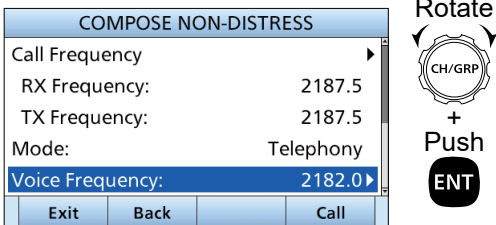

11. Select a voice frequency or "Manual Input."

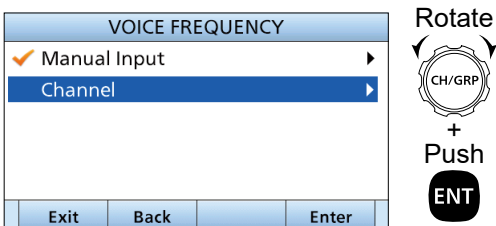

NOTE: When "Manual Input" is selected in this step, push the Keypad keys to manually enter a voice frequency.

12. Push **Call** to send a Geographical Area call.

- "Transmitting Geographical Call" is displayed, and then "Geographical Call" is displayed.

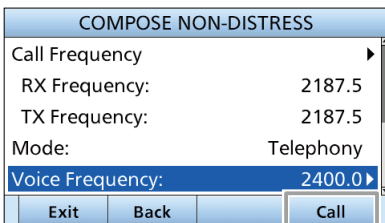

- ① See page 23 for details of the Software Key functions in the DSC Task mode.

13. Hold down [PTT] to talk.

14. Push **Standby Mode** , and then **OK** to return to the Main screen.

◇ Sending a Position Request Acknowledgment

When you have received a Position Request call, send an Acknowledgment to the calling station. When "Position ACK" is set to "Manual" (p. 49), do the following steps to send an Acknowledgment.

1. While a Position Request call is being received, push **Alarm Off** to turn OFF the alarm.

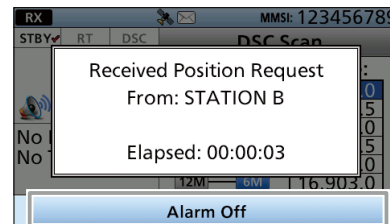



2. Push **Accept** .

- The received call's information is displayed.



- ① If you want to immediately send an Acknowledgment "Able to comply," push **Able** .

- ① If you want to immediately send an Acknowledgment "Unable to comply," push **Unable** .

- ① If you cannot send an Acknowledgment and want to return to the Main screen, push **Ignore** .

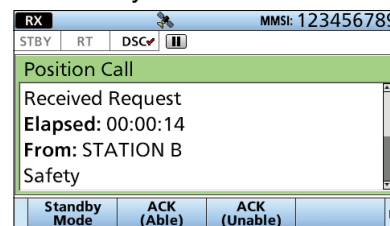

- ① If you want to put the task on hold, push **Hold** .

3. Push a key to select an Acknowledgment option.



- The Call Contents screen is displayed.

TIP:

- **ACK (Able)**  (Able to comply): Sends an Acknowledgment with the position and time data.
- **ACK (Unable)**  (Unable to comply): Sends an Acknowledgment with no position and time data.

4. Confirm the contents.

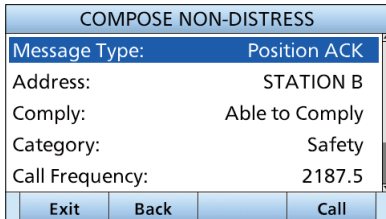

① If the displayed data is invalid, enter the position and time data (p. 22)

5. Push **Call**  to send a Position Request Acknowledgment.

- Your position and time are transmitted.

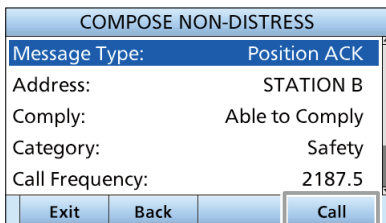

① See page 23 for details of the Software Key functions in the DSC Task mode.

6. Push **Standby Mode** , and then **OK**  to return to the Main screen.

TIP: When "Position ACK" is set to "Auto (Able)," the transceiver automatically transmits a Position Request Acknowledgment. (p. 49)

◇ Sending a Test call

You should avoid sending Test calls on the exclusive DSC Distress channels and the safety calling channels. If you cannot avoid testing on a Distress or safety channel, you should indicate that these are test calls. Usually, the Test call would require no further calls between the two stations involved.

① You can send a Test call to a pre-entered Individual ID or manually enter the target station ID before sending. (p. 20)

1. Push **Compose Other** .

- The "COMPOSE NON-DISTRESS" screen is displayed.
- ① To display the screen from the Menu screen:

[MENU] > **Compose Non-Distress**

2. Select "Message Type."

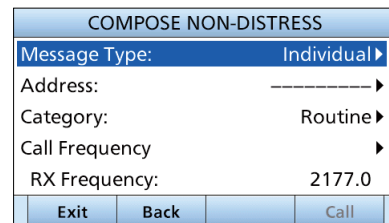

3. Select "Test."

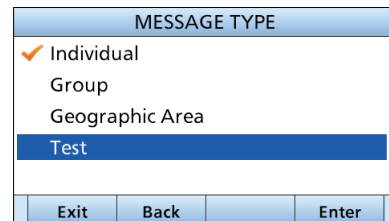

4. Select "Address."

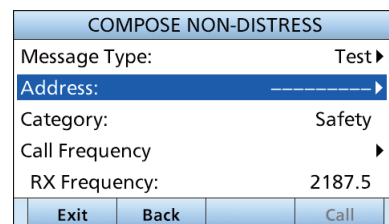

5. Select an Individual ID or "Manual Input."

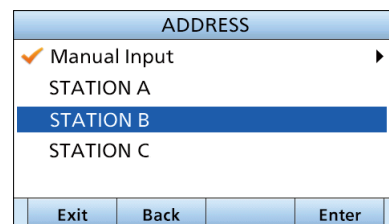

NOTE: When "Manual Input" is selected in this step, push the Keypad keys to manually enter the target station ID.

6 DSC OPERATION

■ Sending DSC calls (other)

◇ Sending a Test call (Continued)

6. Select "Call Frequency."

COMPOSE NON-DISTRESS		
Message Type:	Test ▶	
Address:	STATION B ▶	
Category:	Safety	
Call Frequency:	2187.5 ▶	
Exit	Back	Call

Rotate



+ Push



7. Select a call frequency.

CALL FREQUENCY		
✓ 2187.5 kHz		
4207.5 kHz		
6312.0 kHz		
8414.5 kHz		
12577.0 kHz		
Exit	Back	Enter

Rotate



+ Push



8. Push **Call** to send a Test call.

- "Transmitting Test Call" is displayed, and then "Test Call" is displayed.

COMPOSE NON-DISTRESS		
Message Type:	Test ▶	
Address:	STATION B ▶	
Category:	Safety	
Call Frequency:	4207.5 ▶	
Exit	Back	Call

① See page 23 for details of the Software Key functions in the DSC Task mode.

9. Push **Standby Mode**, and then **OK** to return to the Main screen.

◇ Sending a Test call Acknowledgment

When you have received a Test call (p. 45), send an Acknowledgment to the calling station. When "Test ACK" is set to "Manual" (p. 49), do the following steps to send an Acknowledgment.

1. While a Test call is being received, push **Alarm Off** to turn OFF the alarm.

DSC Scan	
Received Test Call	
From: STATION B	
Elapsed: 00:00:02	
Alarm Off	

2. Push **Accept**.

- The received call's information is displayed.

DSC Scan			
Received Test Call			
From: STATION B			
Elapsed: 00:00:30			
Ignore	Hold	Able	Accept

① If you want to immediately send an Acknowledgment

"Able to comply," push **Able**.

① If you cannot communicate and want to return to the Main screen, push **Ignore**.

① If you want to put the task on hold, push **Hold**.

3. Push **ACK**.

- The Call Contents screen is displayed.

Test Call	
Received Request	
Elapsed: 00:00:56	
From: STATION B	
Safety	
Standby Mode	ACK

4. Confirm the contents.

COMPOSE NON-DISTRESS		
Message Type:	Test ACK	
Address:	STATION B	
Category:	Safety	
Call Frequency:	2187.5	
Exit	Back	Call

Rotate



5. Push **Call** to send a Test Acknowledgment.

6. Push **Standby Mode**, and then **OK** to return to the Main screen.

TIP: When "Test ACK" is set to "Auto," the transceiver automatically transmits a Test Acknowledgment. (p. 49)

■ Receiving DSC calls (Distress)

The transceiver receives Distress calls, Distress Acknowledgments, Distress Cancel calls, Distress Relay calls, and Distress Relay Acknowledgments. When you receive a call, an Emergency Alarm sounds.

NOTE:  continuously blinks while the transceiver has a DSC call or an unread DSC message in the Received Call Log. (p. 46)

◇ Receiving a Distress call

IMPORTANT!

Distress call reception should stop after one sequence because the coast station should send back an Acknowledgment to the vessel. If the Distress call continues, even after the coast station sends back an Acknowledgment, the vessel in distress may not have received it.

When a Distress call is received:

- The emergency alarm sounds until you turn it OFF.
- “Received Distress” is displayed.

1. Push **Alarm Off**  to turn OFF the alarm.





① When “Accept after 10 sec.” or “Ignore after 10 sec.” is selected in the CH Auto Switch setting, the countdown is displayed on the bottom of the window. (p. 50)

After 10 seconds have passed since **Alarm Off**  was pushed, the screen will move to the DSC Task screen or return to the Main screen.

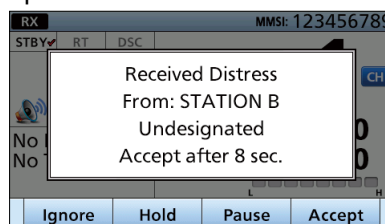
2. Push the Software Key below the intended operation.



Ignore : Ignores the call and returns to the Main screen.

Hold : Puts the RX task on hold and returns to the Main screen.



Pause : Pauses the countdown.

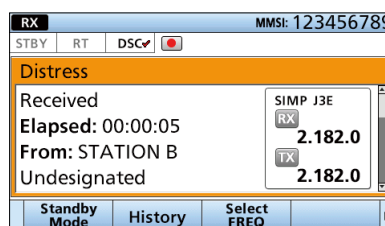

Accept : Enters the DSC Task mode immediately.



- One of the Emergency Frequencies is automatically selected. Monitor it because a coast station may require assistance.
- Rotate [CH/GRP] to confirm the call contents.

① See page 23 for details of the Software Key functions in the DSC Task mode.

3. Push **Standby Mode** , and then **OK**  to return to the Main screen.

TIP: When **Pause**  is pushed in step 2, the countdown will be paused. Push **Resume**  to resume the countdown.

6 DSC OPERATION

■ Receiving DSC calls (Distress)

◇ Receiving a Distress Acknowledgment



When a Distress Acknowledgment is received:

- The emergency alarm sounds until it is turned OFF.
 - “Received Distress ACK” is displayed.
1. Push **Alarm Off**  to turn OFF the alarm.

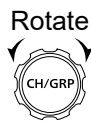
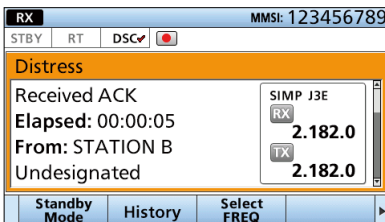
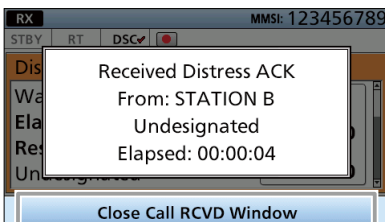

2. Push **Close Call RCVD Window** .





- One of the Emergency Frequencies is automatically selected. Monitor it because a coast station may require assistance.
 - Rotate [CH/GRP] to confirm the call contents.
3. Push **Standby Mode** , and then **OK**  to return to the Main screen.

◇ Receiving a Distress Cancel call



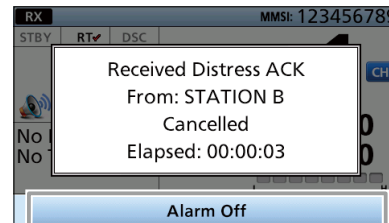

When a Distress Cancel call is received:

- The emergency alarm sounds until you turn it OFF.
 - “Received Distress ACK” is displayed.
1. Push **Alarm Off**  to turn OFF the alarm.

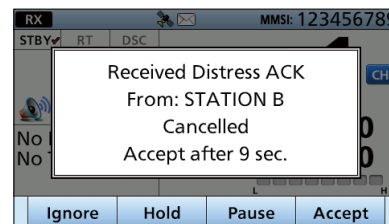





1. When “Accept after 10 sec.” or “Ignore after 10 sec.” is selected in the CH Auto Switch setting, the countdown is displayed on the bottom of the window. (p. 50)
After 10 seconds have passed since **Alarm Off**  was pushed, the screen will move to the DSC Task screen or return to the Main screen.
2. Push the Software Key below the intended operation.

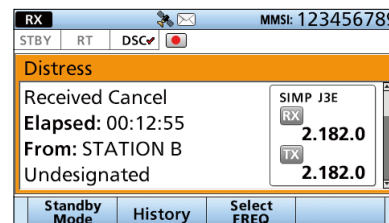

- Ignore** : Ignores the call and returns to the Main screen.
- Hold** : Puts the RX task on hold and returns to the Main screen.
- Pause** : Pauses the countdown.
- Accept** : Enters the DSC Task mode immediately.



- One of the Emergency Frequencies is automatically selected. Monitor it because a coast station may require assistance.
 - Rotate [CH/GRP] to confirm the call contents.
3. Push **Standby Mode** , and then **OK**  to return to the Main screen.

TIP: When **Pause**  is pushed in step 2, the countdown will be paused. Push **Resume**  to resume the countdown.

◇ Receiving a Distress Relay call

When a Distress Relay call is received:

- The emergency alarm sounds until you turn it OFF.
 - “Received Distress Relay” is displayed.
1. Push **Alarm Off**  to turn OFF the alarm.

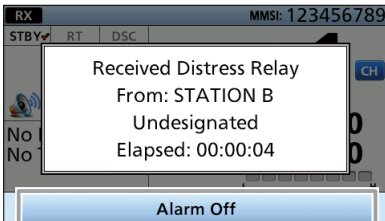





① When “Accept after 10 sec.” or “Ignore after 10 sec.” is selected in the CH Auto Switch setting, the countdown is displayed on the bottom of the window. (p. 50)

After 10 seconds have passed since **Alarm Off**  was pushed, the screen will move to the DSC Task screen or return to the Main screen.



2. Push the Software Key below the intended operation.



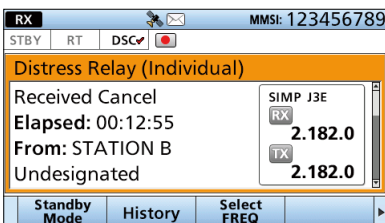

- Ignore** : Ignores the call and returns to the Main screen.
- Hold** : Puts the RX task on hold and returns to the Main screen.
- Pause** : Pauses the countdown.
- Accept** : Enters the DSC Task mode immediately.



- One of the Emergency Frequencies is automatically selected. Monitor it because a coast station may require assistance.
 - Rotate [CH/GRP] to confirm the call contents.
- ① See page 23 for details of the Software Key functions in the DSC Task mode.

3. Push **Standby Mode** , and then **OK**  to return to the Main screen.

TIP: When **Pause**  is pushed in step 2, the countdown will be paused. Push **Resume**  to resume the countdown.

◇ Receiving a Distress Relay Acknowledgment

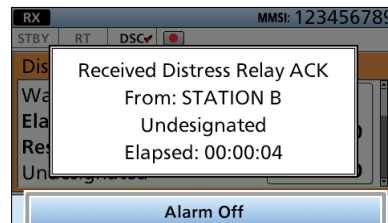

When a Distress Relay Acknowledgment is received:

- The emergency alarm sounds until it is turned OFF.
 - “Received Distress Relay ACK” is displayed.
1. Push **Alarm Off**  to turn OFF the alarm.

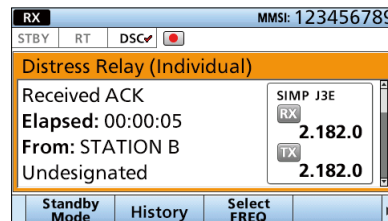
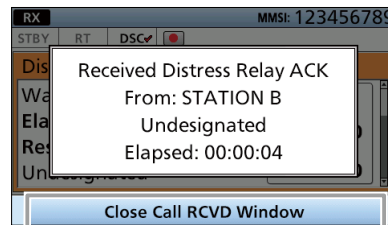

2. Push **Close Call RCVD Window** .



- One of the Emergency Frequencies is automatically selected. Monitor it because a coast station may require assistance.
 - Rotate [CH/GRP] to confirm the call contents.
- ① See page 23 for details of the Software Key functions in the DSC Task mode.
3. Push **Standby Mode** , and then **OK**  to return to the Main screen.

Receiving DSC calls (other)

Receiving an Individual call

NOTE:

- To receive an Individual call, push [D-SCAN] to enter the DSC watch mode. (p. 10)

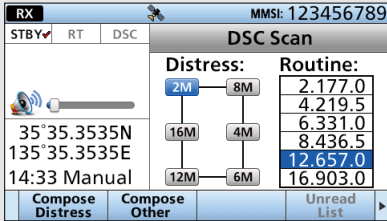

- When “Individual ACK” is set to “Auto (Able)” or “Auto (Unable),” the transceiver automatically sends an Acknowledgment “Able to comply” or “Unable to comply.” (p. 49)
In that case, both the TX and RX calls are saved in the Transmitted and Received Call Logs. (p. 46)

When an Individual call is received:

- The alarm sounds until you turn it OFF.
 - “Received Individual Call” is displayed.
- Push **Alarm Off** to turn OFF the alarm.

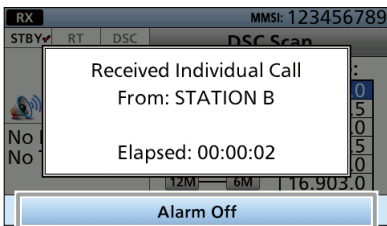

- Push the Software Key below the intended operation.

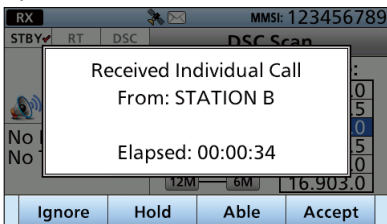

- Ignore**: Ignores the call and returns to the Main screen.
- Hold**: Puts the RX task on hold and returns to the Main screen.
- Able**: Sends an Acknowledgment “Able to comply” without any changes.
- Accept**: Enters the DSC Task mode immediately.

NOTE: When **Accept** is selected in this step, an Acknowledgment can be send in the DSC Task mode. To send the Acknowledgment, go to step 3. To return to the Main screen without sending the Acknowledgment, go to step 7.

- Push a key to select an Acknowledgment option.
 - The Call Contents screen is displayed.

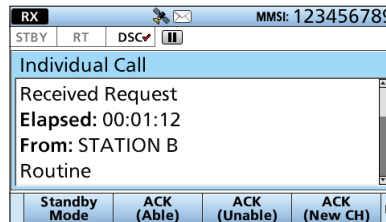

- Confirm the contents.

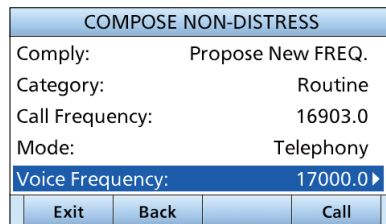

- Push **Call** to send an Individual Acknowledgment.
- Hold down [PTT] to talk.
- Push **Standby Mode**, and then **OK** to return to the Main screen.

TIP: When sending the Acknowledgment, select one of three options, depending on your situation. See pages 30 and 31 for details of the Individual Acknowledgment procedures.

◇ Receiving an Individual Acknowledgment

When receiving “ACK (Able)”:

You can communicate on the frequency specified for sending the call.

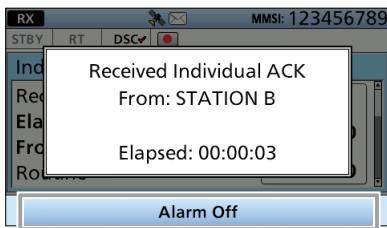

When “ACK (Able)” is received:

- The emergency alarm sounds until you turn it OFF.
 - “Received Individual ACK” is displayed.
1. Push **Alarm Off**  to turn OFF the alarm.

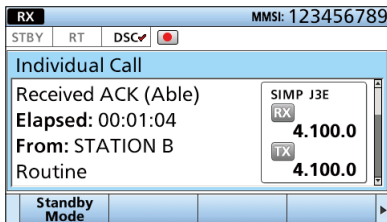
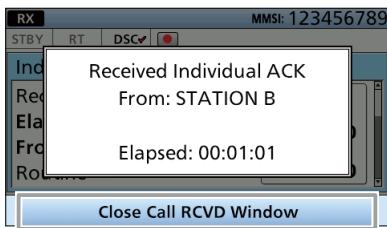

2. Push **Close Call RCVD Window** .



- The voice frequency specified when sending the call is automatically selected.
 - Rotate [CH/GRP] to confirm the call contents.
- ① See page 23 for details of the Software Key functions in the DSC Task mode.
 3. Hold down [PTT], and then communicate normally.
 4. After you have finished your call, push **Standby Mode** , and then **OK**  to return to the Main screen.

When receiving “ACK (Unable)”:

You cannot communicate further.

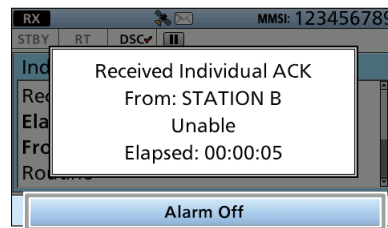

When “ACK (Unable)” is received:

- The emergency alarm sounds until you turn it OFF.
 - “Received Individual ACK” is displayed.
1. Push **Alarm Off**  to turn OFF the alarm.

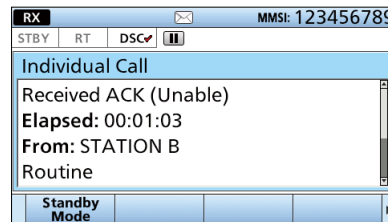
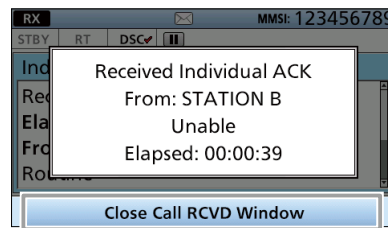

2. Push **Close Call RCVD Window** .



- Rotate [CH/GRP] to confirm the call contents.
- ① See page 23 for details of the Software Key functions in the DSC Task mode.
 3. Push **Standby Mode** , and then **OK**  to return to the Main screen.

6 DSC OPERATION

■ Receiving DSC calls (other)

◇ Receiving an Individual Acknowledgment (Continued)

When receiving “ACK (New CH)”:

You can communicate on the frequency specified by the called station.

When “ACK (New CH)” is received:

- The emergency alarm sounds until you turn it OFF.
- “Received Individual ACK” is displayed.

1. Push **Alarm Off**  to turn OFF the alarm.

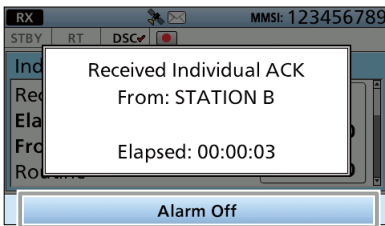

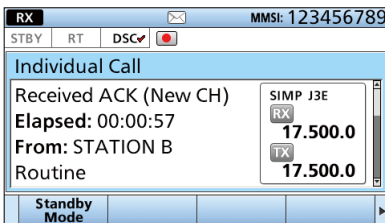
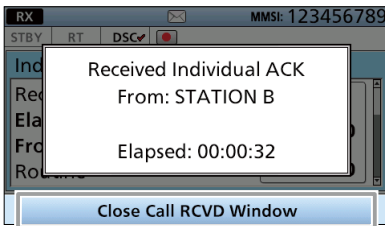

2. Push **Close Call RCVD Window** .



Rotate



- The voice frequency specified by the called station is automatically selected.
 - Rotate [CH/GRP] to confirm the call contents.
- ① See page 23 for details of the Software Key functions in the DSC Task mode.
 3. Hold down [PTT], and then communicate normally.
 4. After you have finished your call, push **Standby Mode** , and then **OK**  to return to the Main screen.

◇ Receiving a Group call

NOTE: To receive a Group call, push [D-SCAN] to enter the DSC watch mode. (p. 10)

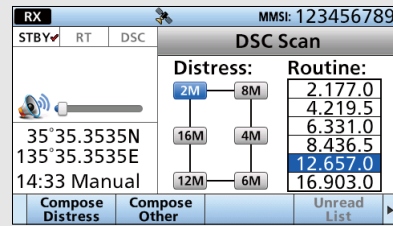

When a Group call is received:

- The emergency alarm sounds until you turn it OFF.
- “Received Group Call” is displayed.

1. Push **Alarm Off**  to turn OFF the alarm.



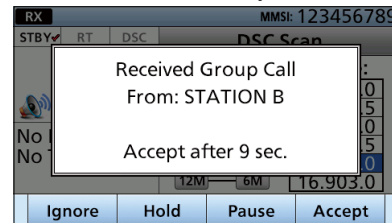

- ① When “Accept after 10 sec.” or “Ignore after 10 sec.” is selected in the CH Auto Switch setting, the countdown is displayed on the bottom of the window. (p. 50)
After 10 seconds have passed since **Alarm Off**  was pushed, the screen will move to the DSC Task screen, or return to the Main screen.

2. Push the Software Key below the intended operation.



Ignore : Ignores the call and returns to the Main screen.

Hold : Puts the RX task on hold and returns to the Main screen.

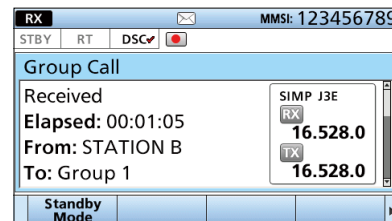

Pause : Pauses the countdown.

Accept : Immediately enters the DSC Task mode.



Rotate



- Monitor the voice frequency specified by the calling station.
 - ① Rotate [CH/GRP] to confirm the call contents.
 - ① See page 23 for details of the Software Key functions in the DSC Task mode.
3. Push **Standby Mode** , and then **OK**  to return to the Main screen.

TIP: When **Pause** [] is pushed in step 2, the countdown will be paused. Push **Resume** [] to resume the countdown.

◇ Receiving a Geographical Area call

When a Geographical Area call is received:

- The emergency alarm sounds until you turn it OFF.
 - “Received Geographical” is displayed.
1. Push **Alarm Off** [] to turn OFF the alarm.



- ① When “Accept after 10 sec.” or “Ignore after 10 sec.” is selected in the CH Auto Switch setting, the countdown is displayed on the bottom of the window. (p. 50)
After 10 seconds have passed since **Alarm Off** [] was pushed, the screen will move to the DSC Task screen, or return to the Main screen.

2. Push the Software Key below the intended operation.

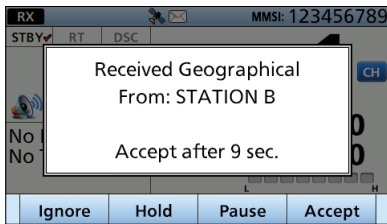

- Ignore** []: Ignores the call and returns to the Main screen.
- Hold** []: Puts the RX task on hold and returns to the Main screen.
- Pause** []: Pauses the countdown.
- Accept** []: Enters the DSC Task mode immediately.

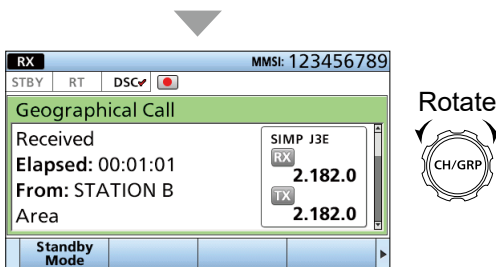

- Monitor the voice frequency specified by the calling station.
- ① Rotate [CH/GRP] to confirm the call contents.
 - ① See page 23 for details of the Software Key functions in the DSC Task mode.
3. Push **Standby Mode** [], and then **OK** [] to return to the Main screen.

TIP: When **Pause** [] is pushed in step 2, the countdown will be paused. Push **Resume** [] to resume the countdown.

◇ Receiving a Position Request call

NOTE: When “Position ACK” is set to “Auto (Able),” the transceiver automatically sends an Acknowledgment. (p. 49)

In that case, both the TX and RX calls are saved in the Transmitted and Received Call Logs. (p. 46)

When a Position Request is received:

- The emergency alarm sounds until you turn it OFF.
- “Received Position Request” is displayed.

1. Push **Alarm Off** [] to turn OFF the alarm.

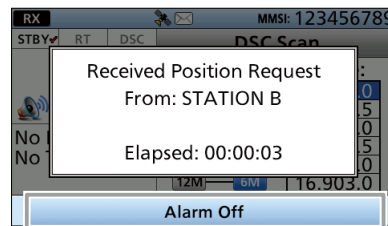

2. Push the Software Key below the intended operation.

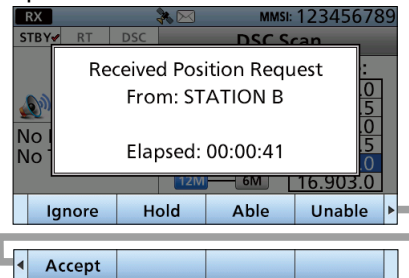

- Ignore** []: Ignores the call and returns to the Main screen.
- Hold** []: Puts the RX task on hold and returns to the Main screen.
- Able** []: Sends an Acknowledgment with the position and time data.
- Unable** []: Sends an Acknowledgment with no position and time data.
- Accept** []: Immediately enters the DSC Task mode.

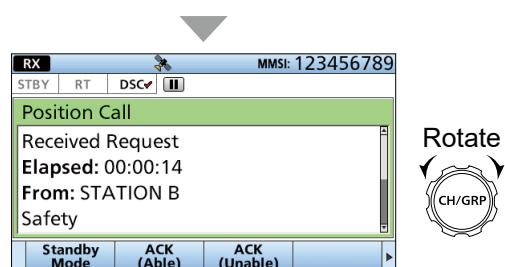

- ① Rotate [CH/GRP] to confirm the call contents.
 - ① See page 23 for details of the Software Key functions in the DSC Task mode.
3. Push **Standby Mode** [], and then **OK** [] to return to the Main screen.

TIP: See pages 35 and 36 for details of the Position Request Acknowledgment procedures.

6 DSC OPERATION

■ Receiving DSC calls (other)

◇ Receiving a Test call

NOTE: When “Test ACK” is set to “Auto,” the transceiver automatically sends an Acknowledgment. (p. 49)
In that case, both the TX and RX calls are saved in the Transmitted and Received Call Logs. (p. 46)

When a Test call is received:

- The alarm sounds until you turn it OFF.
 - “Received Test Call” is displayed.
1. Push **Alarm Off**  to turn OFF the alarm.

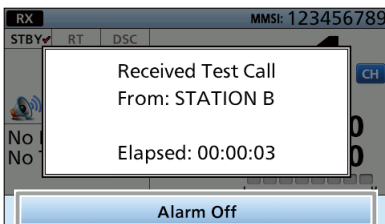



2. Push the Software Key below the intended operation.



Ignore : Ignores the call and returns to the Main screen.



Hold : Puts the RX task on hold and returns to the Main screen.

Able : Sends an Acknowledgment “Able to comply.”

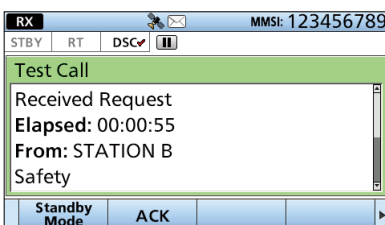
Accept : Immediately enters the DSC Task mode.



- ① Rotate [CH/GRP] to confirm the call contents.
- ① See page 23 for details of the Software Key functions in the DSC Task mode.

3. Push **Standby Mode** , and then **OK**  to return to the Main screen.

TIP: See page 37 for details of the Test Acknowledgment procedures.

◇ Receiving a Test Acknowledgment

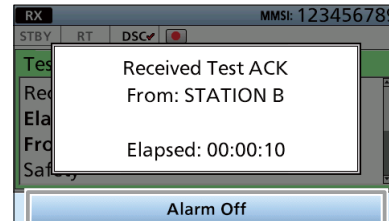

When a Test Acknowledgment is received:

- The alarm sounds until you turn it OFF.
 - “Received Test ACK” is displayed.
1. Push **Alarm Off**  to turn OFF the alarm.

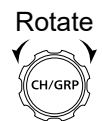
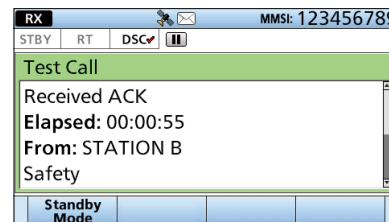
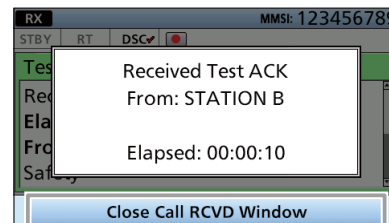

2. Push **Close Call RCVD Window** .



- ① Rotate [CH/GRP] to confirm the call contents.
 - ① See page 23 for details of the Software Key functions in the DSC Task mode.
3. Push **Standby Mode** , and then **OK**  to return to the Main screen.

■ DSC Log

◇ Received DSC Log

The transceiver can save up to 50 received Distress call messages, and 50 received DSC call messages in the DSC Log.

1. Push **DSC Log** .
 - The “Received Call Log” screen is displayed.
 - ① To display the screen from the Menu screen:

[MENU] > DSC Log > **Received Call Log**

2. Select “Distress” or “Others.”

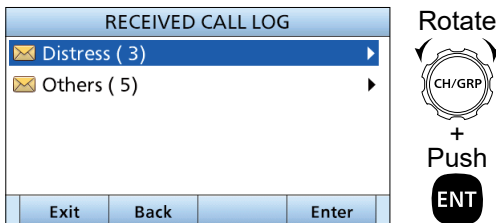

- ① “Distress” displays received Distress call logs, and “Others” displays received DSC call logs.
- ① “No Message” is displayed if no message is received.

3. Select a log to display the detailed information.

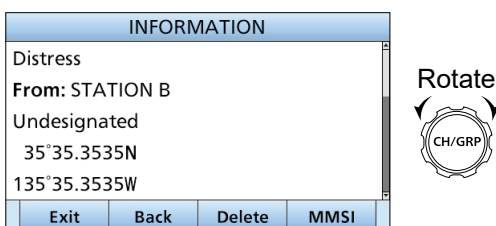
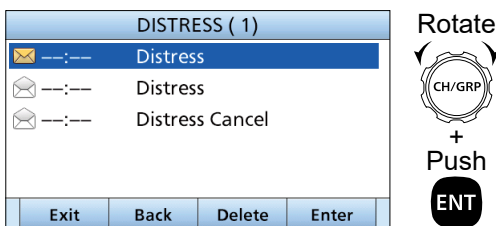

- Exit** : Push to return to the Main screen.
- Back** : Push to return to the previous screen.
- Delete** : Push to delete the selected message.
- Enter** : Push to go to the next screen.
- MMSI** : Push to show the caller station’s MMSI.

◇ Transmitted DSC Log

The transceiver can save up to 50 DSC transmitted calls in the DSC log.

1. Open “Transmitted Call Log.”
 - [MENU] > DSC Log > **Transmitted Call Log**
2. Select the log to display the detailed information.

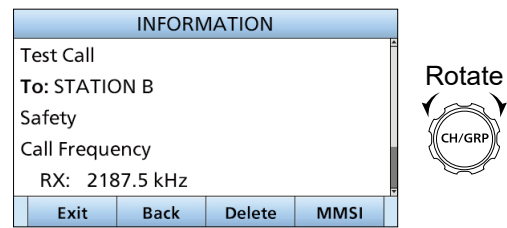
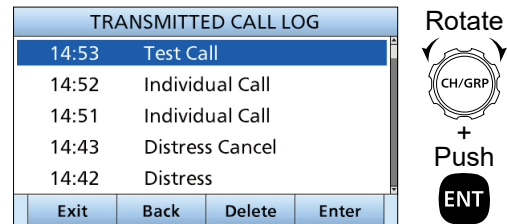

- Exit** : Push to return to the Main screen.
- Back** : Push to return to the previous screen.
- Delete** : Push to delete the selected call.
- Enter** : Push to go to the next screen.
- MMSI** : Push to show the destination station’s MMSI.

TIP:

- On the Main screen, is displayed when there is an unread DSC message.
- On the Main screen, blinks when a new DSC message is received.
- On the Main screen, no icon is displayed when there is no DSC message.
- A Distress message is saved in “Distress.”
- A DSC message is saved in “Others.”
- is displayed for an unread DSC message in the Received DSC Log screen.
- is displayed for a DSC message already read in the Received DSC Log screen.

DSC Settings

- ◇ Position Input (p. 22)
- ◇ Individual ID (p. 20)
- ◇ Group ID (p. 20)

DSC Frequency

These frequencies are selectable when sending an Individual call, Group call, and Geographical Area call. Usually, your dealer has set all the DSC frequencies to be usable.

To add a new DSC frequency:

1. Open "DSC Frequency."

[MENU] > DSC Settings > DSC Frequency

2. Select a DSC frequency number.

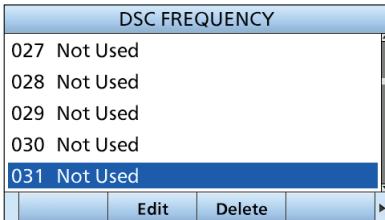

3. Select "Use."

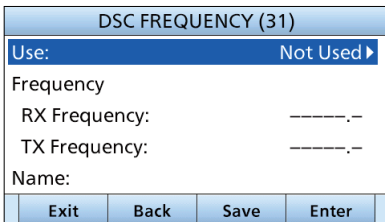

4. Select an option.

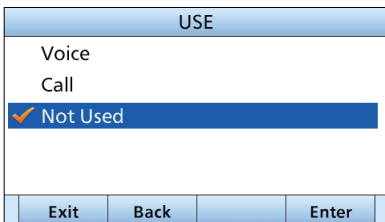

5. Select "Frequency."

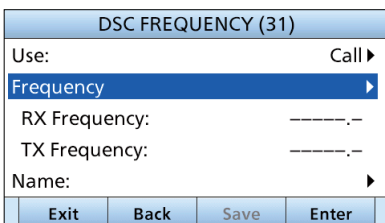

6. Enter a receive frequency, and then push **Finish**.

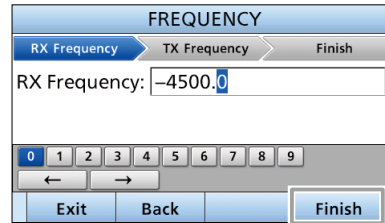

7. Enter a transmit frequency, and then push **Finish**.

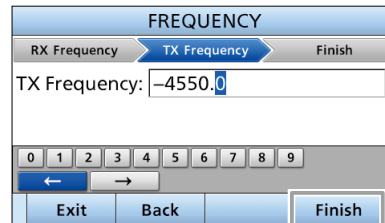

8. Select "Name."

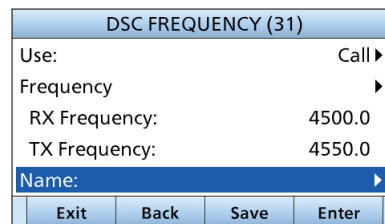

9. Enter a DSC frequency name, and then push **Finish**.

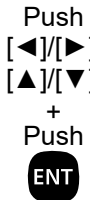
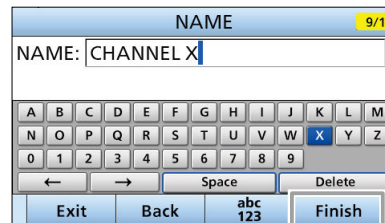

- Push **Save** .
 - “Are You Sure?” is displayed.

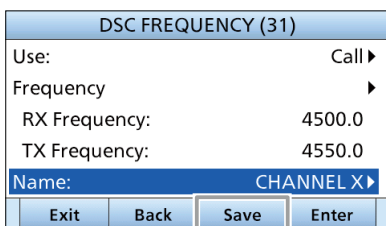

- Push **OK** to save the ID.
 - The entered name is displayed.

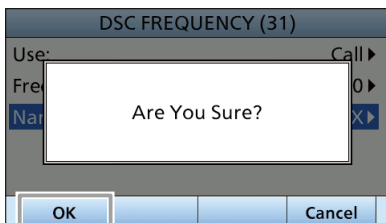

- Push [MENU] to return to the Main screen.

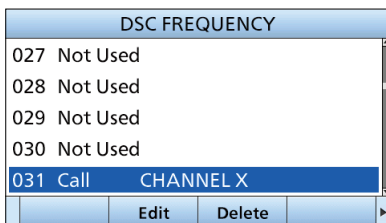

◇ Scanning Receiver

You can turn the Scanning Receiver function ON or OFF on each Emergency Frequency.

When selecting “Distress frequency”

NOTE: You cannot turn OFF the function on 2187.5 kHz and 8414.5 kHz, and 1 of the remaining 4 frequencies.

- Open “Distress.”
 - [MENU] > DSC Settings > Scanning Receiver > **Distress**

- Select a frequency.

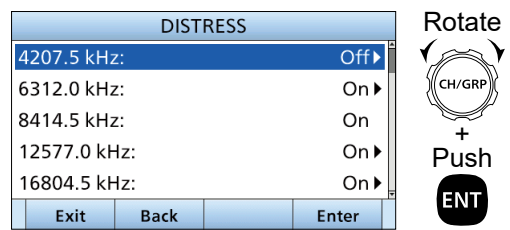

- Select an option.

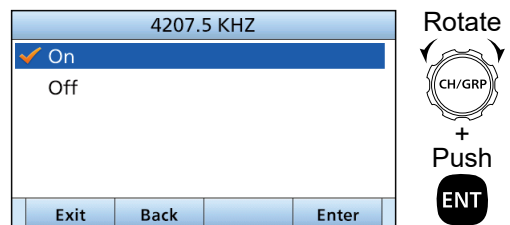

- On: The Emergency frequency is scanned during the Distress scan.
- Off: The Emergency frequency is skipped during the Distress scan.

- Push [MENU] or **Exit** to return to the Main screen.

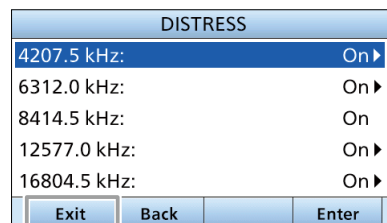

6 DSC OPERATION

■ DSC Settings

◇ Scanning Receiver (Continued)

When selecting or editing “Routine frequency”

1. Open “Routine.”

[MENU] > DSC Settings > Scanning Receiver > **Routine**

2. Select a channel.

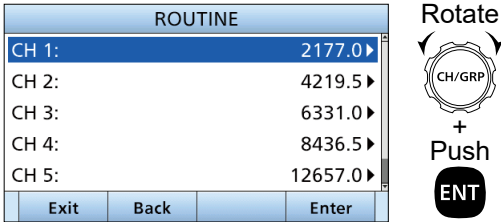

3. Enter a Routine frequency, and then push **Finish** .

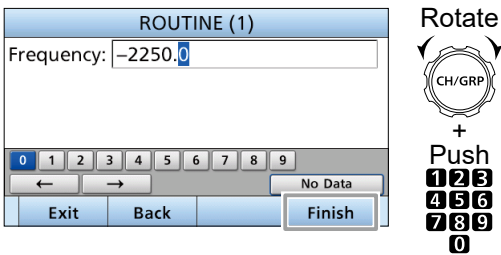

4. Push [MENU] or **Exit**  to return to the Main screen.

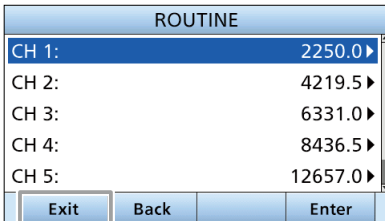

◇ Auto ACK

The Auto ACK function automatically sends an Acknowledgment when an appropriate request is received.

1. Open “Auto ACK.”

[MENU] > DSC Settings > **Auto ACK**

2. Select an item.

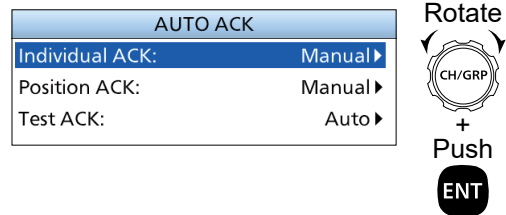

3. Select an option.

● Individual ACK

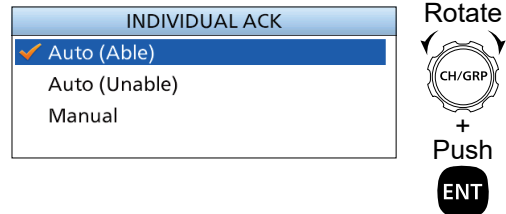

- Auto (Able): Automatically sends “Able to comply.”
- Auto (Unable): Automatically sends “Unable to comply.”
- Manual: Manually sends an Acknowledgment.

● Position ACK

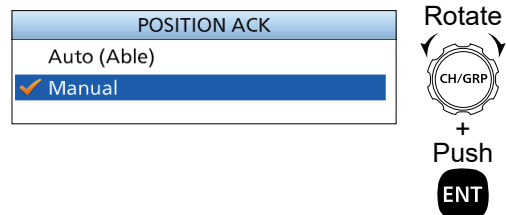

- Auto (Able): Automatically sends an Acknowledgment with the position and time data.
- Manual: Manually sends an Acknowledgment.

● Test ACK

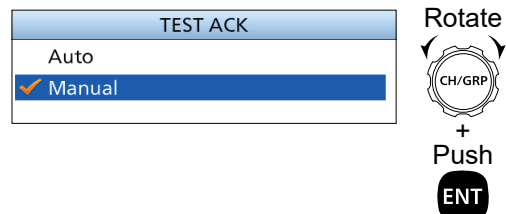

- Auto: Automatically sends an Acknowledgment.
- Manual: Manually sends an Acknowledgment.

4. Push [MENU] or **Exit**  to return to the Main screen.

◇ CH Auto Switch

According to the regulation, after receiving a DSC call, the transceiver's operating channel is switched to the specified channel by the call. However, when this function is set to "Ignore after 10 sec.," the transceiver's operating channel is not switched, even after receiving a DSC call.

1. Open "CH Auto Switch."

[MENU] > DSC Settings > **CH Auto Switch**

2. Select an option.

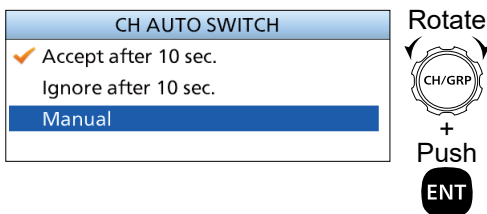

- **Accept after 10 sec.:**
After receiving a DSC call, the transceiver remains on the current operating channel for 10 seconds. After that, the transceiver automatically switches to the channel specified by the call.
- **Ignore after 10 sec.:**
After receiving a DSC call, if **Accept**  is not pushed within 10 seconds, the transceiver ignores the call and remains on the current operating channel.
- **Manual:**
After receiving a DSC call, you can select whether or not to accept the call.

3. Push [MENU] or **Exit**  to return to the Main screen.

◇ NMEA Data Output

When receiving a DSC call from the station selected in this setting, the transceiver outputs the DSC data to the NMEA output port.

① You can send Distress calls regardless of this setting.

1. Open "NMEA Data Output."

[MENU] > DSC Settings > **NMEA Data Output**

2. Select an option.

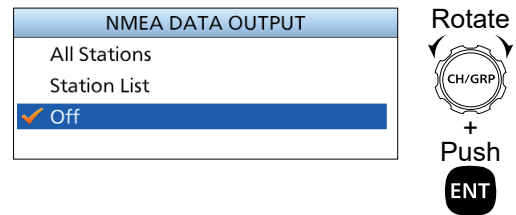

- **All Stations:** From any station.
- **Station List:** From the stations entered in the Individual ID or Group ID setting on the Menu screen.
- **Off:** Does not output any DSC data from the NMEA Output port.

6 DSC OPERATION

■ DSC Settings

◇ Alarm Status

Sets the alarm ON or OFF when receiving each type of DSC call.

Safety/Routine

Select whether or not to sound an alarm when receiving a Safety or Routine DSC call.

1. Open "Alarm Status."

[MENU] > DSC Settings > **Alarm Status**

2. Select "Safety" or "Routine."

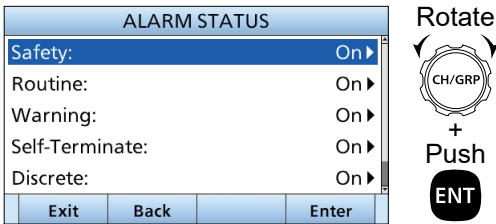

3. Select an option.

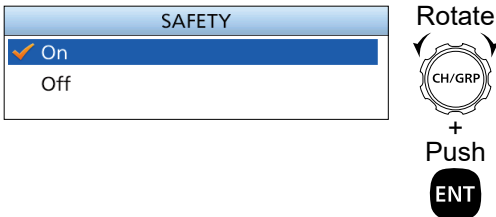

- On: Alarm sounds.
- Off: Alarm does not sound.

4. Push [MENU] or **Exit**  to return to the Main screen.

Warning

Select whether or not to sound an alarm for when:

- No MMSI is entered.
- The received position data has not been updated for 10 minutes.
- The position data has not been manually updated for 4 hours.
- The received or manually entered position data has not been updated for 23.5 hours.

1. Open "Alarm Status."

[MENU] > DSC Settings > **Alarm Status**

2. Select "Warning."

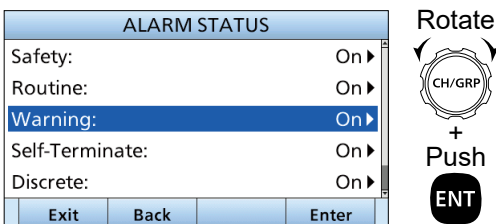

3. Select an option.

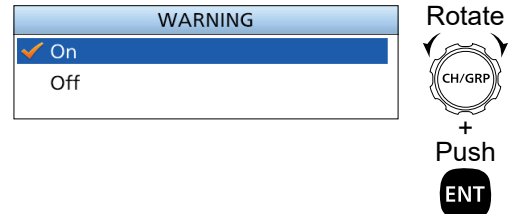

- On: Alarm sounds.
- Off: Alarm does not sound.

4. Push [MENU] or **Exit**  to return to the Main screen.

Self-Terminate

Select whether or not to sound an alarm when receiving the same Distress call.

1. Open "Alarm Status."

[MENU] > DSC Settings > **Alarm Status**

2. Select "Self-Terminate."

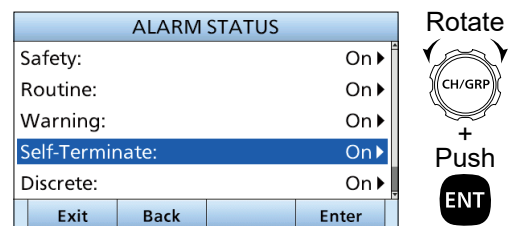

3. Select an option.

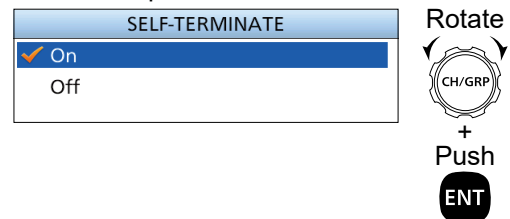

- On: Alarm sounds.
- Off: Alarm does not sound.

4. Push [MENU] or **Exit**  to return to the Main screen.

Discrete

Select whether or not to sound an alarm when receiving a lower priority DSC call while currently receiving a higher priority call.

1. Open "Alarm Status."

[MENU] > DSC Settings > **Alarm Status**

2. Select "Discrete."

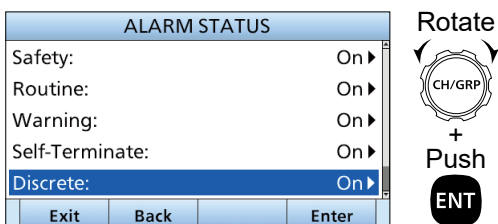

3. Select an option.

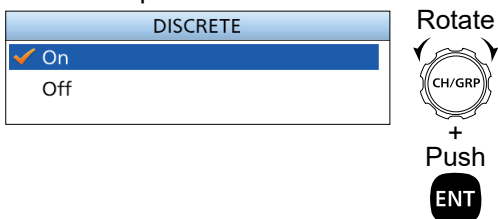

- On: Alarm sounds.
- Off: Alarm does not sound.

4. Push [MENU] or **Exit** to return to the Main screen.

MAX Distance 2-Tone

Set the maximum distance between vessels for the ringing of the 2-tone alarm is enabled.

1. Open "Alarm Status."

[MENU] > DSC Settings > **Alarm Status**

2. Select "MAX Distance 2-Tone."

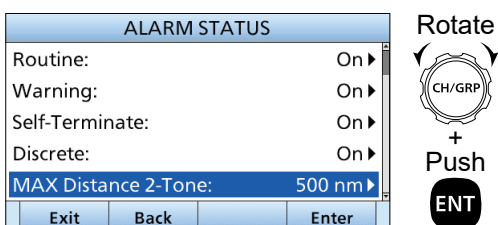

3. Enter the maximum distance.

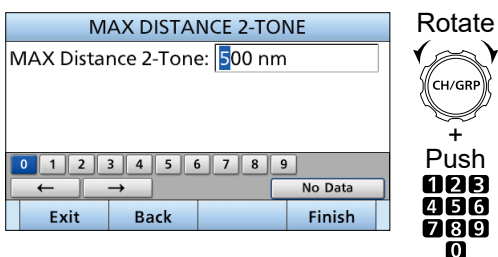

4. Push [MENU] or **Exit** to return to the Main screen.

Self Check Test

The Self Check Test sends DSC signals to the receiving AF circuit to compare the sending and receiving signals at the AF level.

1. Open "Self Check Test."

[MENU] > DSC Settings > **Self Check Test**

2. Push [ENT], or **Enter** to start the Self Check Test.

① When the sending and receiving DSC signals match, "OK" is displayed.

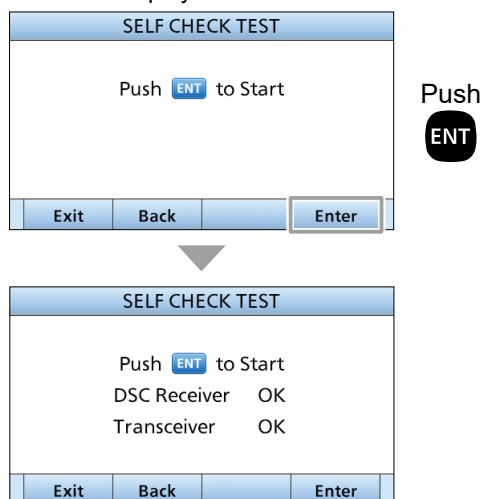

■ About the Menu screen

The Menu screen is constructed in a tree structure and used to set items, select options, and so on for the transceiver's functions.

You can go to the next tree level by pushing [ENT], or [▶], and go back a level by pushing [CLR], or [◀].

① The displayed menu items may differ, depending on the transceiver version or presetting.

To select an item, rotate [CH/GRP], or push [▲] and [▼].

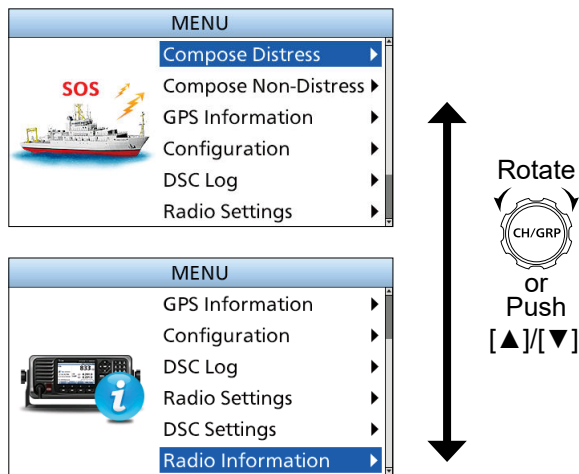

■ Selecting the item

Follow the procedures described below to select a Menu screen.

Example: Turning ON the Voice Squelch function.

1. Open "Voice SQL."

[MENU] > Radio Settings > **Voice SQL**

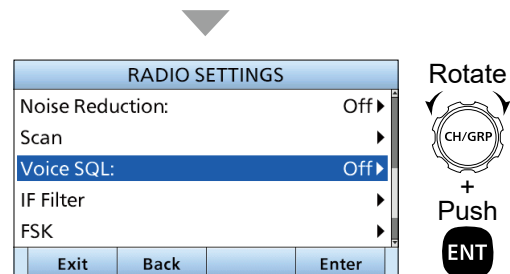
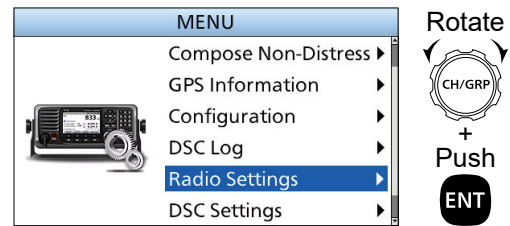

2. Select "On."

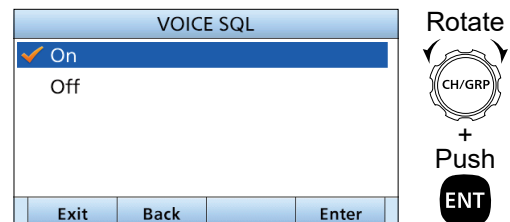

- Returns to the Radio Settings screen.

3. Push [MENU], or **Exit**  to return to the Main screen.

■ Menu Construction

The Menu screen is constructed in a tree structure, and the following items are described in each section. Refer to the pages in the chart for details.

① The displayed menu items may differ, depending on the transceiver version or presetting.

Compose Distress	
Nature of Distress	p. 25
Position	p. 25
• Latitude	
• Longitude	
• UTC	
Mode	p. 20
Attempt	p. 25
Compose Non-Distress	
Message Type	p. 29
Address	p. 29
Area	p. 44
• Latitude	
• Longitude	
• Radius	
• Height	
• Width	
Category	p. 34
Call Frequency	p. 29
• RX Frequency	
• TX Frequency	
Mode	p. 20
Voice Frequency	p. 29
• RX Frequency	
• TX Frequency	
GPS Information	
	p. 56

Configuration	
Display	p. 56
• Backlight	
• Mode	
• Night Mode Time	
Key Beep	p. 56
Key Assignment	p. 18
• Softkey Assignment	
• Volume Dial Assignment	
• P Key Assignment	
MIC Key Lock	p. 56
UTC Offset	p. 56
Inactivity Timer	p. 56
• Not DSC Related	
• DSC Related	
• Distress Related	
• RT Related (J3E/H3E/LSB/J2B/F1B/A1A)	
GPS	p. 57
• Internal GPS	
• External GPS	
• NMEA Data Output	
Remote	p. 57
• Interface	
• MOD	
• Baud Rate	
NMEA2000	p. 57
• GPS	

► Continued on the next page.

7 MENU SCREEN

■ Menu Construction

DSC Log	
Received Call Log	p. 46
• Distress	
• Others	
Transmitted Call Log	p. 46
Radio Settings	
TX Meter	p. 58
User CH	p. 17
MAX User CH	p. 58
ITU Simplex CH	p. 17
Auto Tune	p. 58
External Tuner	p. 58
Noise Reduction	p. 58
Scan	p. 59
• Type	
• Speed	
• Program Scan FREQ	
Voice SQL	p. 59
IF Filter	p. 59
• J2B Filter	
• F1B Filter	
FSK	p. 59
• ITU FSK CH	
• Mark Frequency	
• Shift Frequency	
• Polarity	
Instant Replay	p. 60
• Function	
• Recording Time	
• Play Time	

DSC Settings	
Position Input	p. 22
Individual ID	p. 20
Group ID	p. 20
DSC Frequency	p. 47
Scanning Receiver	p. 48
• Distress	
• Routine	
Auto ACK	p. 49
• Individual ACK	
• Position ACK	
• Test ACK	
CH Auto Switch	p. 50
NMEA Data Output	p. 50
Alarm Status	p. 51
• Safety	
• Routine	
• Warning	
• Self-Terminate	
• Discrete	
• MAX Distance 2-Tone	
Self Check Test	p. 52
Radio Information	
	p. 60

■ GPS Information

Displays your position, time, Speed Over Ground (SOG), and Course Over Ground (COG) using the external GPS receiver data.

■ Configuration

◇ Displays

● Backlight

[MENU] > Configuration > Display > **Backlight**

You can adjust the backlight brightness level of the Day mode and the Night mode displays.

Day mode

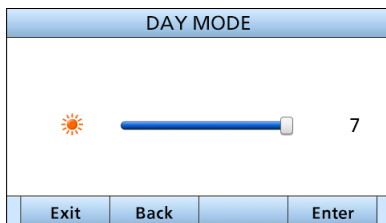

Night mode

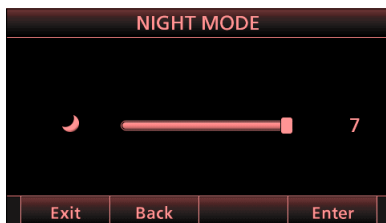

● Mode

[MENU] > Configuration > Display > **Mode**

Set the LCD backlight mode.

- Day mode: The screen is displayed in the Day mode.
- Night mode: The screen is displayed in the Night mode.
- Auto: The Day mode or the Night mode is automatically selected.

● Night Mode Time

[MENU] > Configuration > Display > **Night Mode Time**

Set the start time and end time of the Night mode.

◇ Key Beep

[MENU] > Configuration > **Key Beep**

Turn the Key Beep function ON or OFF.

- On: When you push a key, a beep sounds.
- Off: Turns OFF the function for silent operation.

◇ Key Assignment

[MENU] > Configuration > **Key Assignment**

You can assign some functions to the Software Keys to create convenient shortcuts. See pages 18 and 19 about how to assign.

◇ MIC Key Lock

[MENU] > Configuration > **MIC Key Lock**

Turn the MIC Key Lock function ON or OFF.

- On: All keys except [PTT] on the microphone are locked.
- Off: Turns OFF the Key Lock.

◇ UTC Offset

[MENU] > Configuration > **UTC Offset**

Set the offset time between Universal Time Coordinated (UTC) and your local time to between -14:00 and +14:00 (in 1 minute steps).

◇ Inactivity Timer

[MENU] > Configuration > **Inactivity Timer**

The transceiver automatically returns to the Main screen if you push no key for each mode's set period of time. The countdown alarm sounds 10 seconds before the Inactivity Timer activates.

For Not DSC Related, DSC Related, and Distress Related:

Set the Inactivity Timer to between 1 and 15 minutes (in 1 minute steps), or OFF.

● Not DSC Related

[MENU] > Configuration > Inactivity Timer > **Not DSC Related**

Setting for when a screen that is not related to DSC is displayed.

● DSC Related

[MENU] > Configuration > Inactivity Timer > **DSC Related**

Setting for when a screen that is related to DSC is displayed.

● Distress Related

[MENU] > Configuration > Inactivity Timer > **Distress Related**

Setting for when a screen that is related to a Distress call is displayed.

■ Configuration

◇ Inactivity Timer (Continued)

For RT Related:

Set the Inactivity timer to 10 sec, 30 sec, or between 1 and 10 min (in 1 minute steps).

● RT Related

[MENU] > Configuration > Inactivity Timer > RT Related (J3E/H3E/LSB/J2B/F1B/A1A)

Setting for when the transceiver is in the Radio Telephone mode.

◇ GPS

● Internal GPS

[MENU] > Configuration > GPS > Internal GPS

Selects a satellite to be used for Global Positioning System (GPS) to pinpoint the geographic location of your transceiver anywhere in the world.

This setting may not be usable, depending on the transceiver version or presetting.

• GPS

The Global Positioning System (GPS) is permanently set to ON.

• GLONASS

Selects whether or not to use the data from the GLObal'naya NAVigatsionnaya Sputnikovaya Sistema (GLONASS) satellites.

• SBAS

Turns the Satellite Based Augmentation System (SBAS) function ON or OFF.

When turning ON this function, the GPS position accuracy can be improved.

● External GPS

[MENU] > Configuration > GPS > External GPS

• Baud Rate

Select the data transfer speed to receive data from an external GPS receiver from 4800, 9600, 19200, 38400 bps.

● NMEA Data Output

[MENU] > Configuration > GPS > NMEA Data Output

Select whether or not to output the position data from the NMEA output port.

- On: Outputs the position data from the NMEA output.
- Off: Does not output the position data.

◇ Remote

● Interface

[MENU] > Configuration > Remote > Interface

Set the interface format for the remote connector to NMEA or RS-232C.

● MOD

[MENU] > Configuration > Remote > MOD

Set the input/output terminal for connecting to/from an external unit to MIC or AF/MOD.

● Baud Rate

[MENU] > Configuration > Remote > Baud Rate

Set the data transfer speed to receive data from an external controller such as a PC, to 4800, 9600, 19200, or 38400 bps.

◇ NMEA2000

NMEA 2000 is a plug-and-play communication standard used to connect various marine devices and display units in the vessel. Communication is done in data units called Parameter Group Number (PGN). The transceiver can easily connect to an NMEA 2000 network and display the information provided by the devices on the network. Select the devices in the NMEA 2000 network, which send data to the transceiver.

① See the next page for the compatible PGN list.

● GPS

1. Open the "GPS" screen.

[MENU] > Configuration > NMEA2000 > GPS

- The transceiver starts searching the devices connected to the NMEA 2000 network.
- ① Push **Stop Searching** to stop searching devices and display the list of connected devices.

2. Select the device that sends the GPS data to the transceiver, and then push [ENT].

- Device name: The selected device is used.
- Auto: The first device that sends the GPS data to the transceiver or the device that sends a higher priority GPS data is used.
- Not used: No NMEA 2000 device is used.
- ① Push **Info** to display the detail of the device.
- ① If another device sends a higher priority GPS data to the transceiver after selecting "Auto," the device to be used will switch to that one. The order of priority is the GPS data with position correction, without position correction, and unpositioned.
- ① In the "Auto" item, the last connected device information is not saved.
- ① If the transceiver is connected to both NMEA 0183 and NMEA 2000 devices, the NMEA 2000 devices have priority. Select "Not Used" if you want to use only NMEA 0183 devices.

3. Push [MENU], or **Exit**  to return to the Main screen.

Compatible PGN list

Receive	
059392	ISO Acknowledgement
059904	ISO Request
060160	ISO Transport Protocol, Data Transfer
060416	ISO Transport Protocol, Connection Management
060928	ISO Address Claim
065240	ISO Commanded Address
126208	NMEA
126464	PGN List – Received PGN's group function
126996	Product Information
129026	Course Over Ground (COG) and Speed Over Ground (SOG), Rapid Update
129029	Global Navigation Satellite System (GNSS) Position Data

Transmit	
059392	ISO Acknowledgement
059904	ISO Request
060416	ISO Transport Protocol, Connection Management
060928	ISO Address Claim
126208	NMEA – Acknowledge group function
126464	PGN List – Transmit PGN's group function
126993	Heartbeat
126996	Product Information
126998	Configuration Information
129026	Course Over Ground (COG) and Speed Over Ground (SOG), Rapid Update
129029	Global Navigation Satellite System (GNSS) Position Data
129808	DSC Call Information

Radio Settings

- ◇ User CH (p. 17)
- ◇ ITU Simplex CH (p. 17)

◇ TX Meter

[MENU] > Radio Settings > **TX Meter**

Select the TX Meter display type from RF Power or Antenna Current.

◇ Max User CH

[MENU] > Radio Settings > **Max User CH**

Set the number of maximum User channels to between 1 and 160.

◇ Auto Tune

[MENU] > Radio Settings > **Auto Tune**

Turn the Auto Tune function ON or OFF. When this function is ON, tuning is automatically started when an optional antenna tuner is connected and the frequency is changed.

- On: When an optional antenna tuner is connected, tuning is automatically started.
- Off: When the operating frequency is changed, tuning by pushing [TUNE] is needed. (p. 3)

◇ External Tuner

[MENU] > Radio Settings > **External Tuner**

Select the external ICOM antenna tuner from AT-141, AT-130/E, AT-120/E, or AH-3.

◇ Noise Reduction

[MENU] > Radio Settings > **Noise Reduction**

Set the Noise Reduction level to between 1 and 15, or OFF.

■ Radio Settings

◇ Scan

● Type

[MENU] > Radio Settings > Scan > **Type**

Select a scan type to locate signals.

① See pages 13 for details.

- **CH/CH Resume:**
The CH and CH Resume searches within a 20 channel range, such as channel 1 to channel 20, in the user channels, and searches all channels in the same bandwidth in the ITU channels and ITU FSK channels.
- **Program:**
The Program scan searches the selected channel within the frequency range set by the “Start frequency” setting and the “End frequency” setting.

● Speed

[MENU] > Radio Settings > Scan > **Speed**

Set the scanning speed (the rate at which channels are searched) to between 1 (fast) and 10 (slow).

● Program Scan FREQ

[MENU] > Radio Settings > Scan > **Program Scan FREQ**

Set the Start Frequency and the End Frequency used for the Program scan.

◇ Voice SQL

[MENU] > Radio Settings > **Voice SQL**

Turn the Voice Squelch function ON or OFF when operating in the J3E and H3E modes. When this function is turned OFF, the squelch operates as an S-meter squelch in the J3E and H3E modes.

◇ IF Filter

[MENU] > Radio Settings > **IF Filter**

Set the IF Filter passband width for the J2B mode operation to Wide, Middle, or Narrow and for the F1B mode operation to Wide or Narrow.

◇ FSK

● ITU FSK CH

[MENU] > Radio Settings > FSK > **ITU FSK CH**

Select whether or not to use ITU FSK channels.

- On: The channels can be used.
- Off: The channels cannot be used.

● Mark Frequency

[MENU] > Radio Settings > FSK > **Mark Frequency**

Set the FSK mark frequency for FSK operation to 1200, 1275, 1487.5, 1615, 2100, or 2125 Hz.

● Shift Frequency

[MENU] > Radio Settings > FSK > **Shift Frequency**

Set the FSK shift frequency for FSK operation to 170, 200, 425, or 850 Hz.

● Polarity

[MENU] > Radio Settings > FSK > **Polarity**

Select the FSK polarity.

- Normal: Key open = space
Key close = mark
- Reverse: Key open = mark
Key close = space

◇ Instant Replay

● Function

[MENU] > Radio Settings > Instant Replay >
Function

Turn the Instant Replay function ON or OFF.
This function enables you to record the received audio and replay it.

● Recording Time

[MENU] > Radio Settings > Instant Replay >
Recording Time

The maximum recordable time is permanently set to 120 seconds.

● Play Time

[MENU] > Radio Settings > Instant Replay >
Play Time

Set the play start point of the recorded audio to between 5 and 120 seconds (in 5 second steps).
When **RX Play** is pushed, playback will start from the position rewound for the set time from the recording time.

■ Radio Information

Displays your transceiver's information.

RADIO INFORMATION			
MMSI:	123456789		
Serial No.:			
Main:	1.000		
Sub:	1.000		
FPGA:	1.000		
Exit	Back		

■ Supplied accessories

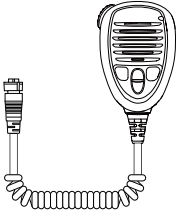

Microphone

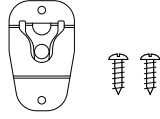

Microphone hanger and screws (3 × 16 mm)

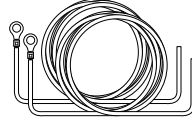

DC power cable (Red and Black)

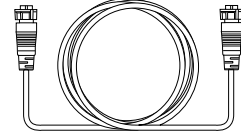

Remote control cable



RCA cable (for the GPS connection)



Weatherproof caps

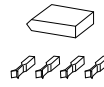

Tuner connector kit

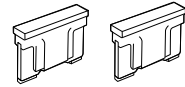

Spare fuses (APS 58 V 5 A)



Ferrite EMI filter (for the DC power cable)

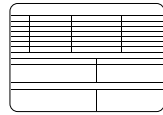

Emergency frequency sticker

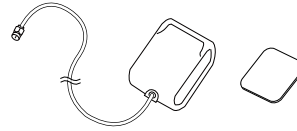

GPS antenna and double-sided adhesive pad

Mounting plates kit for the Main unit

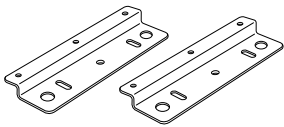

Mounting plates

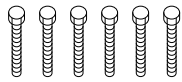

Hex head bolts (6 × 50 mm)

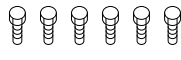

Hex head bolts (6 × 15 mm)



Spring washer (M6)

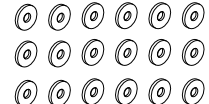

Flat washer (M6)

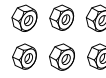

Hex nuts (M6)



Rubber feet

Mounting bracket kit for the remote controller

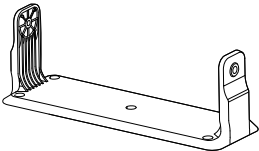

Mounting bracket

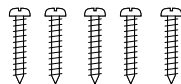

Self-tapping screws (M5)



Flat washers (M5)



Spring washers (M5)

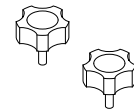

Screws (M5)

NOTE: Some accessories may not be supplied, or the shape may be different, depending on the transceiver version.

■ Connections

◇ Basic connections

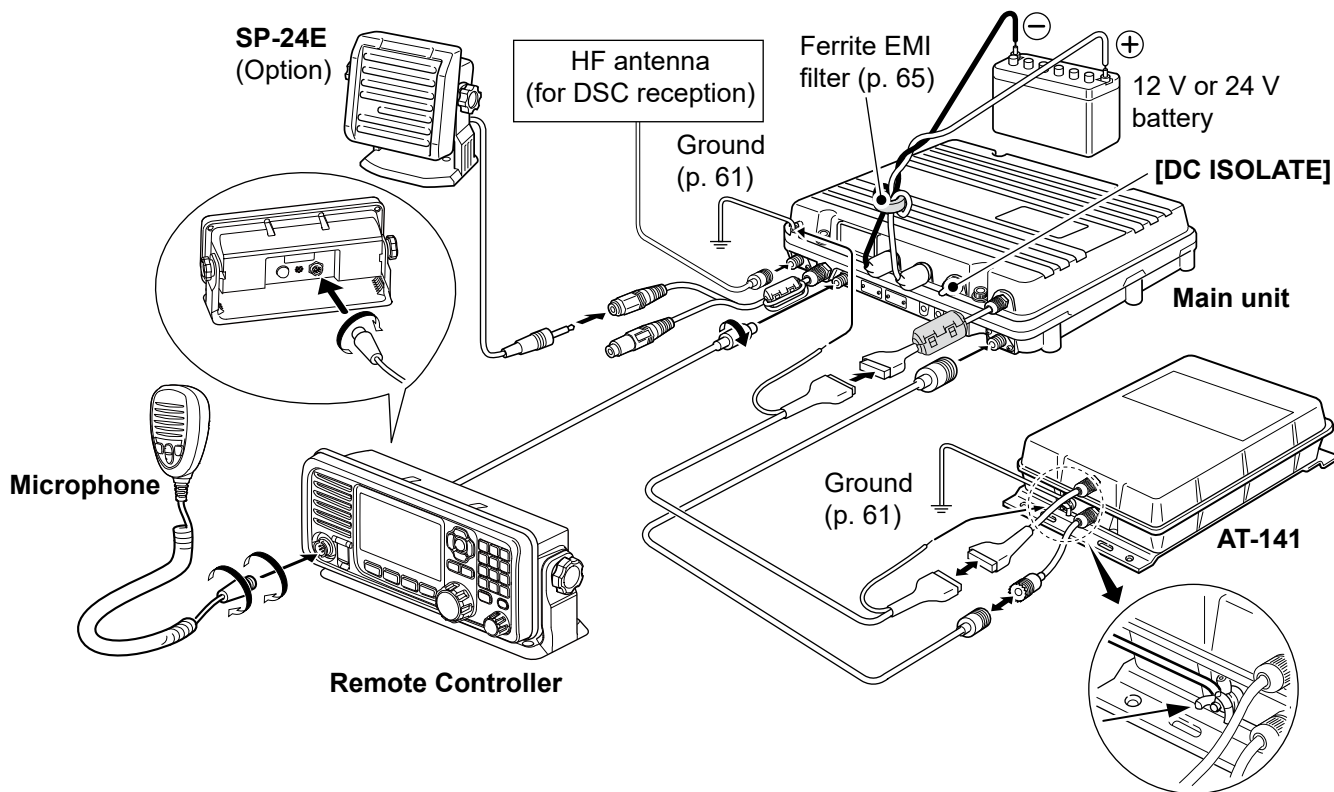

CAUTION:

- After connecting an antenna, tuner control cables, external speaker, or GPS receiver, cover the connectors with a rubber vulcanizing tape, as shown below, to prevent water from seeping into the connection.
- **DO NOT** pull on the antenna and control cable receptacles. It may cause cable disconnection (in the tuner unit), damage inside the connector, or a bad connection.

NOTE:

- When an external speaker is connected, the internal speaker is automatically muted.
- Turn OFF [DC ISOLATE] on the Main unit, or charge the battery while at anchor. Otherwise, the battery may become exhausted. The IC-M804 has a high-stability oven heater type crystal oscillator, and the oscillator's heater is directly connected to the DC power terminals. It keeps its temperature at a specified level, even if you turn OFF the power by holding down [⏻] on the remote controller.

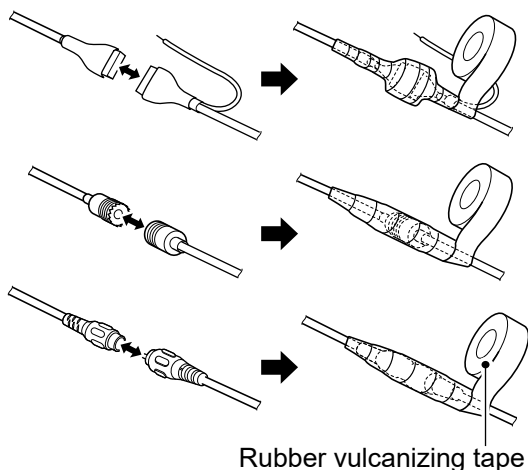

Rubber vulcanizing tape

8 CONNECTIONS AND INSTALLATION

■ Connections

◇ Advanced connections

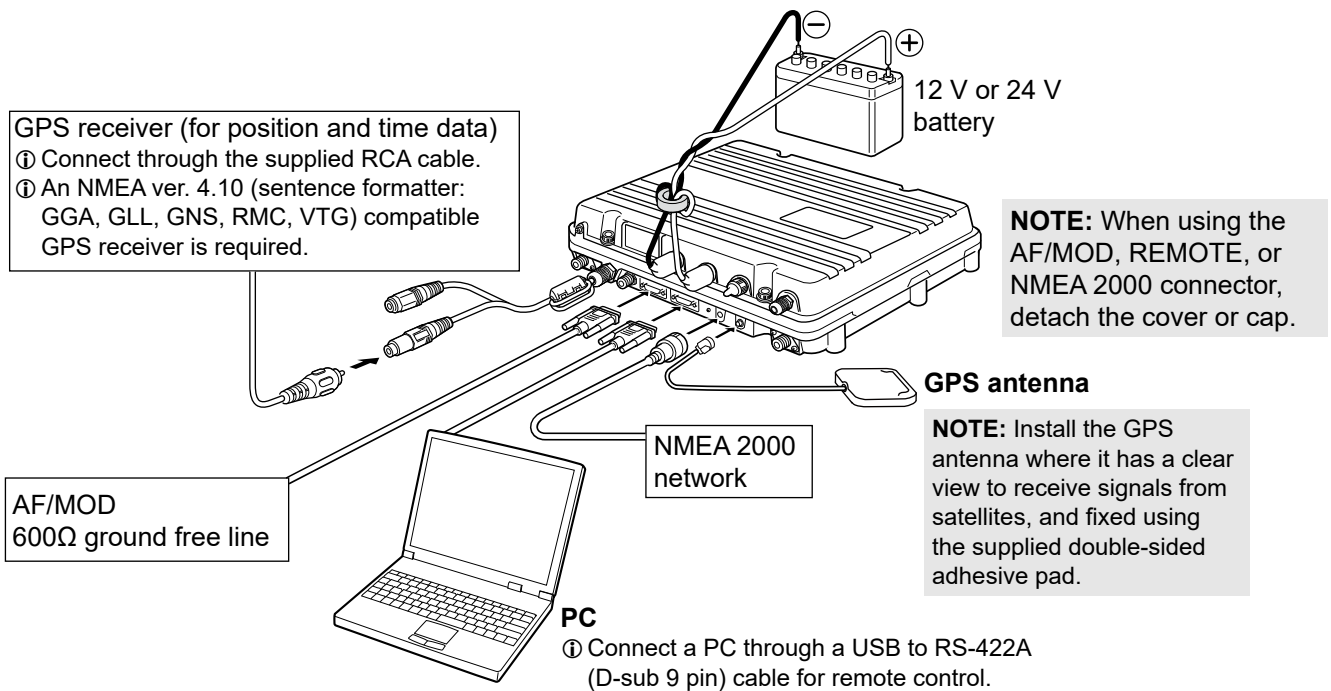

CAUTION: When an external unit is connected, such as a PC, it must be properly grounded. (p. 61)

TIP: When both a PC and the remote controller are connected

- The PC being operated has priority over the remote controller at any given time.
- The remote controller cannot be operated.
- The PC being operated automatically updates the settings of the remote controller.

◇ Connecting the microphone

1. Insert the microphone's connector into the microphone jack on the remote controller's front panel.
2. Rotate the connector clockwise until it is completely tightened.

CAUTION:

- **BE SURE** that the microphone's connector is completely screwed in. Otherwise, the remote controller may lose its waterproof protection.
- **DO NOT** use non-Icom microphones. Other manufacturer's microphones have different pin assignments, and a connection to the remote controller may damage it.



◇ **Connecting the remote control cable**

1. Insert the remote control cable's connector into the main unit jack on the remote controller's back panel.
2. Rotate the connector clockwise until it is completely tightened.

CAUTION: BE SURE that the control cable's connector is completely screwed to the remote controller's back panel. Otherwise, the remote controller may lose its waterproof protection.

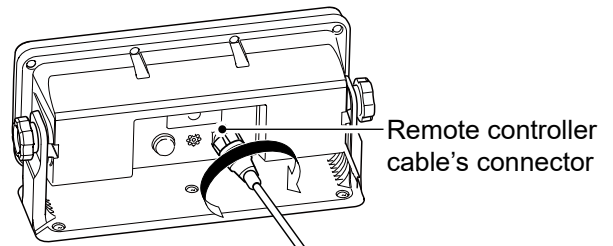

■ **Ground connection**

The transceiver and antenna tuner must have a proper RF ground connection. Otherwise, the efficiency of the transceiver and antenna tuner may be reduced. Also, electrolysis, electrical shocks, and interference with other equipment may occur. For the best results, use a 50 or 75 mm wide copper strap, and connect as short as possible. Ground the transceiver and antenna tuner to one ground point. Otherwise, the voltage difference (at the RF level) between the 2 ground points may cause electrolysis.

⚠ **WARNING!** When grounding to a metal hull, use Zinc anodes to protect the hull from electrolysis. Ask your dealer or installer for RF grounding details.

CAUTION:

- **DO NOT** connect the transceiver to a "positive-grounded vessel." Otherwise, the transceiver will not function.
- Any external units, such as a PC, must be properly grounded. We suggest using a wide copper strap.

Best ground points and materials

- External ground plate
- Copper screen
- Copper foil

Acceptable ground points

- Stainless steel stanchion
- Through mast
- Through hull
- Metal water tank

Undesirable ground points

- Engine block
- Vessel's DC battery ground

Unusable ground points

(These connections may cause an explosion or electrical shock)

- Gas or electrical pipe
- Fuel tank or oil catch pan

Ground system example

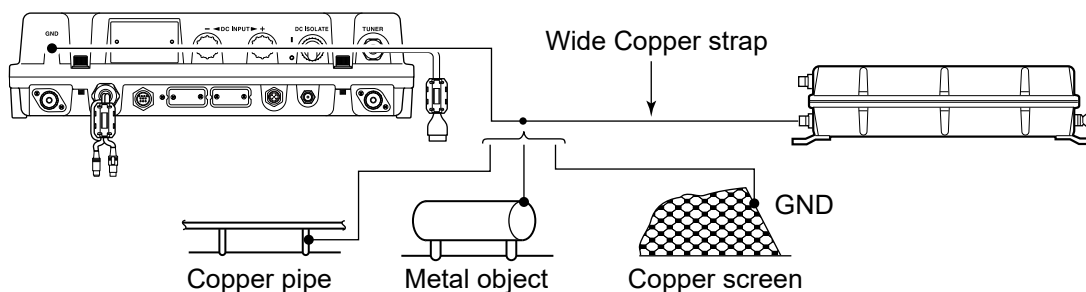

Power source

The transceiver requires a regulated DC power of 13.6 V and at least 60 A or 26.4 V and at least 30 A, depending on the transceiver version. Directly connect to a 12 V or 24 V battery in your vessel through the supplied DC power cable.

CAUTION:

- **DO NOT** reverse the DC power cable polarity. This could damage the transceiver.
- **BE SURE** to use a 12 V or 24 V battery, depending on the transceiver version.

DC power cable connection

NOTE: Use terminals for the cable connection.

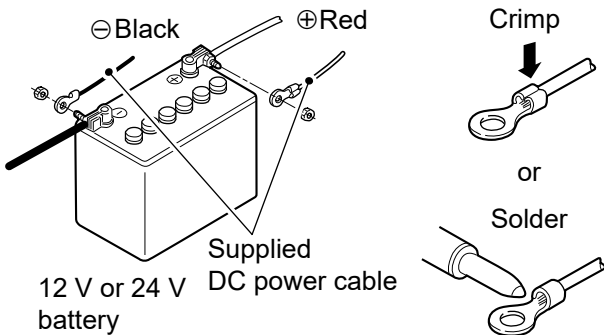

Attaching the weatherproof cap

Attach the supplied weatherproof cap for each positive and negative line at the DC power terminal, as shown below.

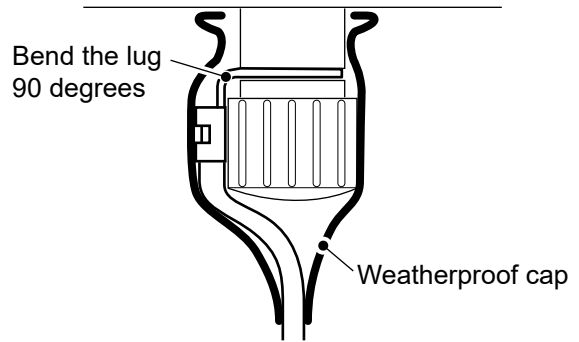

Attaching the Ferrite EMI filter

Connect the DC power cables to the transceiver's main unit through the supplied Ferrite EMI filter, as shown below.

NOTE: Place the Ferrite EMI filter as close to the main unit as possible.

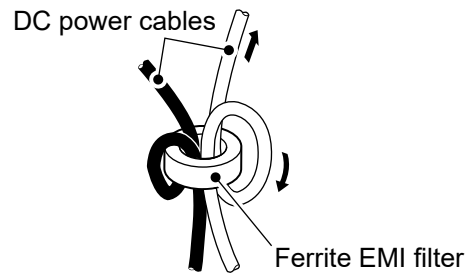

Antenna

Most stations operate with a whip or long wire antenna. However, these antennas cannot be connected directly to the transceiver because their impedance may not match the transceiver antenna connector.

For details about antenna connections and installation, see the supplied AT-141 Instruction manual.

⚠ DANGER HIGH RF VOLTAGE! NEVER touch an antenna while transmitting. It may result in an electrical shock or burn.

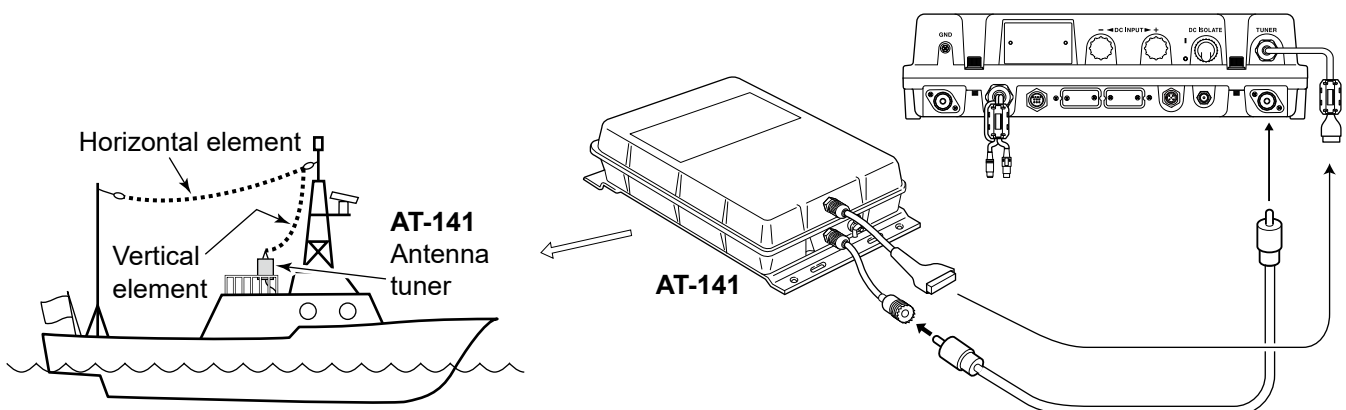

■ Mounting

◇ Mounting location

Select a location that provides easy access to the remote controller for navigation safety, has proper ventilation, and is not subject to sea spray. The remote controller should be in your line of sight when operating it.

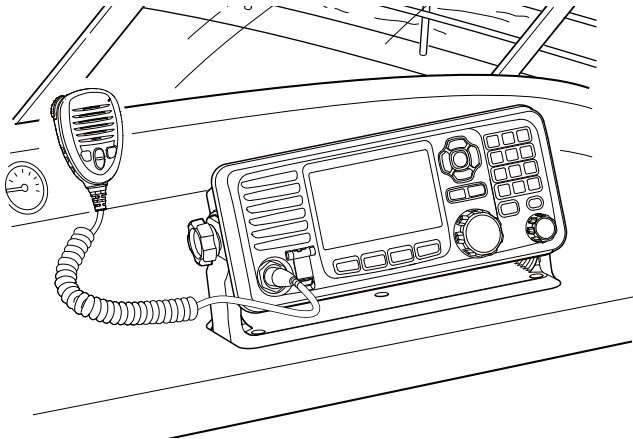





CAUTION: KEEP the transceiver and microphone at least 1 meter away from your vessel's magnetic navigation compass.

NOTE:

- Turn OFF [DC ISOLATE] on the Main unit when mounting the transceiver.
- Place the supplied Emergency frequency sticker to where it always be visible when operating the transceiver.

■ Emergency frequency list			
	Radiotelephone(User CH)	DSC(Digital Selective Calling)	Radiotelex
MF	2182kHz (CH 1)	2187.5kHz	2174.5kHz
HF4	4125kHz (CH 2)	4207.5kHz	4177.5kHz
HF6	6215kHz (CH 3)	6312.0kHz	6268.0kHz
HF8	8291kHz (CH 4)	8414.5kHz	8376.5kHz
HF12	12290kHz (CH 5)	12577.0kHz	12520.0kHz
HF16	16420kHz (CH 6)	16804.5kHz	16695.0kHz

■ Emergency operation	
Sending a Distress call	Sending a Distress Cancel call
1. Lift up the key cover of [DISTRESS]. 2. Hold down [DISTRESS] for 3 seconds to send the Distress call.	1. When "Waiting for Distress ACK" is displayed, push [Cancel]  . 2. Push [Continue]  to send the Distress Cancel call.

■ DSC call operation	
1. Push [Compose Distress] or [Compose Other]  and enter the required information. 2. Push [Call]  to transmit a DSC call.	

◇ Mounting the remote controller

You can mount the remote controller on a dashboard using the mounting bracket supplied with the transceiver.

1. Securely mount the bracket to a more than 10 mm thick surface that supports more than 2 kg, using the 5 supplied screws (5 × 20 mm).
2. Attach the remote controller to the bracket so that the face of the remote controller is in your line of sight when operating it.
 - ① Adjust the function display angle to be easy to read.
3. Attach the supplied knobs to both sides of the remote controller.

Mounting Example

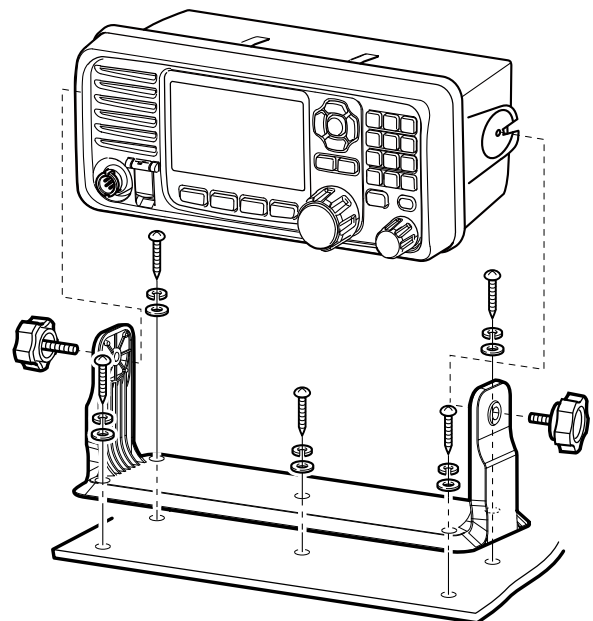

■ Mounting

◇ Mounting the main unit

You can mount the Main unit using the supplied mounting plates.

⚠ WARNING! NEVER mount the transceiver's Main unit overhead. The weight of the Main unit is approximately 8.6 kg, and it could easily fall due to wave shocks or vibration. The unit must be mounted on a flat hard surface only.

1. Attach the supplied rubber feet to the mounting plates, if necessary.

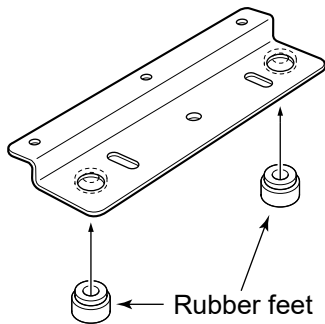

2. Attach the mounting plates to the Main unit using the 6 supplied hex head bolts (6 × 15 mm), 6 flat and spring washers, as shown below.

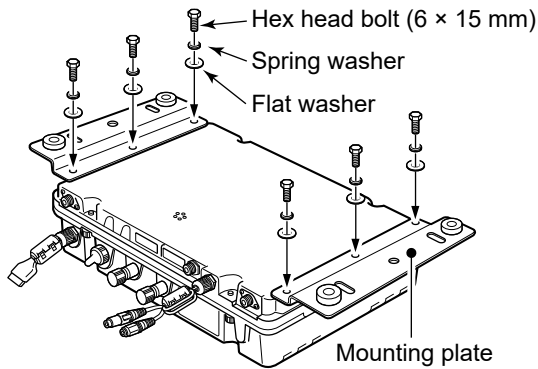

3. Securely mount the Main unit to a surface, which is less than 25 mm thick and can support more than 15 kg.
4. Attach the 6 supplied hex head bolts (6 × 50 mm), 12 flat and spring washers, and 6 nuts, as shown below. (Torque: 3 N•m)

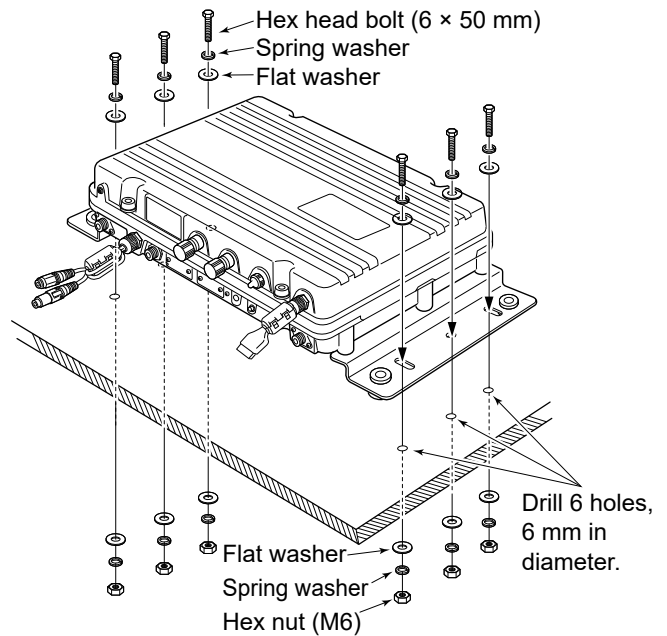

■ MB-75 installation

The optional MB-75 FLUSH MOUNT KIT is for mounting the remote controller to a flat surface (less than 18 mm thick), such as an instrument panel.

1. Using the template on page 76, carefully cut a hole in the instrument panel or wherever you plan to mount the remote controller.
2. Slide the remote controller into the hole, as shown to the right.

CAUTION: KEEP the transceiver and microphone at least 1 meter away from your vessel's magnetic navigation compass.

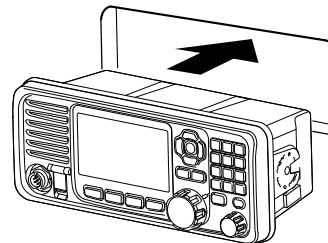

3. Attach the 2 bolts (5 × 8 mm) and spacers supplied with the MB-75 to both sides of the remote controller.

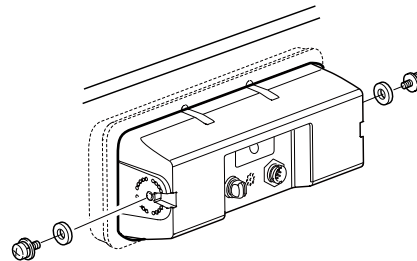

4. Attach the clamps on both sides of the remote controller.
 - ① Make sure that the clamps align parallel to the transceiver's body.

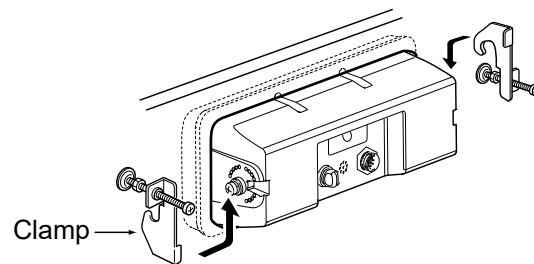

5. Tighten the end bolts on the clamps (rotate clockwise) so that the clamps firmly press against the inside of the instrument control panel.

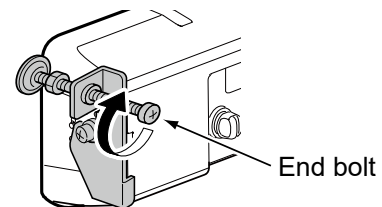

6. Tighten the locking nuts (rotate counterclockwise) so that the remote controller is securely mounted in position, as shown to the right.

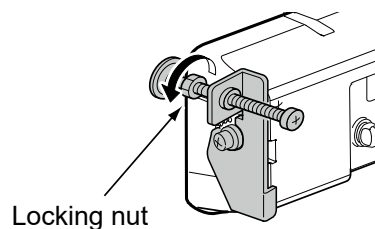

7. Connect the remote control cable.

■ MB-108 installation

The optional MB-108 MOUNTING BRACKET is for mounting the Main unit to a flat surface (less than 25 mm thick and can support more than 15 kg), such as an instrument panel.

The MB-108 provides a one-touch attachment or detachment.

1. Attach the mounting handles with the 6 supplied hex head bolts (6 × 15 mm), 6 spring and flat washers, as shown below.

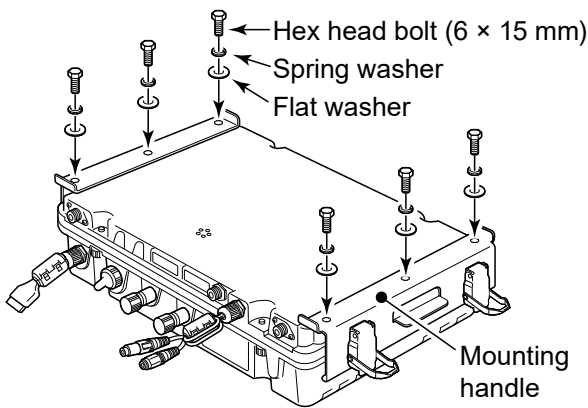

2. Drill 7 holes, 6 ~ 8 mm in diameter, using the template supplied with the MB-108.
3. Attach the mounting base to a flat surface using the 7 hex head bolts (6 × 50 mm), 14 spring and flat washers, and 7 nuts supplied with the MB-108, as shown below. (Torque: 3 N•m)

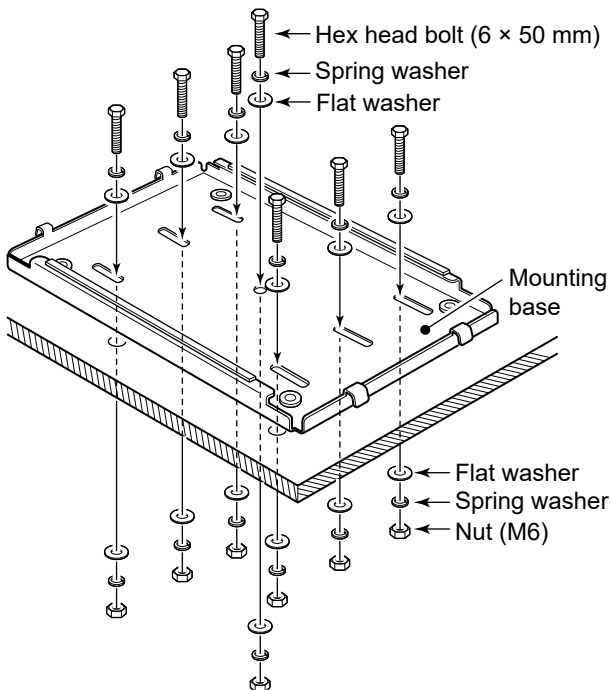

CAUTION: KEEP the transceiver and microphone at least 1 meter away from your vessel's magnetic navigation compass.

CAUTION: Wear gloves when installing the MB-108. The edges of the MB-108 may be sharp and may cut your fingers or hands.

4. Mount the Main unit with the mounting handles attached to the mounting base.

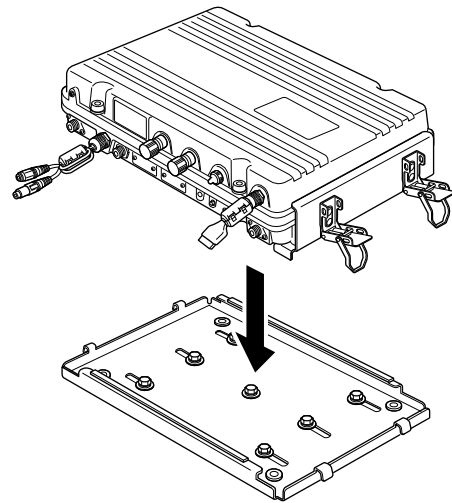

5. Lock the Main unit in place by closing the 4 latches on the mounting handles.

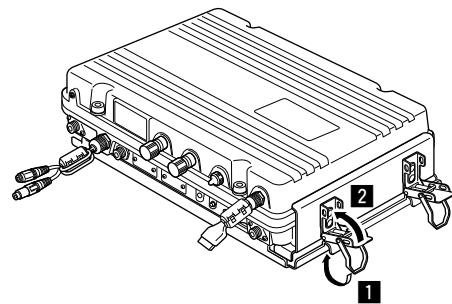

■ Fuse replacement

The transceiver has 2 fuses to protect internal circuitry. If the transceiver stops functioning, and only after confirming a fuse is probably blown, check the fuses below.

- DC-DC converter unit: APS 58 V 5 A
- PA unit: APS 58 V 5 A

CAUTION: Disconnect the DC power cable from the transceiver before replacing a fuse.

1. Unscrew the 4 cap bolts from the top case with a 6 mm Allen wrench.

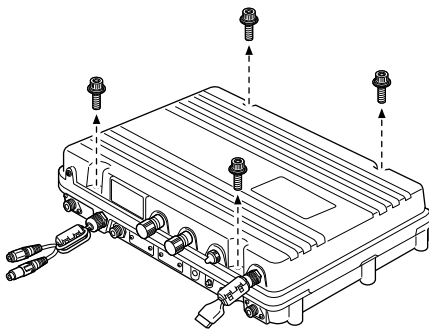

2. Open the Main unit, and then disconnect 1 flat and 2 coaxial cables, as shown below.

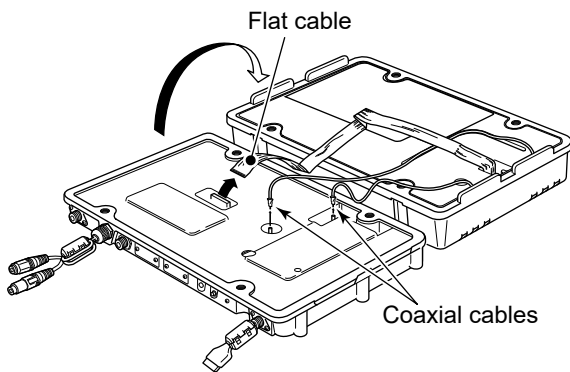

3. Unscrew the 26 screws from the shield covers, and then open the covers.

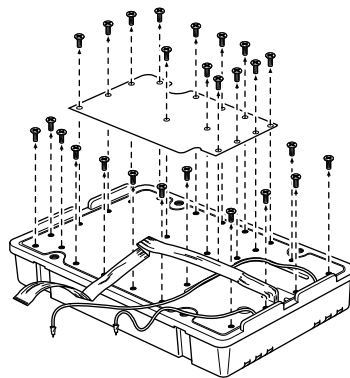

CAUTION: Disconnect the DC power cable from the transceiver before replacing a fuse.

4. Replace the circuitry fuses, as shown below.

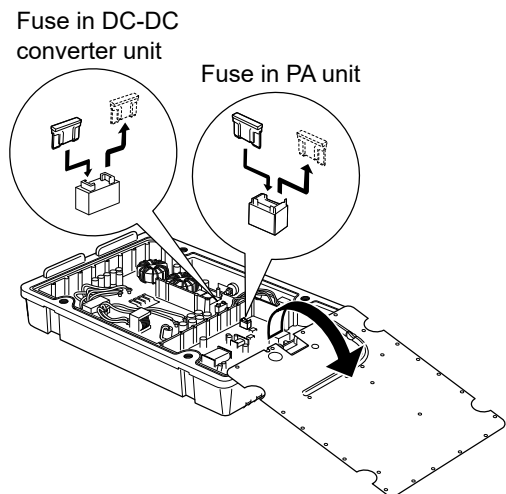

CAUTION: When removing a fuse, use longnose pliers to protect your fingers and the fuse holders.

5. Replace the shield covers, flat cable, coaxial cables, and top case to their original locations.

■ Connector information

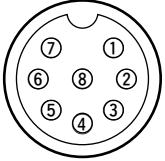
MICROPHONE	Pin	Pin name	Description	Specification
	1	MIC+	Audio input from the microphone element.	Input impedance: 1.74 kΩ ± 20%
	2	MIC SW	Key detection.	–
	3	AF1	AF output controlled with [VOL]. Connected to pin 4 in the microphone.	–
	4	AF2	AF input. Connected to pin 3 in the microphone.	–
	5	PTT	PTT switch input. When GND, transmits.	–
	6	GND	Connected to ground.	–
	7	MIC–	Coaxial ground for MIC+.	–
	8	AF–	Coaxial ground for AF1 and AF2.	–

GPS-DATA	Pin	Pin name	Description
	1	NMEA+	NMEA 0183 ver 4.10 data input (+).
	2	NMEA–	Ground for NMEA data (-).

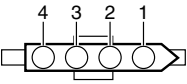
TUNER	Pin	Pin name	Description	Specification
	1	KEY	Key signal input.	–0.5 to 0.8 V during tuning.
	2	START	Start/Through signal output.	Pulled up 8 V, 0 V (100 msec) as a start signal.
	3	13.6 V	13.6 V output.	Maximum current: 2 A
	4	ANTC	Antenna current detector output.	–

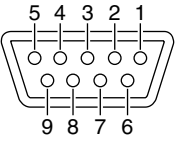
AF/MOD	Pin	Pin name	Description	Specification
	1	MOD+	Modulation input from an external terminal unit.	Input impedance: More than 600 Ω Input level: Approximately 250 mV rms
	2	MOD–	Coaxial ground for MOD+.	Input impedance: More than 600 Ω
	3	AF+	AF detector output for an external terminal unit.	Output impedance: Less than 600 Ω Output level: More than 770 mV rms
	4	AF–	Coaxial ground for AF+.	Output impedance: Less than 600 Ω
	5	SEND	Ground this pin to transmit.	Ground level: –0.5 ~ 0.8 V Input current: Less than 20 mA
	6	CWK	Input/output pin. Goes to GND when transmitting.	–
	7	13.6 V	13.6 V output when power is ON.	Maximum current: 1 A
	8	ALC	ALC voltage input.	Input impedance: More than 1 Ω
	9	GND	Ground for digital equipment.	–

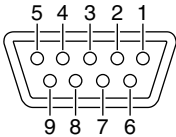
REMOTE	Pin	RS-232C	Description
		NMEA	
	1	DCD	Input terminal for carrier detection.
		NMEA-IN-	NMEA 0183 ver 4.10 data input (-).
	2	RXD	Input terminal for receive data.
		NMEA-IN+	NMEA 0183 ver 4.10 data input (+).
	3	TXD	Outputs transmit data.
		NMEA-OUT+	NMEA 0183 ver 4.10 data output (+).
	4	DTR	Outputs a data terminal ready signal.
		NMEA-OUT-	NMEA 0183 ver 4.10 data output (-).
	5	GND	Connected to ground.
	6	DSR	Input terminal for a data-set-ready signal.
		NC	No connection.
	7	RTS	Outputs request-to-send data.
		NC	No connection.
	8	CTS	Input terminal for clear-to-send data.
		NC	No connection.
	9	NC	No connection.

8

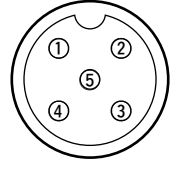
NMEA 2000	Pin	Pin name
	1	NC
	2	NET-S
	3	NET-C
	4	NET-H
	5	NET-L

■ Specifications

◇ General

- Frequency coverage:

RX	0.5 ~ 29.9999 MHz (Continuously)
TX	1.6 ~ 2.9999 MHz, 4.0 ~ 4.9999 MHz, 6.0 ~ 6.9999 MHz, 8.0 ~ 8.9999 MHz, 12.0 ~ 13.9999 MHz, 16.0 ~ 17.9999 MHz, 18.0 ~ 19.9999 MHz, 22.0 ~ 22.9999 MHz, 25.0 ~ 27.5000 MHz
- DSC (RX): 2.1875 MHz, 4.2075 MHz, 6.3120 MHz,
8.4145 MHz, 12.5770 MHz, 16.8045 MHz
- Mode:

RX/TX	J3E (USB), J2B (AFSK), F1B (FSK)
RX only	J3E (LSB), A1A (CW), H3E (AM)
DSC	F1B
- The number of channels:

User channels	160
ITU SSB simplex channels	72
ITU SSB duplex channels	249
ITU FSK channels	193
- Antenna connector:

SO-239 × 2

- Antenna impedance:

50 Ω (Unbalanced)

- Frequency stability:

Transceiver	±10 Hz
DSC	±10 Hz
- Power supply requirement:

DC 12 V	10.8 ~ 15.6 V (negative ground)
DC 24 V	21.6 ~ 31.2 V (negative ground)
- Current drain:

RX	Less than 6.0 A (12 V), Less than 3.0 A (24 V) (at maximum audio output)
TX	Less than 40 A (12 V), Less than 20 A (24 V) (at maximum output power, with 1.1 kHz and 1.7 kHz AF inputs)
- Usable temperature range: -15°C ~ +55°C
- Dimensions (projections not included):

Main unit	367 (W) × 95 (H) × 260 (D) mm,
Controller	274 (W) × 114 (H) × 86 (D) mm
- Weight (approximate):

Main unit	8.6 kg
Controller	760 g

NOTE: The usable temperature range of the AT-141 ANTENNA TUNERS is different from the IC-M804. The range is -20°C ~ +55°C.

◇ Transmitter

- Output power (At the tuner output):

1.6 ~ 3.9999 MHz	85 W PEP
4.0 ~ 27.5000 MHz	125 W PEP
- Spurious emissions (at maximum power):

Less than -50 dB for peak output power
--
- Carrier suppression (at maximum power):

More than 40 dB for peak output power

- Unwanted sideband suppression (at maximum power):

More than 55 dB for peak output power (with 1500 Hz AF Input)
--

◇ Receiver

- Sensitivity:

RX	
J3E, A1A	0.5 ~ 1.5999 MHz 30 dBμV emf (20 dB SINAD)
	1.6 ~ 29.9999 MHz 8 dBμV emf (20 dB SINAD)
J2B, F1B	1.6 ~ 29.9999 MHz 0 dBμV emf (at 1% error rate)
H3E	0.5 ~ 1.5999 MHz 44 dBμV emf (20 dB SINAD)
	1.6 ~ 3.9999 MHz 24 dBμV emf (20 dB SINAD)
DSC (RX)	0 dBμV emf (at 1% error rate)
- Squelch sensitivity (S-meter):

J3E (at 12.230 MHz)	
Less than +26 dBμV emf (threshold)	
Less than +96 dBμV emf (tight)	
H3E (at 1.000 MHz)	
Less than +36 dBμV emf (threshold)	
Less than +116 dBμV emf (tight)	
- Spurious response rejection:

J3E	More than 60 dB (1.6 ~ 29.9999 MHz)
DSC	More than 90 dBμV emf
- CLARITY variable range: ±150 Hz

① All stated specifications are subject to change without notice or obligation.

■ Transceiver dimensions

Unit: mm

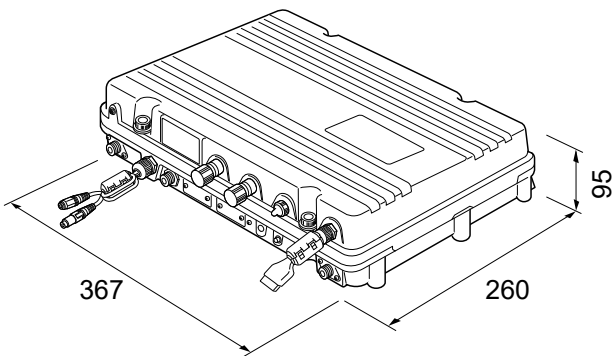
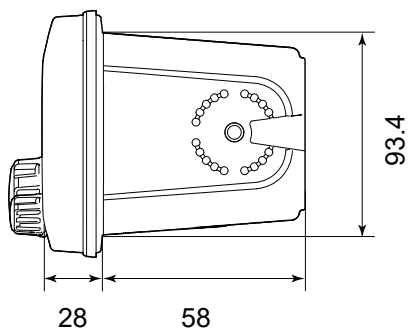
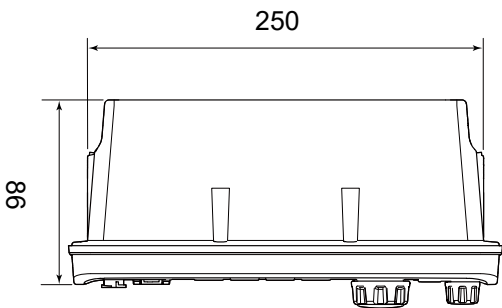
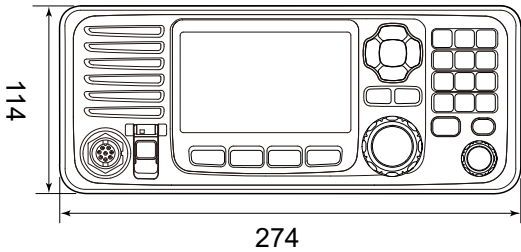

■ Options

◇ Antenna tuner

- **AT-141** AUTOMATIC ANTENNA TUNER
Matches the transceiver to a long wire antenna with little insertion loss.

◇ Microphone

- **HM-214H** MICROPHONE
IPX8 waterproof, dynamic microphone. Same as supplied.

◇ Others

- **SP-24E** EXTERNAL SPEAKER
4×4 inch external speaker. Input impedance: 4 Ω. Maximum input power: 7 W.
- **HS-98** HANDSET
- **MB-75** FLUSH MOUNT KIT
To mount the controller or SP-24E EXTERNAL SPEAKER to a panel.
- **MB-108** MOUNTING BRACKET
To mount the Main unit.
- **OPC-1465** SHIELDED CONTROL CABLE
10 meters shielded control cable connects the AT-141 to the transceiver.
- **CS-M804** PROGRAMMING SOFTWARE
- **OPC-478UC** PROGRAMMING CABLE

10 TROUBLESHOOTING

The transceiver does not turn ON.

- There is a bad connection to the power supply.
→Check the connection between the transceiver and the power supply. (p. 65)
- The fuse is blown.
→Repair the problem, and then replace the fuse. (p. 70)

Little or no sound comes from the speaker.

- The squelch level is set too high.
→Set the squelch (S-meter Squelch level) to the threshold point. (p. 14)
- The volume level is set too low.
→Set the volume level to a suitable level. (p. 3)

You cannot transmit.

- Some channels are set for receive only by regulations.
→Change channels. (p. 9)

No beep sounds.

- The Key Beep function is OFF.
→Turn ON the function. (p. 56)

The Main screen is not displayed at power ON.

- The MMSI (DSC self ID) code is not set
→Set the MMSI (DSC self ID) code. (p. 8)

Individual or Group ID cannot be set.

- The entered ID code is incorrect. The first digit must be set to between '1' and '9' for an Individual ID.
→Enter a correct ID code. (p. 20)

“??” blinks instead of the position and time.

- Four hours have passed since the position data was manually entered.
→Re-enter the position and time.
- The GPS signal is not correctly received.
→Manually enter the position and time. (p. 22)

“No Position” and “No Time” are displayed instead of the position and time.

- The GPS antenna is not correctly connected.
→Make sure the GPS antenna is located where it has a clear view to receive a signal from satellites. (p. 63)
→Check the cable connection to GPS-DATA or GPS-ANT. (pp. 63, 71)
- The position and time have not been manually entered.
→Manually enter the position and time. (p. 22)

Sensitivity is too low, and only strong signals can be heard.

- The antenna is defective, or the coaxial cable connector is shorted or cut.
→Repair the problem, and then reconnect the antenna connector. (p. 62, 65)

Communication cannot be established.

- The antenna is defective, or the coaxial cable connector is shorted or cut.
→Repair the problem, and then reconnect the antenna connector. (p. 62, 65)

“The transceiver cannot receive or transmit. Contact your dealer” is displayed.

- The transceiver's Phase Lock Loop is unlocked.
→Contact your dealer.

The transceiver is locked up and does not respond.

- A software error has occurred.
→The transceiver will automatically restart after approximately 10 seconds have passed.

Cut here

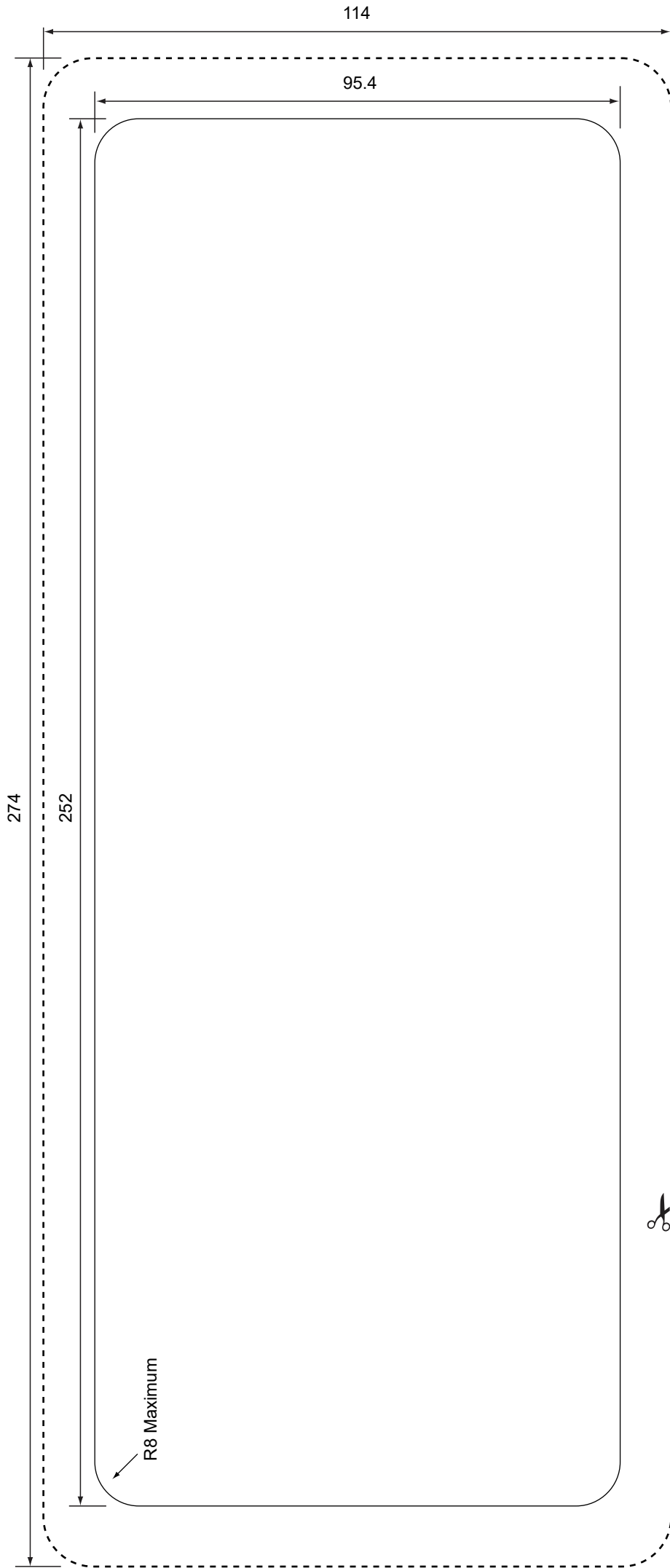

Unit: mm

A		E	
Accessories	61	Emergency FREQ channel.....	14
Alarm Status (DSC Settings).....	51	External Tuner (Radio Settings)	58
Antenna	65	F	
AT-141	62	Ferrite EMI filter	65
Auto ACK (DSC Settings).....	49	FSK operation.....	11
Automatic Gain Control OFF	15	FSK (Radio Settings).....	59
Auto Tune (Radio Settings)	58	Function display	
B		Channel area.....	6
Backlight		Information area	6
Configuration	56	Position and Time area.....	7
Function.....	12	Software key area	7
C		Status area	6
Channel		Task area.....	6
Edit	17	Fuse replacement	
Group	9	Circuitry fuse	70
List.....	9	G	
Selecting.....	9	Geographical Area call	
CH Auto Switch (DSC Settings).....	50	Receiving.....	44
Clarity Control function	14	Sending	33
Connections		GPS (Configuration)	57
FSK terminal unit.....	11	Ground connection	64
Main unit.....	62	Group call	
Remote control cable	64	Receiving.....	44
Connector information	71	Sending	31
D		Group ID	
Distress Acknowledgment		Deleting	21
Receiving.....	38	Entering	20
Distress call		I	
Receiving.....	39	IF Filter (Radio Settings).....	59
Regular call	25	Indicators	6
Resending call	26	Individual Acknowledgment	
Simple call	24	Receiving.....	44
Distress Cancel call		Sending	30
Receiving.....	39	Individual call	
Sending	27	Receiving.....	43
Distress key	3	Sending	29
Distress Relay Acknowledgment		Individual ID	
Receiving.....	40	Deleting	21
Distress Relay call		Entering	20
Receiving.....	40	Instant Replay	
DSC		Function.....	12
About	20	Radio Settings	60
Address ID.....	20	ITU Simplex channel	
Frequency	47	Editing	17
Log, received.....	46		
Log, transmitted.....	46		
Settings	47		
DSC Scan.....	10		
DSC Task mode.....	23		
DSC watch mode.....	10		

INDEX

M		R	
Main screen	6	Radio Information	60
Main unit		Receiving	10
Panel description	2	Remote (Configuration)	57
Max User CH (Radio Settings)	58	Remote controller	
MB-75 installation	68	Panel description	3
MB-108 installation	69	RF Gain Level	14
Menu screen		S	
About	53	Scan	
Construction	54	CH	13
Selecting the item	53	CH Resume	13
Microphone	4	Program	13
Assigning	19	Radio Settings	59
Connecting	63	Scanning Receiver (DSC Settings)	
MMSI code		Distress	48
Entering	8	Routine	49
Mounting		Self Check Test (DSC Settings)	52
Location	66	S-meter Squelch Level	14
Main unit	67	Software Keys	
Remote controller	66	Assigning	18
N		Functions	5
NMEA 0183		Selecting	4
Connection	63	Speaker Output	15
Connector	72	Specifications	73
NMEA 2000		Squelch function	14
Compatible PGN list	58	T	
Configuration	57	Temporary Operating Frequency	16
Connection	63	Test Acknowledgment	
Connector	71	Receiving	45
NMEA Data Output (DSC Settings)	50	Sending	37
Noise Blanker function	14	Test call	
Noise Blanker Level	14	Receiving	45
Noise Reduction (Radio Settings)	58	Sending	36
O		Time-out Timer function	10
Operating rules	1	Transceiver dimensions	74
Options	74	Transmit Frequency Monitor function	15
P		Transmitting	10
Position		Tune key	3
Entering	22	TX Meter (Radio Settings)	58
Input (DSC Settings)	47	U	
Position Request call		User channel	
Receiving	44	Editing	17
Position Request Acknowledgment		V	
Sending	35	Voice SQL (Radio Settings)	59
Power key	3	Volume Dial	
Power source	65	Assigning	19
Programmable key		Function	3
Assigning	19		

A series of horizontal dotted lines for writing, spanning the width of the page.

A series of horizontal dotted lines for writing.

