

KENWOOD

TK-7160/ TK-8160
TK-7162/ TK-8162

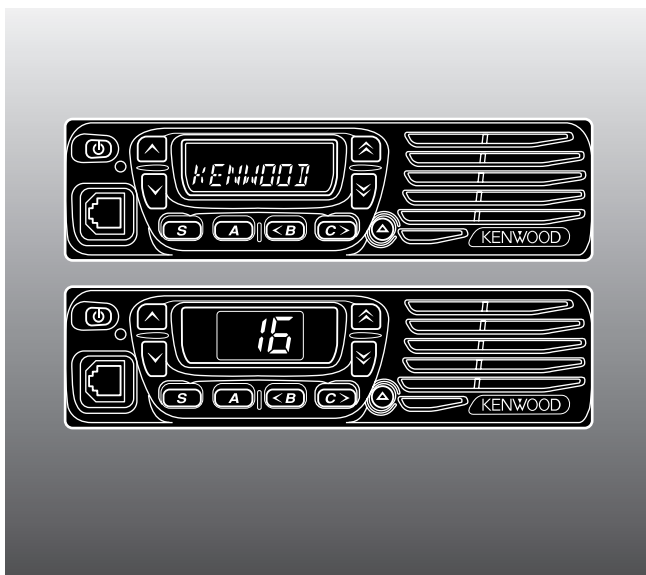

VHF FM TRANSCEIVER/ UHF FM TRANSCEIVER

INSTRUCTION MANUAL

ÉMETTEUR-RÉCEPTEUR FM VHF/ ÉMETTEUR-RÉCEPTEUR FM UHF

MODE D'EMPLOI

TRANSCPTOR FM VHF/ TRANSCPTOR FM UHF

MANUAL DE INSTRUCCIONES

RICETRASMETTITORE FM VHF/ RICETRASMETTITORE FM UHF

MANUALE DI ISTRUZIONI

VHF-FM-TRANSCEIVER/ UHF-FM-TRANSCEIVER

BEDIENUNGSANLEITUNG

VHF FM ZENDONTVANGER/ UHF FM ZENDONTVANGER

GEBRUIKSAANWIJZING

KENWOOD CORPORATION

© B62-1863-00 (E, E3, X2)
09 08 07 06 05 04 03 02 01 00

VHF FM TRANSCEIVER/
UHF FM TRANSCEIVER

TK-7160/ TK-8160

TK-7162/ TK-8162

INSTRUCTION MANUAL

KENWOOD CORPORATION

ENGLISH

THANK YOU

We are grateful you have chosen **KENWOOD** for your personal mobile applications. We believe this easy-to-use transceiver will provide dependable communications to keep personnel operating at peak efficiency.

KENWOOD transceivers incorporate the latest in advanced technology. As a result, we feel strongly that you will be pleased with the quality and features of this product.

MODELS COVERED BY THIS MANUAL

The models listed below are covered by this manual:

- **TK-7160:** VHF FM Transceiver
- **TK-7162:** VHF FM Transceiver
- **TK-8160:** UHF FM Transceiver
- **TK-8162:** UHF FM Transceiver

NOTICES TO THE USER

- ◆ Government law prohibits the operation of unlicensed transmitters within the territories under government control.
- ◆ Illegal operation is punishable by fine and/or imprisonment.
- ◆ Refer service to qualified technicians only.

SAFETY: It is important that the operator is aware of, and understands, hazards common to the operation of any transceiver.



WARNING

- ◆ **EXPLOSIVE ATMOSPHERES (GASES, DUST, FUMES, etc.)**
Turn OFF your transceiver while taking on fuel or while parked in gasoline service stations. Do not carry spare fuel containers in the trunk of your vehicle if your transceiver is mounted in the trunk area.
- ◆ **INJURY FROM RADIO FREQUENCY TRANSMISSIONS**
Do not operate your transceiver when somebody is either touching the antenna or standing within 2 to 3 feet (60 to 90 cm) of it, to avoid the possibility of radio frequency burns or related physical injury.
- ◆ **DYNAMITE BLASTING CAPS**
Operating the transceiver within 500 feet (150 m) of dynamite blasting caps may cause them to explode. Turn OFF your transceiver when in an area where blasting is in progress, or where "TURN OFF TWO-WAY RADIO" signs have been posted. If you are transporting blasting caps in your vehicle, make sure they are carried in a closed metal box with a padded interior. Do not transmit while the caps are being placed into or removed from the container.

PRECAUTIONS

Observe the following precautions to prevent fire, personal injury, and transceiver damage.

- Do not attempt to configure the transceiver while driving; it is too dangerous.
- Do not disassemble or modify the transceiver for any reason.
- Do not expose the transceiver to long periods of direct sunlight, nor place it near heating appliances.
- If an abnormal odor or smoke is detected coming from the transceiver, switch the transceiver power off immediately, and contact your **KENWOOD** dealer.
- Use of the transceiver while you are driving may be against traffic laws. Please check and observe the vehicle regulations in your area.
- Do not use options not specified by **KENWOOD**.



CAUTION

- ◆ The transceiver operates in 12 V negative ground systems only! Check the battery polarity and voltage of the vehicle before installing the transceiver.
- ◆ Use only the supplied DC power cable or a **KENWOOD** optional DC power cable.
- ◆ Do not cut and/or remove the fuse holder on the DC power cable.



WARNING

For passenger safety, install the transceiver securely using the supplied mounting bracket and screw set so the transceiver will not break loose in the event of a collision.

CONTENTS

UNPACKING AND CHECKING EQUIPMENT	1
SUPPLIED ACCESSORIES	1
PREPARATION	2
TOOLS REQUIRED	2
POWER CABLE CONNECTION	2
INSTALLING THE TRANSCEIVER	3
CONNECTING A MICROPHONE	4
GETTING ACQUAINTED	5
FRONT PANEL	5
DISPLAY (TK-7160/ TK-8160)	6
DISPLAY (TK-7162/ TK-8162)	7
REAR PANEL	8
PROGRAMMABLE FUNCTIONS	9
BASIC OPERATIONS	10
SWITCHING POWER ON/ OFF	10
ADJUSTING THE VOLUME	10
SELECTING A ZONE AND CHANNEL	11
TRANSMITTING	11
RECEIVING	11
SCAN	12
PRIORITY SCAN	12
ADD TO SCAN/ DELETE FROM SCAN	13
REVERT CHANNEL	13
DTMF CALLS	14
STORE & SEND (TK-7160/ TK-8160 ONLY)	14
MANUAL DIALING	14
STORING DTMF NUMBERS	14
DIALING STORED DTMF NUMBERS	15
CLEARING STORED DTMF NUMBERS	15
REDIALING	15
STUN	15

QUIET TALK (QT)/ DIGITAL QUIET TALK (DQT)	16
OPERATOR SELECTABLE TONE (OST) (TK-7160/ TK-8160 ONLY)	16
CODE SQUELCH (ID CODE)	17
RECEIVING	17
TRANSMITTING	17
SELECTIVE CALL (TK-7160/ TK-8160 ONLY)	18
RECEIVING	18
TRANSMITTING	18
FleetSync: ALPHANUMERIC 2-WAY PAGING SYSTEM	19
SELCALL (SELECTIVE CALLING)	19
STATUS MESSAGE (TK-7160/ TK-8160 ONLY)	20
GPS REPORT (TK-7160/ TK-8160 ONLY)	21
5-TONE SIGNALING	22
My ID	22
MAKING A SELCALL (SELECTIVE CALLING) (TK-7160/ TK-8160 ONLY)	22
RECEIVING A SELCALL	23
EMERGENCY OPERATION	24
LONE WORKER MODE	24
ADVANCED OPERATIONS	25
TALK AROUND	25
KEY LOCK	25
AUXILIARY PORT	25
HORN ALERT	25
DISPLAY BRIGHTNESS (TK-7160/ TK-8160 ONLY)	26
DIRECT CHANNEL	26
MONITOR/ SQUELCH OFF	26
VOICE SCRAMBLER	27
BACKGROUND OPERATIONS	28
TIME-OUT TIMER (TOT)	28
BUSY CHANNEL LOCKOUT (BCL)	28
BEGINNING/ END OF TRANSMIT SIGNAL	28
DTMF NUMBER DISPLAY (TK-7160/ TK-8160 ONLY)	28

UNPACKING AND CHECKING EQUIPMENT

Note: The following unpacking instructions are for use by your **KENWOOD** dealer, an authorized **KENWOOD** service facility, or the factory.

Carefully unpack the transceiver. We recommend that you identify the items listed in the following table before discarding the packing material. If any items are missing or have been damaged during shipment, file a claim with the carrier immediately.

SUPPLIED ACCESSORIES

Item	Part Number	Quantity
DC power cable (with fuses) (E, E3 types only) • 10 A fuse	E30-7523-XX	1
	F52-0023-XX	2
DC power cable (with fuses) (X2 type only) • 10 A fuse	E30-3339-XX	1
	F51-0016-XX	2
Mounting bracket	J29-0662-XX	1
Screw set: • Self-tapping screw (4 pieces) • Hex-headed screw with washer (4 pieces) • Spring washer (4 pieces) • Flat washer (4 pieces)	N99-0395-XX	1
Instruction manual	B62-1863-XX	1

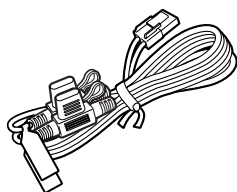

DC power cable (with fuses)
(E, E3 types only)

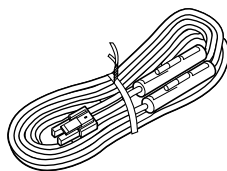

DC power cable (with fuses)
(X2 type only)

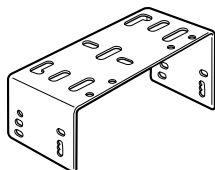

Mounting bracket

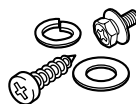

Screw set

PREPARATION



WARNING

Various electronic equipment in your vehicle may malfunction if they are not properly protected from the radio frequency energy which is present while transmitting. Electronic fuel injection, anti-skid braking, and cruise control systems are typical examples of equipment that may malfunction. If your vehicle contains such equipment, consult the dealer for the make of vehicle and enlist his/her aid in determining if they will perform normally while transmitting.

Note: The following preparation instructions are for use by your **KENWOOD** dealer, an authorized **KENWOOD** service facility, or the factory.

TOOLS REQUIRED

Note: Before installing the transceiver, always check how far the mounting screws will extend below the mounting surface. When drilling mounting holes, be careful not to damage vehicle wiring or parts.

The following tools are required for installing the transceiver:

- 6 mm (1/4 inch) or larger electric drill
- 4.2 mm (5/32 inch) drill bit for the 5 x 16 mm self-tapping screws
- Circle cutters

POWER CABLE CONNECTION



CAUTION

The transceiver operates in **12 V** negative ground systems only! Check the battery polarity and voltage of the vehicle before installing the transceiver.

- 1** Check for an existing hole, conveniently located in the firewall, where the power cable can be passed through.
 - If no hole exists, use a circle cutter to drill the firewall, then install a rubber grommet.
- 2** Run the two power cable leads through the firewall and into the engine compartment, from the passenger compartment.
- 3** Connect the red lead to the positive (+) battery terminal and the black lead to the negative (-) battery terminal.
 - Locate the fuse as close to the battery as possible.
- 4** Coil the surplus cable and secure it with a retaining band.
 - Be sure to leave enough slack in the cables so the transceiver can be removed for servicing while keeping the power applied.

INSTALLING THE TRANSCEIVER



WARNING

For passenger safety, install the transceiver securely using the supplied mounting bracket and screw set, so the transceiver will not break loose in the event of a collision.

- 1 Mark the position of the holes in the dash by using the mounting bracket as a template. Drill the holes, then attach the mounting bracket using the supplied 5 x 16 mm self-tapping screws.
 - Be sure to mount the transceiver in a location where the controls are within easy reach of the user and where there is sufficient space at the rear of the transceiver for cable connections.
- 2 Connect the antenna and the supplied power cable to the transceiver.
- 3 Slide the transceiver into the mounting bracket and secure it using the supplied hex-headed screws.
- 4 Mount the microphone hanger in a location where it will be within easy reach of the user.
 - The microphone and microphone cable should be mounted in a place where they will not interfere with the safe operation of the vehicle.



CAUTION

When replacing the fuse in the DC power cable, be sure to replace it with a fuse of the same value. Never replace a fuse with one that is rated with a higher value.

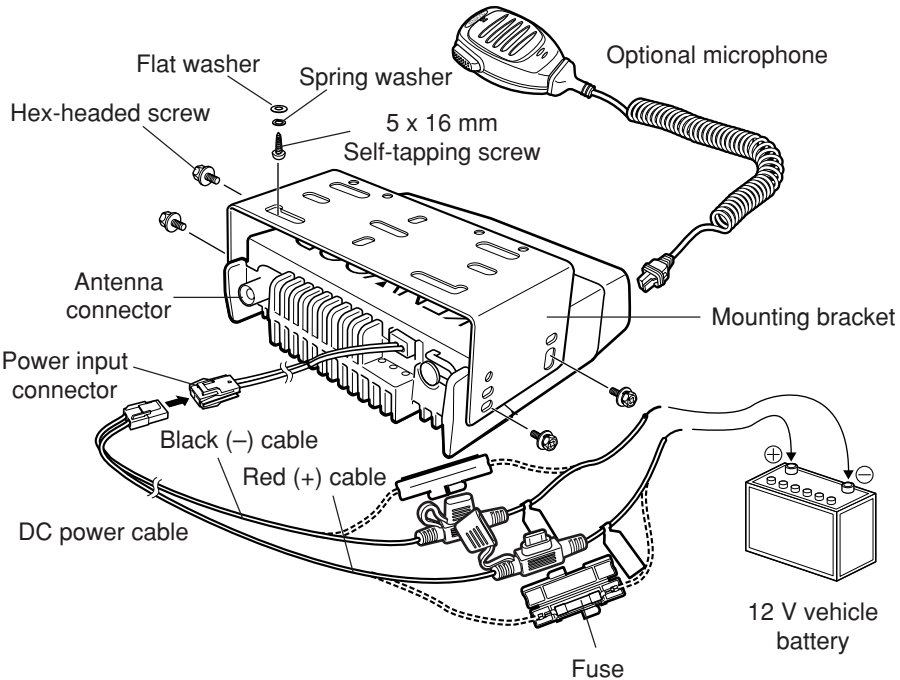

CONNECTING A MICROPHONE

- 1 Insert the microphone plug into the jack on the front panel of the transceiver.
 - Be sure the tab on the microphone plug is facing the left hand side.
- 2 Mount the microphone on the microphone hanger where it will be within easy reach of the user.
- 3 To remove the microphone plug, press the tab on the connector while pulling the plug out of the transceiver jack.

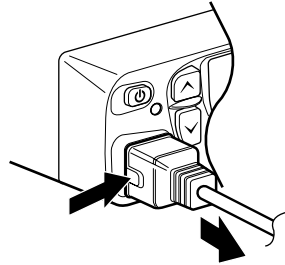
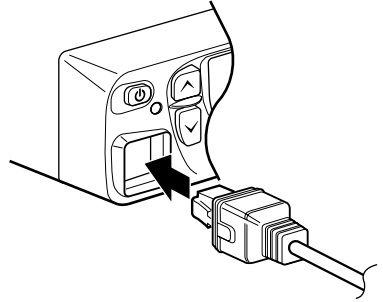

GETTING ACQUAINTED



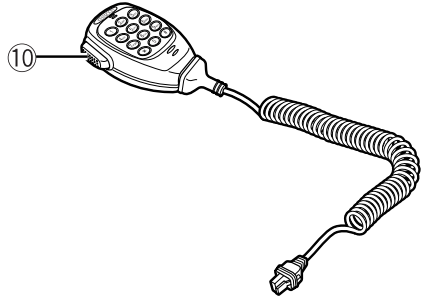
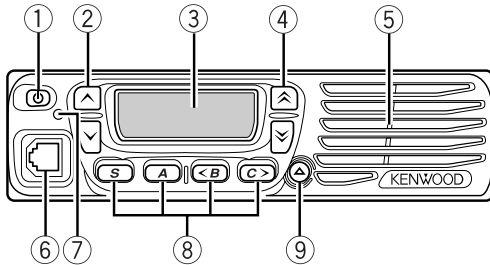





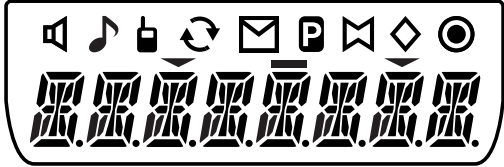



FRONT PANEL



- ① **⏻ (Power) switch**
Press to switch the transceiver ON or OFF.
- ② **^ / v keys**
Press to activate their programmable functions {page 9}.
- ③ **Display**
Refer to pages 6 and 7.
- ④ **^ / v keys**
Press to activate their programmable functions {page 9}.
- ⑤ **Speaker**
Internal speaker.
- ⑥ **Microphone jack**
Insert the microphone plug into this jack.
- ⑦ **TX/RX Indicator**
Lights red while transmitting. Lights green while receiving a signal.
- ⑧ **S, A, <B, and C> keys**
Press to activate their programmable functions {page 9}.
- ⑨ **Δ key**
Press to activate its programmable function {page 9}.
- ⑩ **PTT switch**
Press this switch, then speak into the microphone to call a station.







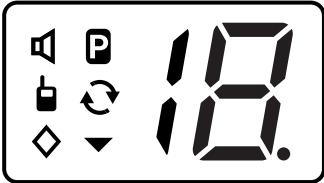

DISPLAY (TK-7160/ TK-8160)



Indicator	Description
	Appears when the key programmed as Monitor or Squelch Off is pressed.
	Appears when the DTMF code of a call matches the code in your transceiver.
	Appears while using the Talk Around function.
	The selected zone is added to the scanning sequence.
	Appears while scanning.
	Appears when a message is stored in the transceiver stack memory. Appears and blinks when a new message has arrived.
	Appears when the AUX port has been activated.
	The selected channel is set as a Priority channel.
	Appears when the Horn Alert function has been activated.
	The selected channel is added to the scanning sequence.
	Appears when Scrambler function has been selected.
	This icon is not used on this transceiver.
	Displays the currently selected zone and channel number, or the channel name.

DISPLAY (TK-7162/ TK-8162)



Indicator	Description
	Appears when the key programmed as Monitor or Squelch Off is pressed.
	Appears while using the Talk Around function.
	Appears when Scrambler function has been selected.
	The selected channel is set as a Priority channel.
	Appears while scanning.
	The selected channel is added to the scanning sequence.
	Displays the currently selected channel number (max 16 channels).
	Appears when the AUX port or Horn Alert function has been activated.

REAR PANEL

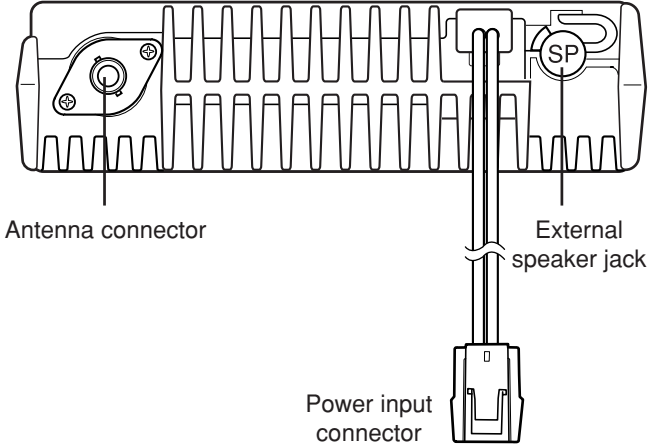

E, E3 Rear Panel

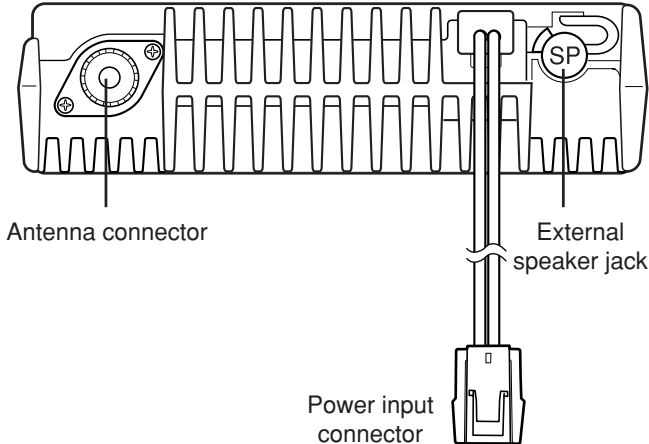

X2 Rear Panel

PROGRAMMABLE FUNCTIONS

The \wedge , \vee , $\hat{\wedge}$, $\hat{\vee}$, **S**, **A**, **<B**, **C>**, and \blacktriangle keys can be programmed with the functions listed below. Ask your dealer for details on these functions.

- AUX
- Call 1 ~ Call 2
- Channel Down
- Channel Up
- Digit 1x Down ¹
- Digit 10x Down ¹
- Digit 1x Up ¹
- Digit 10x Up ¹
- Direct CH ^{2,3}
- Direct Zone-Channel ^{1,3}
- Display Character ¹
- Emergency ⁴
- Horn Alert
- Key Lock
- LCD Brightness ¹
- Lone Worker
- Monitor
- None
- Operator Selectable Tone ¹
- Scan Del/Add
- Scan
- Scrambler
- Selcall ¹
- Selcall (5-tone) ¹
- Selcall + Status ¹
- Send the GPS data ¹
- Squelch Level
- Squelch Off
- Squelch Off Momentary
- Status ¹
- Talk Around
- Volume Down
- Volume Up
- Zone Down
- Zone Up

¹ Digit 1x Down, Digit 10x Down, Digit 1x Up, Digit 10x Up, Direct Zone-Channel, Display Character, LCD Brightness, Operator Selectable Tone, Selcall, Selcall (5-tone), Selcall + Status, Send the GPS data, and Status are available only on TK-7160/ TK-8160 transceivers.

² Direct CH is available only on TK-7162/ TK-8162 transceivers.

³ Direct CH and Direct Zone-Channel can be programmed only on the **S**, **A**, **<B**, **C>**, and \blacktriangle keys.

⁴ Emergency can be programmed only on the \blacktriangle key.

BASIC OPERATIONS

SWITCHING POWER ON/ OFF

Press the **⏻** switch to switch the transceiver ON.

- A beep sounds.
- If programmed, the TK-7160/ TK-8160 transceiver will momentarily display an 8-character power-on message.
- If the Transceiver Password function is programmed, “*PR551000*” (TK-7160/ TK-8160) or “*P*” (TK-7162/ TK-8162) will appear on the display when the power is turned ON. Refer to “Transceiver Password”, below.

Press the **⏻** switch again to switch the transceiver OFF.

■ Transceiver Password

To enter the password:

- 1 Press the **⤴** and **⤵** keys to select a digit.
- 2 Press the **C>** key to accept the entered digit and move to the next digit.
 - Press the **A** key to delete an incorrect character (TK-7160/ TK-8160). Press and hold the **A** key to delete all entered characters.
 - Repeat steps 1 and 2 to enter the entire password.
- 3 Press the **S** key to confirm the password.
 - If you enter an incorrect password, an error tone sounds and the transceiver remains locked.

To enter the password using an optional DTMF keypad:

- 1 Press the DTMF keys corresponding to the password digits.
 - Press the **A** or DTMF **#** key to delete an incorrect character (TK-7160/ TK-8160). Press and hold the **A** or DTMF **#** key to delete all entered characters.
- 2 Press the **S** or DTMF ***** key to confirm the password.
 - If you enter an incorrect password, an error tone sounds and the transceiver remains locked.

ADJUSTING THE VOLUME

Press the **Volume Up** key to increase the volume. Press the **Volume Down** key to decrease the volume.

If Squelch Off has been programmed onto a key, you can use that function to listen to background noise while adjusting the volume level.

SELECTING A ZONE AND CHANNEL

On TK-7160/ TK-8160 transceivers, select the desired zone using the keys programmed as **Zone Up** and **Zone Down**.

Select the desired channel using the keys programmed as **Channel Up** and **Channel Down**.

On TK-7160/ TK-8160 transceivers, names of up to 8 characters in length can be programmed for channels. To toggle the display between the channel name and the zone-channel number, press the key programmed as **Display Character**.

TRANSMITTING

- 1 Select your desired zone and channel (above).
 - In Voting, Voting with Signaling, and Free Channel Call zones, the channel is selected automatically.
- 2 In Conventional zones, press the key programmed as **Monitor** or **Squelch Off** to check whether or not the channel is free.
 - If the channel is busy, wait until it becomes free.
- 3 Press microphone **PTT** switch and speak into the microphone. Release the **PTT** switch to receive.
 - For best sound quality at the receiving station, hold the microphone approximately 1.5 inches (3 ~ 4 cm) from your mouth.
 - In Voting and Voting with Signaling zones, the transceiver will search for the closest repeater and transmit using that repeater's frequency.
 - In Free Channel Call zones, the transceiver will search for a free channel and will begin transmitting on that channel.

RECEIVING

- 1 Select your desired zone and channel (above).
 - Alternatively, in Conventional zones, you can activate the Scan function if desired.
 - In Voting and Voting with Signaling zones, the transceiver will automatically search for the strongest signal and receive on that frequency.
 - In Free Channel Call zones, the transceiver will automatically search for any signal and will receive on that channel.
- 2 When you hear a caller's voice, readjust the volume as necessary.

SCAN

If the Scan function is programmed, Conventional zones or channels can be scanned by pressing the key programmed as **Scan**. Scan can be used as either Single Scan or Multi Scan.

- Single Scan monitors only the channels of the currently selected zone, which have been added to the Scan list. If set up to scan the Priority channel, the Priority channel will be scanned even if it is not within the currently selected zone.
- Multi Scan monitors all channels of every zone, which have been added to the Scan list.

To activate Scan, press the key programmed as **Scan**.

- The  icon and “SCAN” (TK-7160/ TK-8160) or “-” (TK-7162/ TK-8162) appears on the display.
- When a call is received, scanning stops and the zone and channel digits appear. Press the microphone **PTT** switch and speak into the microphone to respond to the call. The transceiver will continue scanning after a predetermined time delay if the **PTT** switch is released and no further signal is received.

To stop scanning, press the **Scan** key again.

Note: In order for Scan to function, there must be at least 2 channels added to the scanning sequence. If there are less channels than this, Scan will not operate.

PRIORITY SCAN

Your dealer may have set up a Priority channel on your transceiver.

During Priority Scan, the transceiver will continuously monitor the Priority channel while receiving a signal on another channel. When a signal is received on the Priority channel, the transceiver immediately switches to that channel. The  icon appears on the display, indicating that the Priority channel is the current channel.





The transceiver remains on the Priority channel until the signal is no longer present. When the signal “drops out”, the transceiver will remain on the channel momentarily before scan resumes. This delay time is programmed by your dealer.

ADD TO SCAN/ DELETE FROM SCAN

Depending on how your transceiver has been set up, a key may have been programmed with the **Scan Del/Add** function. This function allows you to scan only those channels which you desire.



To add or remove a channel to/from the Scan list, select the desired channel then press the **Scan Del/Add** key.

To temporarily remove a channel from the Scan list, during Scan, press the **Scan Del/Add** key while Scan is paused on the undesired channel. After switching the Scan function OFF, or switching the transceiver OFF and then ON again, the Scan settings return to normal.

- The  (TK-7160/ TK-8160) or  (TK-7162/ TK-8162) icon appears on the display when the selected channel is added to the Scan list. The  (TK-7160/ TK-8160) or  (TK-7162/ TK-8162) icon disappears when the selected channel is removed from the Scan list.

On TK-7160/ TK-8160 transceivers, you can also add or remove a zone to/from the Scan list. To add or remove a zone to/from the Scan list, select the desired zone then press and hold the **Scan Del/Add** key for approximately 1 second.

To temporarily remove a zone from the Scan list, during Scan, press and hold the **Scan Del/Add** key for approximately 1 second while Scan is paused on a channel in the undesired zone. After switching the Scan function OFF, or switching the transceiver OFF and then ON again, the Scan settings return to normal.

- The  icon appears on the display when the selected zone is added to the Scan list. The  icon disappears when the selected zone is removed from the Scan list.

REVERT CHANNEL

During Scan, pressing the **PTT** switch to transmit will cause the transceiver to select the Revert channel. Your dealer programs the Revert channel for your transceiver with one of the following six types:

- **Selected:** The last channel selected prior to Scan is the Revert channel.
- **Selected + Talkback:** While the transceiver is paused on a channel during Scan, pressing the **PTT** switch will allow you to transmit (talk back) on the current channel. Otherwise, the last channel selected prior to Scan is the Revert channel.
- **Priority:** If your dealer has programmed a Priority channel, this channel is the Revert channel.
- **Priority + Talkback:** While the transceiver is paused on a channel during Scan, pressing the **PTT** switch will allow you to transmit (talk back) on the current channel. Otherwise, the Priority channel is the Revert channel.
- **Last Called:** The last channel on which a call was received is the Revert channel, even if Scan has already resumed.
- **Last Used:** The last channel on which you transmitted is the Revert channel.

DTMF CALLS

Note: To make DTMF calls, you must use an optional microphone with a DTMF keypad.

STORE & SEND (TK-7160/ TK-8160 ONLY)

- 1 Enter the desired digits on the microphone keypad.
 - You can enter a maximum of 16 digits (**0 ~ 9, A ~ D, * , and #**).
 - The digits appear on the display as you enter them.
 - If Keypad Auto-PTT is enabled by your dealer, this method of entering a string of digits will not function. Refer to “MANUAL DIALING”, below.
- 2 Press the **PTT** switch to transmit the entered digits.

MANUAL DIALING

- 1 Press and hold the **PTT** switch.
- 2 Enter the desired digits on the microphone keypad.
 - You can enter the digits **0 ~ 9, A ~ D, * , and #**. (**A ~ D** may be disabled by your dealer.)
 - If Keypad Auto-PTT is enabled by your dealer, you do not need to press the **PTT** switch while entering digits; the transceiver will transmit the DTMF tones automatically as you enter the digits.

STORING DTMF NUMBERS

If Auto Dialing has been activated by your dealer, you can store DTMF numbers (16 digits maximum) in each of the 9 Auto Dial memory locations (1 ~ 9).

- 1 Press the microphone **#** key.
 - “**7**” (TK-7160/ TK-8160) or “**4**” (TK-7162/ TK-8162) appears on the display.
- 2 Enter the desired digits on the microphone keypad.
 - You can enter the digits **0 ~ 9, A ~ D, * , and #**.
 - To enter “**#**”, press and hold the **PTT** switch while entering the **#** key.
 - To cancel, press any key on the transceiver front panel.
- 3 Press the microphone **#** key, then enter a memory location number (1 ~ 9).

DIALING STORED DTMF NUMBERS

- 1 Press the microphone * key.
 - “R” (TK-7160/ TK-8160) or “R₈” (TK-7162/ TK-8162) appears on the display.
- 2 Enter the desired memory location number (1 ~ 9).
 - The digits stored in the selected location number appear on the display.
 - To cancel, press any key other than the **PTT** switch.
- 3 Press the **PTT** switch.
 - If programmed by your dealer, no DTMF tone will sound when “D” is transmitted. “D” can be used for a pause duration. The pause duration is programmed by your dealer.

CLEARING STORED DTMF NUMBERS

- 1 Press the microphone # key.
 - “J” (TK-7160/ TK-8160) or “J₈” (TK-7162/ TK-8162) appears on the display.
- 2 Press the microphone # key again.
 - “J-LR” (TK-7160/ TK-8160) or “J₈” (TK-7162/ TK-8162) appears on the display.
 - To cancel, press any key other than 1 ~ 9.
- 3 Enter the memory location number (1 ~ 9) you want to clear.
 - The memory location number is cleared and the display returns to normal.

REDIALING

- 1 Press the microphone * key.
 - “R” (TK-7160/ TK-8160) or “R₈” (TK-7162/ TK-8162) appears on the display.
- 2 Press the microphone 0 key.
 - On TK-7160/ TK8160 transceivers, the digits last dialed appear on the display. (Nothing is displayed on TK-7162/ TK-8162 transceivers.)
 - If there is no data in the redial memory, an error tone will sound.
 - To cancel, press any key other than the **PTT** switch.
- 3 Press the **PTT** switch.

Note: Switching the transceiver power OFF clears the redial memory.

STUN

This function is used when a transceiver is stolen or lost. When the transceiver receives a call containing a stun code, either transmit mode will be disabled, or both receive mode and transmit mode will be disabled. The stun code is cancelled when the transceiver receives a call with a revive code.

QUIET TALK (QT)/ DIGITAL QUIET TALK (DQT)

Your dealer may have programmed QT or DQT signaling on your transceiver channels. A QT tone/ DQT code is a sub-audible tone/code which allows you to ignore (not hear) calls from other parties who are using the same channel.

When a channel is set up with a QT tone or DQT code, squelch will only open when a call containing a matching tone or code is received. Likewise, signals that you transmit will only be heard by parties whose QT/ DQT signaling matches your transceiver.

If a call containing a different tone or code is made on the same channel you are using, squelch will not open and you will not hear the call. This allows you to ignore (not hear) these calls. Although it may seem like you have your own private channel while using QT/ DQT, other parties can still hear your calls if they set up their transceiver with the same tone or code.

OPERATOR SELECTABLE TONE (OST) (TK-7160/ TK-8160 ONLY)

You can change the preset encode and decode tones for the selected channel. Up to 40 tones can be pre-programmed by your dealer.

- 1 Select your desired channel.
- 2 Press the key programmed as **Operator Selectable Tone**.
 - "TONE OFF" or the OST name or number appears on the display.
- 3 Press the **<B** and **C>** keys to select the desired OST name/ number.
- 4 Use the transceiver the same as in a regular call; press the **PTT** switch to transmit and release it to receive.
- 5 To exit OST mode and return to the preset encode and decode tones, press the **S** key.

CODE SQUELCH (ID CODE)

Code Squelch is enabled or disabled by your dealer. This function turns the transceiver squelch OFF only when it receives the DTMF ID code that has been set up in your transceiver. Transceivers that do not transmit the correct code will not be heard. Consequently, you can communicate with a specific party without listening to other parties using the same channel.

Your dealer may also activate Group Call for your transceiver. This is useful when you want to send information to a number of units in a fleet. Ask your dealer for details.

Note: Code Squelch cannot be used on this transceiver if Selective Call {page 18} or DTMF Number Display {page 28} have been programmed.

RECEIVING

When you receive a signal containing the correct ID code, the squelch opens and you will hear the call.

- The 🎵 icon (TK-7160/ TK-8160) appears on the display and blinks.
- The TX/RX indicator flashes orange.
- To mute the speaker after the squelch opens, press the key programmed as **Monitor**.
- Your dealer can program the transceiver to mute the speaker after a specified time period elapses.
- If Transpond is programmed, an acknowledgment signal is returned to the calling station. Transpond does not function when you are called with a Group code. Transpond can send an alert tone, a transceiver ID code, or autodial memory location number 1 (refer to “STORING DTMF NUMBERS” on page 14).
- If Call Alert is programmed, an alert tone will sound when the correct ID code is received.

TRANSMITTING

- 1 Press and hold the microphone **PTT** switch.
- 2 Enter the ID code of the transceiver you want to call or enter a Group code on the microphone keypad.
- 3 Use the transceiver the same as in a regular call; press the microphone **PTT** switch to transmit and release it to receive. Your dealer can program your transceiver with the following additional features:
 - The 🎵 icon (TK-7160/ TK-8160) appears on the display.
 - When you release the microphone **PTT** switch, the squelch opens. If no signal is received for a pre-determined time, the speaker will mute.
 - Pressing the key programmed as **Monitor** at any time will mute the speaker.

SELECTIVE CALL (TK-7160/ TK-8160 ONLY)

Selective Call is enabled or disabled by your dealer. This function is similar to Code Squelch {page 17}. The differences from Code Squelch are:

- You can send or receive Status codes containing up to 5 digits.
- Selective Call opens the squelch only when the transceiver receives a predetermined DTMF code in the correct sequence (3-digit or 4-digit ID code — 1-digit Intermediate code — Status code of up to 5 digits).

Your dealer may also activate Group Call for your transceiver. This is useful when you want to send information to a number of units in a fleet. Ask your dealer for details.

Note: Selective Call cannot be used on this transceiver if Code Squelch {page 17} or DTMF Number Display {page 28} have been programmed.

RECEIVING

When you receive the correct ID and Intermediate codes, the squelch opens and you will hear the call. If a Status code is also received, the code will appear on the display. For example, if the Status code “12345” was received, “*㊤* 12345” appears on the display. (“*㊤*” appears in place of “*㊤*” for group calls.)

- The  icon appears on the display and blinks.
- When no Status code is received “*NO DATA*” appears on the display.
- You can clear the Status code by pressing any key or returning the microphone to its hook.
- To mute the speaker after squelch opens, press the key programmed as **Monitor**.
- Your dealer can program the transceiver to mute the speaker after a specified time period elapses.
- If Transpond is programmed, an acknowledgment signal is returned to the calling station. Transpond does not function when you are called with a Group code. Transpond can send an alert tone, a transceiver ID code, or autodial memory location number 1 (refer to “STORING DTMF NUMBERS” on page 14).
- If Call Alert is programmed, an alert tone will sound when the correct code is received.

TRANSMITTING

- 1 Press and hold the microphone **PTT** switch.
- 2 Enter the ID code (or Group code) and Intermediate code of the transceiver you want to call on the microphone keypad.
 - If desired, you can also enter a Status code of up to 5 digits.
 - You can send codes the same way you make DTMF calls {page 14}.
- 3 Use the transceiver the same as in a regular call; press the microphone **PTT** switch to transmit and release it to receive. Your dealer can program your transceiver with the following additional features:
 - The  icon appears on the display.
 - When you release the microphone **PTT** switch, the squelch opens. If no signal is received for a pre-determined time, the speaker will mute.
 - Pressing the key programmed as **Monitor** at any time will mute the speaker.

FleetSync: ALPHANUMERIC 2-WAY PAGING FUNCTION

FleetSync is an Alphanumeric 2-way Paging Function and is a protocol owned by **KENWOOD** Corporation. FleetSync enables a variety of paging functions on your transceiver, some of which depend on dealer programming.

The TK-7162/ TK-8162 only has access to the PTT ID function of the FleetSync feature.

Note: Your transceiver functions include either FleetSync or 5-tone Signaling (page 22), but not both.

SELCALL (SELECTIVE CALLING)

A Selcall is a voice call to a particular station or to a group of stations.

■ Transmitting (TK-7160/ TK-8160 Only)

- 1 Select your desired zone and channel.
- 2 Press the key programmed as **Selcall** or **Selcall + Status** to enter Selcall mode.
- 3 Press the **<B** and **C>** keys to select the ID of the station you want to call, or enter a station ID using a DTMF keypad.
 - If Manual Input mode is enabled, you can enter digits by using a DTMF keypad. To enter Manual Input mode, first press and hold the **S** or DTMF ***** key.
- 4 Press the microphone **PTT** switch and begin your conversation.

■ Receiving

The calling station's ID will appear (TK-7160/ TK-8160) and an alert tone will sound when a Selcall is received.

To respond to the call, press the **PTT** switch and speak into the microphone.

■ Identification Codes

An ID code is a combination of a 3-digit Fleet number and a 4-digit ID number. Each transceiver must have its own Fleet and ID number.

- Enter a Fleet number (100 ~ 349) to make a group call.
- Enter an ID number (1000 ~ 4999) to make an individual call in your fleet.
- Enter a Fleet number to make a call to all units in the selected fleet (Interfleet call).
- Enter an ID number to make a call to the selected ID in all fleets (Supervisor call).
- Select "ALL" Fleet and "ALL" ID to make a call to all units (Broadcast call).

Note: The ID range may be limited by programming.

STATUS MESSAGE (TK-7160/ TK-8160 ONLY)

You can send and receive 2-digit Status messages which may be decided in your talk group. Messages can contain up to 16 alphanumeric characters. Status messages range from 10 to 99 (80 ~ 99 are reserved for special messages).

A maximum of 5 received messages can be stored in the stack memory of your transceiver. These saved messages can be reviewed after reception.

Depending on your dealer settings, when the stack memory is full, either the oldest message will be erased when a new message is received or the new message will not be stored in the stack memory. The  icon lights when a message is stored in the stack memory.

■ Transmitting

- 1 Select your desired zone and channel.
- 2 Press the key programmed as **Status** to enter Status mode or **Selcall + Status** to enter Selcall mode.
 - When using the **Status** key to enter Status mode, the station ID is fixed and cannot be selected. Skip to step 5 to continue.
- 3 In Selcall Mode, press the **<B** and **C>** keys to select the ID of the station you want to call, or enter a station ID using a DTMF keypad.
 - If Manual Input mode is enabled, you can enter digits by using a DTMF keypad. To enter Manual Input mode, first press and hold the **S** or DTMF ***** key.
- 4 Press the **S** or DTMF ***** key to enter Status mode.
- 5 Press the **<B** and **C>** keys to select the status ID you want to transmit, or enter a station ID using a DTMF keypad.
 - If Manual Input mode is enabled, you can enter digits by using a DTMF keypad. To enter Manual Input mode, first press and hold the **S** or DTMF ***** key.
- 6 Press the microphone **PTT** switch to initiate the Status call.

■ Receiving

The  icon will flash, an alert tone will sound, and a calling ID or text message will appear when a Status call is received.

Press any key to return to normal operation.

■ Reviewing Messages in the Stack Memory

- 1 Press and hold the key programmed as **Selcall**, **Status**, or **Selcall + Status** for 1 second to access the stack memory.
 - The last received message is displayed with the message number.
- 2 Press the **<B and C>** keys to select your desired message.
 - Press and hold the **S** or *** key** to toggle between the message/ call ID and the channel name of the received message.
- 3 Press the **S** key to return to normal operation.
 - To delete the selected message, press the **A** or **#** key. To confirm the deletion, press the **S** or *** key**.
 - To delete all messages, press and hold the **A** or **#** key for 1 second. To confirm the deletion, press the **S** or *** key**.

GPS REPORT (TK-7160/ TK-8160 ONLY)

If a GPS unit (NMEA-0183 format) is installed on your transceiver and the Send GPS function has been programmed onto a key by your dealer, press the **Send the GPS data** key to send your location data.

5-TONE SIGNALING

5-tone Signaling is enabled or disabled by your dealer. This function opens the squelch only when the transceiver receives the 5 tones programmed in your transceiver. Transceivers that do not transmit the correct tones will not be heard.

Note: Your transceiver functions include either 5-tone Signaling or FleetSync (page 19), but not both.

My ID

Your dealer can program an ID number for your transceiver, to identify you to other parties when you make a call. On TK-7160/ TK-8160 transceivers, if set by your dealer, you can edit the ID number:

- 1 If the ID number is set to be edited, the ID number will appear on the display when you turn the transceiver power ON.
- 2 To change the ID number, enter the new ID by pressing the \wedge and \vee keys or using the DTMF keypad.
 - When pressing the \wedge and \vee keys to enter a digit, select the desired digit, then press the **<B** or **<C>** key to shift the cursor to the left or right. Repeat this process until the entire ID is entered.
- 3 Press the **S** or ***** key to complete the entry.

MAKING A SELCALL (SELECTIVE CALLING) (TK-7160/ TK-8160 ONLY)

A Selcall is a voice call to a particular station. To make a Selcall:

- 1 Select your desired zone and channel.
- 2 Press the key programmed as **Selcall (5-tone)** to enter Selcall Mode.
- 3 Press the \wedge and \vee keys or enter an appropriate number using the DTMF keypad to select the ID of the station you want to call.
 - When pressing the \wedge and \vee keys to enter a digit, select the desired digit, then press the **<B** or **<C>** key to shift the cursor to the left or right. Repeat this process until the entire ID is entered.
 - Press and hold the **0** key to enter a Group digit.
 - Alternatively, press and hold the **S** or ***** key to enter Selcall List mode. With the Selcall List activated, you can select the desired station by pressing the \wedge and \vee keys. Press and hold the \blacktriangle key to toggle the display between the station name and the list number.
- 4 Press the **S** or ***** key to complete the entry.
- 5 Press the key programmed as **Call 1** or **Call 2** to begin your call.

Note: Additionally, you can also use the keys programmed as **Digit 1x Down**, **Digit 1x Up**, **Digit 10x Down**, and **Digit 10x Up** keys to adjust the Selcall number. **Digit 1x Up/Down** increases/decreases the Selcall number by 1 each time the key is pressed. **Digit 10x Up/Down** increases/decreases the Selcall number by 10 each time the key is pressed.

RECEIVING A SELCALL

When you receive a signal containing the correct tones, squelch opens and you will hear the call.

- The LED indicator flashes orange.
- To mute the speaker after squelch opens, press the key programmed as **Monitor**.
- Your dealer can program the Monitor function to close again after a specific time period elapses.
- If Transpond for 5-tone Signaling is programmed, an acknowledgement signal is returned to the calling station.
- If Call Alert for 5-tone Signaling is programmed, an alert tone will sound when the correct tones are received.
- Your dealer can program the transceiver to display the received Selcall/Status.

To respond to the call, press the microphone **PTT** switch and speak into the microphone.

EMERGENCY OPERATION

If your transceiver has been programmed with the Emergency function, you can make emergency calls.

1 Press and hold the key programmed as **Emergency**.

- Depending on the delay time programmed into your transceiver, the length of time you must hold the **Emergency** key will vary.
- When the transceiver enters Emergency mode, the transceiver will change to the Emergency channel and begin transmitting based on how the transceiver is set up by your dealer. Transmit periods are also set by your dealer.

2 To exit Emergency mode, press and hold the **Emergency** key again.

- If the Emergency mode completes the preset number of cycles, Emergency mode will automatically end and the transceiver will return to the channel that was in use before Emergency mode was entered.

Note: Your dealer can set the transceiver to emit tones and received signals as normal or mute the speaker during Emergency operation.

LONE WORKER MODE

Lone Worker Mode is a safety feature built into the transceiver. If the transceiver is not operated for a period of time that exceeds the programmed time, the transceiver will emit a tone and automatically enter Emergency operation.

The default Lone Worker duration is 10 minutes. Your dealer can set the duration to last from 1 minute to 60 minutes.

The Lone Worker function can be toggled ON or OFF by pressing and holding the key programmed as **Lone Worker** for 2 seconds.

ADVANCED OPERATIONS

TALK AROUND

You may occasionally experience an interruption in service (due to a power failure, etc.). During such an occurrence, you can continue communication by using the Talk Around feature if it has been programmed by your dealer. Talk Around allows you to communicate directly with other transceivers without the use of a repeater. However, if the station you want to contact is too far away, or there are geographical obstacles in the way, you may not be able to contact the station.

Press the key programmed as **Talk Around** to activate the Talk Around function.

- The  icon appears on the display while the Talk Around function is ON.
- When using Talk Around, the receive frequency is used for both transmission and reception, and the decode signaling is used for both encoding and decoding.

Press the **Talk Around** key again to deactivate the Talk Around function.

KEY LOCK

Press the key programmed as **Key Lock** to lock the keys of the transceiver. Locking the transceiver keys prevents you from accidentally changing the channel and channel settings.



While Key Lock is active, you can still use the microphone **PTT** switch, the  (power) switch, and the **Emergency, Monitor, and Squelch Off** keys. If set up by your dealer, you can also use the **Volume Up** and **Volume Down** keys.

- “LOCKED” (TK-7160/ TK-8160) or “L” (TK-7162/ TK-8162) momentarily appears on the display when the Key Lock function is activated or when a key is pressed while the Key Lock function is ON.

Press the **Key Lock** key again to turn this function OFF.



AUXILIARY PORT

Press the key programmed as **AUX** to activate the auxiliary port. The auxiliary port is used with optional boards.

- The  (TK-7160/ TK-8160) or  (TK-7162/ TK-8162) icon appears on the display when the auxiliary port is activated.

HORN ALERT

Press the key programmed as **Horn Alert** to activate the Horn Alert function. The Horn Alert function can only be used with an optional board.

- The  (TK-7160/ TK-8160) or  (TK-7162/ TK-8162) icon appears on the display when the Horn Alert function is activated.

DISPLAY BRIGHTNESS (TK-7160/ TK-8160 ONLY)

You can toggle the display brightness between high and low by pressing the key programmed as **LCD Brightness**.

- The default brightness level is set to high.

DIRECT CHANNEL

On TK-7160/ TK-8160 transceivers, press the key programmed as **Direct Zone-Channel** to immediately select the lowest channel of the lowest zone.

On TK-7162/ TK-8162 transceivers, press the key programmed as **Direct CH** to immediately select the lowest channel.

MONITOR/ SQUELCH OFF

You can use the key programmed as **Monitor/ Squelch Off** to listen to weak signals that you cannot hear during normal operation and to adjust the volume when no signals are present on your selected channel.

- The  icon appears on the display while Monitor/ Squelch Off is activated.

Your dealer can program a key with one of 4 functions:

- **Monitor:** Momentarily press to deactivate QT, DQT, DTMF, 5-tone, or FleetSync Signaling. Press the key again to return to normal operation.
- **Monitor Momentary:** Press and hold to deactivate QT, DQT, DTMF, 5-tone, or FleetSync Signaling. Release the key to return to normal operation.
- **Squelch Off:** Momentarily press to hear background noise. Press the key again to return to normal operation.
- **Squelch Off Momentary:** Press and hold to hear background noise. Release the key to return to normal operation.

■ Squelch Level

If a key has been programmed as **Squelch Level**, you can readjust your transceiver's squelch level:

- 1 Press the key programmed as **Squelch Level**.
 - The  icon and the current squelch level appears on the display.
- 2 Press the **<B** and **C>** keys to select the desired squelch level.
- 3 Press the **S** or **▲** key to store the new setting and exit Squelch Level Adjustment mode.

VOICE SCRAMBLER

Note: There are 2 options for using the scrambler. Your dealer can activate or deactivate the built-in scrambler function of the transceiver, or they can add a more secure optional scrambler board to your transceiver. Ask your dealer for details.

Although the built-in scrambler function does not offer complete privacy with your calls, it does prevent others from easily listening in on your calls. When activated, the transceiver distorts your voice so that anybody listening to your conversation will not be able to clearly hear what you are saying.

In order for members of your own group to clearly hear your call while you are using the scrambler, all other members must also activate the scrambler functions on their transceivers. This distorts everybody's voice while transmitting and corrects the voice message on your own transceiver when you receive the call.

Press the key programmed as **Scrambler** to activate the Scrambler.

- The  icon appears on the display while the scrambler is active.

Press the **Scrambler** key again to deactivate the Scrambler.

On the TK-7160/ TK-8160 transceiver, when using an optional scrambler board, you can change the scrambler code set up on your transceiver using the **Scrambler** key:

- 1 Press and hold the key programmed as **Scrambler** for 2 seconds.
 - The current scrambler code appears on the display.
- 2 Press the **<B and C>** keys to select the desired scrambler code.
- 3 Press the **S** or **▲** key to store the new setting and exit Scrambler Code Select mode.
 - After changing your scrambler code, be sure to inform all members of your group of the new code so they can reset their transceivers as well. The scrambler function will not perform correctly between transceivers that are set up with different scrambler codes.

BACKGROUND OPERATIONS

TIME-OUT TIMER (TOT)

The purpose of the Time-out Timer is to prevent any caller from using a channel for an extended period of time. If you continuously transmit for a period of time that exceeds the programmed time, the transceiver will stop transmitting and an alert tone will sound. To stop the tone, release the **PTT** switch.

The default TOT duration is 1 minute. Your dealer can set the duration to last from 15 seconds to 10 minutes.

Your dealer can also program a warning function to alert you before the TOT expires. Continuously transmitting for the time specified by your dealer will cause this warning tone to sound, allowing you to finish your transmission before the TOT expires.

BUSY CHANNEL LOCKOUT (BCL)

The Busy Channel Lockout feature is activated or deactivated by your dealer.

When activated, BCL prevents you from interfering with other parties who may be using the same channel that you selected. Pressing the **PTT** switch while the channel is in use will cause your transceiver to emit an alert tone and transmission will be inhibited (you cannot transmit). Release the **PTT** switch to stop the tone and return to receive mode.

BEGINNING/ END OF TRANSMIT SIGNAL

Your dealer can enable or disable the Beginning/ End of Transmit identification signals. These signals are used to access and release some repeaters and telephone systems.

A Beginning of Transmit (BoT) Signal is sent when you press the **PTT** switch.

An End of Transmit Signal (EoT) is sent when you release the **PTT** switch.

DTMF NUMBER DISPLAY (TK-7160/ TK-8160 ONLY)

Note: This feature can only be activated when DTMF Signaling is turned OFF.

When you receive a DTMF code containing at least 3 digits, it will appear on the display. If no digit is received for more than 1 second, the display will clear and begin with the new digit when the next digit is received.

- The transceiver can display a maximum of 8 digits at a time.

Cancel the DTMF Number Display by pressing any key other than the **Volume Up** and **Volume Down** keys.

You can transmit DTMF codes by entering them into an optional microphone with a DTMF keypad.

KENWOOD

CE 0168!