



**NONRESIDENT
TRAINING
COURSE**

**Navy Electricity and
Electronics Training Series**

**Module 19—The Technician's
Handbook**

NAVEDTRA 14191

Notice: NETPDTC is no longer responsible for the content accuracy of the NRTCs.

For content issues, contact the servicing Center of Excellence: Center for Surface Combat System (CSCS); (540) 284-1061 or DSN: 249-1061.

PREFACE

About this course:

This is a self-study course. By studying this course, you can improve your professional/military knowledge, as well as prepare for the Navywide advancement-in-rate examination. It contains subject matter about day-to-day occupational knowledge and skill requirements and includes text, tables, and illustrations to help you understand the information. An additional important feature of this course is its reference to useful information in other publications. The well-prepared Sailor will take the time to look up the additional information.

Training series information:

This is Module 19 of a series.

History of the course:

Sep 1998: Original edition released. Prepared by TMCM Jack L. Formyduval.

*Jan 2004: Administrative update released. Reviewed and revised by ETC(SW) Jack Weatherford.
Minor revision to technical content.*

TABLE OF CONTENTS

CHAPTER	PAGE
1. The Technician's Handbook	1-1
APPENDIX	
I. References Used to Develop This NRTC	AI-1

NAVY ELECTRICITY AND ELECTRONICS TRAINING SERIES

The Navy Electricity and Electronics Training Series (NEETS) was developed for use by personnel in many electrical- and electronic-related Navy ratings. Written by, and with the advice of, senior technicians in these ratings, this series provides beginners with fundamental electrical and electronic concepts through self-study. The presentation of this series is not oriented to any specific rating structure, but is divided into modules containing related information organized into traditional paths of instruction.

The series is designed to give small amounts of information that can be easily digested before advancing further into the more complex material. For a student just becoming acquainted with electricity or electronics, it is highly recommended that the modules be studied in their suggested sequence. While there is a listing of NEETS by module title, the following brief descriptions give a quick overview of how the individual modules flow together.

Module 1, *Introduction to Matter, Energy, and Direct Current*, introduces the course with a short history of electricity and electronics and proceeds into the characteristics of matter, energy, and direct current (dc). It also describes some of the general safety precautions and first-aid procedures that should be common knowledge for a person working in the field of electricity. Related safety hints are located throughout the rest of the series, as well.

Module 2, *Introduction to Alternating Current and Transformers*, is an introduction to alternating current (ac) and transformers, including basic ac theory and fundamentals of electromagnetism, inductance, capacitance, impedance, and transformers.

Module 3, *Introduction to Circuit Protection, Control, and Measurement*, encompasses circuit breakers, fuses, and current limiters used in circuit protection, as well as the theory and use of meters as electrical measuring devices.

Module 4, *Introduction to Electrical Conductors, Wiring Techniques, and Schematic Reading*, presents conductor usage, insulation used as wire covering, splicing, termination of wiring, soldering, and reading electrical wiring diagrams.

Module 5, *Introduction to Generators and Motors*, is an introduction to generators and motors, and covers the uses of ac and dc generators and motors in the conversion of electrical and mechanical energies.

Module 6, *Introduction to Electronic Emission, Tubes, and Power Supplies*, ties the first five modules together in an introduction to vacuum tubes and vacuum-tube power supplies.

Module 7, *Introduction to Solid-State Devices and Power Supplies*, is similar to module 6, but it is in reference to solid-state devices.

Module 8, *Introduction to Amplifiers*, covers amplifiers.

Module 9, *Introduction to Wave-Generation and Wave-Shaping Circuits*, discusses wave generation and wave-shaping circuits.

Module 10, *Introduction to Wave Propagation, Transmission Lines, and Antennas*, presents the characteristics of wave propagation, transmission lines, and antennas.

Module 11, *Microwave Principles*, explains microwave oscillators, amplifiers, and waveguides.

Module 12, *Modulation Principles*, discusses the principles of modulation.

Module 13, *Introduction to Number Systems and Logic Circuits*, presents the fundamental concepts of number systems, Boolean algebra, and logic circuits, all of which pertain to digital computers.

Module 14, *Introduction to Microelectronics*, covers microelectronics technology and miniature and microminiature circuit repair.

Module 15, *Principles of Synchros, Servos, and Gyros*, provides the basic principles, operations, functions, and applications of synchro, servo, and gyro mechanisms.

Module 16, *Introduction to Test Equipment*, is an introduction to some of the more commonly used test equipments and their applications.

Module 17, *Radio-Frequency Communications Principles*, presents the fundamentals of a radio-frequency communications system.

Module 18, *Radar Principles*, covers the fundamentals of a radar system.

Module 19, *The Technician's Handbook*, is a handy reference of commonly used general information, such as electrical and electronic formulas, color coding, and naval supply system data.

Module 20, *Master Glossary*, is the glossary of terms for the series.

Module 21, *Test Methods and Practices*, describes basic test methods and practices.

Module 22, *Introduction to Digital Computers*, is an introduction to digital computers.

Module 23, *Magnetic Recording*, is an introduction to the use and maintenance of magnetic recorders and the concepts of recording on magnetic tape and disks.

Module 24, *Introduction to Fiber Optics*, is an introduction to fiber optics.

Embedded questions are inserted throughout each module, except for modules 19 and 20, which are reference books. If you have any difficulty in answering any of the questions, restudy the applicable section.

Although an attempt has been made to use simple language, various technical words and phrases have necessarily been included. Specific terms are defined in Module 20, *Master Glossary*.

Considerable emphasis has been placed on illustrations to provide a maximum amount of information. In some instances, a knowledge of basic algebra may be required.

Assignments are provided for each module, with the exceptions of Module 19, *The Technician's Handbook*; and Module 20, *Master Glossary*. Course descriptions and ordering information are in NAVEDTRA 12061, *Catalog of Nonresident Training Courses*.

Throughout the text of this course and while using technical manuals associated with the equipment you will be working on, you will find the below notations at the end of some paragraphs. The notations are used to emphasize that safety hazards exist and care must be taken or observed.

WARNING

AN OPERATING PROCEDURE, PRACTICE, OR CONDITION, ETC., WHICH MAY RESULT IN INJURY OR DEATH IF NOT CAREFULLY OBSERVED OR FOLLOWED.

CAUTION

AN OPERATING PROCEDURE, PRACTICE, OR CONDITION, ETC., WHICH MAY RESULT IN DAMAGE TO EQUIPMENT IF NOT CAREFULLY OBSERVED OR FOLLOWED.

NOTE

An operating procedure, practice, or condition, etc., which is essential to emphasize.

CHAPTER 1

THE TECHNICIAN'S HANDBOOK

Here, in one compact module, you will be able to find essential information and reference material. Whether you want to know safety precautions, first aid, or any number of helpful pieces of information, you will find it indexed.

We have included electrical and electronic formulas, data tables, and general maintenance hints. In most cases you will find references to other more detailed sources included.

We solicit your suggestions, maintenance hints, and constructive criticism. You will receive credit in future editions of this handbook if your input is used.

MISHAP PREVENTION AND AFTERCARE

Most of us working with electricity take risks. Usually we get our jobs done without any harmful results. Mishaps or injuries usually result from not understanding a risk or danger.

The first part of this handbook is designed to help you eliminate or minimize mishaps. It also provides you with a good review of what to do in case of a mishap.

SAFETY OBSERVATIONS FOR THE ELECTRICAL AND ELECTRONICS TECHNICIAN

Working safely is the most important thing you can do. Because of their importance, several precautions are included as the first subject in this handbook. Of course there are more precautions, but these are some you should think about. The keyword here is *think*. Think safety.

- Never work alone.
- Never receive an intentional shock.
- Only work on, operate, or adjust equipment if you are authorized.
- Don't work on energized equipment unless absolutely necessary.
- Keep loose tools, metal parts, and liquids from above electrical equipment. Never use steel wool or emery cloth on electric and electronic circuits.
- Never attempt to repair energized circuits except in an emergency.
- Never measure voltage in excess of 300 volts while holding the meter wire or probe.
- Use only one hand when operating circuit breakers or switches.
- Use proper tag-out procedures for regular and preventive maintenance.

- Be cautious when working in voids or unvented spaces.
- Beware the dangers of working aloft. Never attempt to stop a rotating antenna manually.
- Keep protective closures, fuse panels, and circuit breaker boxes closed unless you are actually working on them.
- Never bypass an interlock unless you are authorized to do so by the commanding officer, and then properly tag the bypass.
- Use extreme caution when handling cathode-ray tubes. They implode violently if broken. The anode contact may have a residual electrical charge. Make sure you discharge the anode before handling.

You can find additional and more detailed information on safety in the Electronics Installation and Maintenance Book (EIMB), *General*, NAVSEA SE000-00-EIM-100, paragraph 3-4. Another excellent reference source is the Naval Electronics Systems Command's *Electronic Safety Handbook*, E0410-AA-HBK-010/00K ELEXSAFE.

FIRST AID

First aid is the emergency care you give to sick or injured persons. It consists only of providing temporary assistance or treatment until medical help is available. In addition to knowing what to do for a victim, you should also know what not to do.

This section should be used to reinforce the knowledge you already have about first aid. First aid is included in detail for the purposes of review, study, and ready reference.

First aid study classes are usually available through your medical department or the American Red Cross.

Your knowledge of first aid measures and their proper application may mean the difference between life and death, between rapid recovery and long hospitalization, or between temporary disability and permanent injury.

The objectives of first aid are to save life and prevent further injury. First aid is not a substitute, however, for proper medical treatment. Keep in mind the objectives of first aid. Everyone in the Navy must know when and how to apply first aid measures and must be prepared to give assistance to persons injured in battle, collision, fire, or accidents.

In administering first aid, you have three primary tasks:

- Maintain breathing
- Stop bleeding
- Prevent or reduce shock

The first step, of course, is to determine the extent of the victim's injuries. When you treat a victim, first consideration usually must be given to the most serious injury. In general, the order of treatment is to restore breathing, stop bleeding, and treat for shock.

Work quickly, but do not rush around frantically. Do not waste time looking for ready-made materials; do the best you can with whatever is at hand. Send for medical help as soon as possible.

Although each case involving injury or sickness presents its own special problems, the following general rules apply to practically all situations. Become familiar with these basic rules before you go on to first aid treatment for specific types of injuries.

1. Keep the victim lying down, head level with the body, until you have found out what kind of injury has occurred and how serious it is. If the victim shows one of the following difficulties, however, follow the rule given for that specific problem:
 - a. Vomiting or bleeding about the mouth and semi-consciousness. If the victim is in danger of sucking in blood, vomited matter, or water, place the victim on his/her side or back with the head turned to one side and lower than the feet.
 - b. Shortness of breath. If the victim has a chest injury or breathing difficulties, place the victim in a sitting or semi-sitting position.
 - c. Shock. If the victim is in shock, place the person on his or her back with the head slightly lower than the feet.
2. Move the victim no more than is absolutely necessary. To determine the extent of the victim's injuries, carefully rip or cut the clothing along the seams. If done improperly, the removal of the victim's clothing could cause great harm, especially if fracture injuries are involved. When the clothing is removed, ensure that the victim does not become chilled. Shoes may also be cut off to avoid causing pain or increasing an injury.
3. The victim need not see the actual injury(ies). You can supply reassurance and make the victim more comfortable by ensuring him or her that the injuries incurred are understood and medical attention will be given as soon as possible.
4. Do not touch open wounds or burns with fingers or other objects, except when sterile compresses or bandages are not available and it is absolutely necessary to stop severe bleeding.
5. Do not try to give an unconscious person any solid or liquid substance by mouth. The person may vomit and get some of the material into the lungs when he or she breathes, causing choking and possibly death.
6. If a bone is broken, or you suspect that one is broken, do not move the victim until you have immobilized the injured part. This may prove life saving in cases of severe bone fractures or spinal cord injuries, because the jagged bone may sever nerves and blood vessels, damage tissues, and increase shock. Of course, threat of fire, necessity to abandon ship, or other similar situations may require that the victim be moved. But the principle that further damage could be done by moving the victim should always be kept in mind and considered against other factors.
7. When transporting an injured person, always see that the litter is carried feet forward no matter what the injuries are. This will enable the rear bearer to observe the victim for any respiratory obstruction or stoppage of breathing.
8. Keep the injured person comfortably warm — warm enough to maintain normal body temperature.

Very serious and mutilating injuries may require heroic first aid measures on your part. However, the greater the number of injuries, the more judgment and self-control you must exhibit to prevent yourself and well-intentioned bystanders from trying to do too much.

Electric Shock

Electric shock may cause anything from mild surprise to death. The effects of the shock are usually unknown. It is often hard to determine how an electrical shock victim has been affected.

SYMPTOMS OF ELECTRIC SHOCK.—When you find someone who has received a severe electric shock, the person's skin is usually very white or pale blue. In the case of victims with dark skin, it may be necessary to rely primarily on the color of the mucous membranes on the inside of the mouth or under the eye lid or under the nail bed. A person in or going into electric shock has a bluish color to these membranes instead of a healthy pink. The victim's pulse is very weak or absent. The person is unconscious, and usually the skin is burned. A stiffness of the body may happen in a few minutes. This is caused by the muscles reacting to shock. You should not consider this condition as rigor mortis. You should make sure the victim is no longer touching the live circuit and then start artificial respiration. People have recovered after body stiffness has set in.

RESCUE OF VICTIMS.—The rescue of a shock victim depends on your immediate administration of first aid.

WARNING

Do not attempt to administer first aid or come in physical contact with an electric shock victim before the power is shut off or, if the power cannot be shut off immediately, before the victim has been removed from the live conductor.

When attempting to administer first aid to an electric shock victim, proceed as follows:

Shut off the power.

If the power cannot be deactivated, remove the victim immediately, observing the following precautions:

—Protect yourself with dry insulating material. Use a dry board, a belt, dry clothing, or other available nonconductive material to free the victim (by pulling, pushing, or rolling) from the power-carrying object. **DO NOT TOUCH** the victim.

Immediately after you remove the victim from contact with the live circuit, administer artificial respiration/ventilation or cardiopulmonary resuscitation as necessary.

ANYONE WHO RECEIVES A SIGNIFICANT SHOCK SHOULD BE TAKEN TO SICK BAY OR A MEDICAL FACILITY AND OBSERVED FOR SEVERAL HOURS.

Artificial Ventilation

A person who has stopped breathing is not necessarily dead, but is in immediate critical danger. Life depends on oxygen that is breathed into the lungs and then carried by the blood to every body cell. Since body cells cannot store oxygen, and since the blood can hold only a limited amount (and only for a short time), death will surely result from continued lack of breathing.

The heart may continue to beat and the blood may still be circulated to the body cells for some time after breathing has stopped. Since the blood will, for a short time, contain a small supply of oxygen, the body cells will not die immediately. Thus, for a few minutes, there is some chance that the person's life may be saved. A person who has stopped breathing but who is still alive is said to be in a state of respiratory failure. The first aid treatment for respiratory failure is called artificial ventilation.

The purpose of artificial ventilation is to provide a method of air exchange until natural breathing is established. Artificial ventilation should be given only when natural breathing has stopped; it must **NOT** be given to any person who is still breathing. Do not assume that breathing has stopped merely because a person is unconscious or because a person has been rescued from the water, from poisonous gas, or from contact with an electric wire. Remember, **DO NOT GIVE ARTIFICIAL VENTILATION TO A PERSON WHO IS BREATHING NATURALLY**. If the victim does not begin spontaneous breathing after you use the head or jaw tilt techniques (discussed later) to open the airway, artificial ventilation must be attempted immediately. If ventilation is inadequate, one of the "thrust" methods of clearing the airway must be performed, followed by another attempt of artificial ventilation.

MOUTH-TO-MOUTH.—To perform this method of ventilation, clear the victim's mouth of obstructions (false teeth and foreign matter), place one hand under the victim's neck and the heel of the other hand on the forehead, and, using the thumb and index finger, pinch the nostrils shut. Tilt the head back to open the airway. Take a deep breath, cover the victim's mouth with your own, and blow into the victim's mouth. Then remove your mouth from the victim's to allow the victim to exhale. Observe the victim's chest for movement. If the victim has not started to breathe normally, start artificial ventilation with four quick ventilation in succession, allowing the lungs to only partially inflate. If the victim still does not respond, then you must fully inflate the victim's lungs at the rate of **12 TO 15 VENTILATIONS PER MINUTE, or ONE BREATH EVERY 5 SECONDS**.

MOUTH-TO-NOSE.—This type ventilation is effective when the victim has extensive facial or dental injuries or is very young, as it permits an effective air seal.

To administer this method, place the heel of one hand on the victim's forehead and use the other hand to lift the jaw. After sealing the victim's lips, take a deep breath, place your lips over the victim's nose, and blow. Observe the chest for movement and place your ear next to the victim's nose to listen for, or feel, air exchange. Again, you must continue your efforts at the rate of 12 to 15 ventilation per minute, or one breath every 5 seconds, until the victim can breathe without assistance.

NOTE: Sometimes during artificial ventilation, air enters the stomach instead of the lungs. This condition is called **GASTRIC DISTENTION**. It can be relieved by moderate pressure exerted with a flat hand between the navel and rib cage. Before applying pressure, turn the victim's head to the side to prevent choking on stomach contents that are often brought up during the process.

BACK PRESSURE ARM LIFT.—This method is an alternate technique used when other methods are not possible. Place the victim on the stomach, face to one side, neck hypo-extended, with hands under the head. Quickly clear the mouth of any foreign matter. Kneel at the victim's head and place your hands on the victim's back so that the heels of the hands lie just below a line between the armpits, with thumbs touching and fingers extending downward and outward. Rock forward, keeping your arms straight, and exert pressure almost directly downward on the victim's back, forcing air out of the lungs. Then rock backward, releasing the pressure and grasping the arms just above the elbows. Continue to rock backward, pulling the arms upward and inward (toward the head) until resistance and tension in the victim's shoulders are noted. This expands the chest, causing active intake of air (inspiration). Rock forward and release the victim's arms. This causes passive exiting of air (expiration). Repeat the cycle of *press, release, lift, and release* 10 to 12 times a minute until the victim can breathe naturally.

Cardiac Arrest and Cardiopulmonary Resuscitation

Cardiac arrest is the complete stoppage of heart function. If the victim is to live, action must be taken immediately to restore heart function.

In this situation, the immediate administration of cardiopulmonary resuscitation (CPR) by a rescuer using correct procedures greatly increases the chances of a victim's survival. To be effective, CPR must be started within 4 minutes of the onset of cardiac arrest. CPR consists of external heart compression and artificial ventilation. This compression is performed on the outside of the chest, and the lungs are ventilated either by mouth-to-mouth or mouth-to-nose techniques. The victim should be lying on a firm surface.

CAUTION

A rescuer who has not been properly trained should not attempt CPR. Everyone who works around electricity should be trained. (To learn CPR, consult a hospital corpsman.) Improperly done, CPR can cause serious damage. Therefore, it is never practiced on a healthy individual for training purposes; a training aid is used instead.

ONE RESCUER TECHNIQUE.—If a cardiac arrest is not witnessed, the rescuer must not assume that an arrest has occurred solely because the victim is lying on the floor and appears to be unconscious. First, try to arouse the victim. You can try shaking the victim's shoulders gently to obtain a response. Next, quickly check vital signs; if there is no response, apply artificial ventilation. Establish an open airway and ventilate the victim four times. Check the carotid (neck) pulse as shown in figure 1-1. If no pulse is felt and there are no visible signs of breathing, start CPR immediately.



Figure 1-1.—Feeling for the carotid pulse

To start external cardiac compression, place the victim on the back, establish an open airway, and kneel at right angles to the victim's body. Then locate the victim's sternum (breastbone). You have a choice of two methods of doing this. One method is to bare the chest and locate the sternum by drawing an imaginary line from one nipple to the other to identify the proper area of the sternum, which is darkened in figure 1-2. The other method is to locate the lower tip of the sternum with the index and middle fingers, placing the heels of your hands above your fingers in the darkened area.

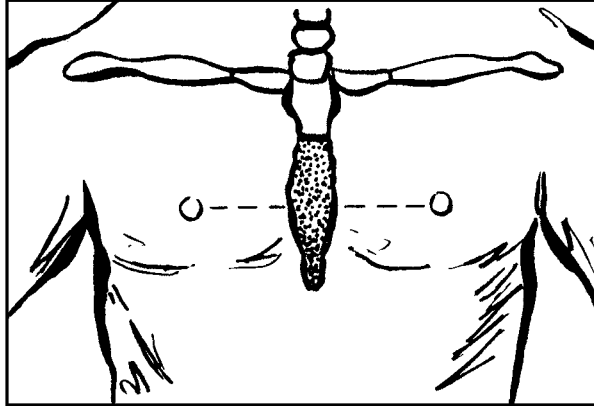

Figure 1-2.—Locating the sternum.

There is a small piece of cartilage at the lower end of the sternum (figure 1-2). A fracture of this area can damage the liver, causing hemorrhage (heavy bleeding) and death. When you place the heels of your hands on the victim's chest, make sure they are above the tip of the sternum.

Place the heel of one hand directly on the sternum and the heel of the other on top of the first. Figure 1-3, view A, shows this technique. Interlock your fingers and *keep them off the victim's chest!*

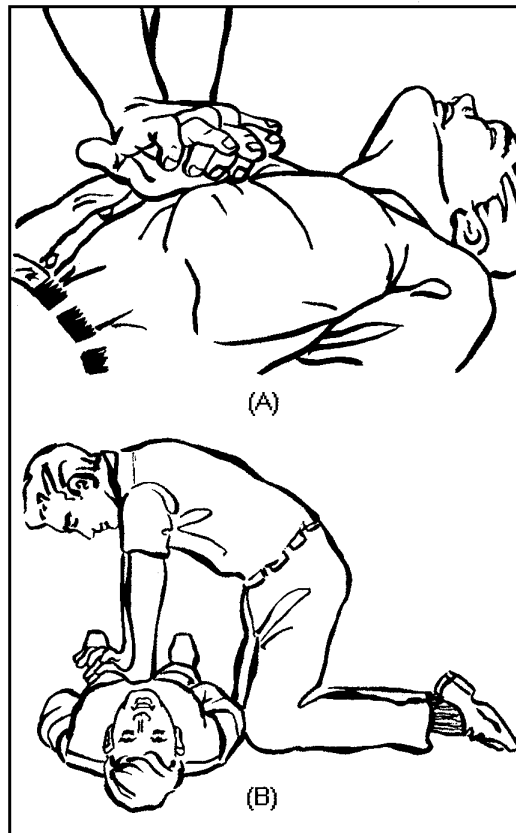

Figure 1-3.—Position for cardiac compression.

Lean or rock forward with elbows locked, and apply vertical pressure to depress the sternum (adult) 1 1/2 to 2 inches. View B depicts this. Then release the pressure, keeping hands in place. Administer 60 to 80 compressions per minute.

You will feel less fatigue if you use the proper technique, and a more effective compression will result.

Ineffective compression occurs when the elbows are not locked, the rescuer is not directly over the sternum, or the hands are improperly placed on the sternum.

When one rescuer performs CPR, as shown in figure 1-4, the ratio of compressions to ventilations is 15 to 2. After 15 compressions, you must give the victim 2 ventilations. This ratio must continue for four full cycles. Then check for pulse and breathing. If there are still no signs of recovery, continue CPR until the victim can breathe unassisted or you are relieved by medical personnel.



Figure 1-4.—One rescuer CPR technique.

Before reviewing the next technique, let's go over the steps to take in an unwitnessed cardiac arrest involving one rescuer.

1. Determine whether the victim is conscious.
2. Check the vital signs.
3. Ventilate four times (you may have to remove an airway obstruction at this time!).
4. Again check the vital signs; if none:
 - a. Begin compression-ventilation rate of 15 to 2 for four complete cycles.
 - b. Check pulse, breathing, and pupils. If no change
 - c. Continue compression-ventilation rate of 15 to 2 until victim is responsive or you are relieved by medical personnel.

TWO RESCUER TECHNIQUE.—If two people trained in CPR are on the scene, one must perform compressions while the other performs artificial ventilation. The ratio for two-person CPR is 5 compressions to 1 ventilation. One rescuer is positioned at the chest area and the other beside the victim's head. The rescuers should be on opposite sides of the victim.

To avoid confusion, one rescuer must be designated the leader. The leader must make the preliminary checks of the victim's vital signs and perform the initial four ventilations. The second rescuer will perform the compressions.

When CPR is started, the compressions should be given in a constant, methodical rhythm. The rescuer giving the compressions counts them out loud. As the fifth compression is released, the other rescuer ventilates the victim. The compressions should be continued while ventilation is being given.

Hemorrhage

Blood is circulated throughout the body by means of three different kinds of blood vessels: arteries, veins, and capillaries. Arteries are large vessels that carry the blood away from the heart; veins are large vessels that carry the blood back to the heart; and capillaries form a connecting network of smaller vessels between the arteries and the veins.

Hemorrhage (escape of blood) occurs whenever there is a break in the wall of one or more blood vessels. In most small cuts, only capillaries are injured. Deeper wounds result in injury to veins or arteries. Bleeding which is severe enough to endanger life seldom occurs except when arteries or veins are cut.

The average adult body contains about 5 quarts (4.75 liters) of blood. One pint of blood can usually be lost without harmful effect—in fact, this is the amount usually given by blood donors. However, the loss of 2 pints (.95 liter) will usually cause shock; shock becomes greater and greater as the amount of blood loss increases (shock will be discussed later in this chapter). If half the blood in the body is lost, death almost always results.

Capillary blood is usually brick red in color. If capillaries are cut, the blood oozes out slowly. Blood from veins is dark red. If a vein is cut, the blood escapes in a steady, even flow. If an artery near the surface is cut, the blood will gush out in spurts that are synchronized with the heartbeats; but if the cut artery is deeply buried, the bleeding will appear to be a steady stream. Arterial blood is usually bright red in color.

In actual practice, you might find it difficult to decide whether bleeding is from a vein or an artery; but the distinction is not usually important. The important thing to know is that bleeding must be controlled as quickly as possible.

METHODS OF CONTROLLING BLEEDING.—The only way to stop serious bleeding is by the application of pressure. In practically all cases, bleeding can be stopped if **PRESSURE** is applied **DIRECTLY TO THE WOUND**. If direct pressure does not stop the bleeding, pressure should be applied at the appropriate pressure point. In those very rare cases where bleeding is so severe that it cannot be controlled by either of these methods, pressure can be applied by means of a tight, constricting band called a tourniquet.

PROCEDURES.—The actual procedures you should use to stop bleeding are detailed in the following paragraphs:

Direct Pressure.—In almost every case, bleeding can be stopped by the application of pressure directly on the wound. Figure 1-5 is an example of direct pressure. Place a dressing (sterile or clean, if

possible) over the wound and firmly fasten it in position with a bandage. If bleeding does not stop, firmly secure another dressing over the first, or apply direct pressure with your hand to the dressing.

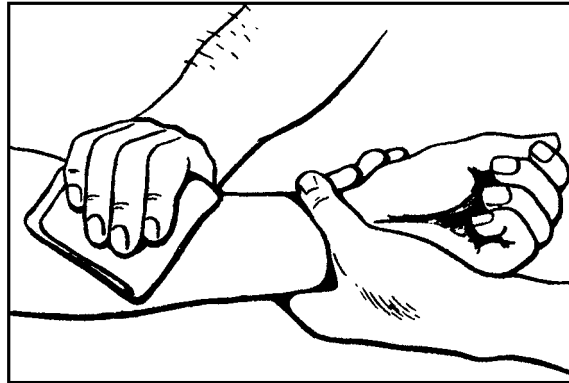

Figure 1-5.—Direct pressure.

In cases of severe hemorrhage, do not worry too much about the dangers of infection. The basic problem is to stop the flow of blood. If no material is available, simply apply pressure with your bare hand. Remember, **DIRECT PRESSURE** is the first method to use when you are trying to control hemorrhage.

Pressure Points.—Bleeding from a cut artery or vein may often be controlled by pressure applied to the appropriate pressure point. A pressure point is a place where the main artery to the injured part lies near the skin surface and over a bone. Pressure at such a point is applied with the fingers (digital pressure) or with the hand; no first aid materials are required. The object of the pressure is to compress the artery against the bone, thus shutting off the flow of blood from the heart to the wound.

There are 11 principal points on each side of the body where hand or finger pressure can be used to stop hemorrhage. These points are shown in figure 1-6.

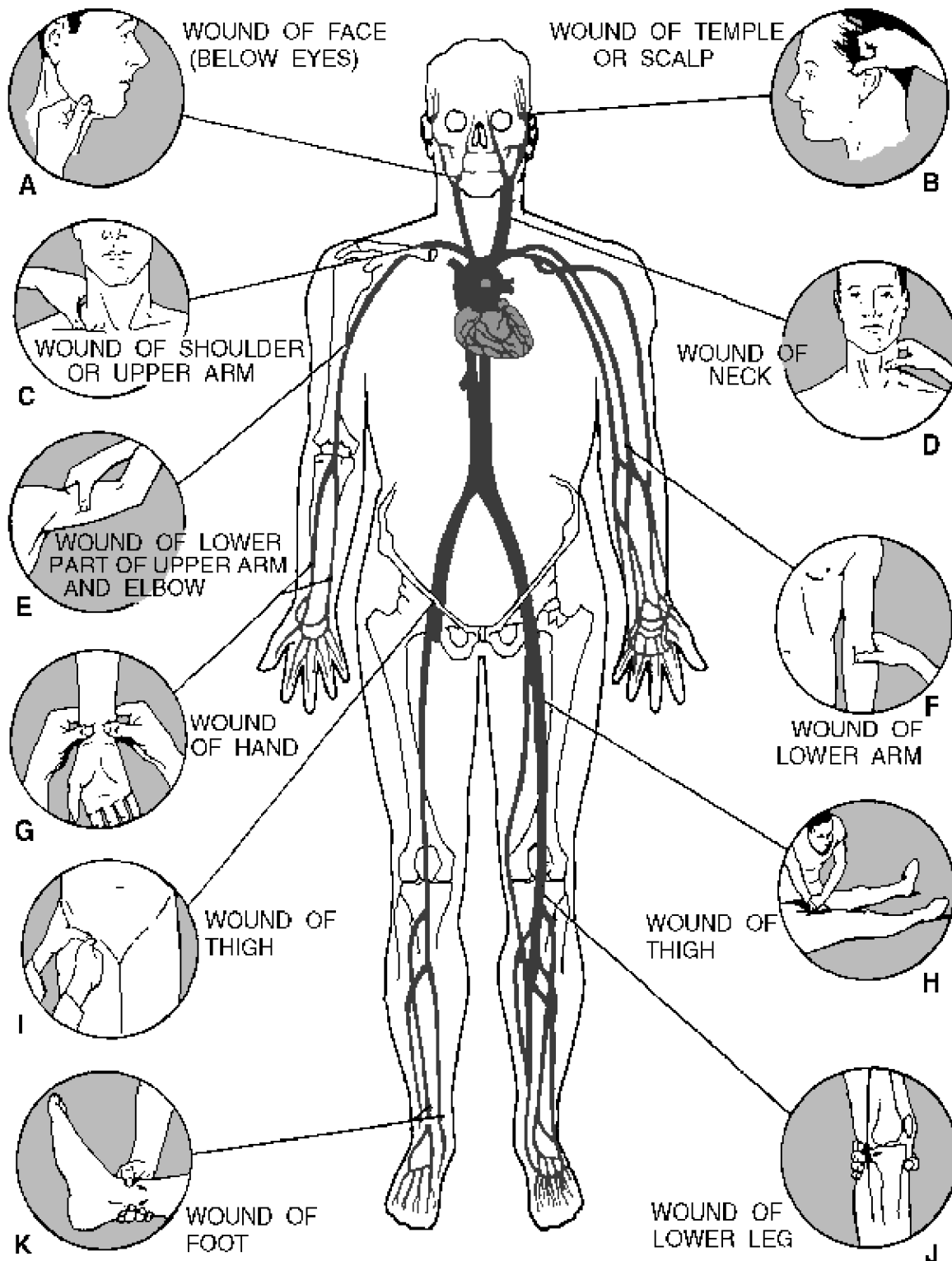

Figure 1-6.—Pressure points for control of bleeding.

You should memorize these pressure points so that you will know immediately which point to use for controlling hemorrhage from a particular part of the body. The correct pressure point is the one that is

(1) NEAREST THE WOUND and (2) BETWEEN THE WOUND AND THE MAIN PART OF THE BODY.

Applying finger pressure is very tiring, and it can seldom be maintained for more than 15 minutes. Pressure points are recommended for use while direct pressure is being applied to a serious wound. While pressure is being applied at the appropriate pressure point, an assistant can bandage the wound (or wounds). If available, a battle dressing should be used. Figure 1-7 shows the battle dressing and its use. After opening the dressing, be careful not to contaminate it. Place the compress portion over the wound, then bind it tightly in place with the attached straps. If bleeding continues to be severe even after direct pressure and pressure points have been used, you may have to apply a tourniquet.

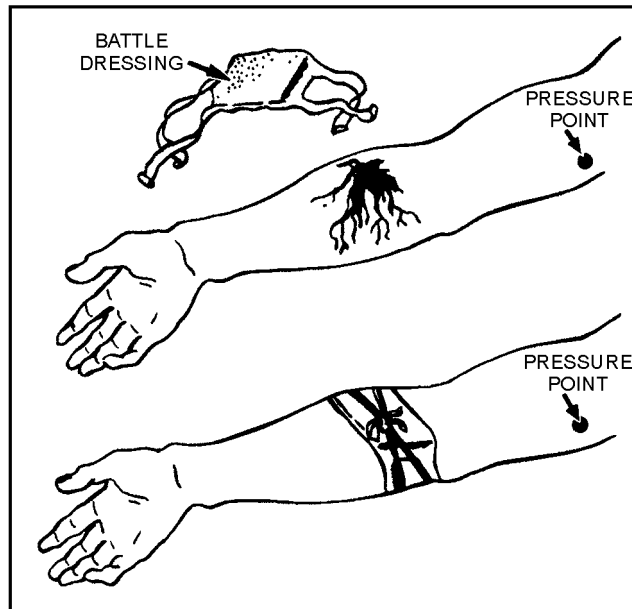

Figure 1-7.—Battle dressing.

Use of the Tourniquet.—A tourniquet is a constricting band that is used to cut off the supply of blood to an injured limb. It cannot be used to control bleeding from the head, neck, or trunk, since its use in these locations would result in greater injury or death. A tourniquet should be used *only* if the control of hemorrhage by other means proves to be impossible.

Basically, a tourniquet consists of a pad, a band, and a device for tightening the band so that the blood vessels will be compressed. There are several different kinds of ready-made tourniquets. A variety of materials can be used to improvise tourniquets. Any round, smooth pressure object may be used for the pad — a compress, a roller bandage, a stone, a rifle shell — and any long, flat material may be used as the band. However, the band must be flat: belts, stockings, flat strips of rubber, or neckerchiefs can be used; but rope, wire, string, or very narrow pieces of cloth should not be used because they will cut into the flesh. A short stick may be used to twist the band, thus tightening the tourniquet.

A tourniquet must always be applied *above* the wound — that is, toward the body — and it must be applied as close to the wound as practicable.

The best object to be used for the pad is either a bandage, a compress, or some similar pressure object. The pad goes under the band. It must be placed directly over the artery, or it will actually decrease the pressure on the artery and thus allow greater flow of blood. If a tourniquet placed over a pressure object does not stop the bleeding, the pressure object is probably in the wrong place. If this occurs, shift

the object around until the tourniquet, when tightened, will control the bleeding. If no suitable pressure object is available, use the tourniquet without it.

To apply an emergency tourniquet made from something like a neckerchief, wrap the material once around the limb and tie an overhand knot; place a short stick on the overhand knot and tie a square knot over it. Then twist the stick rapidly to tighten the tourniquet. The stick may be tied in place with another strip of material. Figure 1-8 shows how to apply a tourniquet.

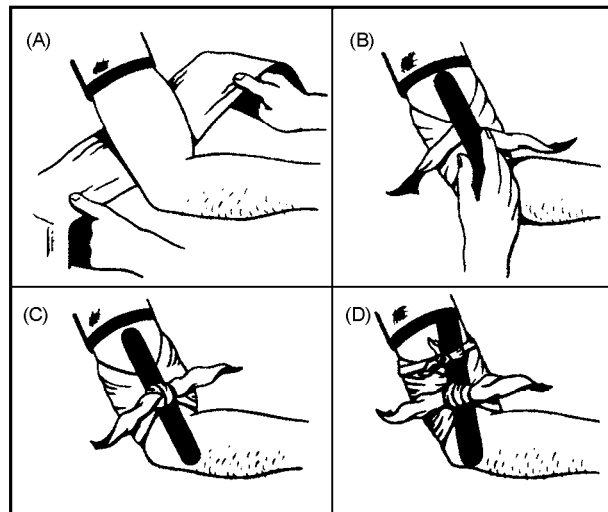

Figure 1-8.—Applying a tourniquet.

To be effective, a tourniquet must be tight enough to stop the blood flowing to the limb. If the pressure from the tourniquet is less than the arterial pressure, arterial bleeding will continue. Also, insufficient tourniquet pressure may actually increase the amount of bleeding from the veins. So be sure to draw the tourniquet tight enough to stop the bleeding. However, do not make it any tighter than necessary.

After you have brought the bleeding under control with the tourniquet, apply a sterile compress or dressing to the wound and fasten it in position with a bandage.

CAUTION

NEVER apply a tourniquet unless the hemorrhage is so severe that it cannot be controlled in any other way. By the time the tourniquet is required, the victim will have lost a considerable amount of blood; therefore, once a tourniquet has been applied, it should be released only by medical personnel.

Here are the points to remember when you use a tourniquet:

- Do not use a tourniquet unless you cannot control the bleeding by any other means.
- Do not use a tourniquet for bleeding from the head, face, neck, or trunk. Use it only on the limbs.
- Always apply a tourniquet *above the wound* and as close to the wound as possible.

- Be sure you draw the tourniquet tight enough to stop the bleeding, but do not make it any tighter than necessary.
- Do not loosen a tourniquet after it has been applied except in extreme emergency.
- Do not cover a tourniquet with a dressing. If you must cover the injured person in some way, make sure that all other people concerned with the case know about the tourniquet. Using crayon, magic marker, or blood, mark a large T on the victim's forehead or on a medical tag attached to the wrist.

Shock

If you've ever hit your finger with a hammer and felt — in addition to the pain — weak, dizzy, and nauseous, then you have experienced a mild form of shock. In such an instance, the symptoms appear immediately after the injury; but they may not show up for several hours.

Shock is a condition in which blood circulation is seriously disturbed. Crushed or fractured bones, burns, prolonged bleeding, and asphyxia all cause shock. It may be slight or it may be severe enough to cause death. Because all injuries will result in some form of shock, you must learn its symptoms and know how to treat the victim.

HOW TO RECOGNIZE SHOCK.—A person who is going into shock may show quite a few signs or symptoms, some of which are indicated in figure 1-9 and are discussed below. Remember, however, that signs of shock do not always appear at the time of the injury; indeed, in many serious cases they may not appear until hours later.

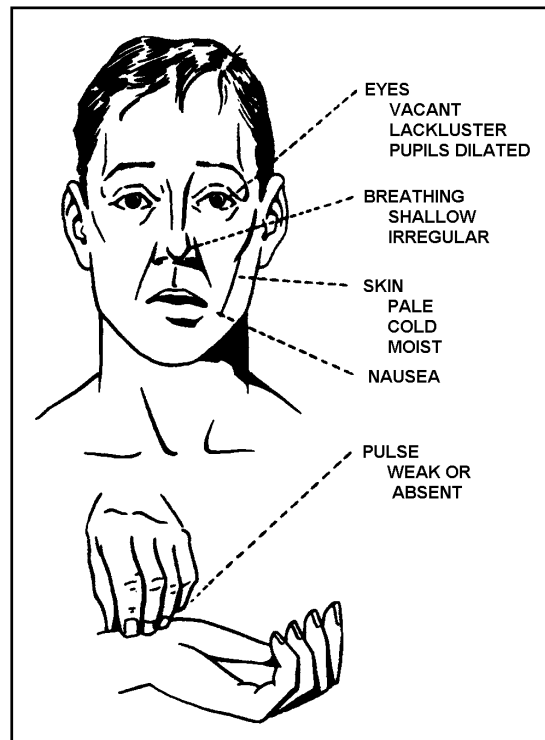

Figure 1-9.—Symptoms of shock.

The symptoms of a person suffering from shock are caused, directly or indirectly, by the disturbance of the circulation of the blood. The pulse is weak and rapid. Breathing is likely to be shallow, rapid, and irregular, because the poor circulation of the blood affects the breathing center in the brain. The temperature near the surface of the body is lowered because of the poor blood flow; so the face, arms, and legs feel cold to the touch. Sweating is likely to be very noticeable. A person in shock is usually very pale, but in some cases the skin may have a bluish or reddish color. As mentioned previously when we were discussing electric shock, in the care of victims with dark skin, it may be necessary to rely primarily on the color of the mucous membranes on the inside of the mouth or under the eyelid or under the nail bed. A person in or going into shock has a bluish color to these membranes instead of a healthy pink. The pupils of the eyes are usually dilated (enlarged).

A conscious person in shock may complain of thirst and have a feeling of weakness, faintness, or dizziness. The victim may feel nauseous, restless, frightened, and/or anxious. As shock deepens, these signs gradually disappear and the victim becomes less and less responsive to what is going on. Even pain may not arouse the shock victim. Finally, the victim may become unconscious.

You will not likely see all these symptoms of shock in any one case. Some of them appear only in late stages of shock when the disturbance of the blood flow has become so great that the person's life is in serious danger. Sometimes the signs of shock may be disguised by other signs of injury. You must know what symptoms indicate the presence of shock, but do not ever wait for symptoms to develop before beginning the treatment for shock. Remember, **EVERY SERIOUSLY INJURED PERSON IS LIKELY TO DEVELOP SERIOUS SHOCK.**

PREVENTION AND TREATMENT OF SHOCK.—You should begin treatment for shock as soon as possible. Prompt treatment may prevent the occurrence of shock or, if it has already developed, prevent its reaching a critical point. Keep the victim lying down and warm. If conscious, the victim should be encouraged and assured that expert medical help will arrive soon.

KEEP AN INJURED PERSON WARM ENOUGH FOR COMFORT, BUT DO NOT LET THE VICTIM BECOME OVERHEATED.

The best position to use for the prevention or the treatment of shock is one which encourages the flow of blood to the brain. If the injured person can be placed on his/her back on a bed, a cot, or a stretcher, you can raise the lower end of the support about 12 inches so that the feet will be higher than the head. The circumstances of the accident may prevent the use of a bed, a cot, or a stretcher. In such cases, you might still be able to raise the feet and legs enough to help the blood flow to the brain. Sometimes you can take advantage of a natural slope of ground and place the casualty so that the head is lower than the feet.

In every case, of course, you will have to consider what type of injury is present before you can decide on the best position. For example, a person with a chest wound may have so much trouble breathing that you will have to raise the head slightly. If the face is flushed rather than pale, or if you have any reason to suspect a head injury, do not raise the feet; instead, you should keep the head level with or slightly higher than the feet. If the person has broken bones, you will have to judge what position would be best both for the fractures and for shock. A fractured spine must be immobilized before the victim is moved at all, if further injuries are to be avoided. If you have any doubts about the correct position to use, have the victim lie flat on his/her back. **THE BASIC POSITION FOR TREATING SHOCK IS ONE IN WHICH THE HEAD IS LOWER THAN THE FEET.** Do the best you can under the particular circumstances to get the injured person into this position. In any case, never let a seriously injured person sit, stand, or walk around.

Liquids should be administered sparingly, and not at all if medical attention will be available within a short time. If necessary, small amounts of warm water, tea, or coffee may be given to a victim who is conscious. Persons having serious burns are an exception. Burn victims require large amounts of fluids. Water, tea, fruit juices, and sugar water may be given freely to a victim who is conscious, able to swallow, and has no internal injuries. Slightly salted water is also beneficial. Alcohol must never be given to a person in shock.

An injured person may or may not be in pain. The amount of pain felt depends in part on the person's physical condition and the type of injury. Extreme pain, if not relieved, can increase the degree of shock. Make the victim as comfortable as possible. Fractures should be immobilized and supported. Immobilization greatly reduces, and sometimes eliminates, pain. Normally, you should not administer drugs, but aspirin may be given for mild pain.

Heat is important in the treatment of shock to the extent that the injured person's body heat must be conserved. Exposure to cold, with resulting loss of body heat, can cause shock to develop or to become worse. You will have to judge the amount of covering to use by considering the weather and the general circumstances of the accident. Often a light covering will be enough to keep the casualty comfortable. Wet clothing should be removed and dry covering provided, even on a hot day. Use blankets or any dry material to conserve body heat. Artificial means of warming (hot water bottles, heated bricks, heated sand) should not ordinarily be used. Artificial heat may cause loss of body fluids (by sweating) and it brings the blood closer to the surface, thus defeating the body's own efforts to supply blood to the vital organs and to the brain. Also, the warming agent may burn the victim.

Burns

The seriousness of a burn depends on two factors: the extent of the burned area and the depth of the burn. Shock can be expected from burns involving 15 percent or more of the body. Burns involving 20 percent endanger life. Without adequate treatment, burns of over 30 percent are usually fatal. The depth of the injury determines whether it is a first, second, or third degree burn.

First degree burns are mildest. Symptoms are slight pain, redness, tenderness, and increased temperature of the affected area.

Second degree burns are more serious. The inner skin may be damaged, resulting in blistering, severe pain, some dehydration, and possible shock.

Third degree burns are worst of all. The skin is destroyed, and possibly also the tissue and muscle beneath it. The skin may be charred, or it may be white and lifeless (from scalds). After the initial injury, pain may be less severe because of destroyed nerve ends. The person may have chills. Some form of shock will result.

Probably the most important aspect is the extent of the burned area. A first degree burn covering a large area could be more serious than a small third degree burn. A sunburn, for example, ranging from mild to serious, is easily obtained, particularly if you are not accustomed to the exposure. If you were to fall asleep while sunbathing, second degree burns, or even third degree burns of a possibly fatal nature, could result.

The most effective immediate treatment of burns and of pain is to immerse the burned area in cold water or to apply cold compresses if immersion is impracticable. Cold water not only minimizes pain, but also reduces the burning effect in the deeper layers of the skin. Gently pat dry the area with lint-free cloth or gauze. Aspirin is also effective for the relief of pain. Continue treatment until no pain is felt when the burned area is exposed to the air.

Burn victims require large amounts of water, which should be slightly salted. Because of the nature of the injury, most burns are sterile. The best treatment for uninfected burns, therefore, is merely to protect the area by covering it with the cleanest (preferably sterile) dressing available. Never apply ointments to a burn nor use petrolatum gauze.

Do not attempt to break blisters or to remove shreds of tissue or adhered particles of charred clothing. Never apply a greasy substance (butter, lard, or petroleum jelly), antiseptic preparations, or ointments. These may cause further complications and interfere with later treatment by medical personnel.

Heatstroke

Sunstroke is more accurately called heatstroke since a person does not have to be exposed to the sun for this condition to develop. It is a less common but far more serious condition than heat exhaustion, since it carries a 20 percent fatality rate. The main feature of heatstroke is the extremely high body temperature, 105° F (41° C) or higher, that accompanies it. In heatstroke, the victim has a breakdown of the sweating mechanism and is unable to eliminate excessive body heat built up while exercising. If the body temperature rises too high, the brain, kidneys, and liver may be permanently damaged.

Sometimes the victim may have preliminary symptoms, such as headache, nausea, dizziness, or weakness. Breathing will be deep and rapid at first, later shallow and almost absent. Usually the victim will be flushed, very dry, and very hot. The pupils will be constricted (pinpoint) and the pulse fast and strong. Figure 1-10 compares these symptoms with those of heat exhaustion.

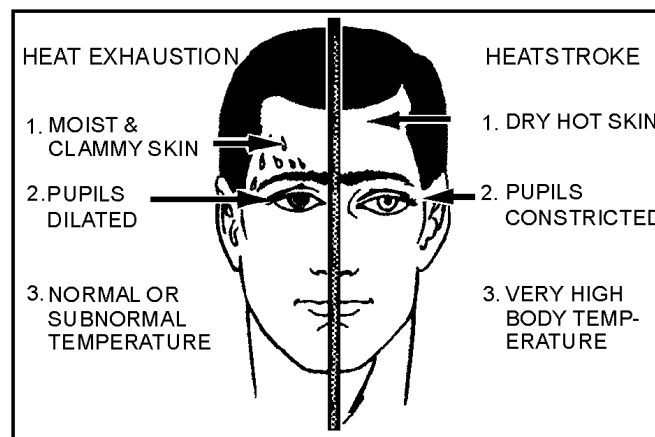

Figure 1-10.—Symptoms of heatstroke and heat exhaustion.

When you provide first aid for heatstroke, remember that this is a true life-and-death emergency. The longer the victim remains overheated, the higher the chances of irreversible body damage or even death occurring. First aid treatment for heatstroke is designed to reduce body heat.

Reduce body heat immediately by dousing the body with cold water, or applying wet, cold towels to the whole body. Move the victim to the coolest possible place and remove as much clothing as possible. Maintain an open airway. Place the victim on his/her back, with the head and shoulders slightly raised. If cold packs are available, place them under the arms, around the neck, at the ankles, and in the groin. Expose the victim to a fan or air-conditioner since drafts will promote cooling. Immersing the victim in a cold water bath is also effective. Give the victim (if conscious) cool water to drink. Do not give any hot

drinks or stimulants. Get the victim to a medical facility as soon as possible. Cooling measures must be continued while the victim is being transported.

Heat Exhaustion

Heat exhaustion (heat prostration or heat collapse) is the most common condition caused by working or exercising in hot spaces. Heat exhaustion produces a serious disruption of blood flow to the brain, heart, and lungs. This causes the victim to experience weakness, dizziness, headache, loss of appetite, and nausea.

Signs and symptoms of heat exhaustion are similar to those of shock: the victim will appear ashen gray; the skin will be cold, moist, and clammy; and the pupils of the eyes may be dilated (enlarged). The vital (blood pressure, temperature, pulse, and respiration) signs usually are normal; however, the victim may have a weak pulse together with rapid and shallow breathing. Body temperature may be below normal.

You should treat heat exhaustion victims as if they were in shock. Loosen the clothing, apply cool wet cloths, move the victim to either a cool or an air-conditioned area, and fan the victim. Do not allow the person to become chilled. If the victim is conscious, administer a solution of 1 teaspoon of salt dissolved in a quart of cool water. If the victim vomits, do not give any more fluids. Transport the victim to a medical facility as soon as possible.

HELPFUL INFORMATION

The second part of this handbook has been compiled to provide the technician with a collection of helpful information. Included are many commonly used formulas, data tables, and general maintenance hints used in, with, and around electricity.

BASIC ELECTRICAL FORMULAS

Basic electrical formulas are included to aid you in solving electrical problems. These formulas are for capacitance, current, inductance, power, reactance, impedance, resistance, voltage, and transformers. Additional formulas can be found in the appropriate NEETS module.

Capacitance

The property of an electrical device to store energy is **CAPACITANCE**. This energy is stored in a way to oppose a change in voltage. A **CAPACITOR** is used to store this electrical energy. The **FARAD** is the basic unit of measurement of capacitance.

Formulas for capacitance:

$$C = \frac{Q}{E}$$

C = capacitance in farads

Q = coulombs (a unit of charge equal to 6.28×10^{18} electrons)

E = volts

$$C = 0.2249 \frac{(kA)}{d}$$

A = area of one plate, in square inches

C = capacitance in picofarads

d = distance between the plates in inches

k = dielectric constant of the insulating material

0.2249 is a constant resulting from conversion from metric to British units

Common insulating materials for capacitors and their dielectric constant are:

MATERIAL	CONSTANT
Vacuum	1.0000
Air	1.0006
Paraffin paper	3.5
Glass	5 to 10
Mica	3 to 6
Rubber	2.5 to 35
Wood	2.5 to 8
Glycerine (15° C)	56
Petroleum	2
Pure Water	81

The time to charge a capacitor to 63.2 percent of applied voltage or discharge it to 36.8 percent of its initial voltage is known as the TIME CONSTANT (t) of the circuit. Figure 1-11 shows an RC time constant chart. One time constant (t) in seconds equals $R \times C$, with R in ohms and C in farads.

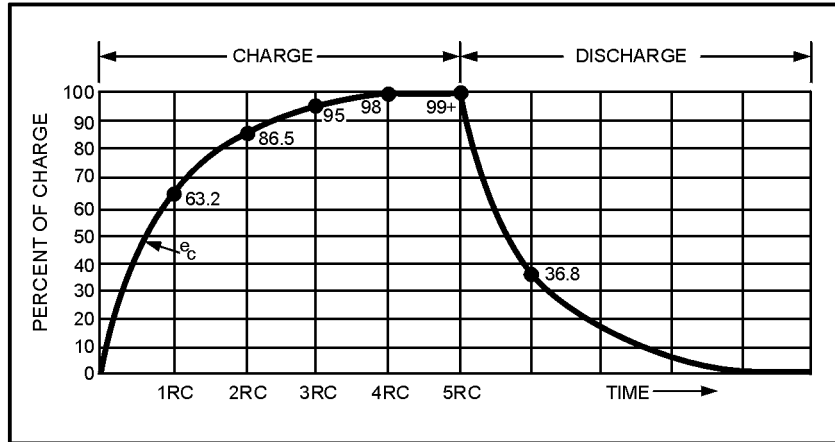

Figure 1-11.—RC time constants.

Figure 1-12 is a universal time constant chart for RC and LR circuits. One time constant (t) in seconds equals $R \times C$, with R in ohms and C in farads, or L/R with L in henries and R in ohms.

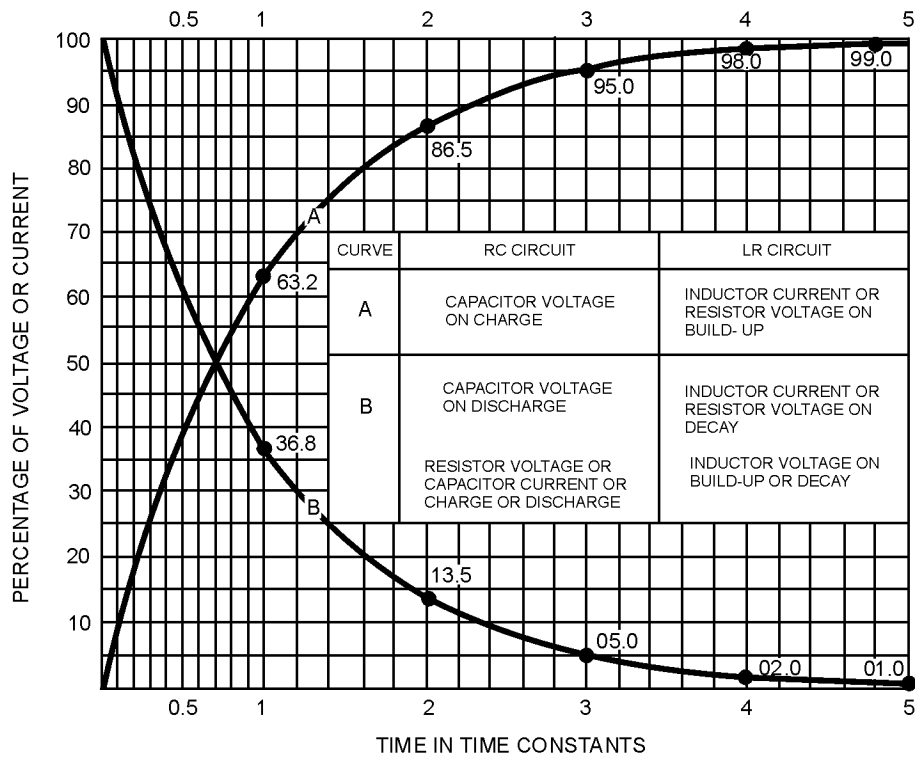

Figure 1-12.—Universal time constant chart for RC and LR circuits.

Adding capacitors in series:

If only two capacitors are used:

$$C_T = \frac{C_1 \times C_2}{C_1 + C_2}$$

If more than two capacitors are used:

$$C_T = \frac{1}{\frac{1}{C_1} + \frac{1}{C_2} + \frac{1}{C_3} + \dots + \frac{1}{C_n}}$$

Adding capacitors in parallel:

$$C_T = C_1 + C_2 + C_3 + \dots + C_n$$

CAUTION

Capacitors retain an electrical charge. Be sure to discharge all capacitors and circuits containing capacitors before working on them.

A more detailed description of capacitors and capacitance can be found in NEETS, Module 2, *Introduction to Alternating Current and Transformers*.

Current

Electrons (negative charges) move through a conductor when an electric field is applied. Electron current is defined as the directed flow of electrons from negative to positive.

Current is measured in AMPERES (AMP). One amp of current flows when one coulomb (6.28×10^{18} electrons) passes a point in one second.

The Ohm's law formulas for current are:

$$I = \frac{E}{R}$$

I = current in amps

E = voltage in volts

R = resistance in ohms

$$I = \sqrt{\frac{P}{R}}$$

P = power in watts

$$I = \frac{P}{E}$$

Ac current formulas are:

Average current

$$I_{avg} = 0.636 \times I_{max}$$

Effective current

$$I_{eff} = 0.707 \times I_{max}$$

Maximum current

$$I_{max} = 1.414 \times I_{eff}$$

Ohm's law

$$I_{eff} = \frac{E_{eff}}{R}$$

$$I_{avg} = \frac{E_{avg}}{R}$$

$$I_{max} = \frac{E_{max}}{R}$$

Ohm's law for reactive circuits:

$$I = \frac{E}{X_L} \text{ or } I = \frac{E}{X_C}$$

Ohm's law for circuits containing resistance and reactance:

$$I = \frac{E}{Z}$$

Current across the primary (I_p) of a transformer:

$$I_p = \frac{E_s I_s}{E_p}$$

Current across the secondary (I_s):

$$I_s = \frac{E_p I_p}{E_s}$$

NOTE

Human reaction to electrical shock is determined by the amount of current flowing through the body. A 100-milliampere shock for 1 second is usually fatal!

More information about current can be found in NEETS, Module 1, *Introduction to Matter, Energy, and Direct Current*.

Inductance

Inductance is the characteristic of an electrical conductor that opposes a change in electrical current. The symbol for inductance is L and the basic unit of measurement is the *HENRY*(H).

An inductor has an inductance of 1 henry if an electromotive force (emf) of 1 volt is induced in the inductor when the current through the inductor is changing at the rate of one ampere per second.

Mathematically:

$$E_{\text{ind}} = L \frac{\Delta I}{\Delta t}$$

E_{ind} = induced voltage

L = inductance in henrys

ΔI = change in current in amperes

Δt = change in time in seconds

Mutual inductance:

$$M = K\sqrt{L_1L_2}$$

M = mutual inductance in henrys

K = coefficient of coupling

L_1L_2 = inductance of coils in henrys

Series inductors without magnetic coupling:

$$L_T = L_1 + L_2 + L_3 \dots + L_n$$

L_T = total inductance in henrys

L_1, L_2, L_3 = inductance of each inductor

L_n = any number of additional inductors ($L_4, L_5,$
and so forth) that could be used

Series inductors with magnetic coupling:

$$L_T = L_1 + L_2 \pm 2M$$

M = mutual inductance between two inductors;

plus sign is used when the magnetic fields
of two inductors aid each other and minus
when they oppose.

Parallel inductors without coupling:

$$\frac{1}{L_T} = \frac{1}{L_1} + \frac{1}{L_2} + \frac{1}{L_3} \dots + \frac{1}{L_n}$$

Provided the coefficient of coupling between inductors is zero.

Resistive/inductive circuit:

The time required for the current in an inductor to increase to 63.2 percent of its final value or decrease to 36.8 percent is known as the time constant.

Mathematically expressed:

$$t = \frac{L}{R}$$

t = seconds
 L = henrys
 R = ohms

Figure 1-13 shows an L/R time constant chart.

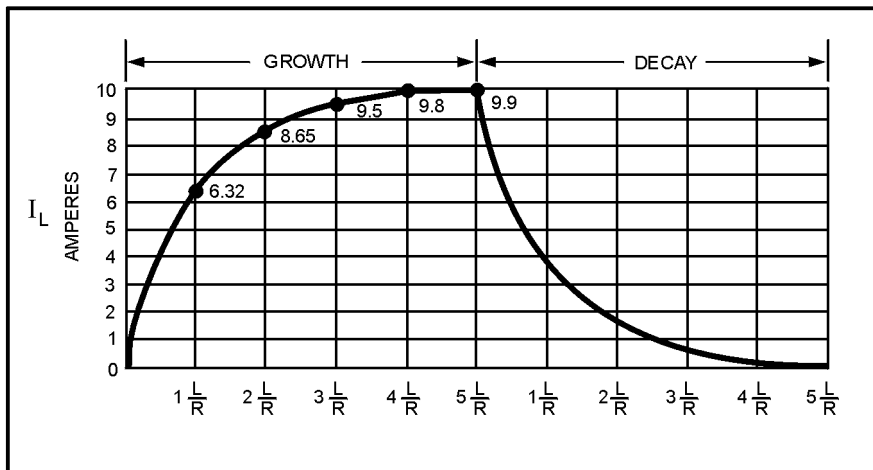

Figure 1-13.—L/R time constant.

You may want to refer back to figure 1-12, which shows the L/R relationship using the universal time constant chart.

Inductive reactance:

$$X_L = 2 \pi f L$$

X_L = reactance in ohms

$$\pi = 3.1416$$

f = frequency in hertz

L = inductance in henrys

Ohm's law for reactive circuit:

$$I = \frac{E}{X_L}$$

You can find more information about inductance in NEETS, Module 2, *Introduction to Alternating Current and Transformers*.

Power

Electrical **POWER** pertains to the rate at which work is being done. Work is done whenever a force causes motion. The instantaneous rate at which work is done is called the electric power rate and is measured in **WATTS**.

Formulas for power in dc circuits are:

$$P = I E$$

$$P = I^2 R$$

$$P = \frac{E^2}{R}$$

For ac circuits:

True power:

$$P = (I_R)^2 R$$

True power is measured in watts.

I_R = resistive current in amperes.

R = resistance in ohms.

Reactive power:

$$Q = (I_X)^2 X$$

Reactive power is measured in volt - amperes - reactive.

I_X = reactive current in amps.

X = total reactance in ohms.

Another way to calculate reactive power is:

Reaction power:

$$Q = (I_L)^2 X_L - (I_C)^2 X_C$$

or

$$Q = (I_C)^2 X_C - (I_L)^2 X_L$$

Subtract the smaller from the larger:

I_C = capacitive current in amperes

X_C = capacitive reactance in ohms

I_L = inductive current in amperes

X_L = inductive reactance in ohms

Apparent power:

$$s = (I_z)^2 Z$$

Apparent power is measured in volt - amperes (VA).

I_z = impedance current in amperes

Z = impedance in ohms

or

$$S = (\text{true power})^2 + (\text{reactive power})^2$$

Power factor ($\cos \Theta$):

$$\cos \Theta = \frac{\text{true power}}{\text{apparent power}}$$

or

$$\cos \Theta = \frac{(I_R)^2 R}{(I_z)^2 Z}$$

or in a series circuit :

$$\cos \Theta = \frac{R}{Z}$$

$\cos \Theta$ is represented as a decimal or percentage.

You can find more detailed information about power in NEETS, Module 2, *Introduction to Alternating Current and Transformers*.

Reactance

REACTANCE is the result of the difference between the values of X_C (capacitive reactance) and X_L (inductive reactance). Reactance is represented by the letter X and its basic measurement is in ohms.

The formula for reactance is:

$$X = X_L - X_C \text{ or } X = X_C - X_L$$

If you want more detailed information on reactance, look in NEETS, Module 2, *Introduction to Alternating Current and Transformers*.

Impedance

IMPEDANCE is the combined opposition of current flow by reactance and resistance and is represented by the symbol Z .

Formulas for finding impedance:

$$Z = \sqrt{R^2 + (X_L - X_C)^2}$$

or

$$Z = \sqrt{R^2 + (X_C - X_L)^2}$$

or

$$Z = \sqrt{R^2 + X^2}$$

Resistance

RESISTANCE is the opposition to current flow. It is measured in ohms and is represented by the letter R.

Formulas for resistance:

$$R = \frac{E}{I}$$

$$R = \frac{E^2}{P}$$

$$R = \frac{P}{I^2}$$

Voltage

VOLTAGE exists when a charge exists between two bodies. When a one coulomb charge exists, one unit of electrical potential energy is created. This is called a difference of potential, an electromotive force, or a voltage. It is measured in volts and represented by the letter E.

Formulas for voltage:

$$E = IR$$

$$E = \frac{P}{I}$$

$$E = \sqrt{PR}$$

Formulas for ac circuits :

(Average voltage)

$$(E_{avg} = 0.636 \times E_{max})$$

(Effective voltage)

$$E_{eff} = 0.707 \times E_{max}$$

(Maximum voltage)

$$E_{max} = 1.414 \times E_{eff}$$

Voltage across the primary of a transformer:

$$E_p = \frac{E_s N_p}{N_s}$$

Voltage across the secondary of a transformer:

$$E_s = \frac{E_p N_s}{N_p}$$

Transformers

A **TRANSFORMER** is a device that transfers electrical energy from one circuit to another by electromagnetic induction (transformer action). Voltage induced into the secondary from the primary is determined by the turns ratio.

Turns ratio formula:

$$\frac{E_s}{E_p} = \frac{N_s}{N_p}$$

or

$$E_p N_s = E_s N_p$$

transposing:

$$E_s = \frac{E_p N_s}{N_p}$$

Where :

E_s = voltage induced in the secondary

E_p = voltage applied to the primary

N_s = number of turns in the secondary

N_p = ampere - turns in the secondary winding

Turns and current ratios:

$$I_p N_p = I_s N_s$$

$I_p N_p$ = ampere - turns in the primary winding

$I_s N_s$ = ampere - turns in the secondary winding

By dividing both sides of the equation by $I_p N_s$, you obtain:

$$\frac{N_p}{N_s} = \frac{I_s}{I_p}$$

Since:

$$\frac{E_s}{E_p} = \frac{N_s}{N_p}$$

Then:

$$\frac{E_p}{E_s} = \frac{N_p}{N_s}$$

And:

$$\frac{E_p}{E_s} = \frac{I_s}{I_p}$$

Where:

E_p = voltage applied to the primary in volts

E_s = voltage across the secondary in volts

I_p = current in the primary in amperes

I_s = current in the secondary in amperes

Transformer power:

$$P_s = P_p - P_L$$

P_s = power delivered to the load by the secondary

P_p = power delivered to the primary by the source

P_L = power losses in the transformer

Transformer efficiency :

$$\text{Efficiency in (\%)} = \frac{P_o}{P_i} \times 100$$

Where:

P_o = total output power delivered to the load

P_i = total input power

Impedance matching transformers :

$$\frac{N_p}{N_s} = \sqrt{\frac{Z_p}{Z_s}}$$

WARNING

Transformers are often used to STEP-UP voltage. You may find a low voltage across the primary and a much higher voltage across the secondary. Use extreme caution, especially when working around television and other crt high voltage transformers. They often step voltages up to, or in excess of, 30,000 volts.

BASIC ELECTRONICS FORMULAS

Basic electronics formulas are included to aid you in solving any electronics problem that you may encounter. These formulas are for antennas, resonance, transistors, vacuum tubes, wavelength, and radar. Additional formulas may be found in the appropriate NEETS module.

Antennas

An antenna is a conductor or a group of conductors used either for radiating electromagnetic energy into space or collecting it from space or both.

Antenna gain remains the same for the antenna whether it is transmitting or receiving. Antenna gain (G) can be described as the effectiveness of a directional antenna in a particular direction, compared to a standard or reference antenna. Some antenna formulas are shown below:

Gain formula :

$$G = KD$$

K = radiation efficiency factor ($K \leq 1$)

D = directivity

Effective aperture :

$$A_e = \frac{W}{P}$$

W = power delivered to a matched load

P = power density

Also :

$$A_e = \frac{\lambda^2 G}{4\pi}$$

λ = wavelength (covered in depth later in this section)

G = gain

Directivity of an antenna :

$$D = \frac{U_m}{U_o}$$

U_m = maximum radiation intensity

U_o = average radiation intensity

Also :

$$D = \frac{U_m}{W / 4 \pi} = \frac{4 \pi U_m}{W}$$

W = total power radiated

Field strength :

$$E = \frac{5870P}{D}$$

E = field intensity in millivolts

P = transmitter power in watts

D = distance in miles

Antenna length (L) :

(Half-wave up to 30 megahertz)

$$L(\text{feet}) = \frac{492 \times 0.95}{f(\text{MH}_z)} = \frac{468}{f(\text{MH}_z)}$$

(Half-wave above 30 megahertz)

$$L(\text{feet}) = \frac{492 \times .94}{f(\text{MH}_z)} = \frac{462}{f(\text{MH}_z)}$$

$$L(\text{inches}) = \frac{5540}{f(\text{MH}_z)}$$

WARNING

Rf voltages may be induced in ungrounded metal objects such as wire guys, wire cables (hawsers), handrails, or ladders. You could receive a shock or rf burn if you come in contact with these objects. Obtain proper permission prior to going topside or "working aloft."

Rf burns are usually deep, penetrating, and third degree. They must heal from the inside out. If you are burned, seek medical attention. A person in an RF field will usually have a body temperature rise. The eyes and reproductive organs are especially susceptible to RF energy. Read and heed all warning signs!

You can find more information about antennas in NEETS, Module 10, *Introduction to Wave Propagation, Transmission Lines, and Antennas*.

Resonance

RESONANCE is a condition that exists in a circuit when inductance, capacitance, and the applied frequency are such that inductive reactance and capacitive reactance cancel each other.

Formula for resonant frequency (f_r):

$$f_r = \frac{1}{2\pi\sqrt{LC}}$$

Where:

f_r = resonant frequency in hertz

L = inductance in henrys

C = capacitance in farads

π (pi) = 3.1416

NOTE: The formula for resonance is the same for series or parallel circuits when $X_L = X_C$.

Transistors

Semiconductor devices that have three or more elements are called **TRANSISTORS**. The term is derived from **TRANS**fer and res**ISTOR**. This term describes the operation of the transistor — the transfer of an input signal current from a low-resistance circuit to a high-resistance circuit.

Some transistor formulas are shown below.

Transistor total current:

$$I_E = I_B + I_C$$

Where :

I_E = emitter current

I_B = base current

I_C = collector current

Common emitter gain :

$$\text{Beta } (\beta) \text{ or } h_{fe} = \frac{\Delta I_C}{\Delta I_B}$$

Where :

hfe = h = hybrid

f = forward current ratio

e = common emitter configuration

Δ = delta (indicates a change)

Common base gain :

$$\text{Alpha } (\alpha) = \frac{\Delta I_C}{\Delta I_E}$$

or

When β is known:

$$\alpha = \frac{\beta}{\beta + 1}$$

Alpha is always less than 1 for a common base configuration.

Common collector gain :

$$\text{Gamma or } \gamma = \frac{I_E}{I_B}$$

When beta is known then :

$$\gamma = \beta + 1$$

TRANSISTOR RUGGEDNESS.—Transistors are generally more rugged mechanically than electron tubes. They are susceptible to damage by electrical overloads, heat, humidity, and radiation. Unless you are careful, damage can occur during maintenance.

DAMAGE PREVENTION.—To prevent damage and avoid electrical shock, use the following precautions when working on transistorized equipment:

- Check your test equipment and soldering irons for leakage current from the power source. If leakage current exists, use an isolation transformer to eliminate the current.

- Connect a ground between the test equipment and circuit under test.
- Do not exceed the maximum allowable voltages for circuit components and transistors.
- Ohmmeter ranges that require more than one milliampere should not be used for testing transistors.
- Battery eliminators should not be used to furnish power for transistorized equipment. They have poor voltage regulation.
- The heat applied to a transistor, when soldered connections are required, should be kept to a minimum by the use of low-wattage soldering irons and heat shunts or heat sinks.
- When replacing transistors, never pry them from the printed circuit board.
- Check all circuits for defects before replacing transistors.
- Remove power from the equipment prior to replacing a transistor.
- Use extreme care when using test probes on a transistorized circuit. It is easy to short across adjacent terminals with conventional probes. Try insulating the probe tips and leaving a very short section of the point exposed.

You can find more about transistors in NEETS, Module 7, *Introduction to Solid-State Devices and Power Supplies*.

Vacuum Tubes

The characteristics of a vacuum tube are measured by two factors: **AMPLIFICATION FACTOR**, μ , and **TRANSCONDUCTANCE** (gm).

Formula for amplification factor:

$$\mu = \frac{\Delta E_p}{\Delta E_g}$$

E_p = change in plate voltage

E_g = change in grid voltage

Formula for transconductance (gm) is:

$$gm = \frac{I_p}{E_g}$$

I_p = change in plate current

E_g = change in grid voltage

Information on vacuum tubes can be found in NEETS, Module 6, *Introduction to Electronic Emission, Tubes, and Power Supplies*.

CAUTION

Because vacuum tubes become hot and most are made of glass, use caution while removing or replacing them. Use vacuum tube pullers or at least wear some type of hand protection.

Wavelength

Wavelength is the distance in space occupied by one cycle of a radio wave at any given instant. If a radio wave could be frozen in time and measured, the distance from the leading edge of one cycle to the leading edge of the next cycle would be the wavelength. Wavelength varies from a few hundredths of an inch at the high frequencies to many miles at extremely low frequencies. Common practice is to express wavelength in meters. The Greek letter lambda (!) is used to signify wavelength. Formulas for wavelength, period, and velocity are shown below.

Wavelength formula:

$$\lambda = \frac{v}{f}$$

Lambda (λ) = wavelength in feet

v = velocity of propagation in feet per second

f = frequency in Hz

Frequency formula:

$$f = \frac{1}{T}$$

T = time of one wave period (cycle) in seconds

f = frequency in Hz

Period formula :

$$T = \frac{1}{f}$$

Velocity formula :

$$v = \lambda f$$

You can find more information on wavelength, frequency, period, and velocity in NEETS, Module 10, *Introduction to Wave Propagation, Transmission Lines, and Antennas*.

Radar

Some helpful radar information/formulas are shown below.

PW Pulse Width—The width of the transmitted RF pulse from the radar (the term can also be used regarding other non-RF information).

$$PW = DC \times PRT$$

PRT Pulse Repetition Time—The duration of the time between radar transmitter pulses (leading edge of pulse to leading edge of the next pulse).

$$PRT = \frac{1}{PRF}$$

PRR or PRF PRF Pulse Repetition Rate or Pulse Repetition Frequency—the number of pulses that occur during one second.

$$PRF = \frac{1}{PRT}$$

DC Duty Cycle—The amount of actual transmitter pulse time (PW) divided by the amount of transmitter total time (PRT). For radar applications, the duty cycle will always be less than one.

$$DC = \frac{PW}{PRT} \text{ or } \frac{P_{avg}}{P_{pk}}$$

P_{pk} Power Peak (normally referenced in kilowatts)—The actual power of the transmitted RF pulse (PW).

$$P_{pk} = \frac{P_{avg}}{DC}$$

P_{avg} Average Power (normally referenced in watts)—The transmitted power relative to one PRT.

$$P_{avg} = DC \times P_{pk}$$

$$\text{Nautical radar mile} = \frac{\text{elapsed time}}{12.36 \text{ microseconds}}$$

Minimum radar range = (pulse width + *recovery time) × 164 yards

*In most modern radar systems, recovery time is negligible and does not need to be considered when figuring minimum radar range.

$$\text{Radar horizon distance (nautical miles)} = 1.25 \sqrt{\text{antenna height (ft)}}$$

Radar range resolution (in yards) = pulse width × 164 yards per microsecond.

When you use the term decibel (dB), you are referring to a logarithmic comparison between two signals, usually the output and the input. In power measurement applications, however, a reference of 0 dBm equalling 1 milliwatt is usually used. The term dBm is used to represent power levels above, below, or at 1 milliwatt.

The following formulas are used for figuring dB:

As a power ratio :

$$\text{dB} = 10 \log_{10} \frac{P_2}{P_1}$$

As a voltage ratio :

$$\text{dB} = 20 \log_{10} \frac{E_2}{E_1}$$

As a current ratio :

$$\text{dB} = 20 \log_{10} \frac{I_2}{I_1}$$

In circuits where impedances may vary:

$$\text{Voltage dB} = 20 \log_{10} \frac{E_2 R_1}{E_1 R_2}$$

$$\text{Current dB} = 20 \log_{10} \frac{I_2 R_2}{I_1 R_1}$$

Some basic information to remember:

Power

A gain of 1 dB power is equal to $1.25 \times$ that power

A gain of 3 dB power is equal to $2.00 \times$ that power

A gain of 10 dB power is equal to $10.0 \times$ that power

A gain of 1 dB power is equal to $0.80 \times$ that power

A loss of 3 dB power is equal to $0.50 \times$ that power

A loss of 10 dB power is equal to $0.10 \times$ that power

Voltage

A gain of 1 dB is equal to $1.118 \times$ that voltage

A gain of 6 dB is equal to $2.000 \times$ that voltage

A gain of 20 dB is equal to $10.00 \times$ that voltage

A loss of 1 dB is equal to $0.894 \times$ that voltage

A loss of 6 dB is equal to $0.500 \times$ that voltage

A loss of 20 dB is equal to $0.100 \times$ that voltage

POWER CONVERSION

For ease of power conversion, this listing provides rough, basic data:

Log or dB	Gain or mw
11	12.5
10	10
9	8
8	6.25
7	5
6	4
5	3.125
4	2.5
3	2
2	1.6
1	1.25
0	1
-1	0.8
-2	0.625
-3	0.5
-4	0.4
-5	0.312
-6	0.25
-7	0.2
-8	0.16
-9	0.125
-10	0.1
-11	0.08

The figures in the above listing are not precise, but are accurate for most applications. For figures in between the above numbers, logarithm interpolation must be done. Table 1-34 provides a seven-place table of common logarithms.

The following are examples of power conversion:

Example 1:

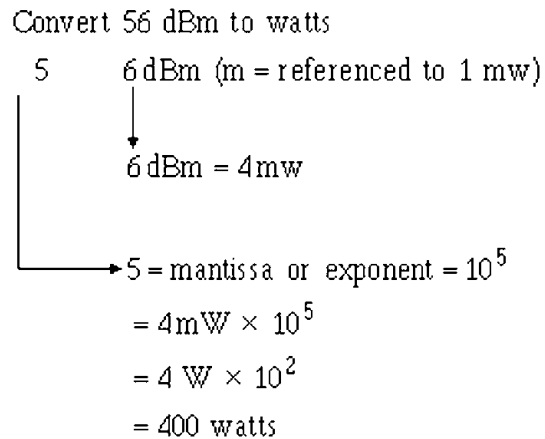

Example 2:

Convert -52 dBm to μw (microwatts)

$$\begin{array}{l}
 -5 \quad 2 \text{ dBm} \\
 \downarrow \\
 -2 \text{ dBm} = .625 \text{ mw} \\
 \rightarrow -5 = \text{mantissa or exponent} = 10^{-5} \\
 = .625 \text{ mw } 10^{-5} \\
 = .625 \mu w \times 10^{-2} \\
 = .00625 \mu w
 \end{array}$$

Example 3:

Convert 80 kw to dBm

$$= \frac{8 \times 10^7 \text{ mw}}{79 \text{ dbm}} \quad 8 \text{ mw} = 9 \text{ dB}$$

Convert 5 μw to dBm

$$= \frac{5 \times 10^{-3} \text{ mw}}{-37 \text{ dBm}} \quad 5 \text{ mw} = 7 \text{ dBm}$$

DATA TABLES

Data tables are provided for reference. Information in the tables are the usually accepted standards. Various military standards have also been used to provide these tables.

Capacitor Identification

Two methods of capacitor identification are used. The first is the typographical method, and the second is the color code method. Typographically marked identification will be discussed first. It is the type marking where a number is printed on the capacitor. You should note that on different physical styles of capacitors, the printed number may be in either microfarads or picofarads. Two styles of capacitors have been selected from Military Standard 198E (MIL-STD-198E) to show how the part number stamped on the capacitor is broken down.

Table 1-1 shows the CB style of capacitor part number breakdown.

Table 1-1.—CB Style Capacitor Part Number Breakdown

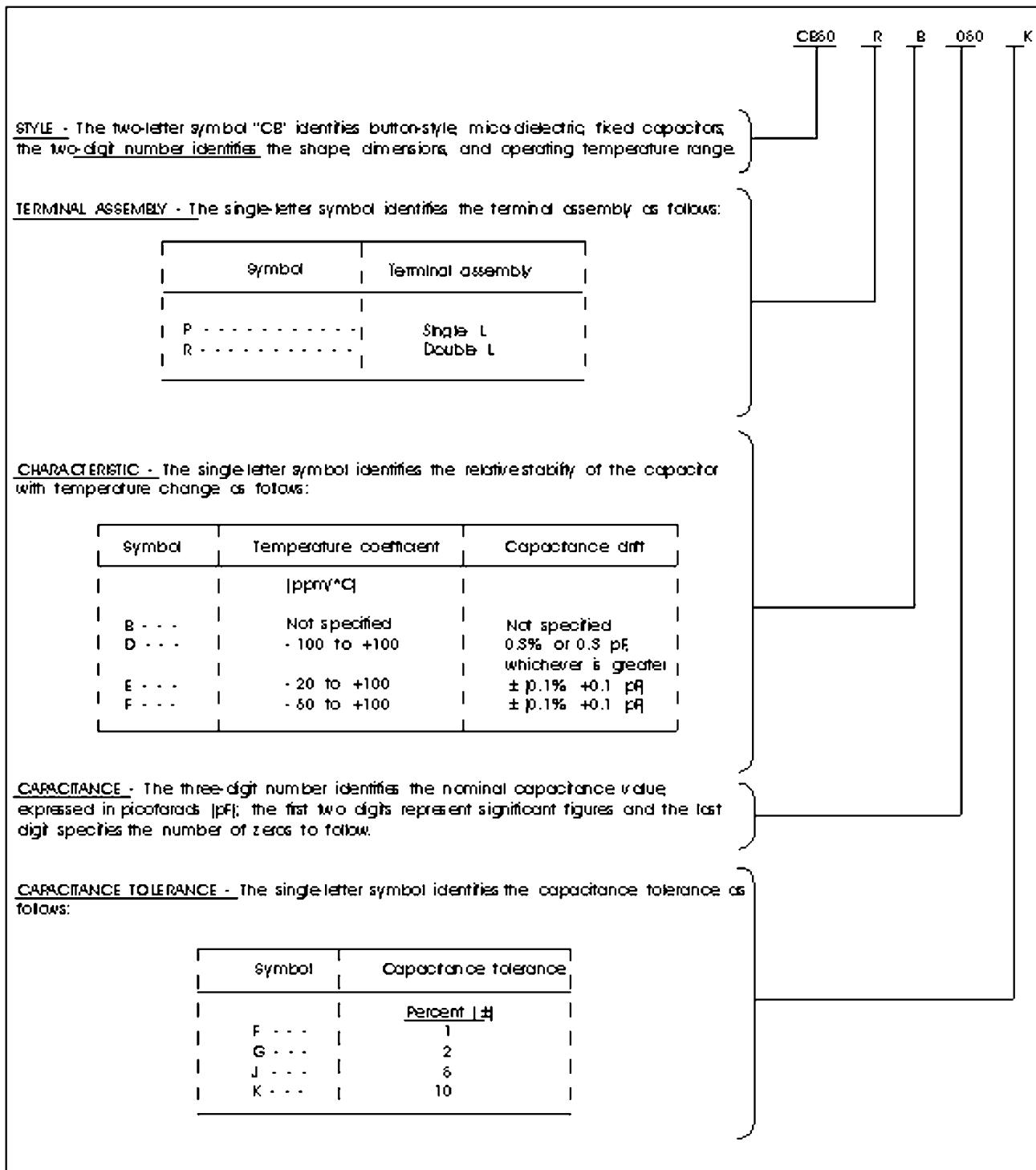

Table 1-2 shows how the part number on the CMR style of capacitor is broken down

Table 1-2.—CMR Style Capacitor Part Number Breakdown

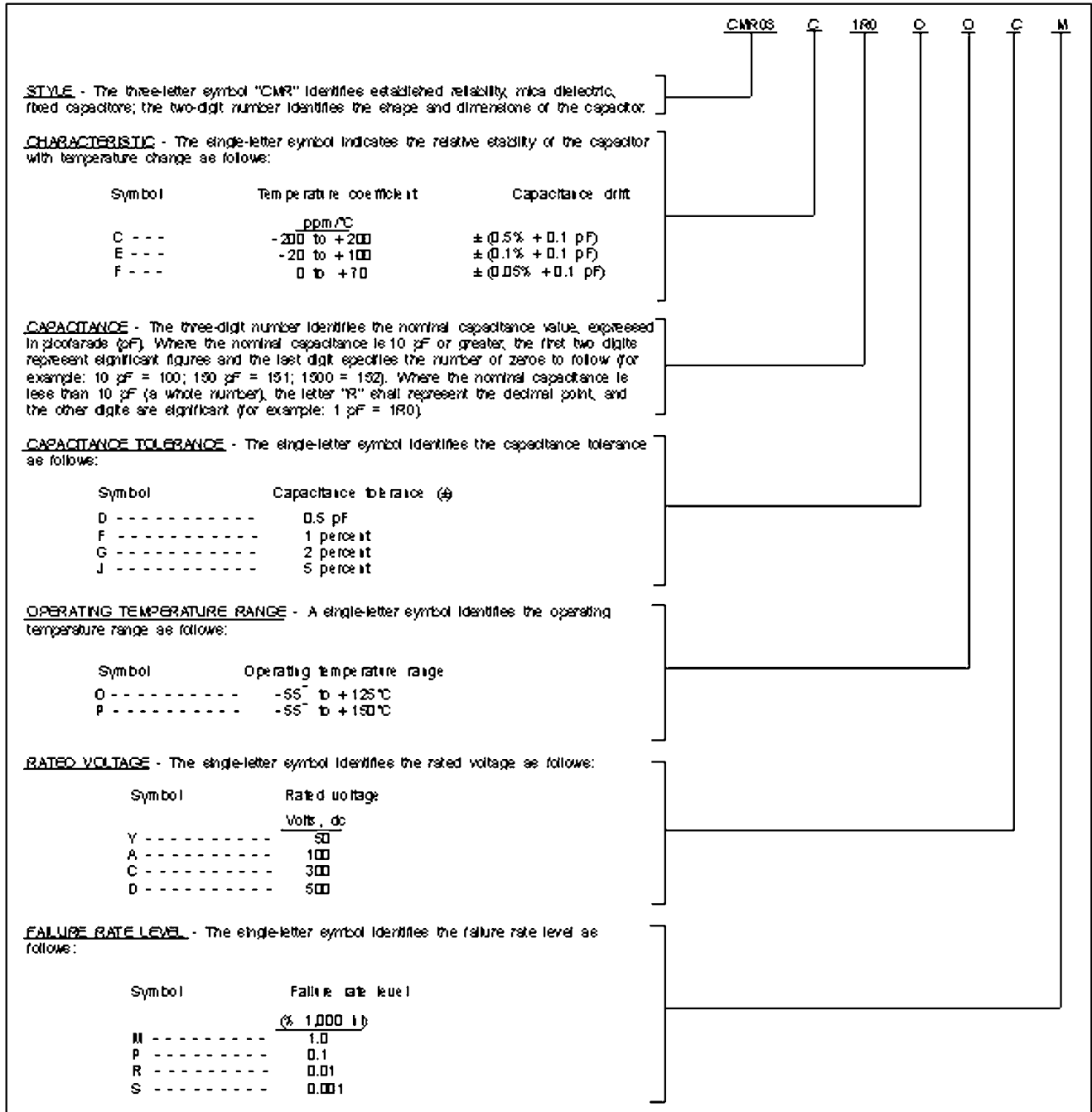

Table 1-3 is a partial cross reference list of the CYR10 (MIL-C-23269/1) style of capacitor. As an example, if you need a 3.3 pF, 500 VDC capacitor in the CYR10 style, with a failure rate (FR) of 1 percent per 1,000 hours, the part number would be M23269/01-3009.

Table 1-3.—CYR10 Style Capacitor Cross-Reference

STYLE CYR10 (MIL-C-23289/1)

**OPERATING TEMPERATURE RANGE -55° TO +125°C -- TEMPERATURE COEFFICIENT
140 ± 25 PPM/°C -- CAPACITANCE DRIFT 0.1% OR 0.1 pF, WHICHEVER IS GREATER**

Capacitance value	DC rated voltage	Capacitance tolerance	Dash number M23289/01			
			FR level in %/1,000 hours			
			M (1.0)	P (0.1)	R (0.01)	S (0.001)
pF	volts, dc					
0.5	500	±0.25 pF	3001	4001	5001	6001
1.0	↑	±0.25 pF	3002	4002	5002	6002
1.5		±0.25 pF	3003	4003	5003	6003
2.2		±0.25 pF	3004	4004	5004	6004
2.7		±0.25 pF	3006	4006	5006	6006
3.3		±0.25 pF	3005	4009	5009	6009
3.9		±0.25 pF	3010	4010	5010	6010
3.9	↓	±0.25 pF	3012	4012	5012	6012
4.7		±0.25 pF	3015	4015	5015	6015
5.5		±0.25 pF	3017	4017	5017	6017
5.5		±5%	3018	4018	5018	6018
6.8		±0.25 pF	3021	4021	5021	6021
6.8		±5%	3022	4022	5022	6022
8.2		±0.25 pF	3025	4025	5025	6025
8.2		±5%	3026	4026	5026	6026

Table 1-3 is not a complete list of the CYR10 style capacitor. The CYR10 is not the only style capacitor listed this way. You should refer to Military Standard 198E (MIL-STD-198E), *Capacitors, Selection and Use of*, for more information.

The color coding identification method is becoming obsolete. This method is included for the technician who is required to work on some older model equipment.

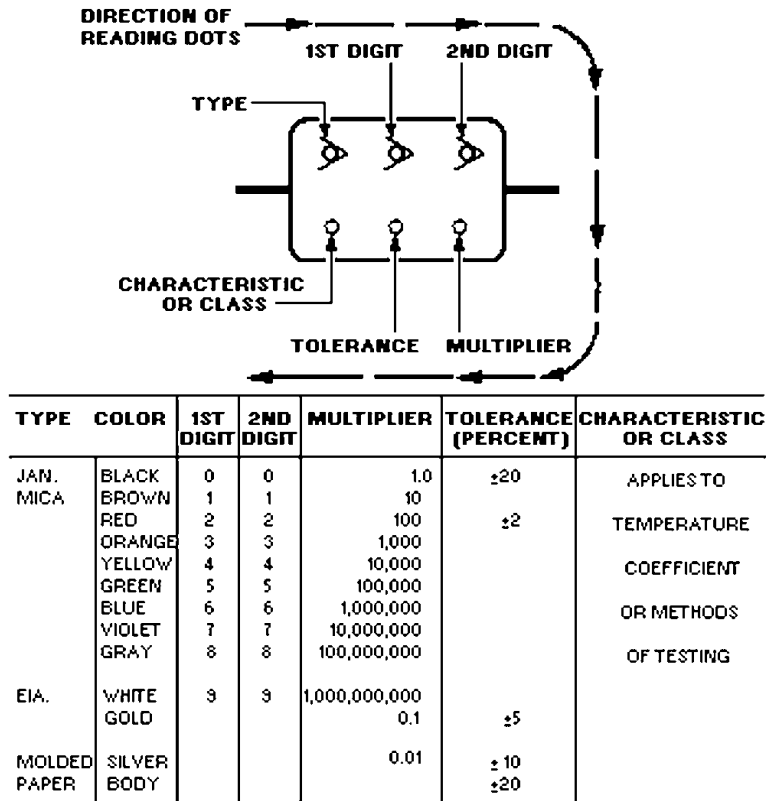

Figure 1-14.—Six-dot color code for mica and molded paper capacitors.

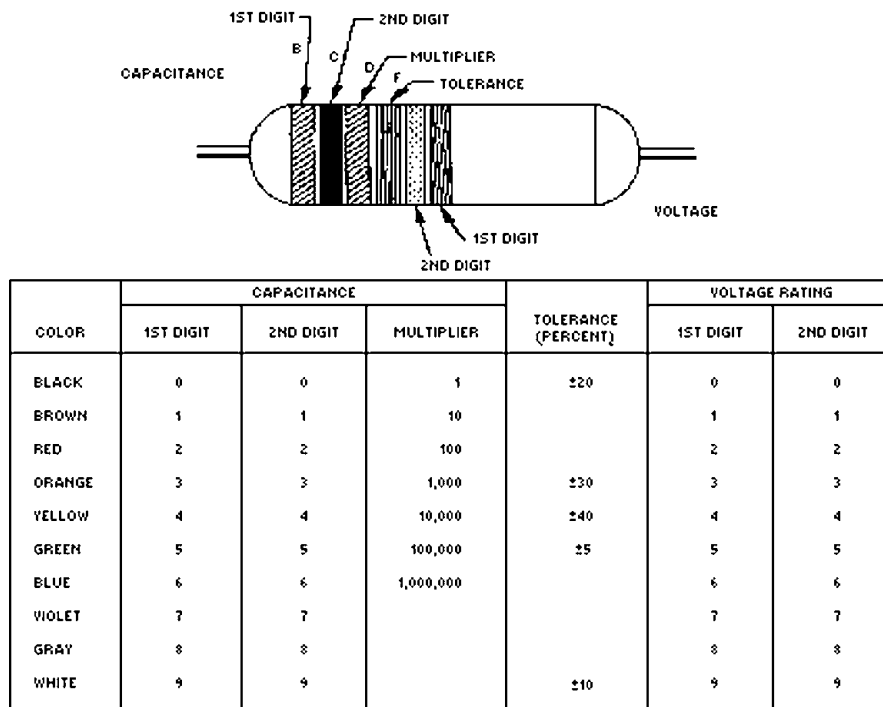
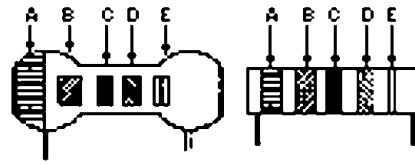
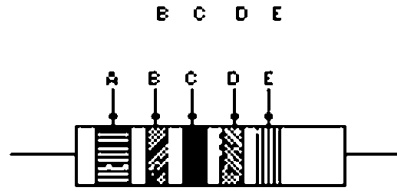

Figure 1-15.—Six-band color code for tubular paper dielectric capacitors.

B - A - TEMPERATURE COEFFICIENT
 B - 1ST DIGIT
 C - 2ND DIGIT
 D - MULTIPLIER
 E - TOLERANCE



RADIAL LEAD CERAMICS



AXIAL LEAD CERAMIC

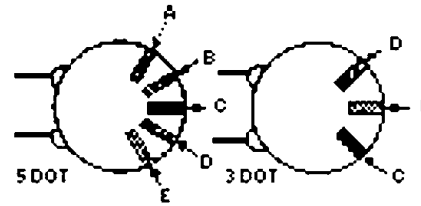

CERAMIC DISC CAPACITOR MARKING

COLOR	1ST DIGIT	2ND DIGIT	MULTIPLIER	TOLERANCE		TEMPERATURE COEFFICIENT
				MORE THAN 10 pF (IN PERCENT)	LESS THAN 10 pF (IN pF)	
BLACK	0	0	1.0	± 20	± 2.0	0
BROWN	1	1	10	± 1		-30
RED	2	2	100	± 2		-80
ORANGE	3	3	1,000			-150
YELLOW	4	4	10,000			-220
GREEN	5	5		± 5	± 0.5	-330
BLUE	6	6				-470
VIOLET	7	7				-750
GRAY	8	8	.01		± 0.25	+30
WHITE	9	9	.1	± 10	± 1.0	+120 TO -750 (EIA) +500 TO -330 (JAN) +100 (JAN)
SILVER						BYPASS OR COUPLING (EIA)
GOLD						

Figure 1-16.—Ceramic capacitor color code.

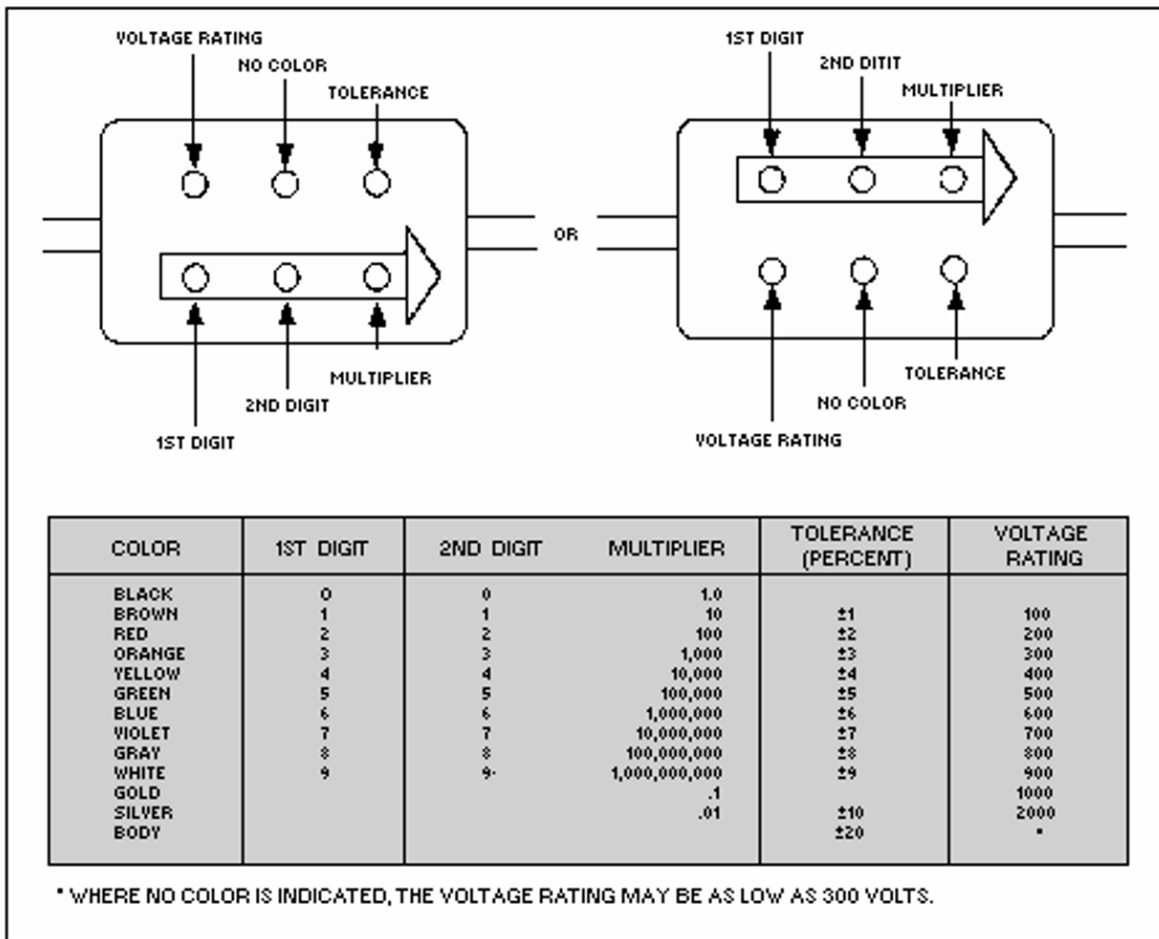

Figure 1-17.—Mica capacitor color code.

Table 1-4 shows some principal capacitor applications by type and military specification.

Table 1-4.—Principal Applications of Capacitors

MILITARY SPECIFICATION	Establishing Reliability	Capacitor Type	APPLICATION											
			Blocking	Buffering	By-passing	Coupling	Filtering	Tuning	Temperature compensating	Trimming	Motor starting	Timing	Noise suppression	
MIL-C-5		Mica	x	x	x	x	x	x	x				x	
MIL-C-20	x	Ceramic			x	x	x	x	x		x			
MIL-C-62		Aluminum			x			x						
MIL-C-81		Ceramic Trimmer		x		x			x					
MIL-C-10950		Mica			x	x			x		x			
MIL-C-11015		Ceramic	x			x	x							
MIL-C-14409		Piston Trimmer							x		x			
MIL-C-19978	x	Plastic	x	x	x	x	x							
MIL-C-23183		Vacuum	x		x	x	x	x						
MIL-C-23269	x	Glass	x		x	x	x		x					
MIL-C-39001	x	Mica	x	x	x	x	x	x						
MIL-C-39003	x	Solid Tantalum	x		x	x	x	x				x	x	x
MIL-C-39006	x	Wet Tantalum	x		x	x	x	x						
MIL-C-39014	x	Ceramic			x	x	x	x						
MIL-C-39018	x	Aluminum	x		x	x	x	x						
MIL-C-39022	x	Met. Plastic	x		x	x	x	x						
MIL-C-55365	x	Solid Tantalum, Chip			x		x	x						
MIL-C-55514	x	Plastic	x			x								
MIL-C-55681	x	Ceramic, Chip			x	x	x	x				x		
MIL-C-83421	x	Met. Plastic	x	x	x	x	x	x						

Table 1-5 is a capacitor style to military specification cross referencing. This cross reference guide is included for general information only; some styles are not preferred standards and, therefore, are not included in this standard.

Table 1-5.—Style to Military Specification Cross-Reference

STYLE	SPECIFICATION	DESCRIPTION	CLASS	STATUS	REPLACEMENT
CA	MIL-C 12889	Paper, By-Pass	Non-ER	I	19978
CB	10950	Mica, Button, Feed-Thru	Non-ER	A	
CC	20	Ceramic, Encap., Temp. Comp.	Non-ER	PI	CCR
CCR	20	Ceramic, Encap., Temp. Comp.	ER	A	
CDR	55681	Ceramic, Chip	ER	A	
CE	62	Aluminum Electrolytic	Non-ER	PI	39018
CFR	55514	Plastic, Non-Herm. Sealed	ER	A	
CG	23183	Vacuum or Gas, Variable	Non-ER	A	
CH	18312	Metallized Paper, or Plastic	Non-ER	I	39022
CHR	39022	Metallized Plastic, Herm. Sealed	ER	A	
CJ	3871	Aluminum, Motor Start	Non-ER	C	EIA RS-463 39014
CK	11015	Ceramic, Encapsulated	Non-ER	PI	
CKR	39014	Ceramic, Encapsulated	ER	A	
CKS	123	Ceramic, Encapsulated and Chip	Hi-Rel	A	
CL	3965	Tantalum, Foil and Wet Slug	Non-ER	I	39006
CLR	39006	Tantalum, Foil and Wet Slug	ER	A	
CM	5	Mica, Molded, Silvered, and RF	Non-ER	PI	39001

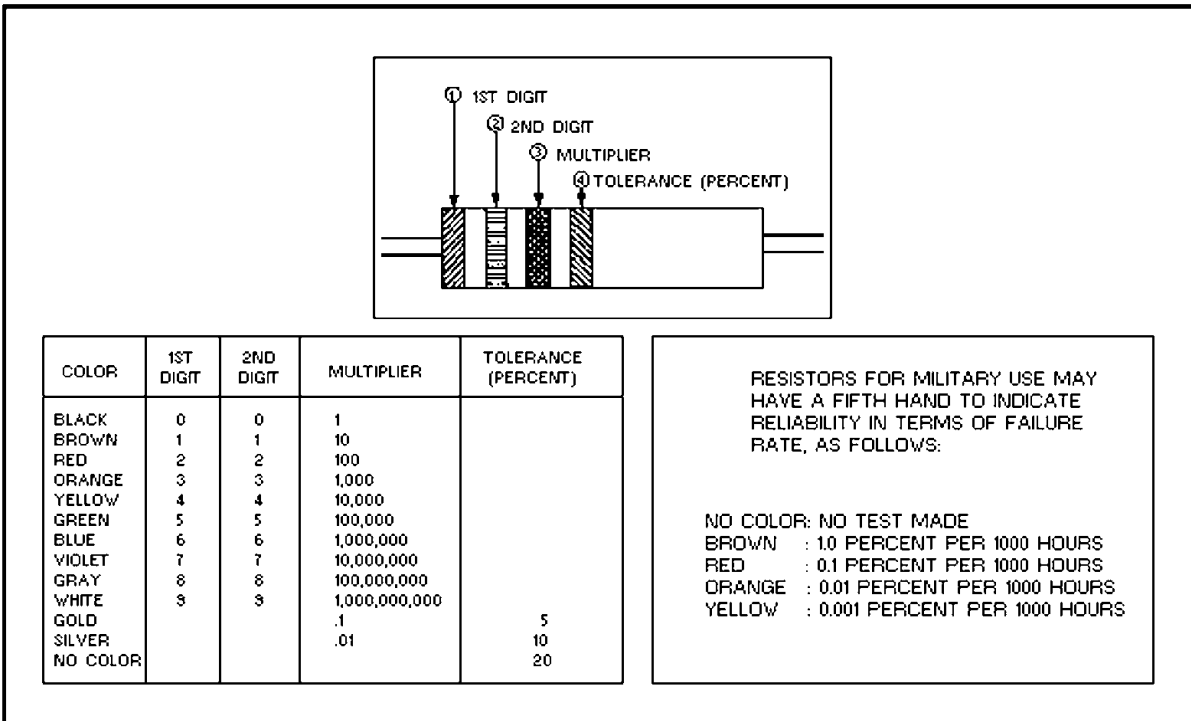

Figure 1-18.—Resistor color code.

Table 1-6 is a resistor selection chart. As an example, let's suppose you need a 1-watt, composition resistor. Look under the "type" heading to find composition. Then look under the "power and max voltage ratings" headings to find 1W/500V. The style you select should be RCR32. This is the first part of the part number. To find the last part of the desired part number, the ohmic value, refer to table 1-7, the resistor type designation part number breakdown.

Tables 1-6 and 1-7 are excerpts from Military Standard 199C(MIL-STD-199C) and are included as examples of the information contained in MIL-STD-199C. If another type of resistor is needed, the complete part number breakdown can be located in MIL-STD-199C.

Table 1-6.—Resistor Selection Chart

Military specification	Type	Styles available in standard	Power and max voltage ratings	Resistance tolerance (+ percent)	Ohmic range				
MIL-R-26	Wirewound (Power Type)	RW29	11W	5, 10 ↓	.1 to 5.6 K				
		RW31	14W		.1 to 6.8 K				
		RW33	26W		.1 to 18 K				
		RW35	55W		.1 to 43 K				
		RW37	113W		.1 to 91 K				
		RW38	159V		.1 to 15 M				
		RW47	210W		.1 to 18 M				
		RW56	14W		.1 to 9.1 K				
MIL-R-22684	Film (Insulated)	RL42. . .TX	2W/500V	2, 5	10 to 1.5 M				
MIL-R-18546	Wirewound (Power Type, Chassis Mounted)	RE77	75W	1	.05 to 29.4 K				
		RE80	120W	1	.1 to 35.7 K				
MIL-R-39008	Composition (Insulated), Established Reliability	RCR05	.125W/150V	5, 10 ↓	2.7 to 22 M				
		RCR07	.25W/250V		2.7 to 22 M				
		RCR20	.5W/350V		1.0 to 22 M				
		RCR32	1W/500V		1.0 to 22 M				
		RCR42	2W/500V		10 to 22 M				
MIL-R-55182	Film, Established Reliability	RNR50	.05W/200V	.1, .5, 1 ↓	10 to 796 M				
			.1W/200V		10 to 2.0 M				
		RNR55	.1W/200V		.1, .5, 1 ↓	10 to 2.0 M			
			.125/200V			1.0 to 4.02 M			
		RNR60	.125W/250V			.1, .5, 1 ↓	1.0 to 4.02 M		
			.25W/300V				1.0 to 8.06 M		
		RNR65	.25W/300V				.1, .5, 1 ↓	1.0 to 8.06 M	
			.5W/350V					1.0 to 15 M	
		RNR70	.5W/350V					.1, .5, 1 ↓	1.0 to 15 M
			.75W/500V						24.9 to 2 M
RNR75	1W/750V	.1, .5, 1 ↓	24.9 to 2 M						
	2W/750V		.05, .01, .005						
RNC90	.3W/300V			.05, .01, .005	4.99 to 100K				
.	6W/300V								

1/ M = megohms; K = kilohms.

Table 1-6.—Resistor Selection Chart—Continued

Military specification	Type	Styles available in standard	Power and max voltage ratings	Resistance tolerance (+ percent)	Ohmic range
MIL-R-39005	Wirewound (Accurate), Established Reliability	RBR52	.5W/600V	↓ .01, .05, .1, 1	.1 to .806 M
		RBR53	.33W/300V		.1 to .499 M
		RBR54	.25W/300V		.1 to .255 M
		RBR55	.15W/200V		.1 to .150 M
		RBR56	.125W/150V		.1 to .1 M
		RBR57	.75W/600V		.1 to 1.37 M
		RBR71	.125W/150V		.1 to .1 M
		RRBR75	.125W/150V		.1 to 71.5 K
MIL-R-39007	Wirewound (Power Type), Established Reliability	RWR78	10W	↓ .1, .5, 1	.1 to 39.2 K
		RWR80	2W		.1 to 1.21 K
		RWR81	1W		.1 to .464 K
		RWRB2	1.5W		.1 to .931 K
		RWR84	7W		.1 to 12.4 K
		RWR89	3W		.1 to 3.57 K
MIL-R-39017	Film (Insulated), Established Reliability	RLR05	.125W/200V	↓ 1, 2	4.7 to .3 M
		RLR07	.25W/250V		10 to 2.49 M
		RLR20	.5W/350V		4.3 to 3.01 M
		RLR32	1W/500V		10 to 1.0 M
MIL-R-39009	Wirewound (Power Type, Chassis Mounted), Established Reliability	RER40	5W	↓ 1	1 to 1.65 K
		RER45	10W		1 to 2.80 K
		RER50	20W		1 to 6.04 K
		RER55	30W		1 to 19.6 K
		RER60	5W		.1 to 3.32 K
		RER65	10W		.1 to 5.62 K
		RER70	20W		.1 to 12.1K
		RER75	30W		.1 to 39.2 K
MIL-R-55342	Film, Chip, Established Reliability	RM0502	.02W/40V	↓ 1, 5, 10	5.6 to .1 M
		RM0505	.15W/40V		5.6 to .47 M
		RM0705	.10W/40V		5.6 to .1 M
		RM1005	.15W/40V		5.6 to .47 M
		RM1505	.10W/50V		5.6 to .1 M
		RM2208	.225W/50V		5.6 to 15 M

1/ M = megohms; K = kilohms.

Table 1-7.—Resistor Type Designation Part Number Breakdown

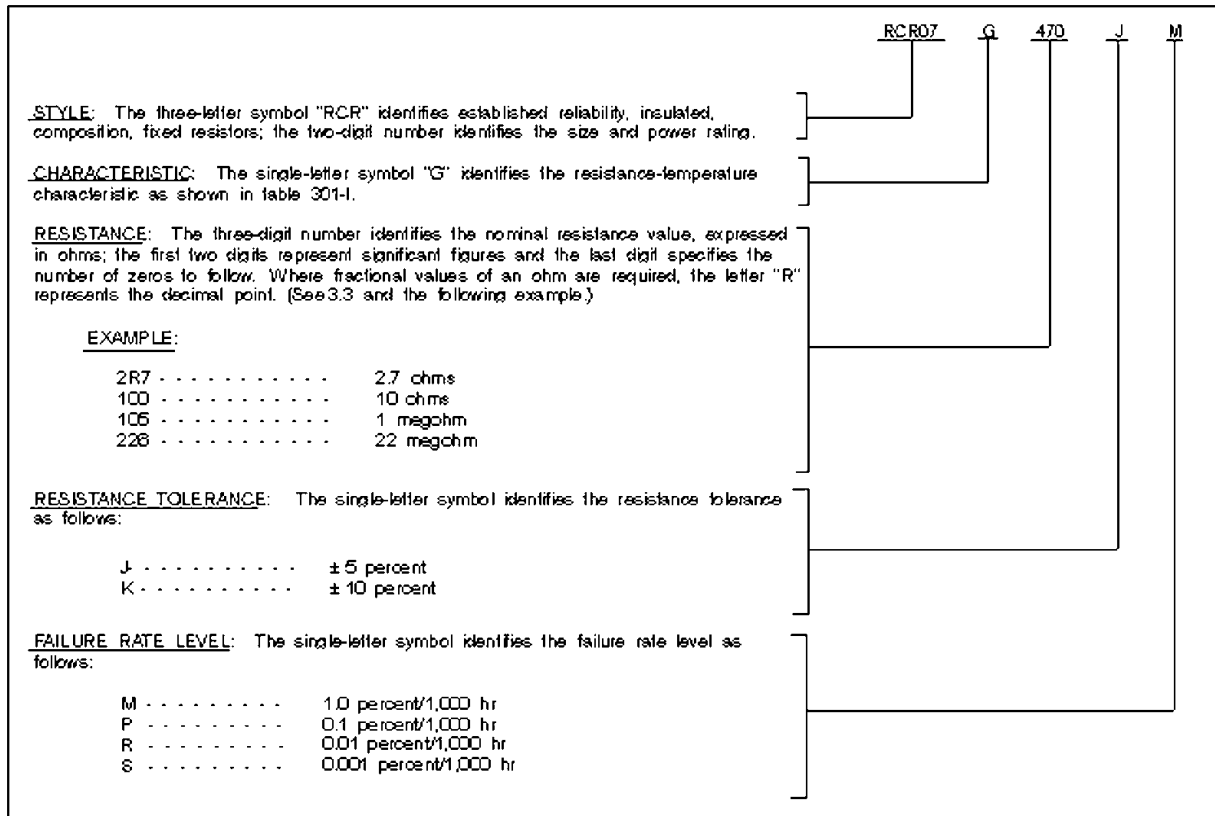

Transformer Lead Identification

This area contains color coding identification as it relates to transformers.

Figure 1-19 shows the color codes for power transformers, IF transformers, and interstage-audio transformers.

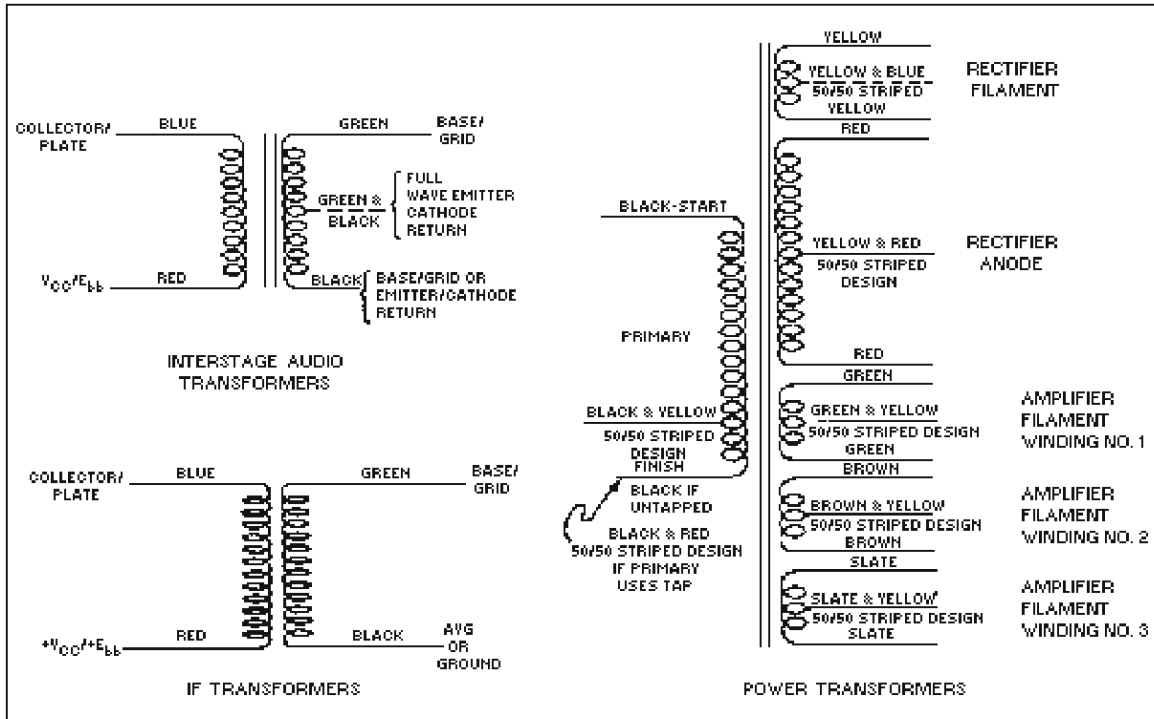

Figure 1-19.—Color code for transformers.

Chassis Wiring Identification

The standard colors used in chassis wiring for the purpose of equipment circuit identification follow:

CIRCUIT	COLOR
GROUNDS, GROUNDED ELEMENTS, AND RETURNS	BLACK
BEATERS OR FILAMENTS, OFF GROUND	BROWN
POWER SUPPLY $+V_{cc}/+E_{bb}$	RED
SCREEN GRIDS	ORANGE
EMITTERS/CATHODES	YELLOW
BASES/CONTROL GRIDS	GREEN
COLLECTORS/PLATES	BLUE
POWER SUPPLY, $-V_{cc}/-E_{bb}$	VIOLET (PURPLE)
AC POWER LINES	GRAY
MISCELLANEOUS, ABOVE OR BELOW GROUND RETURNS, AUTOMATIC VOLUME CONTROL (AVC)	WHITE

Semiconductor Case Outlines, Color Coding, Lead Identification, and Pin Placement

Case outlines, color coding, lead identification, and pin placements of common semiconductor devices are used frequently by the technician and are included in figures 1-20, 1-21, and 1-22.

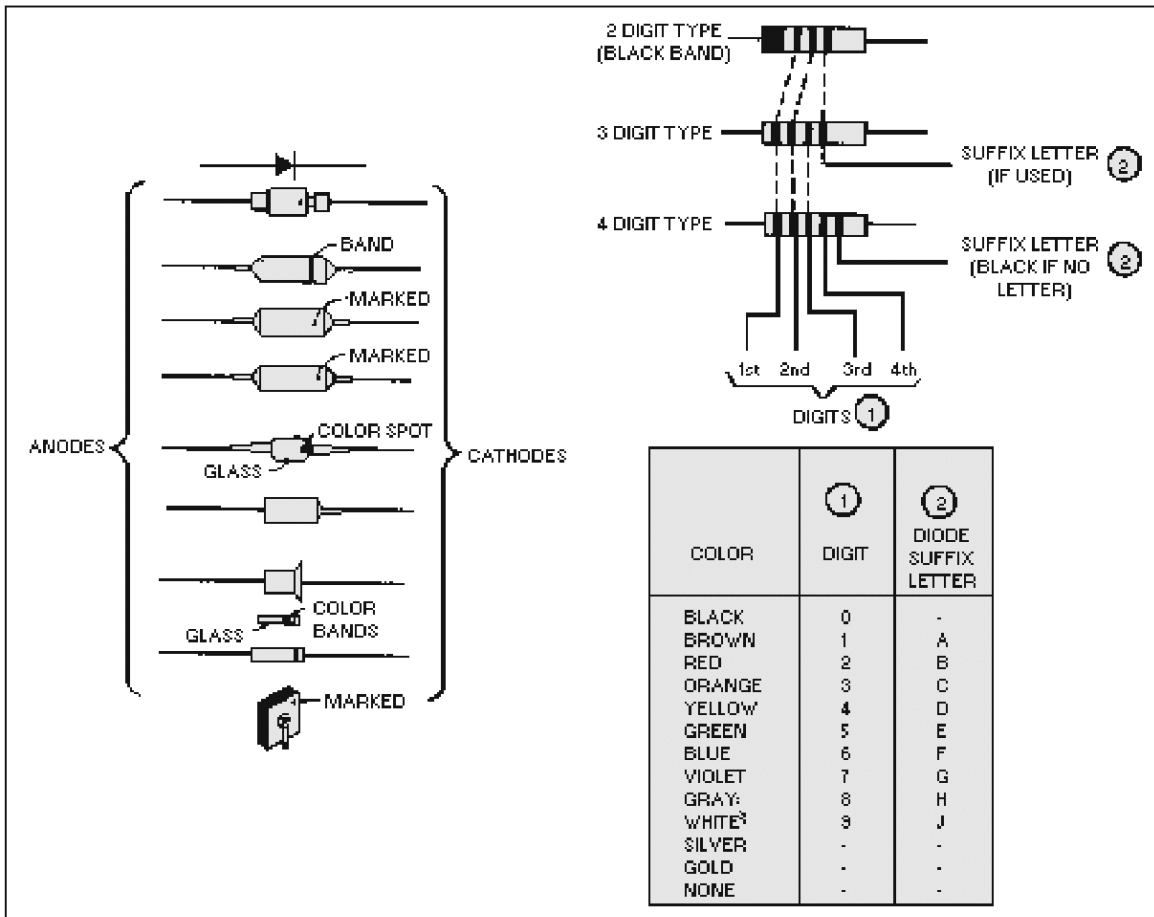

Figure 1-20.—Semiconductor diode markings and color code system.

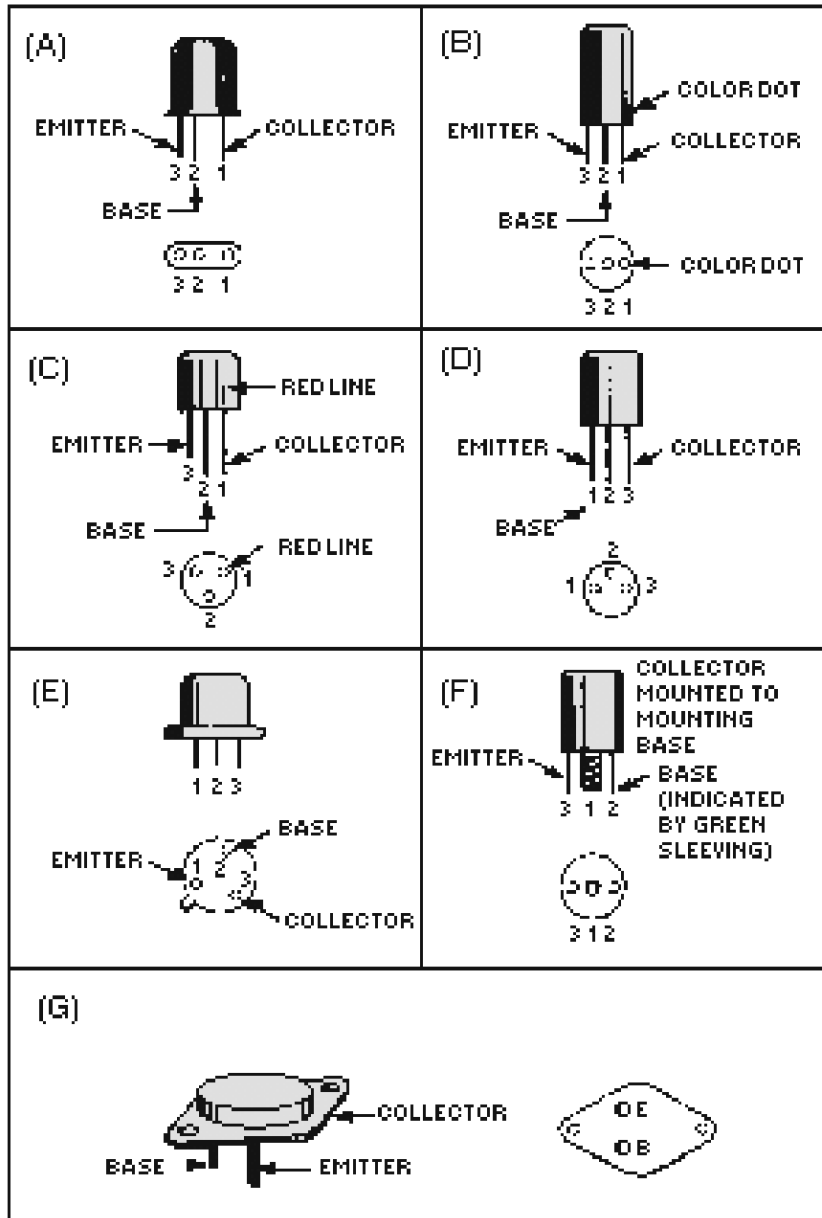

Figure 1-21.—Transistor lead identification and case outline.

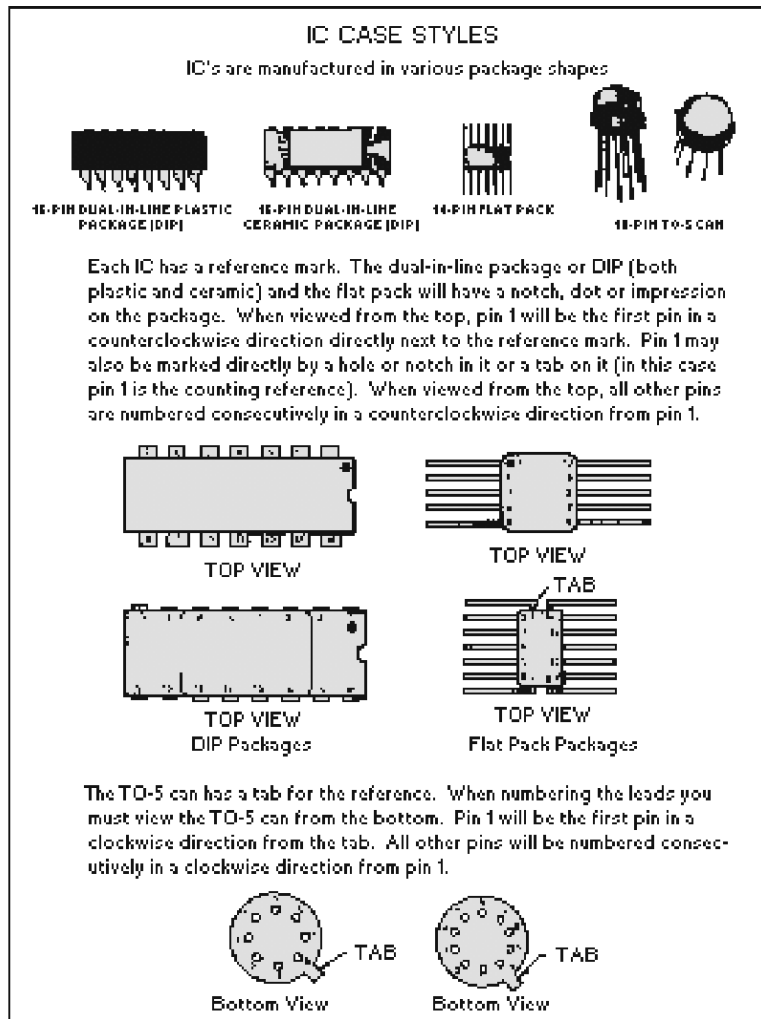

Figure 1-22.—IC identification and pin placement.

Batteries

The two fundamental types of batteries are the **PRIMARY CELL** and **SECONDARY CELL**. Primary cells are those commonly used in flashlights and some portable, hand-held test equipment. Common sizes and part numbers are:

SIZE	PART NUMBER
AA	BA58
C	BA42
D	BA30

Secondary cell batteries are the type used in automobiles. They are rechargeable.

Safety precautions concerning charging, handling, and storage of batteries can be found in the Electronics Installation and Maintenance Book (EIMB), *General*, NAVSEA SE000-00-EIM-100. Stock

numbers and part numbers can be found in NAVSUP Publication 4400, the *Afloat Shopping Guide*. The federal supply classification (FSC) number for batteries is 6135. You can also find more information on batteries in NEETS, Module 1, *Introduction to Matter, Energy, and Direct Current*.

Cables

Tables 1-8 and 1-9 contain type, construction, and application data on shipboard cable. These tables contain current, discontinued, and some recently obsolete types of cables and cords.

Table 1-8.—Types and Construction/Description of Shipboard Cable

CVSF	400-Hz aircraft servicing: three synthetic rubber insulated conductors and one uninsulated conductor, overall polychloroprene jacket.
DLT	Divers lifeline and telephone: four rubber insulated conductors cabled around an insulated steel core, reinforced polychloroprene jacket overall.
DSS	Double conductor, shielded: rubber insulation, overall braided shield, polychloroprene or chlorosulfonated polyethylene jacket.
DSWS	Double conductor, shielded: rubber insulation, overall braided shield, polychloroprene jacket.
FSS	Four conductors, shielded: rubber insulated, overall braided shield, polychloroprene or chlorosulfonated polyethylene jacket.
JAS	Jet aircraft servicing: four rubber insulated conductors, two conductors Navy size 250, two conductors Navy size 6, reinforced polychloroprene jacket.
MCSF-4	Multiple conductor, acoustic minesweeping, power: two American Wire Gauge (AWG) 6 and two AWG 1 conductors, rubber insulation, reinforced polychloroprene jacket.
MSP	Multiple conductor: fifty-nine conductors, sixteen AWG 22 having fluorocarbon insulation and a braided copper shield, eighteen AWG 20 having polyvinyl chloride insulation and a braided copper shield (nine singles, one triad and three pairs, each shielded), twenty-five Navy size 3 having polyvinyl insulation (eight pairs and three triads, each shielded), polychloroprene jacket.
MSPW	Multiple conductor: fifty-nine conductors; sixteen AWG 22 having fluorocarbon insulation and a braided copper shield, eighteen AWG 20 having polyvinyl chloride insulation and a braided copper shield (nine singles, one triad and three pairs, each shielded), twenty-five Navy size 3 having polyvinyl insulation (eight pairs and three triads, each shielded), polychloroprene jacket, watertight.
MWF	Multiple conductor: rubber or cross-linked polyethylene insulation, arctic type neoprene jacket.
S2S	Two conductors, shielded: cross-linked polyethylene insulations, braided shield, rubber insulation over shield, outer-braided shield; reinforced rubber, insulated, arctic type polychloroprene jacket.
THOF	Three conductors, heat and oil resistant, flexible: synthetic rubber insulation standard thermoplastic jacket on THOF-42, and polychloroprene jacket on THOF-400 and THOF-500.
TRF	Single conductor, flexible: rubber insulation, polychloroprene jacket.
TPUM-6	Telephone, portable, multiple conductor: copper-clad steel conductors, polypropylene insulation, six pairs cabled, polyurethane jacket applied in two layers.
TRXF	Single conductor: polychloroprene jacket.
TSP	Twisted pairs: polyvinyl chloride insulated, special thermoplastic jacket, watertight, unarmored.
TSPA	Twisted pairs: polyvinyl chloride insulated, special thermoplastic jacket, watertight, armored.

Table 1-8.—Types and Construction/Description of Shipboard Cable—Continued

TSS	Three conductors, special purpose, shielded: rubber insulation, overall braided shield, polychloroprene or chlorosulfonated polyethylene jacket.
1SWF	Singles, shielded: polyethylene insulation, braided shield on each conductor, arctic type polychloroprene jacket.
2SWF	Pairs, shielded, watertight, flexible: polyethylene insulation, braided shield over each pair, arctic type polychloroprene jacket.
5SS	Five conductors, shielded, sonar: rubber insulation, braided shield on one conductor only, and a braided shield over the assembled five conductors, polychloroprene jacket overall.
7SS	Seven conductors, shielded: rubber insulation, overall braided shield, polychloroprene or chlorosulfonated polyethylene jacket.

Table 1-9.—Shipboard Cable Application Data

Application	Cable type 2	
	Non-flexing service	Repeated flexing service
Outboard submersible: For hydrophones, transducers, outboard dial telephones, retractable antennae and similar equipment. Types MWF, 1SWF, and 2SWF are for hydrophones, transducers, and telephone lines in the weather. Types 1PR-A20E, 1PR-16, 7PR-16, 3PR-16, 1Q-16, ITR-16, and 7SPR-16S are only for submarine outboard use.	MSPW TSPA 1PR-A20E 1PR-16 7PR-16 2SPR-16 3PR-16 1Q-16 ITR-16 7SPR-16S	MSP, TSP, 5S5, S2S, DSS, FSS, TSS, MWF, DSWS, MCSF, 1SWF, 2SWF, TPUM
Welding electrode circuit		TRF TRXF
Shore-to-ship power		THOF-400 THOF-500
Diver's line and telephone		DLT
400-Hz aircraft servicing		CVSF-4
DC aircraft servicing		JAS-250
1/ The order of listing of cables for general application data has no significant meaning for their usage. 2/ Many cables are manufactured in variations of armored, unarmored, and unarmored with overall shielding.		

Table 1-10 provides data on the allowable temperature ratings and current-carrying capacities (in amperes) of some single copper conductors in free air at a maximum ambient temperature of 86° F (30° C). With temperatures greater than 86° F, the current-carrying capacity would be less.

Table 1-10.—Current-Carrying Capacities (in Amperes) of Some Single Copper Conductors at 30° C

Size	Moisture Resistant Rubber or Thermoplastic	Varnished Cambric or Heat Resistant Thermoplastic	Silicone Rubber or Fluorinated Ethylene Propylene (FEP)	Polytetra-Fluoroethylene (Teflon)
0000	300	385	510	850
000	260	330	430	725
00	225	285	370	605
0	195	245	325	545
1	165	210	280	450
2	140	180	240	390
3	120	155	210	335
4	105	135	180	285
6	80	100	135	210
8	55	70	100	115
10	40	55	75	110
12	25	40	55	80
14	20	30	45	60

More information about electrical cable used aboard ship can be found in NEETS, Module 4, *Introduction to Electrical Conductors, Wiring Techniques, and Schematic Reading; Cable Comparison Guide*, NAVSEA 0981-052-8090; and *Design Data Book*, NAVSEA 0902-LP-006-0000, Section DDS-304-1. Cable supply information can be found in NAVSUP Publication 4400, *Afloat Shopping Guide*, under federal supply classification (FSC) 6145. Hook-up or chassis wire is covered in Military Specification 76B (MIL-W-76B). Table 1-11 shows the current-carrying capacity or AMPACITY of equipment hook-up wire.

Table 1-11.—Current-Carrying Capacity of Equipment Hook-up Wire—Continued

Wire Size		Copper Conductor (100°C) Nominal Resistance (Ohms/1000 ft)	Maximum Current in Amperes			
			Copper Wire		Aluminum Wire	
AWG	Circular Mils		Wiring in Free Air	Wiring Confined	Wiring in Free Air	Wiring Confined
32	63.2	188.0	0.53	0.32		
30	100.5	116.0	0.86	0.52		
28	159.8	72.0	1.4	0.83		
26	254.1	45.2	2.2	1.3		
24	404.0	28.4	3.5	2.1		
22	642.4	22.0	7.0	5.0		
20	1022	13.7	11.0	7.5		
18	1624	6.50	16	10		
16	2583	5.15	22	13		
14	4107	3.20	32	17		
12	6530	2.02	41	23		
10	10 380	1.31	55	33		
8	16 510	0.734	73	46	60	38
6	26 250	0.459	101	60	83	50
4	41 740	0.290	135	80	108	66
2	66 370	0.185	181	100	152	82
1	93 690	0.151	211	125	174	105
0	105 000	0.117	245	150	202	123
00	133 100	0.092	283	175	235	145
000	167 800	0.074	328	200	266	162
0000	211 600	0.059	380	225	303	190

Table 1-12 lists the preferred general purpose rf cable selected by the armed services as the most satisfactory types to be used in electronics equipment.

Table 1-12.—Preferred General Purpose RF Cable

Jan Type	Overall Diameter (ins)	Impedance (OHMS)	Operating Voltage (Volts RMS)	Remarks
RG-11A/U	0.412	75.0	5,000	Medium size, flexible video cable
RG-12A/U	0.475	75.0	5,000	Same as RE-11A/U, armored
RG-34B/U	0.630	75.0	6,500	Large size, high power, low attenuation, flexible
RG-35B/U	0.945	75.0	10,000	Large size, high power, low attenuation, video and communications, armored
RG-55B/U	0.206	53.0	1,900	Small size, double braid
RG-58C/U	0.195	50.0	1,900	Small size, flexible
RG-59B/U	0.242	75.0	2,300	Small size, video
RG-84A/U	1.000	75.0	10,000	Same as RG-35B/U, except with lead sheath vice armor for underground installation
RG-85A/U	1.565	75.0	10,000	Same as RG-84A/U except with special armor
RG-164/U	0.870	75.0	10,000	Same as RG-35B/U except no armor
RG-212/U	0.332	50.0	3,000	Wave, formerly RG-5B/U
RG-213/U	0.405	50.0	5,000	Medium size, flexible, formerly RG-8A/U
RG-214/U	0.425	50.0	5,000	Medium size, double braid, flexible, formerly RG-9B/U
RG-215/U	0.475	50.0	15,000	Same as RG-214/U but armored. Formerly RG-10A/U
RG-216/U	0.425	75.0	5,000	Medium size, flexible video and communication, formerly RG-13A/U
RG-217/U	0.545	50.0	7,000	Medium size, power transmission line, formerly RG-14A/U
RG-218/U	0.870	50.0	11,000	Large size, low attenuation, high power transmission line, formerly RG-17A/U
RG-219/U	0.945	50.0	11,000	Same as RG-218/U, but armored, formerly RG-18A/U
RG-220/U	1.120	50.0	14,000	Very large, low attenuation, high power transmission line, formerly RG-19A/U
RG-221/U	1.195	50.0	14,000	Same as RG-220/U but armored, formerly RG-20A/U
RG-223/U	0.216	50.0	1,900	Small size, double braid, formerly RG-55A/U
RG-224/U	0.615	50.0	7,000	Same as RG-217/U but armored.

Specifications on special types of rf cable can be found in the *Military Standardization Handbook* 216 (MIL-HDBK-216).

Connectors

General purpose connectors and rf connectors are covered in this section. We'll cover the general purpose connectors first.

General purpose connectors were formerly designated with the prefix "AN." You may find older connectors with this prefix. The superseding connector has the same part number except the "AN" has been replaced by "MS." Table 1-13 shows the method used to break down a connector for identification. This breakdown is for MIL-C-5015 connectors. Identification breakdown for other MIL-C connectors can be found in *Naval Shore Electronics Criteria, Installation Standards and Practices*, NAVEX 0280-LP-900-8000.

Table 1-13.—MS Connector Identification

MIL-STD-1353B
30 August 1983

MIL-C-5015 PART NUMBER SYSTEM

Part No. example: MS3400D22-22S

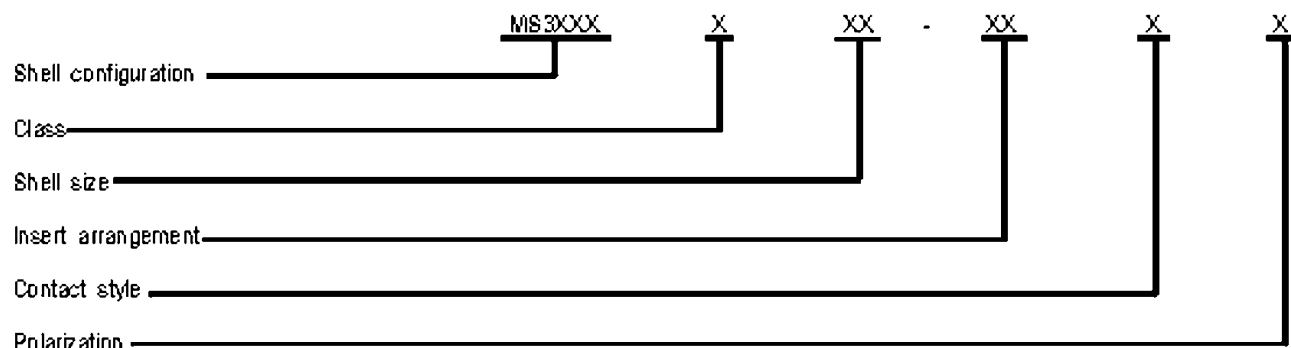

Shell configuration:	Front release crimp	Rear release crimp
Wall mounting receptacle	MS3400	MS3450
Box mounting receptacle	MS3402	MS3452
Jam nut mounting receptacle	MS3404	MS3454
Straight plug	MS3406	MS3456
Self-locking plug	-	MS3459
Cable connecting receptacle	MS3401	MS3451

Class:

- D - Environment resisting - High impact shock MS3400
 - L - Environment resisting - Fluid resistant (electroless Ni)
For "space" applications only.
 - W - Environment resisting - Fluid resistant (Cad OD over suitable underplate)
 - KS - Firewall, self-locking, stainless steel
 - KT - Firewall, self-locking, cadmium plated ferrous alloy
- } MS3450

Shell size: Shell size in 16th of an inch.

Insert arrangements: See MIL-C-STD-1651.

Contact style:

- P - Pin contact - MIL-C-39029/29 and /44.
- S - Socket contact - MIL-C-39029/30 and /45.

Polarization: Normal polarization is considered preferred; however, alternate polarizations, when required by a system, do not require nonstandard part approval.

Supply information on connectors can be found in NAVSUP Publication 4400, *Afloat Shopping Guide*, under federal supply classification (FSC) 5935.

Insert arrangements for MS type connectors, MIL-C-5015, are shown in figure 1-23. Alternate positions of connector inserts are shown in figure 1-24.

1 Contact	2 Contact	2 Contact	3 Contact	4 Contact	5 Contact	6 Contact	7 Contact
8S-1	16S-4	32-5	22-9	20-4	18-20	14S-6 *	20-15
10S-2	16-11		22-21	20-20	18-29	18-12	22-26
12S-4	16-13	3 Contact	22-21	20-20	20-14 *	20-8	22-28
12-5	18-3	10SL-3 *	24-14	20-24	22-12	20-17	22-29
14-3	18-14	14S-1	28-3	22-4	22-13	20-22 *	22-33
14S-4	18-404	14S-7 *	28-6	22-10	22-34	22-5	24-2
16-2	20-5	16S-5	36-4	22-22 *	24-12	22-15	24-3
16S-3	20-12	16S-6	4 Contact	24-4	24-17	22-24	24-10
16-12	20-23	16-7	12SL-844	4-22	24-23	28-22 *	24-16
18-6	22-1	16-10 *	145-2 *	32-17	28-5	36-3	24-27
18-7	22-3	18-5	16-9 *	36-5	32-1	36-6	28-10
18-16	22-8	18-22	18-4	5 Contact	32-2	7 Contact	32-10
18-420	22-11	20-3	18-10	14S-5	36-2		16S-1 *
20-2	24-1	20-6	18-13	16S-8		18-9	
22-7	24-1	20-19	18-15	18-11 *			
24-835	28-7	22-2					
2 Contact		22-6					
10SL-4							
12S-3 *							
12S-6							
14S-9							

* INDICATES AIR STANDARDS COORDINATING COMMITTEE PREFERRED.
 NOTE: FACE VIEW OF PIN INSERTS. ALL INSERTS SHOWN IN NORMAL POSITION.

Figure 1-23.—Insert arrangements type connectors, MIL-C-5015.

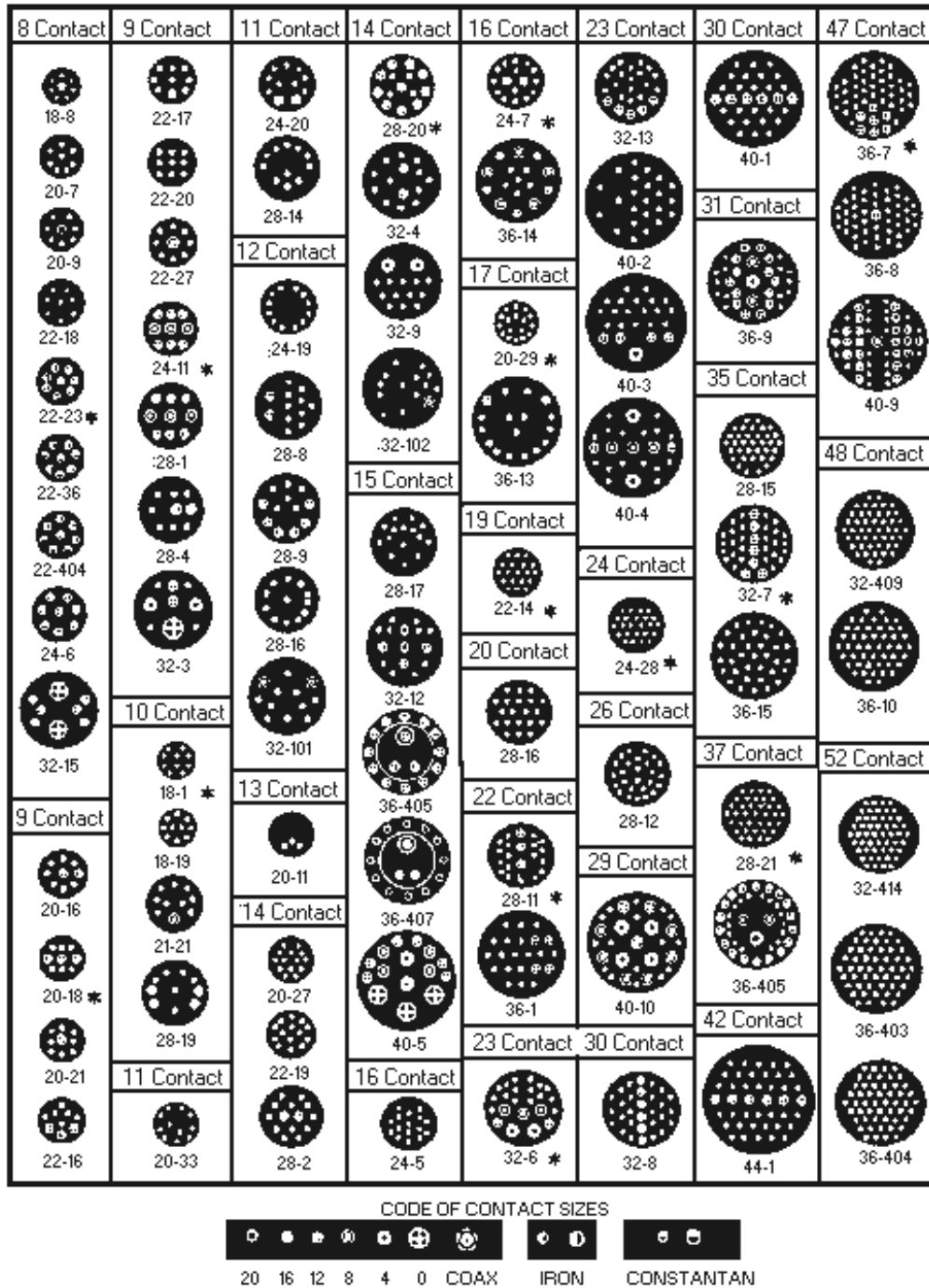

Figure 1-23.—Insert arrangements type connectors, MIL-C-5015. —Continued.

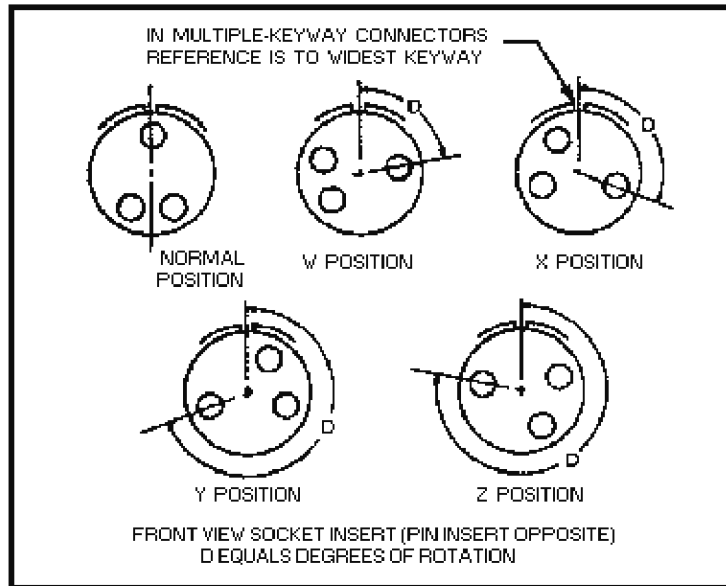

Figure 1-24.—Alternate positions of connector inserts.

MIL-C-5015, MIL-C-26482, and MIL-C-26500 connectors are designated with an MS number such as MS3101. MIL-C-81511, MIL-C-83723, and other later specifications identify the connector by the specification number, a slash, and the connector number. For example: MIL-C-81511/3.

Rf connectors and coaxial cable assemblies are used to carry radio frequency (rf) power from one point to another with a known rate of loss. Rf connectors are available as plugs, jacks, panel jacks, and receptacles. Plugs and jacks are attached to the ends of coaxial cables; panel jacks and receptacles are mounted to panels and chassis.

Baby N connector (**BNC**) series connectors are small, lightweight, and feature a quick connect/disconnect, bayonet-lock coupling. The connectors use small rf cables such as **RG-58/U** or **RG-59/U** and operate up to peak voltages of 500 volts. Manufacture is under Military Specification C-3608A (MIL-C-3608A). Figure 1-25 shows three typical **BNC** connectors. Figure 1-26 shows you how to attach **BNC** connectors to coaxial cable. Table 1-14 indicates which **BNC** connector to use with what coaxial cable type.

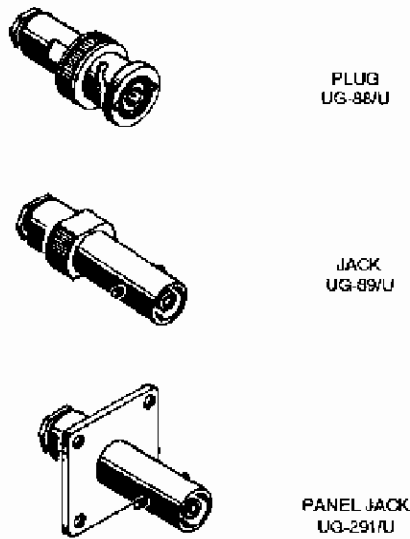

Figure 1-25.—Typical BNC connectors.

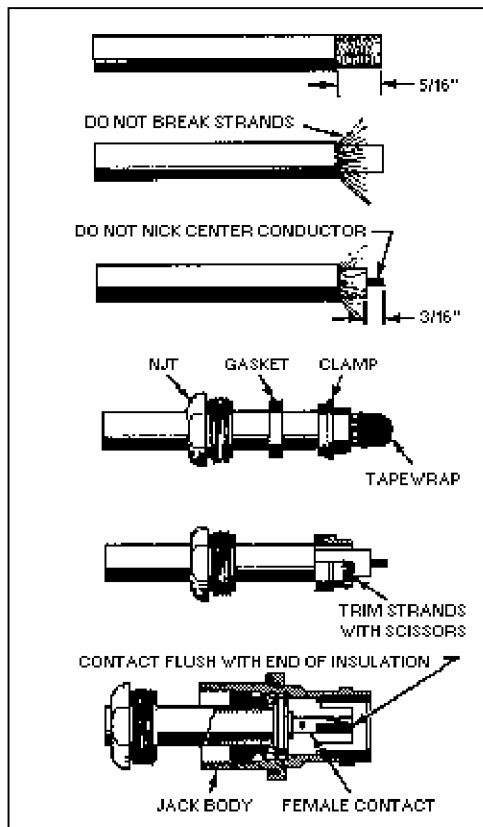

Figure 1-26.—Attaching BNC connectors to coaxial cable.

Table 1-14.—BNC Series Connectors with Associated Cables

Plug	Jack	Panel Jack	For Use With Cable Types
Improved Version: UG-88E/U	UG-89C/U	UG-291C/U	RG-55/U, 58/U and 223/U
UG-260D/U	UG-261C/U	UG-262C/U	RG-59/U, 62/U and 71/U
Captivated Contact Version (Amphenol):			
31-301	31-302	31-300	RG-55/U, 58/U, 141/U and 142/U
31-304	31-305	31-303	Rg-59/U, 62/U, 71/U and 140/U

HN series connectors have a 50-ohm impedance and threaded coupling connectors designed for high-voltage applications. These connectors are weatherproof. The frequency range is 0-4 gigahertz. The **HN** series is used with medium size coaxial cable such as **RG-8/U**, **RG-9/U**, **RG-87/U**, **RG-213/U**, **RG-214/U**, and **RG-225/U**. Figure 1-27 shows three typical **HN** connectors. Figure 1-28 shows how **HN** connectors are attached to coaxial cable. Table 1-15 indicates which **HN** connector to use with what coaxial cable type.

N series connectors are low-voltage, 50-ohm, threaded coupling connectors designed for use with small and medium size rf cable. They have a 1,000 volts peak rating and are weatherproof. There is a group of **N** series connectors that are 70 ohms and are numbered **UG-98A/U** and **UG-96A/U**. These 70-ohm **N** connectors are designed for cables such as **RG-61C**, **RG-11/U**, and **RG-13/U**. The 70-ohm connectors will not mate with 50-ohm connectors of this series. Figure 1-29 shows three typical **N** series connectors. Figure 1-30 illustrates the method used to attach **N** connectors to coaxial cable. Table 1-16 shows which **N** connector to use with what rf cable type.

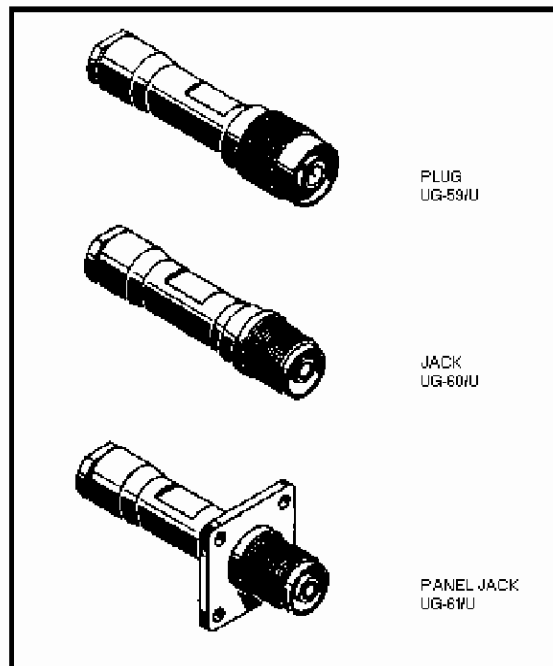

Figure 1-27.—Typical HN connectors.

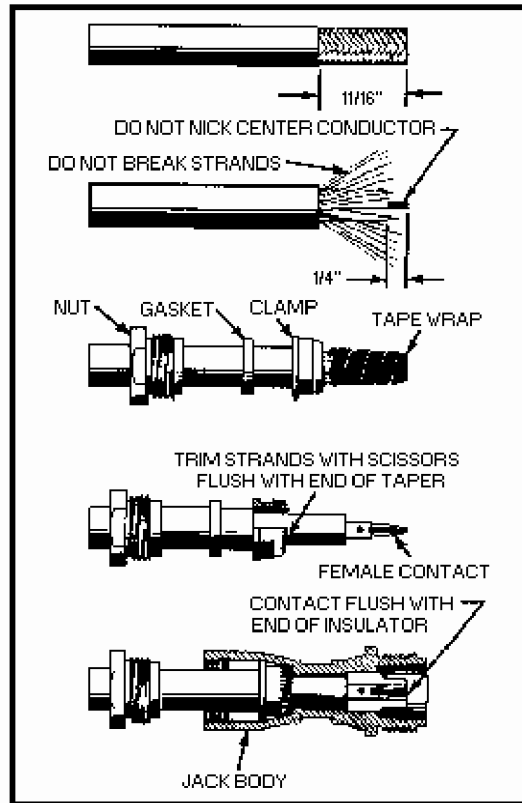

Figure 1-28.—Attaching HN connectors to coaxial cable.

Table 1-15.—HN Series Connectors with Associated Cables

Plug	Jack	Panel Jack	For Use With Cable Types
*UG-59E/U	*UG-60E/U	*UG-61E/U	RG8/U, 9/U,
**UG-1213/U	**UG-1214/U	**UG-1215/U	213/U and 214/U
Improved Version; **Captivated Contact Version			

C series connectors are weatherproof, quick-connect/disconnect, bayonet-locking type connectors. They are used with medium size cables, such as **RG-5/U**, **RG-8/U**, and **RG-9/U**. They operate up to a peak of 1,000 volts and at frequencies up to 10 gigahertz. Their impedance is 50 ohms. Figure 1-31 shows three typical C series connectors. Figure 1-32 shows you how to attach the C series connectors to a coaxial cable.

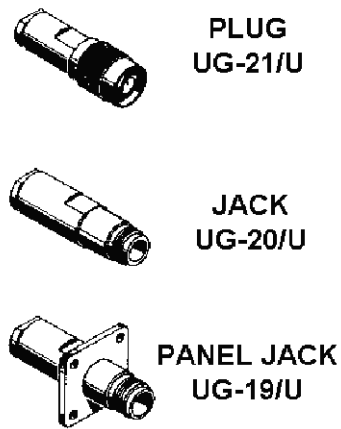

Figure 1-29.—Typical N connectors.

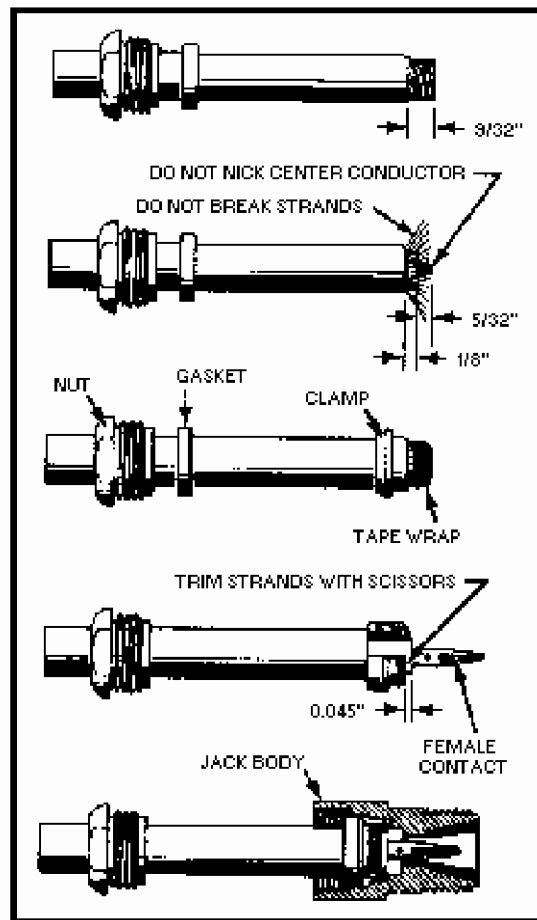

Figure 1-30.—Attaching N connectors to coaxial cable.

Table 1-16.—N Series Connectors with Associated Cables

<u>Plug</u>	<u>Jack</u>	<u>Panel Jack</u>	<u>For Use With Cable Types</u>
Improved Version: UG-18D/U	UG-20D/U	UG-19D/U	RG-5/U, 6/U, 21/U and 212/U
UG-21E/U UG-594A/U UG-536B/U	UG-23E/U	UG-23E/U UG-160D/U	RG-8/U, 9/U, 213/U and 214/U RG-55/U and 58/U
Captivated Contact Version: UG-1185/U	UG-1186/U	UG-1187/U	RG-8/U,9/U,213/ U AND 214/U

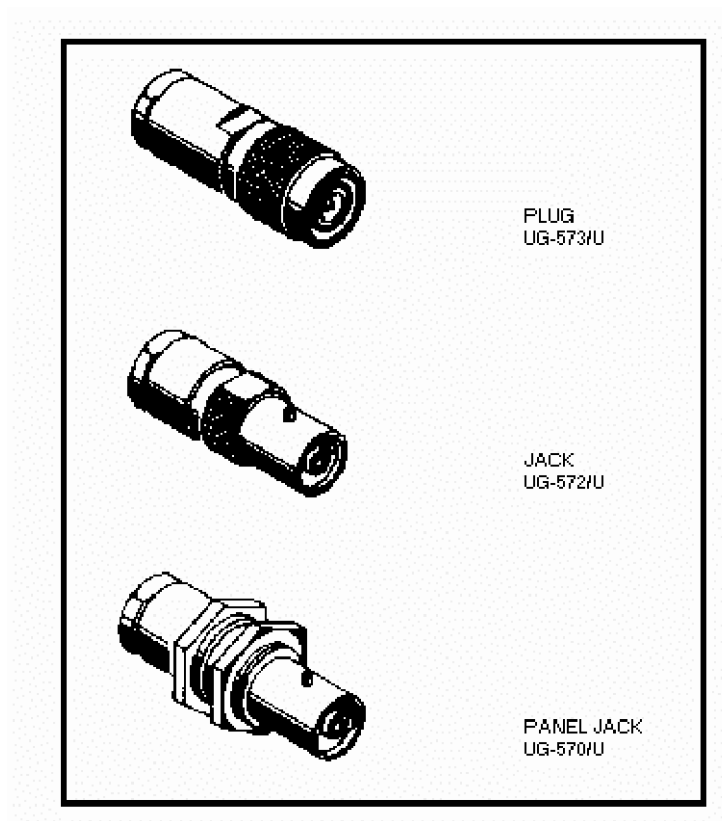

Figure 1-31.—Typical C connectors.

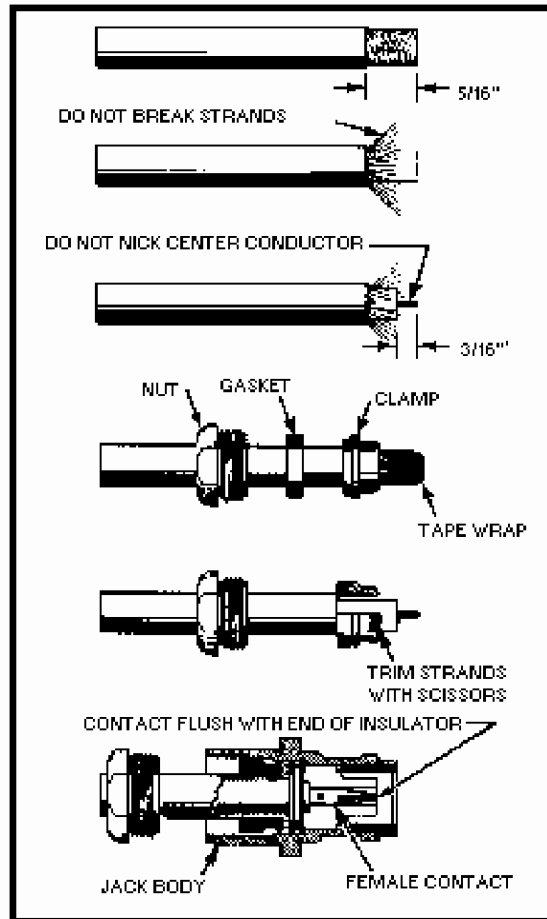

Figure 1-32.—Attaching C connectors to coaxial cable.

Table 1-17.—C Series Connectors with Associated Cables

Plug	Jack	Panel Jack	For Use With Cable Types
UG-573B/U	UG-572A/U	UG-570A/U	RG-8/U, 9/U, 213/U and
UG-701B/U		UG-571A/U	214/U
UG-626B/U	UG-633A/U	UG-629A/U	RG-5/U, 6/U, and 212/U
UG-707A/U		UG-630A/U	
			RG-14/U and 217/U

You can find more information on rf connectors in *Military Handbook 216 (MIL-HDBK-216)*.

Insulation, Heat Shrinkable Sleeving (Shrink, Tubing), and Cable Straps

Heat shrinkable sleeving is intended for use as a snug-fitting electrical insulator. It is used to insulate wire bundles, splices, bus bars, connectors, terminals, metal, or fibrous tubing. It is also used as extra insulation over hotspot areas and as a cable blast shield in rocket launchings. Heat shrinkable sleeving is found under Military Specification I-23053C (MIL-1-23053C). Part numbers under this military specification are coded as follows:

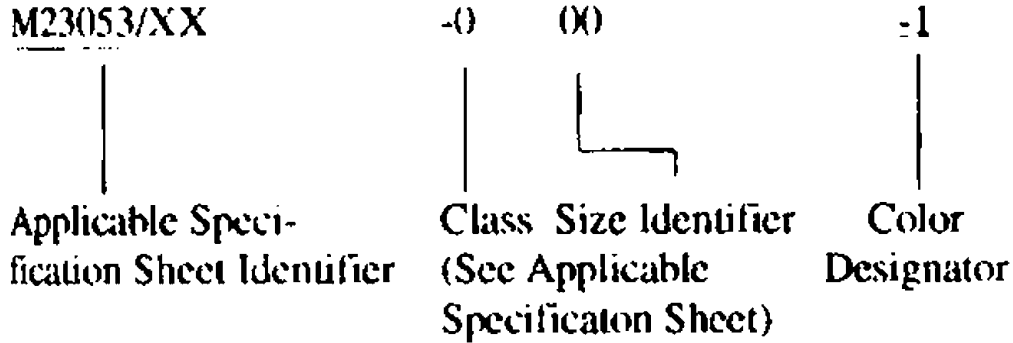

Color code designations are:

DESIGNATOR	COLOR	DESIGNATOR	COLOR
0	Black	7	Violet (Purple)
1	Brown	8	Gray (Slate)
2	Red	9	White
3	Orange	C	Clear
4	Yellow	P	Pink
5	Green	T	Tan
6	Blue		

The particular uses for heat shrinkable sleeving depend on the specific properties described by the individual specification sheet. Intended uses are indicated below:

Military
Part Number

- M23053/1: Intended for use on heavy duty cables or harness systems such as ground support.
- /2 and /3: Used for light-duty harnessing or wire bundling.
- /4: Used for one-step potting, encapsulation, or moisture sealing and corrosion protection of electrical components or terminations.
- /5: Used for light-duty harness jackets, wire color coding, marking, or identification.
- /6: Used for wire identification, marking, or strain relief.
- /7: Used for light-duty wire identification and component covering.
- /8: Used for wire or termination strain relief at elevated temperatures.
- /9: Canceled.
- /10: Used for high-or low-temperature applications or where resistance to melting in high-blast flame is required.
- /11: Used where strain relief is necessary at high temperatures.
- /12: Used at high temperatures where resistance to flame is important to protect high-temperature cable, components, and terminations.
- /13: Used in elevated-temperature applications or where exposure to elevated-temperature solvents is expected.
- /14: Used as component and electronic lead strain relief where low expansion ratios are satisfactory. Operates over a fairly wide temperature range.
- /15: Used for repair of heavy duty cables and splice covers.
- /16: Used on heavy duty cables or harness systems that are subjected to high levels of physical abuse and exposure to fuels and oils coupled with high-and low- temperature extremes.

Tables 1-18 and 1-19 provide part numbers for two types of shrinkable tubing, **M23053/5** and **M23053/4**. These were chosen because of their wide range of sizes (**M23053/5**) and their abilities to provide potting, encapsulating, or moisture sealing of electrical components (**M23053/4**).

Table 1-18.—Shrinkable Tubing Part Numbers

Military Part Number	As supplied	After unrestricted shrinkage
	I.D. min.	I. D. max.
<u>Class 1</u>	Inches	Inches
M23053/5-101-*	.046	.023
M23053/5-102-*	.063	.031
M23053/5-103-*	.093	.046
M23053/5-104-*	.125	.062
M23053/5-105-*	.187	.093
M23053/5-106-*	.250	.125
M23053/5-107-*	.375	.187
M23053/5-108-*	.500	.250
M23053/5-109-*	.750	.375
M23053/5-110-*	1.000	.500
M23053/5-111-*	1.500	.750
M23053/5-112-*	2.000	1.000
M23053/5-113-*	3.000	1.500
M23053/5-114-*	4.000	2.000

* Asterisk in the part number shall be replaced by color code designations.

Table 1-19.—Shrinkable Tubing Part Numbers

Military Part Number	As supplied		After unrestricted shrinkage	
	I.D. min.		I.D. max.	
<u>Class 1</u>		Inches		Inches
M23053/4-101-*	.125	↓	.023	↓
M23053/4-102-*	.187		.060	
M23053/4-103-*	.250		.080	
M23053/4-104-*	.375		.135	
M23053/4-105-*	.500		.195	
M23053/4-106-*	.750		.313	
M23053/4-107-*	1.000		.400	
M23053/4-108-*	.300		.050	
<u>Class 2</u>				
M23053/4-201-*	.238	↓	.125	↓
M23053/4-202-*	.355		.187	
M23053/4-203-*	.475		.250	
M23053/4-204-*	.712		.375	
M23053/4-205-*	.950		.500	
M23053/4-206-*	1.425		.750	
Class 1 = Semi-rigid, flame retardant Class 2 = Flexible, flame retardant * Asterisk in the part number shall be replaced by color code designations.				

When ordering, you should replace the asterisk (*) in the part number with the color code designation.

For example: The part number for **M23053/4**, one-half inch, class 1, black shrinkable tubing would be **M23053/4-105-0**.

Table 1-20 provides data on adjustable nylon cable straps. These straps are adjustable only in one direction. They are not designed to be loosened.

Table 1-20.—Adjustable Nylon Cable Strap Data

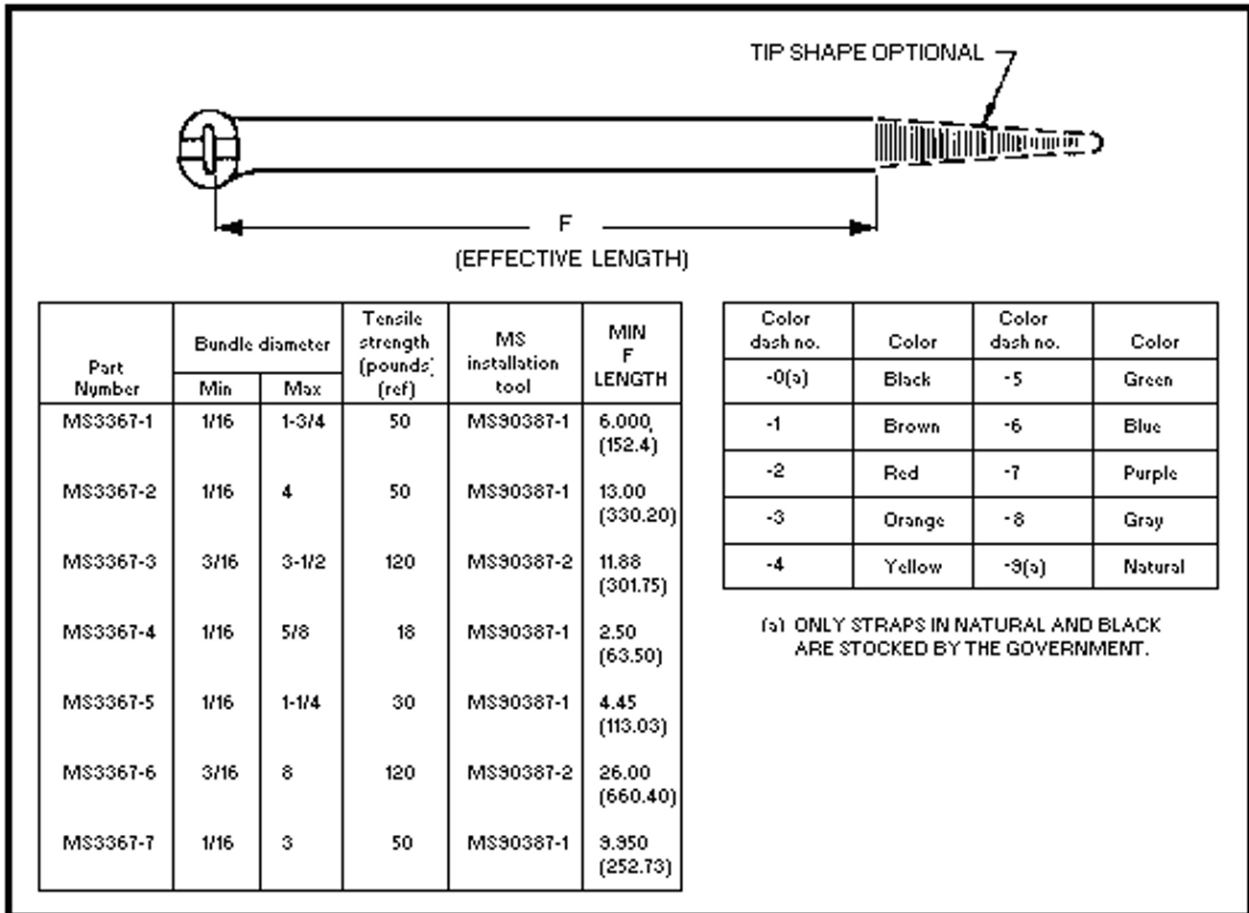

Fuses and Circuit Breakers

New type military fuse designations can be identified by using table 1-21. Old style military fuse designations can be identified by using table 1-22.

Table 1-21.—New Style Military Fuse Identification

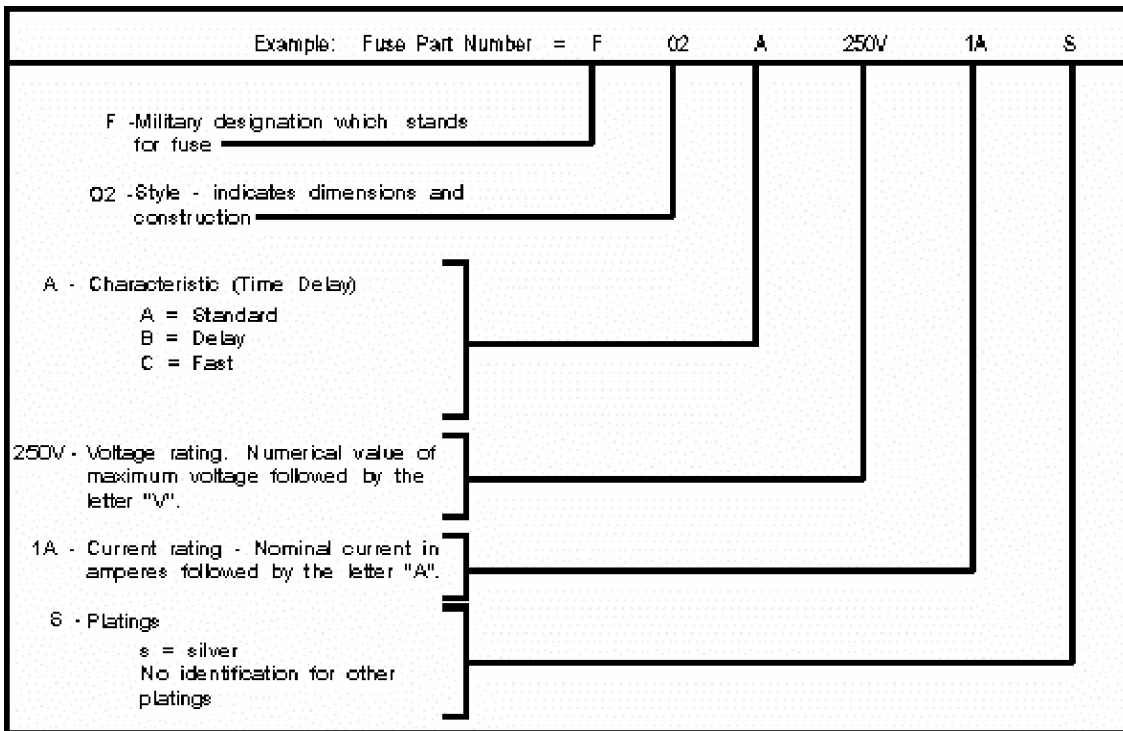
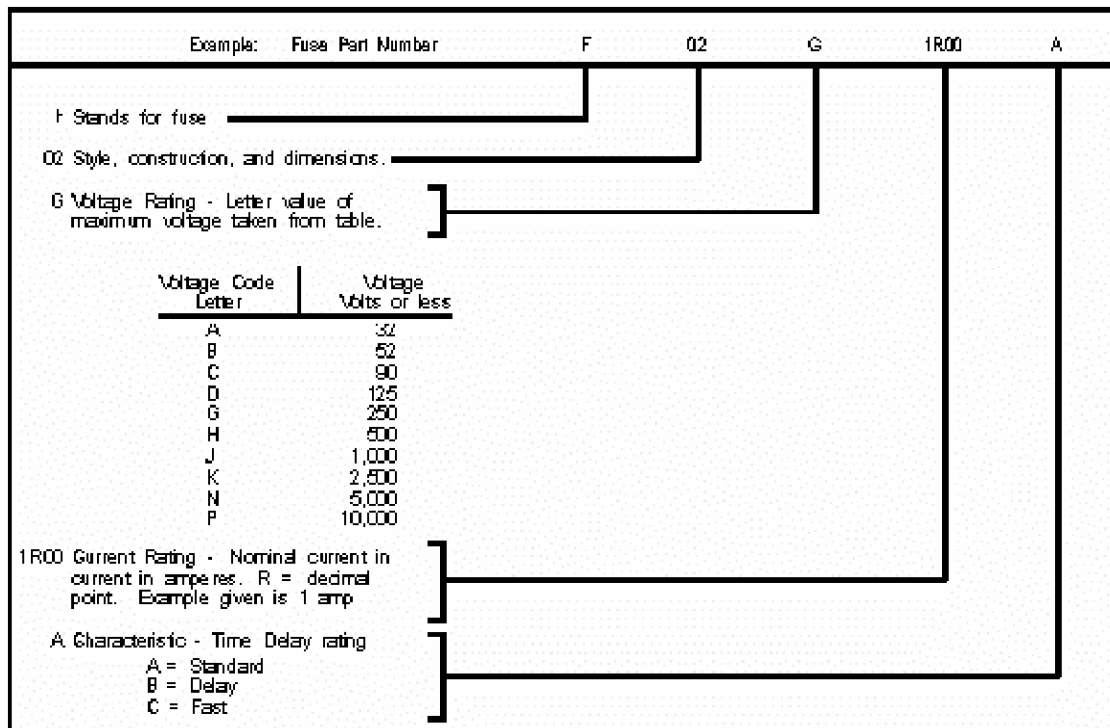

Table 1-22.—Old Style Military Fuse Identification



Commercial fuse identification and a fuse cross-reference can be found in NEETS, Module 3, *Introduction to Circuit Protection, Control, and Measurement*; and in Military Standard 1360A (MIL-STD-1360A). These will assist you in selecting or identifying fuses.

Circuit breakers are too numerous to cover in this text. They are used in houses, vehicles, ships, and airplanes. Military Standard 1498 (MIL-STD-1498) contains information to help you select or identify circuit breakers.

Classification of Rf Emissions

The system of designating rf emissions is arranged according to modulation type, mode, and supplementary characteristics. For example: **A3B** indicates amplitude modulation, telephony, two independent sidebands, and a suppressed carrier. Table 1-23 will assist you in breaking down the emission classification code.

Table 1-23.—Emission Types

Emission	Type
Modulation Types	
Amplitude	A
Frequency	F
Pulse	P
Modulation (Transmission Mode)	
None	0
Telegraphy (keyed r-f carrier)	1
Telegraphy (tone)	2
Telephony	3
Facsimile	4
Television	5
Four Channel Diplex Telegraphy	6
Multichannel Voice Frequency Telegraphy Complex	7
Forms	
Supplemental Characteristics	
Double Sideband	none
Single Sideband	
-reduced carrier	A
-full carrier	H
-suppressed carrier	J
Two Independent Sidebands	
-suppressed carrier	B
Vestigial Sideband Pulse	C
-amplitude modulated	D
-width modulated	E
-phase modulated	F
-code modulated	G

*Capital or lower case letter

**Commercial practice is to reduce carrier 20 dB, to provide sufficient carrier for receiver afc lock-in, where afs receivers are used.

Note: a number preceding the emission designation indicates the bandwidth in kilohertz.

Conversion and Equivalent Tables

Table 1-24 provides the multiplying factors necessary to convert from one unit of measure to another and vice versa.

Table 1-24.—Conversion Chart

To Convert	To	Multiply By	Conversely, Multiply By
Acres	Square feet	4.356×10^4	2.296×10^{-5}
Acres	Square meters	4047	2.471×10^{-4}
Ampere-hour	Coulombs	3600	2.778×10^{-4}
Amperes	Microamperes	1,000,000	0.000,001
Amperes	Milliamperes	1,000	0.001
Amperes per sq cm	Amperes per sq in	6.452	0.1550
Amperes-turns	Gilberts	1.257	0.7958
Amperes-turns per cm	Amperes-turns per inch	2.540	0.3937
Amperes-turns per cm	Oersteds	1.257	0.7958
Ampere-turns per in	Oersteds	0.495	2.02
Ampere-turns per meter	Oersteds	.01257	79.58
Ampere-turns per weber	Gilberts per maxwell	1.257×10^{-8}	7.958×10^7
Atmospheres	MM of mercury at 0° C	760	1.316×10^{-8}
Atmospheres	Feet of water at 4° C	33.90	2.950×10^{-2}
Atmospheres	Inches of mercury at 0° C	29.92	3.342×10^{-2}
Atmospheres	Kilograms per sq meter	1.033×10^4	9.678×10^{-5}
Atmospheres	Pounds per sq inch	14.70	6.804×10^{-2}
BTU	Foot-pounds	778.3	1.285×10^{-3}
BTU	Joules	1054.8	9.480×10^{-4}
BTU	Kilogram-calories	0.2520	3.969
BTU per hour	Horsepower-hours	3.929×10^{-4}	2545
Bushels	Cubic feet	1.2445	0.8036
Celsius (Centigrade) deg	Fahrenheit deg	$(^{\circ} \text{C} \times 9/5) + 32$	$(^{\circ} \text{F} - 32) \times 5/9$
Circular Mils	Sq centimeters	5.067×10^{-6}	1.973×10^5
Circular mils	Square mils	0.7854	1.273
Cubic feet	Cords	7.8125×10^{-3}	128
Cubic feet	Gallons (liquid US)	7.481	0.1337
Cubic feet	Liters	28.32	3.531×10^{-2}
Cubic inches	Cubic centimeters	16.39	6.102×10^{-2}
Cubic inches	Cubic feet	5.787×10^{-4}	1728
Cubic inches	Cubic meters	1.639×10^{-5}	6.102×10^{-4}
Cubic inches	Gallons (liquid US)	4.329×10^{-3}	231
Cubic meters	Cubic feet	35.31	2.832×10^{-2}
Cubic meters	Cubic yards	1.381	0.7646
Degrees (angle)	Radians	1.745×10^{-2}	57.30
Dynes	Pounds	2.248×10^{-6}	4.448×10^5
Ergs	Foot-pounds	7.367×10^{-8}	1.356×10^7
Fards	Microtarads	1,000,000	0.000,001
Farads	Picofarads	1,000,000,000,000	0.000,000,000,001
Fathoms	Feet	6	0.16666

Table 1-24.—Conversion Chart—Continued

To Convert	To	Multiply By	Conversely, Multiply By
Feet	Centimeters	30.48	3.281×10^{-2}
Feet	Varas	0.3594	2.782
Feet of water at 4° C	Inches of mercury at 0° C	0.8826	1.133
Feet of water at 4° C	Kilograms per sq meter	304.8	3.281×10^{-3}
Feet of water at 4° C	Pounds per sq foot	62.43	1.602×10^{-2}
Foot-pounds	Horsepower-hours	5.050×10^{-7}	1.98×10^{-6}
Foot-pounds	Kilogram-meters	0.1383	7.233
Foot-pounds	Kilowatt-hours	3.766×10^{-7}	2.655×10^6
Gallons	Cubic meters	3.785×10^{-8}	264.2
Gallons (liquid US)	Gallons (liquid Br Imp)	0.8327	1.201
Gausses	Lines per sq inch	6.452	0.1550
Gilberts per cm	Oersteds	1	1
Grains (for humidity calculations)	Pounds (avoirdupois)	1.429×10^{-4}	7000
Grams	Dynes	980.7	1.020×10^{-3}
Grams	Grains	15.43	6.481×10^{-2}
Grams	Ounces (avoirdupois)	3.527×10^{-2}	28.35
Grams	Poundals	7.093×10^{-2}	14.10
Grams per cm	Pounds per inch	5.600×10^{-3}	178.6
Grams per cu cm	Pounds per cu in	3.613×10^{-3}	27.68
Grams per sq cm	Pounds per sq ft	2.0481	0.4883
Hectares	Acres	2.471	0.4047
Henrys	Microhenrys	1,000,000	0.000,001
Henrys	Millihenrys	1000	0.001
Henrys per meter	Gausses per Oersted	7.958×10^5	1.257×10^{-6}
Horsepower (boiler)	BTU per hour	3.347×10^4	2.986×10^{-5}
Horsepower (metric) (542.5 ft-lb per sec)	BTU per minute	41.83	2.390×10^{-2}
Horsepower (metric) (542.5 ft-lb per sec)	Ft-lb per minute	3.255×10^4	3.072×10^{-5}
Horsepower (metric) (542.5 ft-lb per sec)	Kilogram-calories per min	10.54	9.485×10^{-2}
Horsepower (550 ft-lb per sec)	BTU per minute	42.41	2.357×10^{-2}
Horsepower (550 ft-lb per sec)	Ft-lb per minute	3.3×10^4	3.030×10^{-5}
Horsepower (550 ft-lb per sec)	Kilowatts	0.745	1.342
Horsepower (550 ft-lb per sec)	Watts	746	1.342×10^{-3}
Horsepower (metric) (542.5 ft-lb per sec)	Horsepower (550 ft-lb per sec)	0.9863	1.014
Horsepower (550 ft-lb per sec)	Kilogram-calories per min	10.69	9.355×10^{-2}

Table 1-24.—Conversion Chart—Continued

To Convert	To	Multiply By	Conversely, Multiply By
Inches	Centimeters	2.540	3.3937
Inches	Feet	8.33×10^{-2}	12
Inches	Miles	1.578×10^{-5}	6.336×10^4
Inches	Mil	1000	0.001
Inches	Yards	2.778×10^{-2}	36
Inches of mercury at 0° C	Pounds per sq inch	0.4912	2.036
Inches of water at 4° C	Kilograms per sq meter	25.40	3.937×10^{-2}
Inches of water at 4° C	Ounces per sq inch	0.5782	1.729
Inches of water at 4° C	Pounds per sq foot	5.202	0.1922
Inches of water at 4° C	Inches of mercury	7.355×10^{-2}	13.60
Joules	Foot-pounds	0.7376	1.356
Joules	Ergs	10 ⁷	10 ⁻³
Kilogram-calories	Kilogram-meters	426.9	2.343×10^3
Kilogram-calories	Kilojoules	4.186	0.2389
Kilograms	Tons, long (avdp 2240 lb)	9.842×10^{-4}	1016
Kilograms	Tons, short (avdp 2000 lb)	1.102×10^{-8}	907.2
Kilograms	Pounds (avoirdupois)	2.205	0.4536
Kilograms per sq meter	Pounds per sq foot	0.2048	4.882
Kilometers	Feet	3281	3.048×10^{-4}
Kilovolts	Volts	1000	0.001
Kilowatt-hours	BTU	3413	2.930×10^{-4}
Kilowatt-hours	Foot-pounds	2.655×10^6	3.766×10^{-7}
Kilowatt-hours	Joules	3.6×10^7	2.778×10^{-7}
Kilowatt-hours	Kilogram-calories	860	1.163×10^{-3}
Kilowatt-hours	Kilogram-meters	3.671×10^5	2.724×10^{-7}
Kilowatt-hours	Pounds carbon oxidized	0.235	4.26
Kilowatt-hours	Pounds water evaporated from and at 212° F	3.53	0.283
Kilowatt-hours	Pounds water raised from 32° to 212° F	24.52	4.078×10^{-2}
Kilowatts	Watts	1000	0.001
Leagues	Miles	2.635	0.3795
Lines per inch 2	Gausses	0.1550	6.452
Liters	Bushels (dry, US)	2.838×10^{-2}	35.24
Liters	Cubic Centimeters	1000	0.001
Liters	Cubic meters	0.001	1000
Liters	Cubic inches	61.02	1.639×10^{-2}
Liters	Gallons (liq US)	0.2642	3.785
Liters	Pints (liq US)	2.113	0.4732
Log N	Log 10N	0.4343	2.303
Lumens per sq ft	Foot-candles	1	1
Lux	Foot-candles	0.0929	10.764
Maxwells	Lines	1	1
Maxwells	Webers	10 ⁻²	10 ⁸

Table 1-24.—Conversion Chart—Continued

To Convert	To	Multiply By	Conversely, Multiply By
Maxwells per cm ²	Gausses	1	1
Meters	Yards	1.094	0.9144
Meters	Varas	1.179	0.848
Meters per min	*Knots (naut mi per hour)	30.866	30.866
Meters per min	Feet per minute	3.281	0.3048
Meters per min	Kilometers per hour	0.06	16.67
Mhos	Micromhos	1,000,000	0.000,001
Microhms per cm cube	Microhms per inch cubs	0.3937	2.540
Miles (nautical)	Feet	6076.103	1.645 " 10 ⁻⁴
Miles (nautical)	Kilometers	1.852	0.5396
Miles (statute)	Kilometers	1.609	0.6214
Miles (statute)	*Miles (nautical)	0.8688	1.151
Miles (statute)	Fast	5280	1.894 " 10 ⁻⁴
Miles par hour	Kilometers per mi	2.682 " 10 ⁻²	37.28
Miles per hour	Feet per minute	88	1.136 " 10 ⁻²
Miles par hour	*Knots (naut mi per hr)	0.8688	1.151
Miles per hour	Kilometers per hour	1.609	0.6214
Nepers	Decibels	8.686	0.1151
Picofarads	Microfarads	0.000,001	1,000,000
Pounds of water (dist)	Cubic feet	1.603 " 10 ⁻²	62.38
Pounds of water (dist)	Gallons	0.1198	8.347
Pounds per cu ft	Kilograms per cu meter	16.02	6.243 " 10 ⁻²
Pounds per cu inch	Pounds per cu foot	1728	5.787 " 10 ⁻⁴
Pounds per sq ft	Pounds per sq inch	6.944 " 10 ⁻³	144
Pounds per sq in	Kilograms per sq meter	703.1	1.442 " 10 ⁻³
Poundals	Dynes	1.383 " 10 ⁴	7.233 " 10 ⁻⁵
Poundals	Pounds (avoirdupois)	3.108 x 10 ⁻²	32.17
Radians	Mils	10 ³	10 ⁻³
Radians	Minutes	3.438 x 10 ³	2.909 " 10 ⁻⁴
Radians	Seconds	2.06265 " 10 ⁵	4.848 " 10 ⁻⁶
Slugs	Pounds	32.174	3.108 " 10 ⁻²
Sq inches	Circular mils	1.273 " 10 ⁶	7.854 " 10 ⁻⁷
Sq inches	Sq centimeters	6.452	0.1550
Sq feet	Sq meters	9.290 " 10 ⁻²	10.76
Sq miles	Sq yards	3.098 " 10 ⁻⁶	3.228 " 10 ⁻⁷
Sq miles	Acres	640	1.562 " 10 ⁻³
Sq miles	Sq kilometers	2.590	0.3861
Sq millimeters	Circular mils	1973	5.067 " 10 ⁻⁴
Tons, short (avdp 2000 lb)	Tonnes (1000 kg)	0.9072	1.102
Tons, long (avdp 2240 lb)	Tonnes (1000 kg)	1.016	0.9842
Tons, long (avdp 2240 lb)	Tons, short (avdp 2000 lb)	1.120	0.8929
Tons, (U.S. Shipping)	Cubic feet	40	0.025
Watts	BTU per minute	5.689 " 10 ⁻²	17.58
Watts	Ergs per second	107	10 ⁻⁷

Table 1-24.—Conversion Chart—Continued

To Convert	To	Multiply By	Conversely, Multiply By
Watts	Ft-lb per minute	44.26	2.260×10^{-2}
Watts	Horsepower (550 ft-lb per sec)	1.341×10^{-3}	745.7
Watts	Horsepower (metric) (542.5 ft-lb per sec)	1.360×10^{-3}	735.5
Watts	Kilogram-calories per min	1.433×10^{-2}	69.77
Webers	Volt-seconds	.1	1
Webers per ampere-turn	Maxwell per gilbert	7.958×10^{-7}	1.257×10^{-8}
Webers per Meter ²	Gausses	10^4	10^{-4}

Electrical, Electronic/Logic, and Fiber Optic Symbols.

Figures 1-33, 1-34, and 1-35 contain symbols used in electrical, electronic/logic, and fiber optic circuits.

SHIPBOARD SYMBOLS		GRAPHIC SYMBOLS	
<u>APPLIANCES, MISCELLANEOUS WIRING (GENERAL)</u>		<u>CONTROLLER, MOTOR (GENERAL)</u>	
<u>BOXES, GENERAL</u>		BUILDUP EXAMPLES	
BRANCH		CONTROLLER WITH LOW VOLTAGE RELEASE, RECLOSES UPON RETURN OF POWER	
CONNECTION		CONTROL WITH LOW VOLTAGE PROTECTION, REMAINS OPEN UPON RETURN OF POWER	
DISTRIBUTION			
JUNCTION			
<u>BUS TRANSFER EQUIPMENT</u>		<u>FANS</u>	
NONAUTOMATIC OR PUSHBUTTON CONTROL		FAN, PORTABLE BRACKET	
AC		FAN, OVERHEAD	
DC		<u>HEATERS</u>	
<u>COMMUNICATION EQUIPMENT</u>		HEATER, GENERAL	
BOX SWITCH, TELEPHONE		HEATER, PORTABLE RADIANT	
JACKS		<u>LIGHTING UNITS</u>	
PLUGS, TELEPHONE		BULKHEAD	
<u>RECEPTACLE OR OUTLET</u>		BULKHEAD, BERTH	
		HAND LANTERN	
<u>SWITCH</u>		NAVIGATIONAL	
PUSHBUTTON		NIGHT FLIGHT	
ON - OFF		OVERHEAD	
SELECTOR		PORTABLE	
CIRCUIT LETTER		OVERHEAD, FLOURESCENT	
PANEL OR BULKHEAD			
NUMBER OF SECTIONS			
SNAP			
TRANSFER			
			<u>RESISTORS</u>
			GENERAL TAPPED
			ADJUSTABLE TAP
			CONTINUOUSLY VARIABLE
			NONLINEAR
			<u>CAPACITORS</u>
			POLARIZED FIXED VARIABLE TRIMMER
			GANGED SHIELDED
			SPLIT - STATOR FEED - THROUGH
			<u>INDUCTIVE COMPONENTS</u>
			GENERAL
			MAGNETIC CORE
			TAPPED
			ADJUSTABLE
			ADJUSTABLE OR CONTINUOUSLY ADJUSTABLE
			SATURABLE CORE REACTOR
			<u>TRANSFORMERS</u>
			GENERAL MAGNETIC CORE TRANSFORMER
			AUTOTRANSFORMER WITH TAPS, SINGLE - PHASE

Figure 1-33.—Electrical symbols.

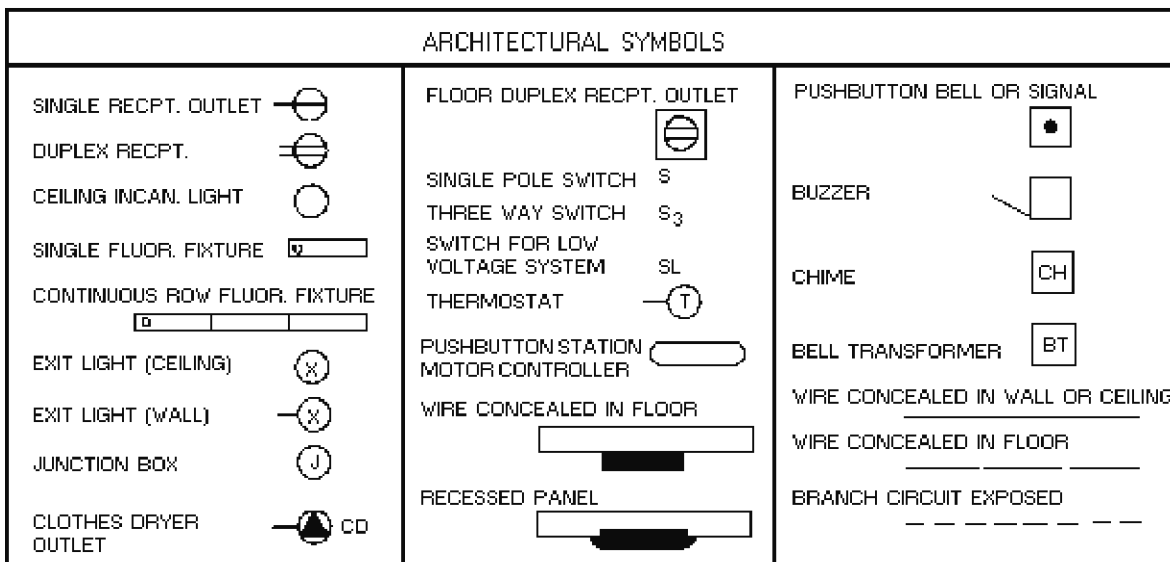
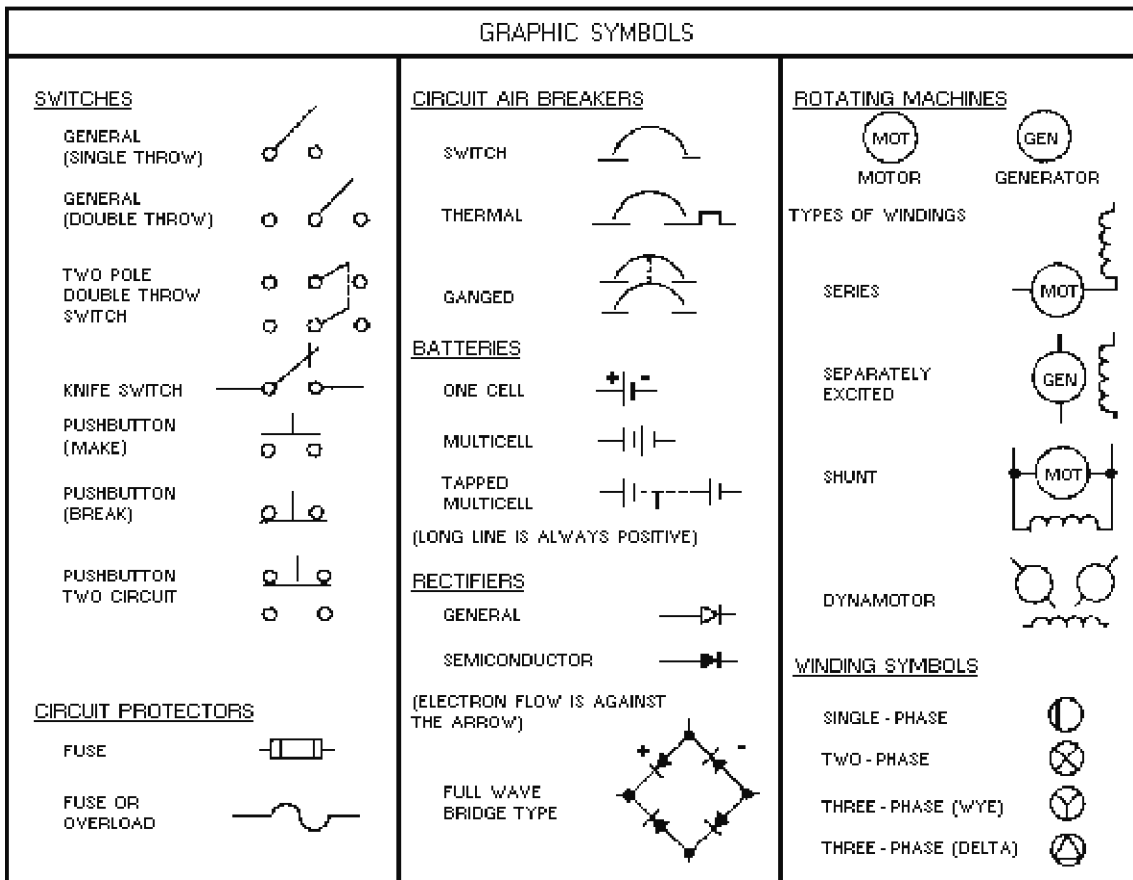





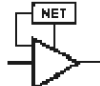













Figure 1-33.—Electrical symbols.—Continued.

<p>AMPLIFIER (2)*</p> <p>GENERAL</p>  <p>WITH TWO INPUTS</p>  <p>WITH TWO OUTPUTS</p>  <p>WITH ADJUSTABLE GAIN</p>  <p>WITH ASSOCIATED POWER SUPPLY</p> 	<p>WITH ASSOCIATED ATTENUATOR</p>  <p>WITH EXTERNAL FEEDBACK PATH</p>  <p>AMPLIFIER LETTER COMBINATION (AMPLIFIER - USE IDENTIFICATION IN SYMBOL IF REQUIRED)</p> <p>BDG BRIDGING EST BOOSTER CMP COMPRESSION DC DIRECT CURRENT EXP EXPANSION LIM LIMITING MON MONITORING PGM PROGRAM PRE PRELIMINARY PWR POWER TRQ TORQUE</p>	<p>ANTENNA (3)</p> <p>GENERAL</p>  <p>DIPOLE</p>  <p>LOOP</p>  <p>COUNTERPOISE</p>  <p>ARRESTER, LIGHTNING (4)</p> <p>GENERAL</p>  <p>CARBON BLOCK</p> 	<p>ELECTROLYTIC OR ALUMINUM CELL</p>  <p>HORN GAP</p>  <p>PROTECTIVE GAP</p>  <p>SPHERE GAP</p>  <p>VALVE OR FILM ELEMENT</p>  <p>MULTIGAP</p>  <p>ATTENUATOR, FIXED (SEE PAD) (5T) (SAME SYMBOL AS VARIABLE ATTENUATOR, WITHOUT VARIABILITY)</p>
--	--	--	---

* NUMBER IN PARENTHESES INDICATES LOCATION OF SYMBOL IN MIL-STD PUBLICATION

















<p>ATTENUATOR, VARIABLE (5)</p> <p>BALANCED</p>  <p>UNBALANCED</p>  <p>AUDIBLE SIGNALING DEVICE (6)</p>  <p>BELL ELECTRICAL - RINGER TELEPHONE</p> <p>BUZZER</p>  <p>HORN, ELECTRICAL-LOUD- SPEAKER, SIREN, UNDERWATER SOUND HYDROPHONE, PROJEC- TOR OR TRANSDUCER</p> 	<p>HORN, LETTER COMBINATIONS (IF REQUIRED)</p> <p>*HN HORN, ELECTRICAL *HW HOWLER *LS LOUDSPEAKER *SH SIREN *EM ELECTROMAGNETIC WITH MOVING COIL *EMN ELECTROMAGNETIC WITH MOVING COIL AND NEUTRAL- IZING WINDING *MG MAGNETIC ARMATURE *PM PERMANENT MAGNET WITH MOVING COIL</p> <p>(IDENTIFICATION REPLACES (*) ASTERICK AND (†) DAGGER)</p> <p>SOUNDER, TELEGRAPH</p>  <p>BATTERY (7)</p> <p>GENERALIZED DIRECT CURRENT SOURCE, ONE CELL</p> 	<p>MULTICELL</p>  <p>CAPACITOR (8)</p> <p>GENERAL</p>  <p>POLARIZED</p>  <p>ADJUSTABLE OR VARIABLE</p>  <p>CONTINUOUSLY ADJUSTABLE OR VARIABLE DIFFERENTIAL</p>  <p>PHASE-SHIFTER</p> 	<p>SPLIT-STATOR</p>  <p>FEED-THROUGH</p>  <p>CELL, PHOTOSENSITIVE (SEMICONDUCTOR) (9)</p> <p>ASYMMETRICAL PHOTOCON- DUCTIVE TRANSDUCER</p>  <p>SYMMETRICAL PHOTOCON- DUCTIVE TRANSDUCER</p> 
---	--	--	--

Figure 1-34.—Electronic/logic symbols.

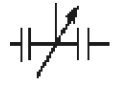
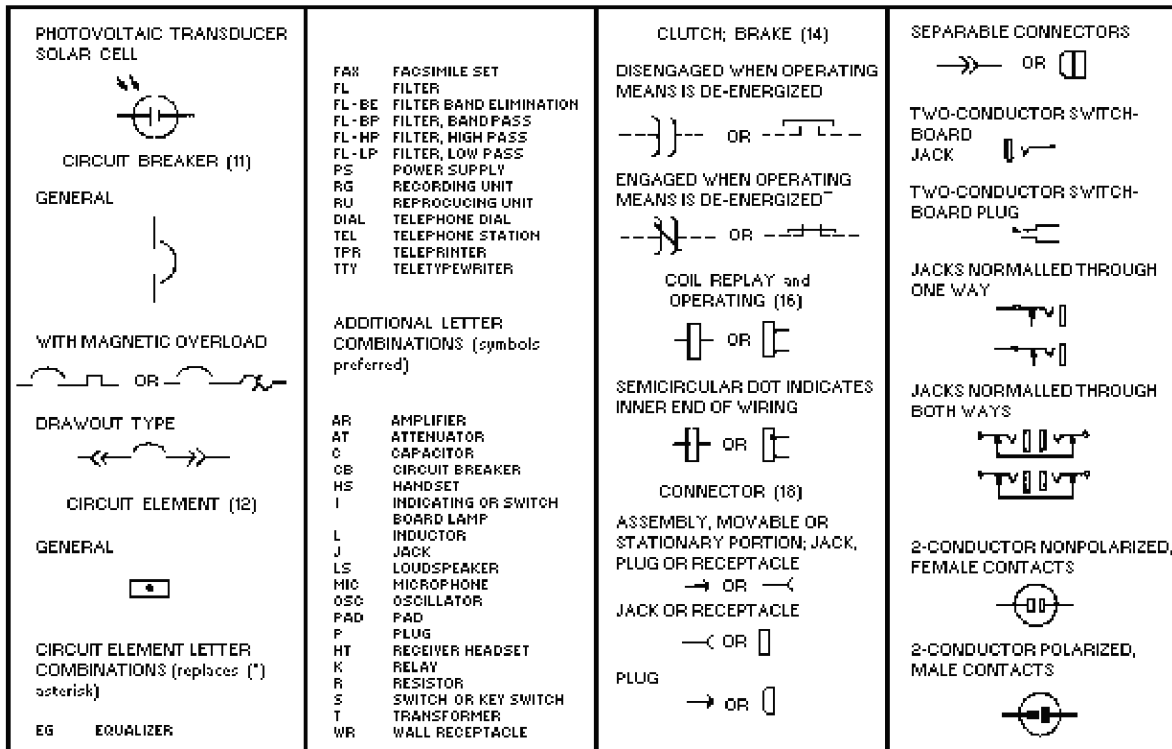

Figure 1-34.—Electronic/logic symbols.—Continued.

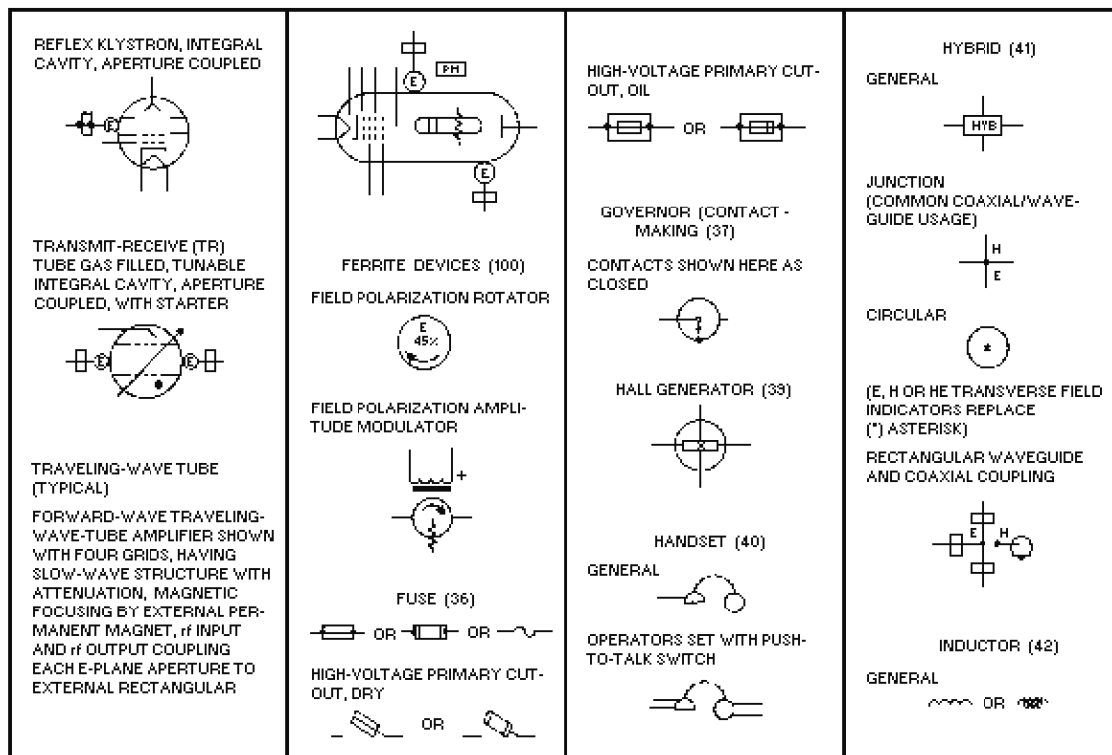
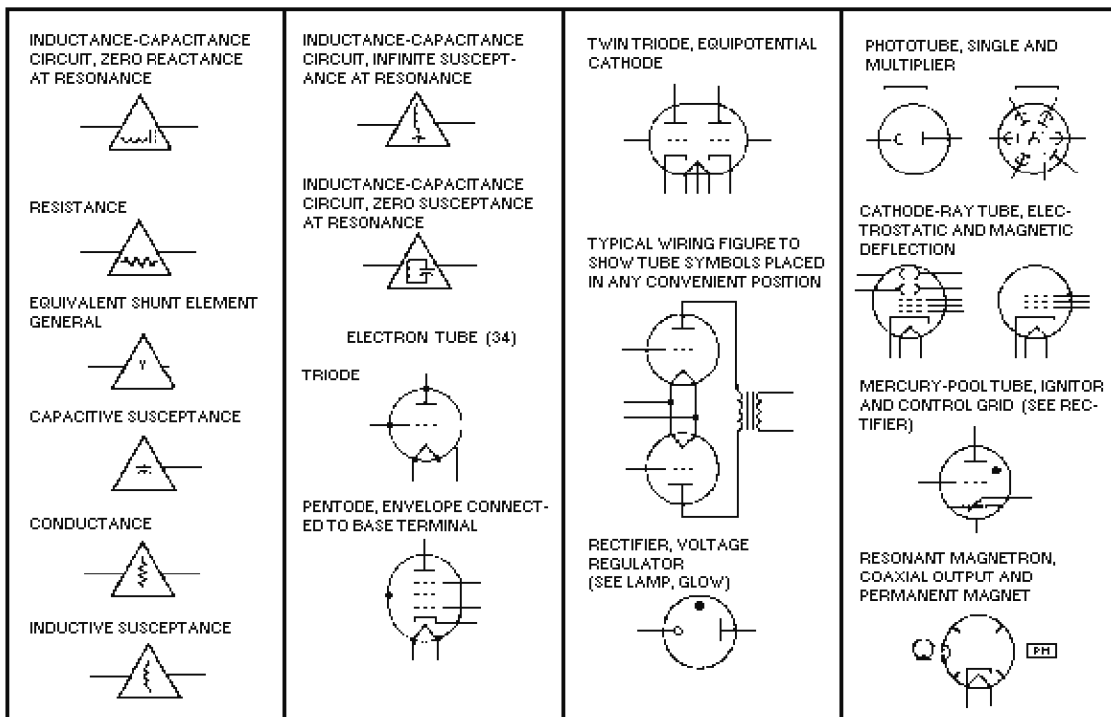

Figure 1-34.—Electronic/logic symbols.—Continued.

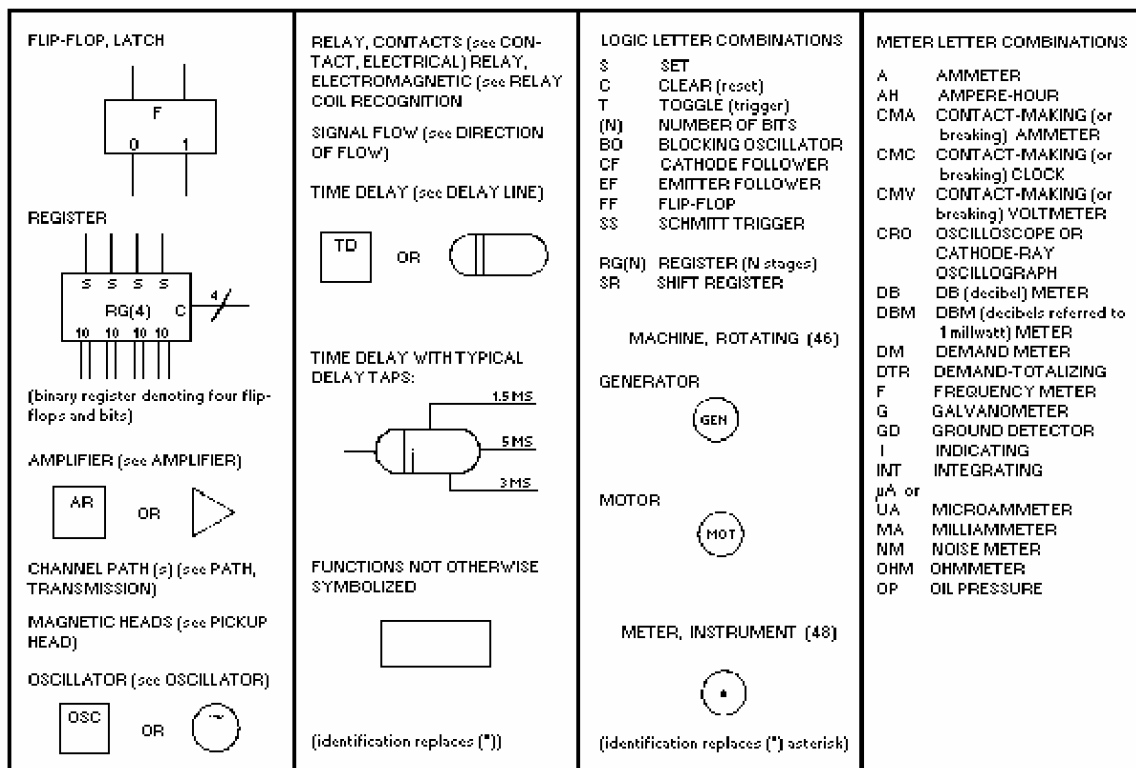
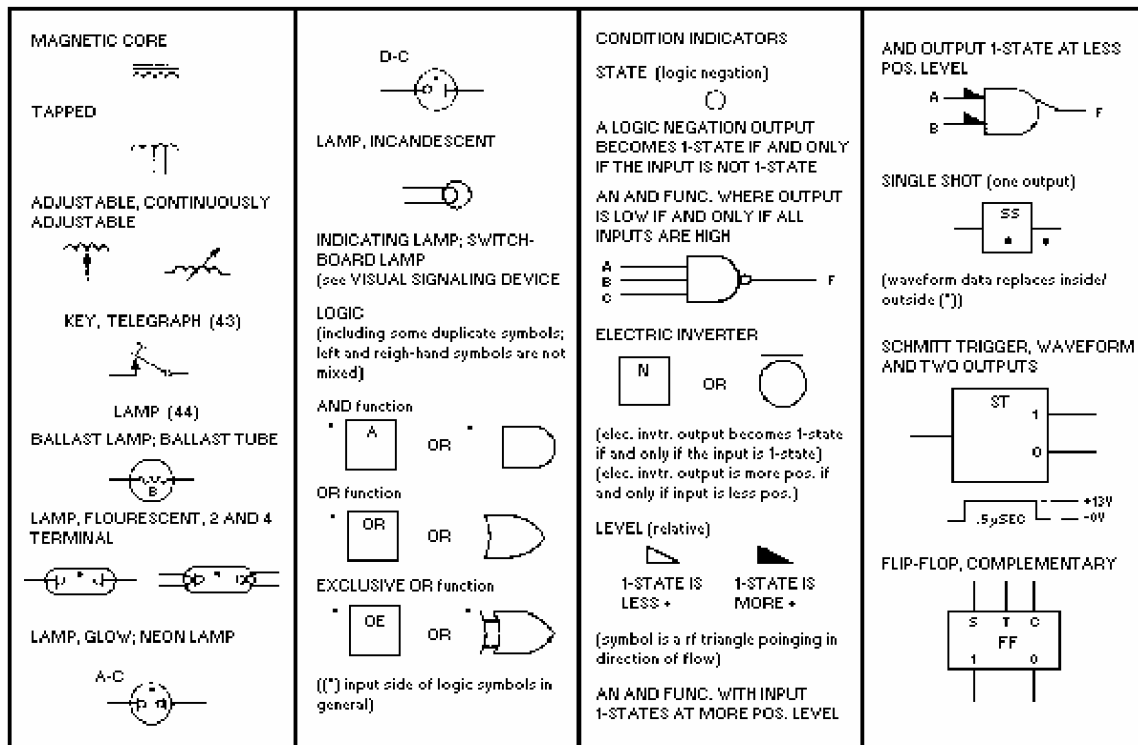

Figure 1-34.—Electronic/logic symbols.—Continued.

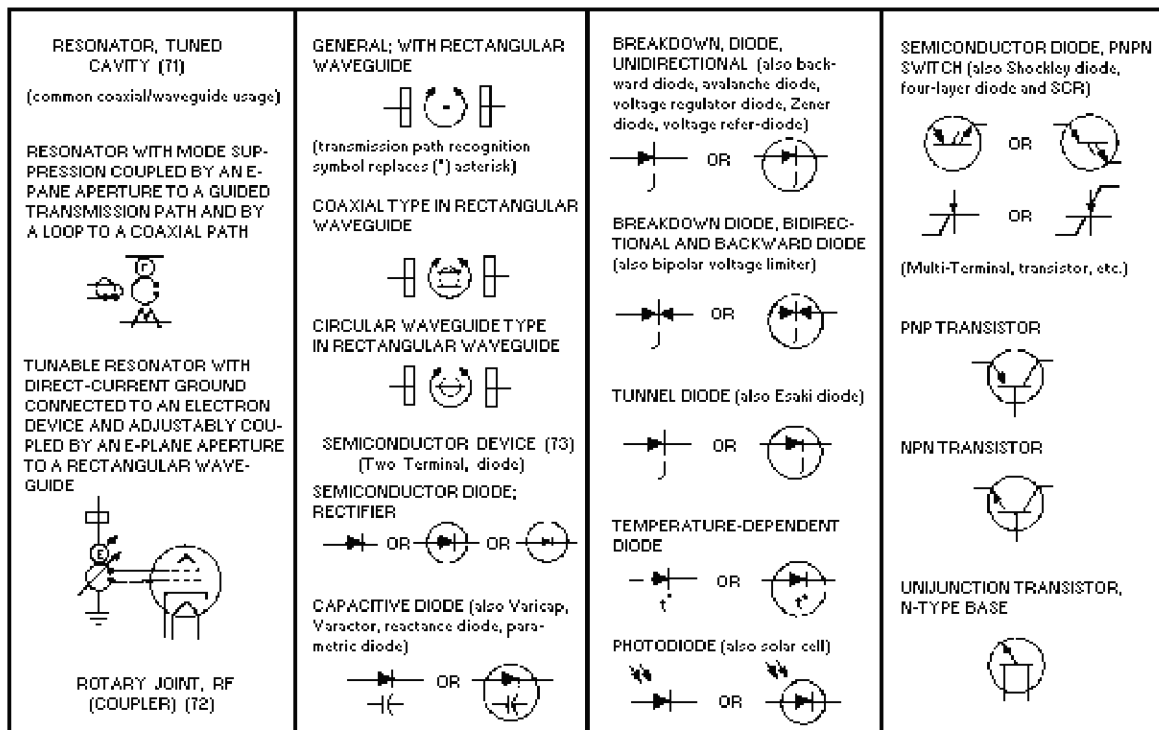
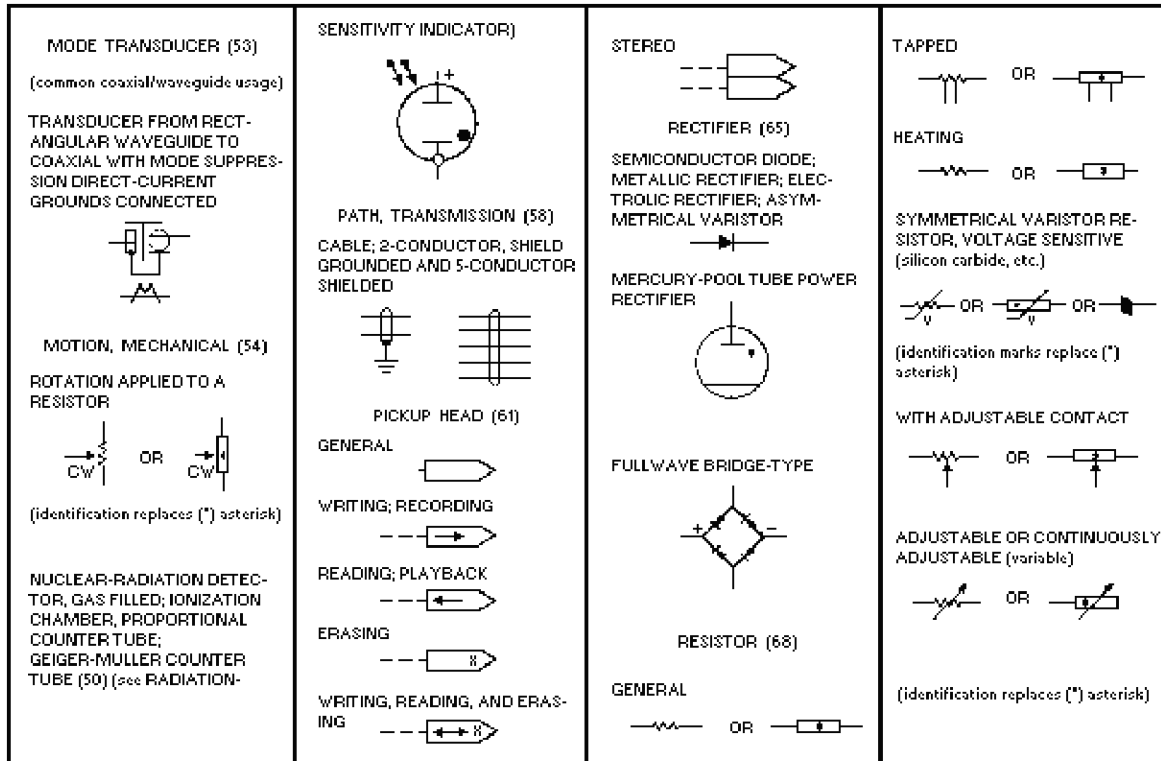

Figure 1-34.—Electronic/logic symbols.—Continued.

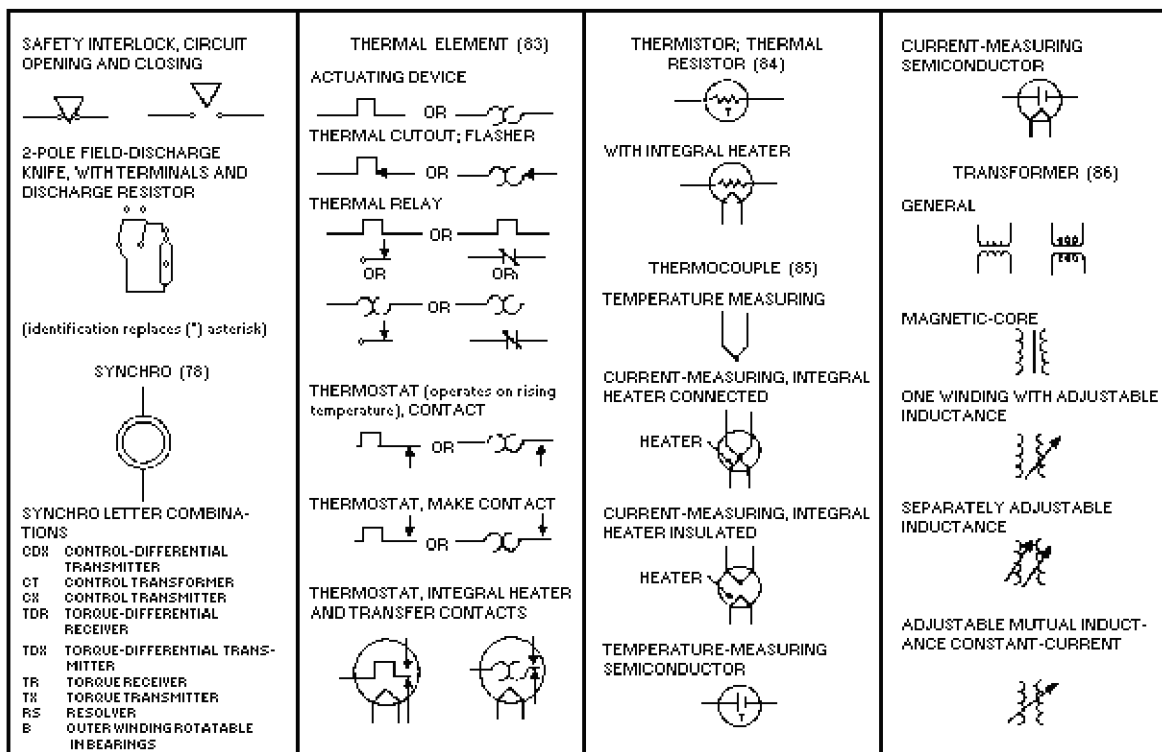
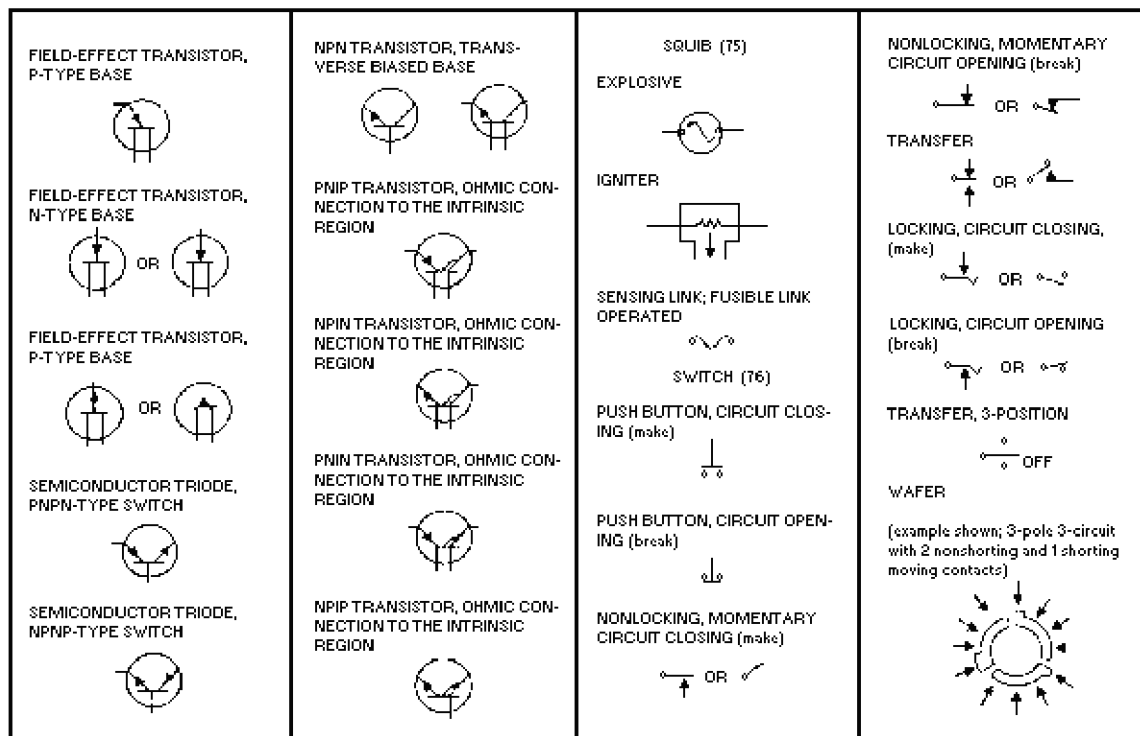

Figure 1-34.—Electronic/logic symbols.—Continued.

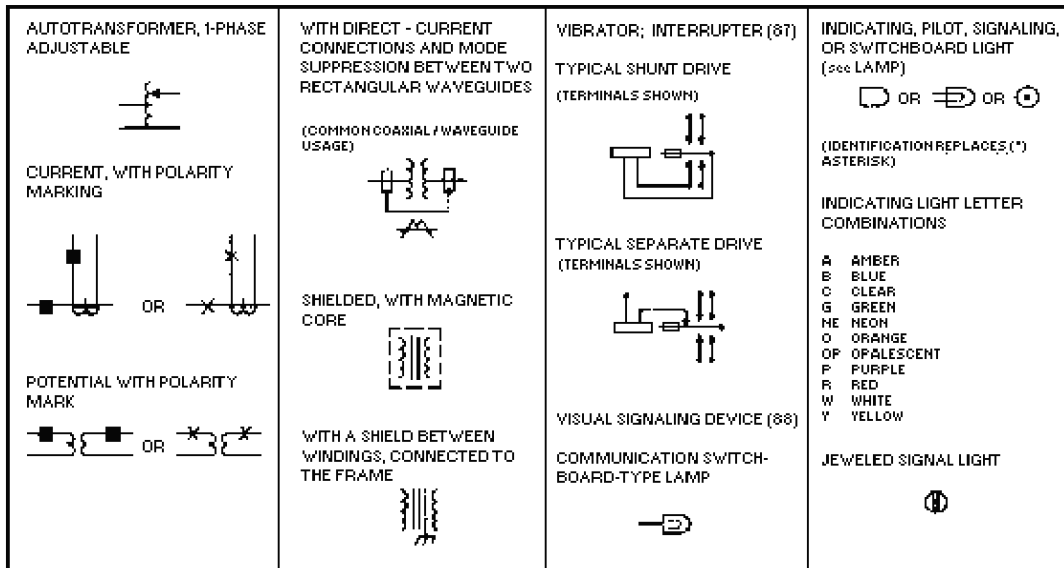

Figure 1-34.—Electronic/logic symbols.—Continued.

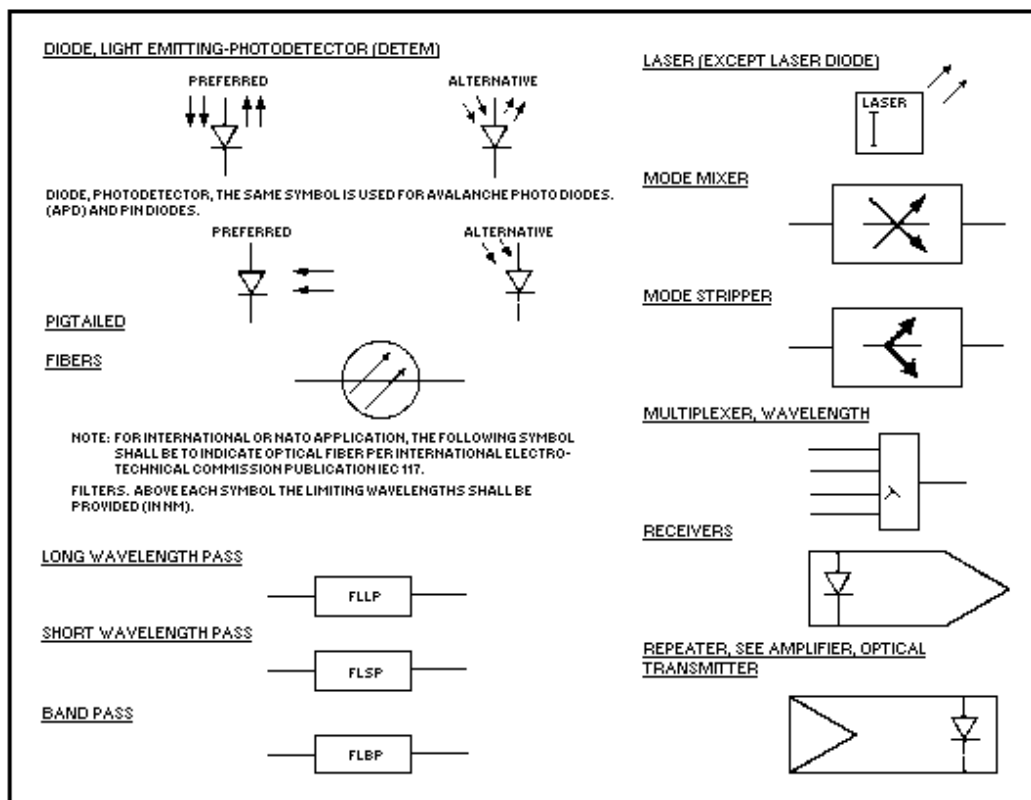
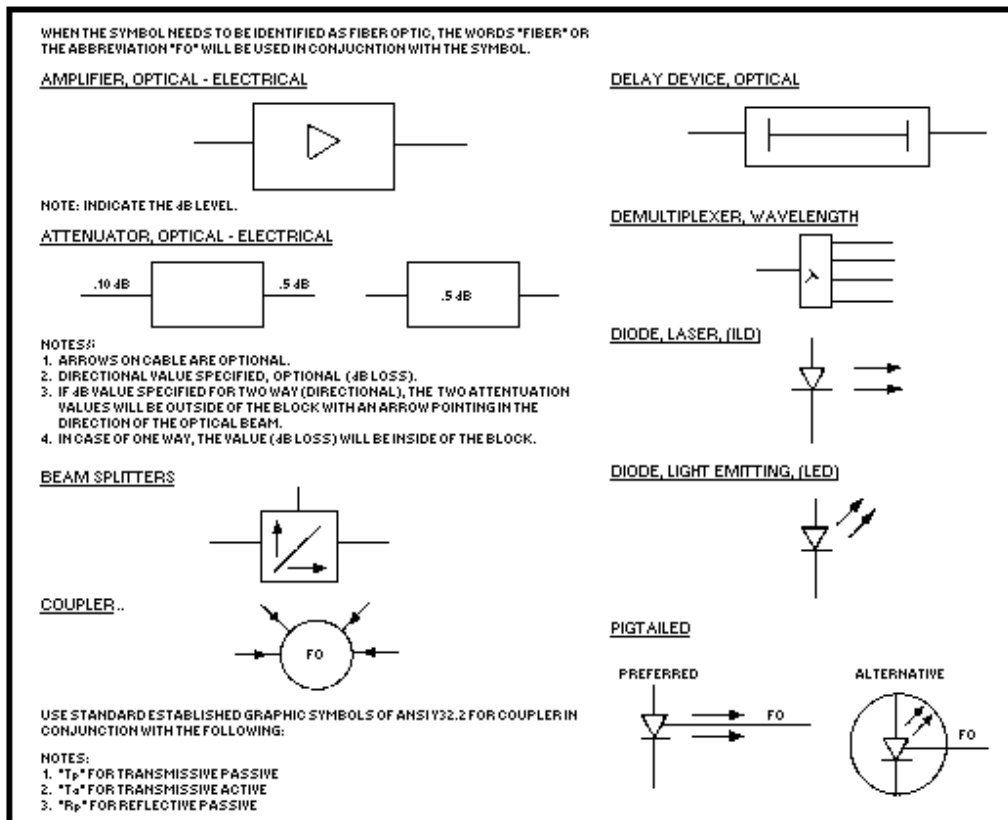
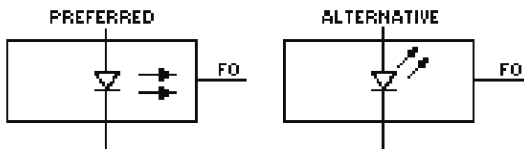

Figure 1-35.—Fiber optic symbols.

WITHOUT PIGTAIL SOURCE



CONNECTORS

RECEPTACLE-WITH OPTICAL SOURCE. FOR OPTICAL DETECTORS REVERSE DIRECTION OF ARROWS.

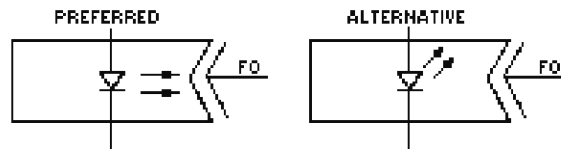

WITHOUT PIGTAIL SOURCE

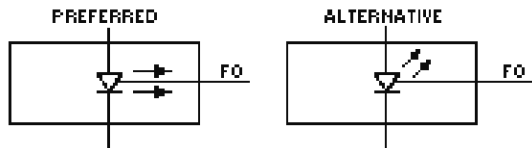

PLUG- WITH OPTICAL SOURCE. FOR OPTICAL DETECTORS REVERSE DIRECTION OF ARROWS.

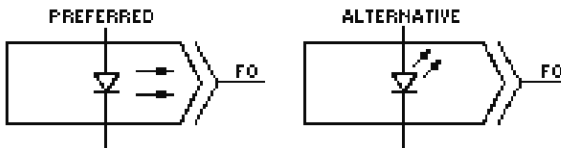

Figure 1-35.—Fiber optic symbols.—Continued.

Frequency Spectrum Designation

The complete spectrum of communications frequencies is broken down into ranges or bands. The United States practice is to designate a two- or three-letter abbreviation for the name. The practice of the International Telecommunications Union (ITU) is to designate a number. Table 1-25 shows the bands and their designators. Table 1-26 indicates the frequency spectrum broken down as to usage.

Table 1-25.—Frequency Spectrum

FREQUENCY	DESIGNATOR	IUT DESIGNATOR
BELOW 300 Hz	ELF (EXTREMELY LOW FREQUENCY)	--
300 Hz - 3 kHz	ILF (INFRA LOW FREQUENCY) SOMETIMES VF (VOICE FREQUENCY)	--
3 kHz - 30 kHz	VLF (VERY LOW FREQUENCY)	4
30 kHz - 300 kHz	LF (LOW FREQUENCY)	5
300 kHz - 3 MHz	MF (MEDIUM FREQUENCY)	6
3 MHz - 30 MHz	HF (HIGH FREQUENCY)	7
30 MHz - 300 MHz	VHF (VERY HIGH FREQUENCY)	8
300 MHz - 3 GHz	UHF (ULTRAHIGH FREQUENCY)	9
3 GHz - 30 GHz	SHF (SUPERHIGH FREQUENCY)	10
30 GHz - 300 GHz	EHF (EXTREMELY HIGH FREQUENCY)	11
300 GHz - 3 THz	THF (TREMENDOUSLY HIGH FREQUENCY)	12

Table 1-26.—Frequency Spectrum Usage

DIVISION	RANGE	USAGE
ELF	Long	Communication, Navigation, Experimental
ILF	Long	Communication, Navigation, Experimental
VLF	Long	Communication, Navigation
LF	Long Medium	Communication, Broadcasting, Navigation
MF	Medium	Communication, Broadcasting, Navigation
HF	Long	Communication, Broadcasting
VHF		Communication Television, Radar
(Lower) (Upper)	Medium Beyond horizon	
UHF	Beyond line of sight	Communication
	Line of sight	Radar
SHF	Line of sight	Radar, Doppler
EHF	Line of sight	Short-range radar
THF	Line of sight	Experimental

Television Channel Assignments

Table 1-27 lists the VHF and UHF television channel frequencies. The video carrier is 1.25 MHz above the lower channel limit. The sound carrier is .25 MHz below the upper channel limit. For example: Channel 10 sound carrier is 197 MHz, and the video carrier is 193.25 MHz.

Table 1-27.—Television Channel Frequencies

Channel	Band Limits (MHz)	Channel	Band Limits (MHz)
2	54-60	43	644-650
3	60-66	44	650-656
4	66-72	45	656-662
5	76-82	46	662-668
6	82-88	47	668-674
7	174-180	48	674-680
8	180-186	49	680-686
9	186-192	50	686-692
10	192-198	51	692-698
11	198-204	52	698-704
12	204-210	53	704-710
13	210-216	54	710-716
14	470-476	55	716-722
15	476-482	56	722-728
16	482-488	57	728-734
17	488-494	58	734-740
18	494-500	59	740-746
19	500-506	60	746-752
20	506-512	61	752-758
21	512-518	62	758-764
22	518-524	63	764-770
23	524-530	64	770-776
24	530-536	65	776-782
25	536-542	66	782-788
26	542-548	67	788-794
27	548-554	68	794-800
28	554-560	69	800-806
29	560-566	70	806-812
30	566-572	71	812-818
31	572-578	72	818-824
32	578-584	73	824-830
33	584-590	74	830-836
34	590-596	75	836-842
35	596-602	76	842-848
36	603-608	77	848-854
37	608-614	78	854-860
38	614-620	79	860-866
39	620-626	80	866-872
40	626-632	81	872-878
41	632-638	82	878-884
42	638-644	83	884-890

Joint Electronic Type Designation System (JETDS)

This system, formerly known as the Joint Army-Navy (AN) nomenclature system, was designed so that a common designation could be used for all the services' equipment. Figure 1-36 shows you how to identify equipment in the JETDS (AN) System.

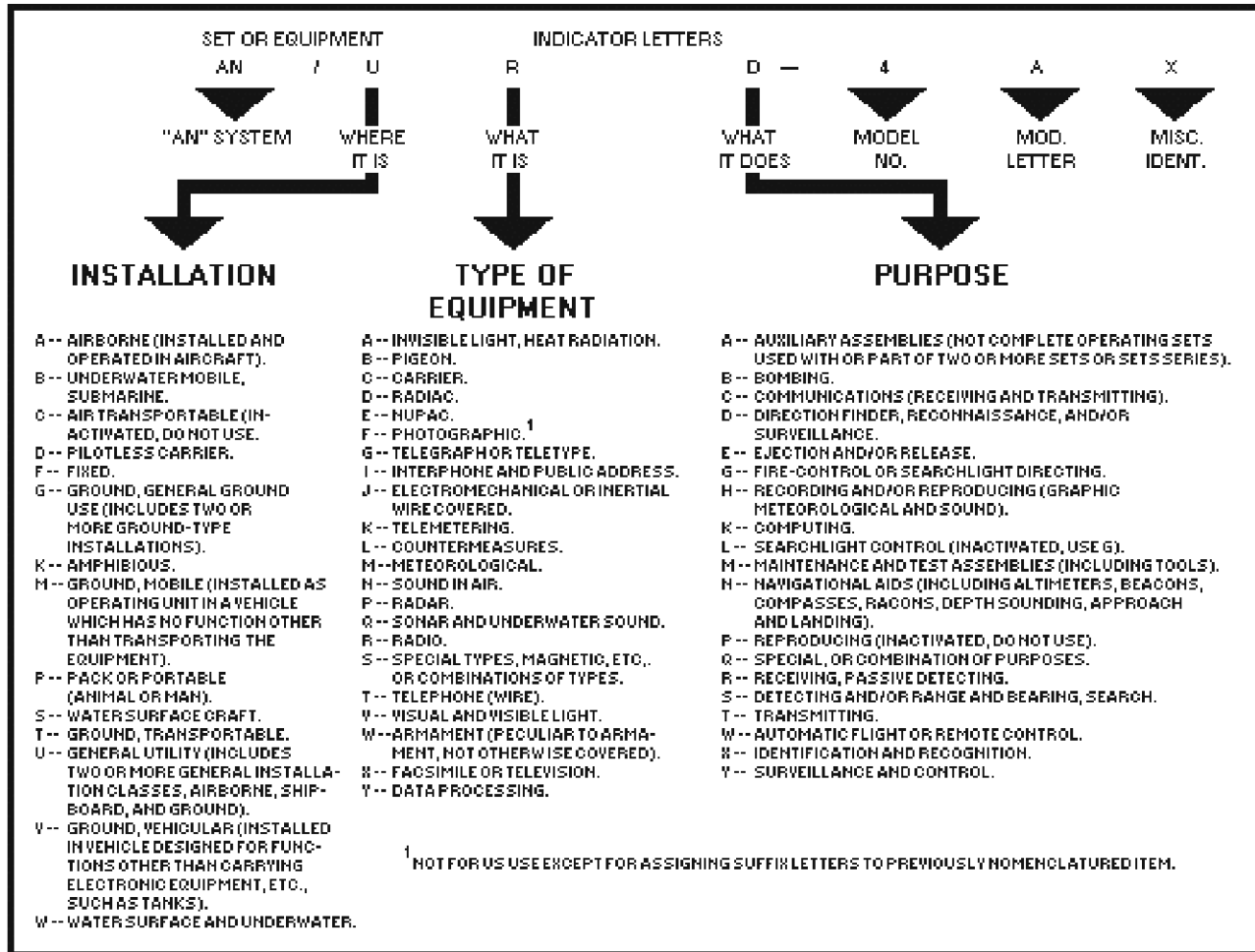

Figure 1-36.—Joint Electronics Type Designation System (AN).

Microcircuit Part Numbers.

The military designator for microcircuits is M38510. Table 1-28 shows by example how the military part number M38510/00104BCB is broken down.

Table 1-28.—Microcircuit Part Number Breakdown

1	2	3	4	5	6
M38510/	001	04	B	C	B
1.	Military Specification Designator				
2.	Detail Specification (Group of devices of similar function)				
3.	Device Type (Specific part type in group)				
4.	Device Class:				
	Class A - Manual space program				
	Class B - Avionics, space satellites				
	Class C - Prototype, noncritical ground systems				
5.	Case outline:				
	A--1/4" " 1/4" Flat Pack 14 Pin				
	B--1/4" " 1/8" Flat Pack 14 Pin				
	C--Dip 14 Pin				
	D--1/4" " 3/8" Flat Pack 14 Pin				
	E--Dip 16 Pin				
	F--1/4" " 3/8" Flat Pack 16 Pin				
	G--Can to 99 8 Pin				
	H--1/4" " 1/4" Flat Pack 10 Pin				
	I--Can to 100 10 Pin				
	J--Dip 24 Pin				
	K--3/8" " 5/8" Flat Pack 24 Pin				
	L--3/8" " 1/2" Flat Pack 24 Pin				
	X--To 5				
	Y--To 3				
	Z--1/4" " 3/8" Flat Pack 24 Pin				
6.	Lead finish:				
	A--Hot Solder				
	B--Tin Plate				
	C--Gold Plate				

Table 1-29 is a microcircuit-part-number-to-circuit-type crossover list. By using this table and table 1-28, we find our example part number M38510/00104BCB is a 5400 microcircuit type in class B, with 14 pin DIP, and tin plate leads.

Table 1-29.—Microcircuit Part Numbers to Circuit Type Crossover List

M38510/Ckt Type	M38510/Ckt Type	M38510/Ckt Type	M38510/Ckt Type	M38510/Ckt Type
00101/5430	00102/5420	00103/5410	00104/5400	00105/5404
00106/5412	00107/5401	00108/5405	00109/5403	00201/5472
00202/5473	00203/54107	00204/5476	00205/5474	00206/5470
00207/5479	00301/5440	00302/5437	00303/5438	00401/5402
00402/5423	00403/5425	00404/5427	00501/5450	00502/5451
00503/5453	00504/5454	00601/5482	00602/5483	00603/9304
00604/5480	00701/3121	00701/5486	00801/5406	00802/5416
00803/5407	00804/5417	00805/5426	00901/5495	00902/5496
00903/54164	00904/54165	00905/54194	00906/54195	00909/54198
00910/54166	01001/5442	01002/5443	01003/5444	01004/5445
01005/54145	01006/5446	01007/5447	01008/5448	01009/5449
01101/54181	01101/7181	01101/9341	01101/54182	01102/9342
01201/54121	01202/54122	01203/54123	01204/9601	01205/9602
01301/5492	01302/5493	01303/54160	01304/54163	01305/54162
01306/54161	01307/5490	01308/54192	01309/54193	01310/54196
01311/54197	01312/54177	01401/54150	01402/9312	01403/54153
01404/9309	01405/54157	01405/9322	01406/54151	01501/5475
01502/5477	01503/54116	01503/9308	01504/9314	01601/5408
01602/5409	01701/54174	01702/54175	01703/54173	01801/54170
01901/54180	01902/556	02001/54L30	02002/54L20	02003/54L10
02004/54L00	02005/54L04	02006/54L01	02006/54L03	02101/54L71
02102/54L72	02103/54L73	02104/54L78	02105/54L74	02201/54H72
02202/54H73	02203/54H74	02204/54H76	02205/54H101	02206/54H103
02301/54H30	02302/54H20	02303/54H10	02304/54H00	02305/54H04
02306/54H01	02307/54H22	02401/54H40	02501/54L90	02502/54L93
02503/54L193	02504/93L10	02505/93L16	02601/54L86	02603/7644
02701/54L02	02801/54L95	02802/54L164	02803/93L28	02804/93L00
02805/76L70	02901/54L42	02902/54L43	02903/54L44	02904/54L46
02905/54L47	02906/76L42A	02907/93L01	03001/15930	03001/930
03002/15935	03002/19535	03002/935	03002/940	03003/15936
03003/936	03004/15946	03004/946	03005/15962	03005/962
03101/15932	03102/15944	03103/15957	03104/15958	03105/15933
03201/15951	03301/15945	03302/15948	03303/15950	03304/9094
03501/MH0026	03604/54LS96	04001/54H50	04002/54H51	04003/54H53
04004/54H54	04005/54H55	04101/54L51	04102/54L54	04103/54L55
04201/54L121	04202/54L122	04301/93L18	04401/93L24	04501/93L14
04502/93L08	04601/93L09	04602/93L12	04603/93L22	05001/4011A
05002/4012A	05003/4023A	05101/4013A	05102/4027A	05103/4043A
05201/4000A	05202/4001A	05203/4002A	05204/4025A	05301/4007A
05302/4019A	05303/4030A	05401/4008A	05501/4009A	05502/4010A
05503/4049A	05504/4050A	05505/4041A	05601/4017A	05602/4018A
05603/4020A	05604/4022A	05605/4024A	05701/4006A	05702/4014A
05703/4015A	05704/4021A	05705/4031A	05706/4034A	05801/4016A
05802/4066A	05901/4028A	06001/10501	06002/10502	06003/10505
06004/10506	06005/10507	06006/10509	06101/10531	06102/10531
06103/10576	06104/10535	06201/10504	06202/10597	06301/10524
06302/10525	07001/54S00	07002/54S03	07003/54S04	07004/54S05
07005/54S10	07006/54S20	07007/54S22	07008/54S30	07009/54S133
07010/54S134	07101/54S74	07102/54S112	07103/54S113	07104/54S114
07105/54S174	07106/54S175	07201/54S40	07301/54S02	07401/54S51
07402/54S64	07403/54S65	07501/54S86	07502/54S135	07601/54S194
07602/54S195	07701/54S138	07702/54S139	07703/54S280	07801/54S181
07802/54S182	07901/54S151	07902/54S153	07903/54S157	07904/54S158
07905/54S251	07906/54S257	07907/54S258	07908/54S253	08001/54S11
08002/54S15	08003/54S08	08004/54S09	08101/54S140	08201/54S85

Table 1-29.—Microcircuit Part Numbers to Circuit Type Crossover List—Continued

M38510/Ckt Type	M38510/Ckt Type	M38510/Ckt Type	M38510/Ckt Type	M38510/Ckt Type
10101/UA741	10101/52741	10101/741	10102/52747	10102/7A747
10102/747	10103/LM101A	10103/52101A	10104/LM108A	10104/52108A
10105/LH2101A	10106/LH2108A	10107/LM118	10108/1558	10201/LM723
10201/UA723	10201/52723	10201/723	10202/LM104	10203/LM105
10301/UA710	10301/52710	10301/710	10302/UA711	10302/52711
10302/711	10303/LM106	10303/52106	10304/LM111	10304/52111
10305/LH2111	10305/LM2111	10401/55107	10402/55108	10403/55114
10403/9614	10404/55115	10404/9615	10405/55113	10406/7831
10407/7832	10501/UA733	10501/52733	10601/LM102	10602/LM110
10602/52110	10603/LH2110	10603/LM2110	10701/LM109	10701/52109
10702/LM141H-05	10703/LM141H-12	10704/LM141H-15	10705/LM141H-24	10706/LM140K-05
10707/LM140K-12	10708/LM140K-15	10709/LM140K-24	10801/3018A	10802/3045
10901/SE555	10901/555	10902/SE556	11001/LM148	11002/LM149
11003/4141	11003/4156	11004/4136	11005/LM124	11101/DG181A
11102/DG182A	11103/DG184A	11104/DG185A	11105/DG187A	11106/DG188A
11107/DG190A	11108/DG191A	11201/LM139	11202/LM193	11301/DAC-08
11302/DAC-08A	11401/LF155	11402/LF156	11403/LF157	11404/LF155A
11405/LF156A	11406/LF157A	11501/LM120H-05	11502/79M05	11502/LM120H-12
11502/79M12	11503/LM120H-15	11503/79M15	11504/LM120H-24	11504/79M24
11505/LM120K-05	11505/7905	11506/LM120K-12	11506/7912	11507/LM120K-15
11507/7915	11508/LM120K-24	11508/7924	11901/061	11902/062
11903/064	11904/LF151	11904/071	11904/771	11905/LF153
11905/072	11905/772	11906/LF147	11906/074	11906/774
15001/5485	15002/9324	15101/5413	15102/5414	15102/7414
15103/54132	15201/54154	15201/9311	15202/54155	15203/54156
15204/8250	15205/8251	15206/8252	15206/9301	15301/54125
15302/54126	15401/54120	15501/MC3101	15501/54H08	15502/MC3106
15502/54H11	15503/MC3111	15503/54H21	15601/54147	15602/54148
15603/9318	15701/9338	15801/9321	15802/9317	15901/9300
15902/9328	16001/9334	16101/5432	16201/5428	16301/54365
16302/54366	16303/54367	16304/54368	20101/MCM5303	20101/54186
20102/MCM5304	20201/IM5603A	20201/IM5603	20201/54S387	20202/IM5623
20301/AM27S10	20301/5300-1	20301/7610	20301/82S126	20301/93417
20302/AM27S11	20302/5301-1	20302/7611	20302/82S129	20302/93427
20401/IM5604	20401/5305-1	20401/7620	20401/82S130	20401/93436
20402/IM5624	20402/5306-1	20402/7621	20402/82S131	20402/93446
20501/HHX7620-8	20502/HMX7621-8	20601/HMX7640-8	20601/5352-1	20601/7642
20601/82S136	20601/93452	20602/HMX7641-8	20602/5353-1	20602/7643
20602/82S137	20602/93453	20603/7644	20701/5330	20701/7602
20701/82S23	20702/5331	20702/7603	20702/82S123	20801/5340-1
20801/7640	20801/82S140	20801/93438	20802/5341-1	20802/7641
20802/82S141	20802/93448	20803/82S115	20804/5348-1	20805/5349-1
20901/7684	20901/82S184	20902/7685	20902/82S185	20903/5380-1
20903/7680	20903/82S180	20903/93450	20904/5381-1	20904/7681
20904/82S181	20904/93451	20905/82S2708	20905/93461	20906/93460
21001/53S1680	21001/76160	21001/82S190	21001/93510	21002/53S1681
21002/76161	21002/82S191	21002/93511	22001/2708	23001/93410
23002/93411	23003/93421	23004/93L420	23101/82S10	23102/82S11
23102/93425	23103/93L415	23104/93L425	23403/54LS244	23501/TMS4060
23502/TMS4050	23503/TMS4060	23504/TMS4050	23505/MM5280	23506/MM5280
23601/MCM6605	23602/MCM6604A	23602/MKB4096	23603/MCM6605	23604/MCM6604A
23604/MKB4096	23701/AM9130CFC	23702/AM9130AFC	23703/AM9130CDM	23703/AM9130CFM
23704/AM9130ADM	23704/AM9130AFM	23705/AM91L30CF	23706/AM91L30AF	23707/AM91L30CDM
23707/AM91L30CFM	23708/AM91L30ADM	23708/AM91L30AFM	23709/AM9140CFC	23710/AM9140AFC
23711/AM9140CDM	23711/AM9140CFM	23712/AM9140ADM	23712/AM9140AFM	23713/AM91L40CFC
23714/AM91L40AFC	23715/AM91L40CDM	23715/AM91L40CFM	23716/AM91L40ADM	23716/AM91L40AFM

Table 1-29.—Microcircuit Part Numbers to Circuit Type Crossover List—Continued

M38510/Ckt Type	M38510/Ckt Type	M38510/Ckt Type	M38510/Ckt Type	M38510/Ckt Type
23901/54C929	23901/6508	23902/54C930	23902/6518	24001/2117
24002/2117	24002/4116	30001/54LS00	30002/54LS03	30003/54LS04
30004/54LS05	30005/54LS10	30006/54LS12	30007/54LS20	30008/54LS22
30009/54LS30	30101/54LS73	30102/54LS74	30103/54LS112	30104/54LS113
30105/54LS114	30106/54LS174	30107/54LS175	30108/54LS107	30109/54LS109
30110/54LS76	30201/54LS40	30202/54LS37	30203/54LS38	30204/54LS28
30301/54LS02	30302/54LS27	30303/54LS266	30401/54LS51	30401/9LS51
30402/54LS54	30402/9LS54	30501/54LS32	30502/54LS86	30601/54LS194
30602/54LS195	30603/54LS95	30605/54LS164	30606/54LS295	30607/54LS395
30608/54LS165	30609/54LS166	30701/54LS138	30702/54LS139	30703/54LS42
30704/54LS47	30801/54LS181	30901/54LS151	30902/54LS153	30903/54LS157
30904/54LS158	30905/54LS251	30906/54LS257	30907/54LS258	30908/54LS253
30909/54LS298	31001/54LS11	31002/54LS15	31003/54LS21	31004/54LS08
31005/54LS09	31101/54LS85	31201/54LS83A	31202/54LS283	31301/54LS13
31302/54LS14	31303/54LS132	31401/54LS123	31402/54LS221	31403/54LS122
31501/54LS90	31502/54LS93	31503/54LS160	31504/54LS161	31505/54LS168
31506/54LS169	31507/54LS192	31508/54LS193	31509/54LS191	31510/54LS92
31511/54LS162	31512/54LS163	31513/54LS190	31601/54LS75	31602/54LS279
31603/54LS259	31604/54LS375	31701/54LS124	31702/54LS324	31801/54LS261
31901/54LS670	32001/54LS196	32002/54LS197	32003/54LS290	32004/54LS293
32101/93415	32102/54LS26	32201/54LS365	32202/54LS366	32203/54LS367
32204/54LS368	32301/54LS125	32302/54LS126	32401/54LS240	32402/54LS241
32501/54LS273	32502/54LS373	32503/54LS374	32504/54LS377	32601/54LS155
32602/54LS156	32701/54LS390	32702/54LS393	32703/54LS490	32801/54LS242
32802/54LS243	32803/54LS245	32901/54LS280	33106/25LS174	33107/25LS175
36001/54LS148	36002/54LS348	40001/6800	42001/8080A	42101/54S412
42101/8212	42201/8224	42301/8228	44001/2901A	44101/2905
44102/2906	44103/2907	44104/2915	44105/2916	44106/2917
44201/2918	46001/9900A	47001/1802		

You can find more information on microcircuits by referring to Military Specification 38510 (MIL-M-38510), Military Standard 1562D (MIL-STD-1562D), and NEETS, Module 14, *Introduction to Microelectronics*.

Shipboard Announcing System

Table 1-30 is a breakdown list of the shipboard announcing system matched to the circuit designator.

Table 1-30.—Shipboard Announcing System

CIRCUIT	SYSTEM
*1MC	General
*2MC	Propulsion plant
*3MC	Aviators'
4MC	Damage Control
*5MC	Flight Deck
*6MC	Intership
7MC	Submarine Control
8MC	Troop administration and control
*9MC	Underwater troop communication
*10MC	Dock Control (obsolete)
*11-16MC	Turret (obsolescent)
*17MC	Double Purpose Battery (obsolescent)
18MC	Bridge
19MC	Aviation Control
*20MC	Combat Information (obsolescent)
21MC	Captain's Command
22MC	Electronic Control
23MC	Electrical control
24MC	Flag Command
25MC	Ward Room (obsolescent)
26MC	Machinery Control
27MC	Sonar and Radar Control
*28MC	Squadron (obsolescent)
*29MC	Sonar Control and Information
30MC	Special Weapons
31MC	Escape trunk
32MC	Weapons control
33MC	Gunnery Control (obsolescent)
34MC	Lifeboat (obsolescent)
35MC	Launcher Captains'
36MC	Cable Control (obsolete)
37MC	Special Navigation (obsolete)
38MC	Electrical (obsolete)
39MC	Cargo Handling
40MC	Flag Administrative
41MC	Missile Control and Announce (obsolete)
42MC	CIC Coordinating
43MC	Unassigned
44MC	Instrumentation Space
45MC	Research operations
*46MC	Aviation Ordnance and Missile Handling
47MC	Torpedo Control
48MC	Stores conveyor (obsolescent)
49MC	Unassigned
50MC	Integrated operational intelligence center
51MC	Aircraft Maintenance and handling control
52MC	Unassigned

Table 1-30.—Shipboard Announcing System—Continued

CIRCUIT	SYSTEM
53MC	Ship Administrative
54MC	Repair officer's control
55MC	Sonar Service
56MC	Unassigned
57MC	Unassigned
58MC	Hanger Deck Damage Control
59MC	SAMID Alert

*- Central amplifier systems

Shipboard Alarm and Warning Systems

Table 1-31 is a breakdown list of the shipboard alarm and warning systems matched to a circuit designator.

Table 1-31.—Shipboard Alarm and Warning System

CIRCUIT	SYSTEM
BZ	Brig cell door alarm and lock operating
BW	Catapult Bridle Arresterman safety Ind.
CX	Bacteriological Lab. & Pharmacy Comb. Refer Failure
DL	Secure communications space door position alarm
DW	Wrong direction alarm
EA	Reactor compartment or fireroom emergency alarm
1EC	Lubricating oil low pressure alarm-propulsion machinery
2EC	Lubricating oil low pressure alarm-auxiliary machinery
1ED	Generator high temperature alarm
2ED	Oxygen-nitrogen generator plant low temperature alarm
EF	Generator bearing high temperature alarm
EG	Propeller pitch control, hydraulic oil system low pressure alarm
EH	Gas turbine exhaust high temperature alarm
EJ	Feed pressure alarm
1EK	Pneumatic control air pressure alarm
3EK	Catapult steam cutoff and alarm
EL	Radar cooling lines temperature and flow alarm
EP	Gas turbine lubricating oil high temperature alarm
1EQ	Desuperheater high temperature alarm
2EQ	Catapult steam trough high temperature alarm
3ES	Reactor fill alarm
ET	Boiler temperature alarm
EV	Toxic vapor detector alarm
1EW	Propulsion engines circulating water high temperature
2EW	Auxiliary machinery circulating water high temperature
EZ	Condenser vacuum alarm
F	High temperature alarm
4F	Combustion gas and smoke detector
9F	High temperature alarm system-ASROC launcher
11F	FBM storage area temperature and humidity alarm
12F	Gyro ovens temperature and power failure alarm
FD	Flooding alarm
FH	Sprinkling alarm
FR	Carbon dioxide release alarm
FS	Flight Deck Readylight Signal system
FZ	Security alarm (CLASSIFIED)
4FZ	Torpedo alarm (CLASSIFIED)
HF	Air flow indicator and alarm
LB	Steering Emergency Signal system
LS	Submersible steering gear alarm
MG	Gas turbine overspeed alarm
NE	Nuclear facilities air particle detector alarm
NH	Navigation Horn Operating System

Table 1-31.—Shipboard Alarm and Warning System—Continued

CIRCUIT	SYSTEM
QA	Air lock warning
QD	Air filter and flame arrester pressure differential alarm, or gasoline compartment exhaust blower alarm
QX	Oxygen-nitrogen plant ventilation exhaust alarm
RA	Turret emergency alarm
RD	Safety observer warning
RW	Rocket and torpedo warning
4SN	Scavenging air blower high temperature alarm
SP	Shaft position alarm
TD	Liquid level alarm
1TD	Boiler water level alarm
2TD	Deaerating feed tank water level alarm
5TD	Reactor compartment bilge tank alarm
6TD	Primary shield tank, expansion tank level alarm
7TD	Reactor plant fresh water cooling expansion tank level alarm
8TD	Reactor secondary shield tank level alarm
9TD	Lubricating oil sump tank liquid level alarm
11TD	Induction air sump alarm
12TD	Diesel oil sea water compensating system tank liquid level alarm
14TD	Auxiliary fresh water tank low level alarm
16TD	Pure water storage tank low level alarm
17TD	Reserve feed tank alarm
18TD	Effluent tanks and contaminated laundry tank high level alarm
19TD	Sea water expansion tank low level alarm
20TD	Gasoline drain tank high level alarm
21TD	Moisture separator drain cooler high level alarm
24TD	Reactor plant on board discharge tank level alarm
25TD	Crossover drains high level alarm
29TD	Sonar dome fill tank low level alarm
30TD	JP-5 fuel drain tank high level alarm
TW	Train Warning system
W	Whistle Operating System

Sound-Powered Telephone Circuits

Table 1-32 is a breakdown list of the sound-powered telephone circuits matched to circuit designators.

Table 1-32.—Sound-Powered Telephone Circuits

CIRCUIT	PRIMARY CIRCUITS TITLE
JA	Captain's battle circuit
JC	Weapons control circuit
10JC	Missile battery control circuit
JD	Target detectors circuit
JF	Flag officer's circuit
1JG	Aircraft control circuit
2JG	Aircraft information circuit
2JG1	Aircraft strike coordination circuit
2JG2	Aircraft strike requirement and reporting circuit
2JG3	Aircraft information circuit CATTTC direct line
3JG	Aircraft service circuit
4JG1	Aviation fuel and vehicular control circuit
4JG2	Aviation fueling circuit forward
4JG3	Aviation fueling circuit aft
5JG1	Aviation ordnance circuit
5JG2	Aviation missile circuit
6JG	Arresting gear and barricade control circuit
9JG	Aircraft handling circuit
10JG	Airborne aircraft information circuit
11JG	Optical landing system control circuit
JH	Switchboard cross connecting circuit
JL	Lookouts circuit
JK	Double purpose fuse circuit
JM	Mine control circuit
JN	Illumination control circuit
JO	Switchboard operators circuit
2JP	Dual purpose battery control circuit
4JP	Heavy machine gun control circuit
5JP	Light machine gun control circuit
6JP	Torpedo control circuit
8JP	ASW weapon control circuit
9JP	Rocket battery control circuit
10JP	Guided missile launcher control circuit
3JV	Engineer's circuit (boiler)
4JV	Engineer's circuit (fuel and stability)
5JV	Engineer's circuit (electrical)
6JV	Ballast control circuit
11JV	Waste control circuit
JW	Ship control bearing circuit
JX	Radio and signals circuit
2JZ	Damage and stability control
3JZ	Main deck repair circuit

Table 1-32.—Sound-Powered Telephone Circuits—Continued

CIRCUIT	PRIMARY CIRCUITS TITLE
4JZ	Forward repair circuit
5JZ	After repair circuit
6JZ	Midships repair circuit
7JZ	Engineer's repair circuit
8JZ	Flight deck repair circuit
9JZ	Magazine sprinkling and ordnance repair circuit forward
10JZ	Magazine sprinkling and ordnance repair circuit aft
11JZ	Gallery deck and island repair circuit

Table 1-32.—Sound-Powered Telephone Circuits

CIRCUIT	PRIMARY CIRCUITS TITLE
	Auxiliary Circuits
XJA	Auxiliary captain's battle circuit
X1JG	Auxiliary aircraft control circuit
X1JV	Auxiliary maneuvering and docking circuit
XJX	Auxiliary radio and signals circuit
X2JZ	Auxiliary damage and stability control circuit
	Supplementary Circuits
X1J	Ship administration circuit
X2J	Leadsman and anchor control circuit
X3J	Engineer watch officer's circuit
X4J	Degaussing control circuit
X5J	Machinery room control circuit
X6J1	Electronic service circuit
X6J7	ECM service circuit
X6J11-14	NTDS service circuits
X7J	Radio-sonde information circuit
10JP1	Starboard launcher circuit
10JP2	Port launcher circuit
11JP	FBM checkout and control circuit
JQ	Double purpose sight setters circuit
JR	Debarcation control circuit
JS	Plotters' transfer switchboard circuit
1JS	CIC information circuit
2JS	NTDS coordinating circuit No. 1
3JS	NTDS coordinating circuit No. 2
20JS1	Evaluated radar information circuit
20JS2	Evaluator's circuit
20JS3	Radar control officer's circuit

Table 1-32.—Sound-Powered Telephone Circuits—Continued

CIRCUIT	PRIMARY CIRCUITS TITLE
	SUPPLEMENTARY CIRCUITS (CONTINUED)
20JS4	Weapons liaison officer's circuit
21JS	Surface search radar circuit
22JS	Long range air search radar circuit
23JS	Medium range air search radar circuit
24JS	Range height finder radar circuit
25JS	AEW radar circuit
26JS	Radar information circuit
31JS	Track analyzer No. 1 air radar information check
32JS	Track analyzer No. 2 air radar information check
33JS	Track analyzer No. 3 air radar information check
34JS	Track analyzer No. 4 air radar information check
35JS	Raid air radar information circuit
36JS	Combat air patrol air radar information circuit
61JS	Sonar information circuit
80JS	ECM plotters' circuit
81JS	ECM information circuit
82JS	Supplementary radio circuit
JT	Target designation control circuit
1JV	Maneuvering and docking circuit
2JV	Engineers' circuit (engines)
X8J	Replenishment-at-sea circuit
X9J	Radar trainer circuit
X10J	Cargo transfer control circuit
X10J1	Cargo transfer circuit-Lower decks
X10J10	Cargo transfer circuit-Upper decks
X11J	Captain's and admiral's cruising circuit
X12J	Capstan control circuits
X13J	Aircraft crane control circuits
X14J	Missile handling and nuclear trunk crane circuit
X15J	SINS information circuit
X16J	Aircraft elevator circuit
X17J	5-inch ammunition hoist circuit
X18J	Machine gun ammunition hoist circuits
X19J	Missile component elevator circuit
X20J	Weapons elevator circuits
X21J	Catapult circuit
X22J	Catapult steam control circuit
X23J	Stores conveyor circuit
X24J	Cargo elevator circuit
X25J	Sonar service circuit
X26J	Jet engine test circuit
X28J	Dumbwaiter circuit

Table 1-32.—Sound-Powered Telephone Circuits—Continued

CIRCUIT	PRIMARY CIRCUITS TITLE
	SUPPLEMENTARY CIRCUITS (CONTINUED)
X29J	Timing and recording circuit
X34J	Alignment cart service circuit
X40J	Casualty communication circuit
X41J	Special weapons shop service circuit
X42J	Missile assembly and handling circuit
X43J	Weapons system service circuit
X44J	ASROC service circuit
X45J	Special weapons security circuit
X50J	Fog foam circuit
X61J	Nuclear support facilities operations and handling circuit

Screw, Drill, and Tap Data

Table 1-33 contains machine screw information, such as threads per inch, drill, and tap information.

Table 1-33.—Screw, Drill, and Tap Data

MACHINE SCREW		THREADS PER INCH		CLEARANCE DRILL		TAP DRILL	
NO.	DIA.	COARSE	FINE	NO.	DIA.	NO.	DIA.
0	0.060		80	52	0.063	56	0.046
1	0.073	64	72	47	0.078	53	0.059
2	0.086	56	64	42	0.093	50	0.079
		48				47	0.079
3	0.099			37	0.104		
			56			45	0.082
		40				43	0.089
4	0.112			31	0.120		
			48			42	0.093
		40				38	0.101
5	0.125			29	0.136		
			44			37	0.104
		32				36	0.107
6	0.138			27	0.144		
			40			33	0.113
		32				29	0.136
8	0.164			18	0.169		
			36			29	0.136
		24				25	0.149
10	0.190			9	.196		
			32			21	0.159
		24				16	0.177
12	0.216				.228		
			28			14	0.182
		20				7	.201
1/4	0.250				17/64		
			28			3	.213

*Size for use in hand-tapping brass or soft steel; for copper, aluminum, bakelite, or similar material use one size larger.

Logarithms, Common

Table 1-34 is a seven-place table of logarithms.

Table 1-34.—Common Logarithms

N	0	1	2	3	4	5	6	7	8	9
10	0000000	0043214	0086002	0128372	0170333	0211893	0253059	0293838	0334238	0374265
11	0413927	0453230	0492180	0530784	0569049	0606978	0644580	0681859	0718820	0755470
12	0791812	0327854	0863598	0899051	0934217	0969100	1003705	1038037	1072100	1105897
13	1139434	1172713	1205739	1238516	1271048	1303338	1335389	1367206	1398791	1430148
14	1461280	1492191	1522883	1553360	1583625	1613680	1643529	1673173	1702617	1731863
15	1760913	1789769	1818436	1846914	1875207	1903317	1931246	1958997	1986571	2013971
16	2041200	2068259	2095150	2121876	2148438	2174839	2201081	2227165	2253093	2278867
17	2304489	2329961	2355284	2380461	2405492	2430380	2455127	2479733	2504200	2528530
18	2552725	2576786	2600714	2624511	2648178	2671717	2695129	2718416	2741578	2764618
19	2787536	2810334	2833012	2855573	2878017	2900346	2922561	2944662	2966652	2988531
20	3010300	3031961	3053514	3074960	3096302	3117539	3138672	3159703	3180633	3201463
21	3222193	3242825	3263359	3283796	3304138	3324385	3324538	3364597	3384565	3404441
22	3424227	3443923	3463530	3483049	3502480	3521825	3541084	3560259	3579348	3598355
23	3617278	3636120	3654880	3673559	3692159	3710679	3729120	3747483	3765770	3783979
24	3802112	3820170	3838154	3856063	3873898	3891661	3909351	3926970	3944517	3961993
25	3979400	3996737	4014005	4031205	4048337	4065402	4082400	4099331	4116197	4132998
26	4149733	4166405	4183013	4199557	4216039	4232459	4248816	4265113	4281348	4297523
27	4313638	4329693	4345689	4361626	4377506	4393327	4409091	4424798	4440448	4456042
28	4471580	4487063	4502491	4517864	4533183	4548449	4563660	4578819	4593925	4608978
29	4623980	4638930	4653829	4668676	4683473	4698220	4712917	4727564	4742163	4756712
30	4771213	4785665	4800069	4814426	4828736	4842998	4857214	4871384	4885507	4899585
31	4913617	4927604	4941546	4955443	4969296	4983106	4996871	5010593	5024271	5037907
32	5051500	5065050	5078559	5092025	5105450	5118834	5132176	5145478	5158738	5171959
33	5185139	5198280	5211381	5224442	5237465	5250448	5263393	5276299	5289167	5301997
34	5314789	5327544	5340261	5352941	5365584	5378191	5390761	5403295	5415792	5428254
35	5440680	5453071	5465427	5477747	5490033	5502284	5514500	5526682	5538830	5550944
36	5563025	5575072	5587086	5599066	5611014	5622929	5634811	5646661	5658478	5670264
37	5682017	5693739	5705429	5717088	5728716	5740313	5751878	5763414	5774918	5786392
38	5797836	5809250	5820634	5831988	5843312	5854607	5865873	5877110	5888317	5899496
39	5910646	5921768	5932861	5943926	5954962	5965971	5976952	5987905	5998831	6009729
40	6020600	6031444	6042261	6053050	6063814	6074550	6085260	6095944	6106602	6117233
41	6127839	6138418	6148972	6159501	6170003	6180481	6190933	6201361	6211763	6222140
42	6232493	6242821	6253125	6263404	6273659	6283889	6294096	6304279	6314438	6324573
43	6334685	6344773	6354837	6364879	6374897	6384893	6394865	6404814	6414741	6424645
44	6434527	6444386	6454223	6464037	6473830	6483600	6493349	6503075	6512780	6522463
45	6532125	6541765	6551384	6560982	6570559	6580114	6589648	6599162	6608655	6618127
46	6627578	6637099	6646420	6655810	6665180	6674530	6683859	6693169	6702459	6711728
47	6720979	6730209	6739420	6748611	6757783	6766936	6776070	6785184	6794279	6803355
48	6812412	6821451	6830470	6839471	6848454	6857417	6866363	6875290	6884198	6893089
49	6901961	6910815	6919651	6928469	6937269	6946052	6954817	6963564	6972293	6981005
50	6989700	6998377	7007037	7015680	7024305	7032914	7041505	7050080	7058637	7067178
51	7075702	7084209	7092700	7101174	7109631	7118072	7126497	7134905	7143298	7151674
52	7160033	7168377	7176705	7185017	7193313	7201593	7209857	7218106	7226339	7234557
53	7242759	7250945	7259116	7267272	7275413	7283538	7291648	7299743	7307823	7315888
54	7323938	7331973	7339993	7347998	7355989	7363965	7371926	7379873	7387806	7395723

Table 1-34.—Common Logarithms—Continued

N	0	1	2	3	4	5	6	7	8	9
55	7403627	7411516	7419391	7427251	7435098	7442930	7450748	7458552	7466342	7474118
56	7481980	7489629	7497363	7505084	7512791	7520484	7528164	7535831	7543483	7551123
57	7338749	7566361	7573960	7581546	7589119	7596678	7604225	7611758	7619278	7626786
58	7634280	7641761	7649230	7656686	7664128	7671559	7678976	7686381	7693773	7701153
59	7708520	7715875	7723217	7730547	7737864	7745170	7752463	7759743	7767012	7774268
60	7781513	7788745	7795965	7803173	7810369	7817554	7824726	7831887	7839036	7846173
61	7853298	7860412	7867514	7874605	7881684	7888751	7895807	7902852	7909885	7916906
62	7923917	7930916	7937904	7944880	7951846	7958800	7965743	7972675	7979596	7986506
63	7993405	8000294	8007171	8014037	8020893	8027737	8034571	8041394	8048207	8055009
64	8061800	8068580	8075350	8082110	8088859	8095597	8102325	8109043	8115750	8122447
65	8129134	8135810	8142476	8149132	8155777	8162413	8169038	8175654	8182259	8188854
66	8195439	8202015	8208580	8215135	8221681	8228216	8234742	8241258	8247765	8254261
67	8260748	8267225	8273693	8280151	8286599	8293038	8299467	8305887	8312297	8318698
68	8325089	8331471	8337844	8344207	8350561	8256906	8363241	8369567	8375884	8382192
69	8388491	8394780	8401061	8407332	8413505	8419848	8426092	8432328	8438554	8444772
70	8450980	8457180	8463371	8469553	8475727	8481891	8488047	8494194	8500333	8506462
71	8512583	8518696	8524800	8530895	8536982	8543060	8549130	8555192	8561244	8567289
72	8573325	8579353	8585372	8591383	8597386	8603380	8609366	8615344	8621314	8627275
73	8633229	8639174	8645111	8651040	8656961	8662873	8668778	8674675	8680564	8686444
74	8692317	8698182	8704039	8709888	8715729	8721563	8727388	8733206	8739016	8744818
75	8750613	8756399	8762178	8768950	8773713	8779470	8785218	8790959	8796692	8802418
76	8808136	8813847	8819550	8825245	8830934	8836614	8842288	8847954	8853612	8859263
77	8864907	8870544	8876173	8881795	8887410	8893017	8898617	8904210	8909796	8915375
78	8920946	8926510	8932068	8937618	8943161	8948697	8954225	8959747	8965262	8970770
79	8976271	8981765	8987252	8992732	8998205	9003671	9009131	9014583	9020029	9025468
80	9030900	9036325	9041744	9047155	9052560	9057959	9063350	9068735	9074114	9079485
81	9084850	9090209	9095560	9100905	9106244	9111576	9116902	9122221	9127533	9132839
82	9138139	9143432	9148718	9153998	9159272	9164539	9169800	9175055	9180303	9185545
83	9190781	9196010	9201233	9206450	9211661	9216865	9222063	9227255	9232440	9237620
84	9242793	9247960	9253121	9258276	9263424	9268567	9273704	9278834	9283959	9289077
85	9294189	9299296	9304396	9309490	9314579	9319661	9324738	9329808	9334873	9339932
86	9344985	9350032	9355073	9360108	9365137	9370161	9375179	9380191	9385197	9390198
87	9395193	9400182	9405165	9410142	9415114	9420081	9425041	9429996	9434945	9439889
88	9444827	9449759	9454686	9459607	9464523	9469433	9474337	9479236	9484130	9489018
89	9493900	9498777	9503649	9508515	9513375	9518230	9523080	9527924	9532763	9537597
90	9542425	9547248	9552065	9556878	9561684	9566486	9571282	9576073	9580858	9585639
91	9590414	9595184	9599948	9604708	9609462	9614211	9618955	9623693	9628427	9633155
92	9637878	9642596	9647309	9652017	9656720	9661417	9666110	9670797	9675480	9680157
93	9684829	9689497	9694159	9698816	9703469	9708116	9712758	9717396	9722028	9726656
94	9731279	9735896	9740509	9745117	9749720	9754318	9758911	9763500	9768083	9772662
95	9777236	9781805	9786369	9790929	9795484	9800034	9804579	9809119	9813655	9818186
96	9822712	9827234	9831751	9836263	9840770	9845273	9849771	9854265	9858754	9863238
97	9867717	9872192	9876663	9881128	9885590	9890046	9894498	9898946	9903389	9907827
98	9912261	9916690	9921115	9925535	9929951	9934362	9938769	9943172	9947569	9951963
99	9956352	9960737	9965117	9969492	9973864	9978231	9982593	9986952	9991305	9995655

Trigonometric Functions

Table 1-35 is a table of trigonometric functions.

Table 1-35. Trigonometric Functions

deg	sin	cos	tan	cot	deg	sin	cos	tan	cot	deg	sin	cos	tan	cot
0.0	.00000	1.0000	.00000		90.0	4.0	.06976	0.9976	.06993	14.301	86.0			
.1	.00175	1.0000	.00175	573.0	.9	.1	.07150	.9974	.07168	13.951	.9			
.2	.00349	1.0000	.00349	286.5	.8	.2	.07324	.9973	.07344	13.617	.8			
.3	.00524	1.0000	.00524	191.0	.7	.3	.07498	.9972	.17519	13.300	.7			
.4	.00698	1.0000	.00698	143.24	.6	.4	.07672	.9971	.07695	12.996	.6			
.5	.00873	1.0000	.00873	114.59	.5	.5	.07846	.9969	.07870	12.706	.5			
.6	.01047	0.9999	.10147	95.49	.4	.6	.08020	.9968	.08046	12.429	.4			
.7	.01222	.9999	.01222	81.85	.3	.7	.08194	.9966	.08221	12.163	.3			
.8	.01396	.9999	.01396	71.62	.2	.8	.08368	.9965	.08397	11.909	.2			
.9	.01571	.9999	.01571	63.66	.1	.9	.08542	.9963	.08573	11.664	.1			
1.0	.01745	0.9998	.01746	57.20	89.0	5.0	.08716	0.9962	.08749	11.430	85.0			
.1	.01920	.9998	.01920	52.08	.9	.1	.08889	.9960	.089215	11.205	.9			
.2	.02094	.9998	.02095	47.74	.8	.2	.09063	.9959	.09101	10.988	.8			
.3	.02269	.9997	.02269	44.07	.7	.3	.09237	.9957	.09277	10.780	.7			
.4	.02443	.9997	.02444	40.92	.6	.4	.09411	.9956	.09453	10.579	.6			
.5	.02618	.9997	.02619	38.19	.5	.5	.09585	.9954	.09629	10.385	.5			
.6	.02792	.9996	.02793	35.80	.4	.6	.09758	.9952	.09805	10.199	.4			
.7	.02967	.9996	.02968	33.69	.4	.7	.09932	.9951	.09981	10.019	.3			
.8	.03141	.9995	.03143	31.82	.2	.8	.10106	.9949	.10158	9.845	.2			
.9	.03316	.9995	.03317	30.14	.1	.9	.10279	.9947	.10334	9.677	.1			
2.0	.03490	0.9994	.03492	28.64	88.0	6.0	.10453	0.9945	.10510	9.514	84.0			
.1	.03664	.9993	.03667	27.27	.9	.1	.10626	.9943	.10687	9.357	.9			
.2	.03839	.9993	.03842	26.03	.8	.2	.10800	.9942	.10863	9.205	.8			
.3	.04013	.9992	.04016	24.90	.7	.3	.10973	.9940	.11040	9.058	.7			
.4	.04188	.9991	.04191	23.86	.6	.4	.11147	.9938	.11217	8.915	.6			
.5	.04362	.9990	.04366	22.90	.5	.5	.11320	.9936	.11394	8.777	.5			
.6	.04536	.9990	.04541	22.02	.4	.6	.11494	.9934	.11570	8.643	.4			
.7	.04711	.9989	.04716	21.20	.3	.7	.11667	.9932	.11747	8.513	.3			
.8	.04885	.9988	.04891	20.45	.2	.8	.11840	.9930	.11924	8.386	.2			
.9	.05059	.9987	.05066	19.74	.1	.9	.12014	.9928	.12101	8.264	.1			
3.0	.05234	0.9986	.05241	19.081	87.0	7.0	.12187	0.9925	.12278	8.144	83.0			
.1	.05408	.9985	.05416	18.464	.9	.1	.12360	.9923	.12456	8.028	.9			
.2	.05582	.9984	.05591	17.886	.8	.2	.12533	.9921	.12633	7.916	.8			
.3	.05756	.9983	.05766	17.343	.7	.3	.12706	.9919	.12810	7.806	.7			
.4	.05931	.9982	.05941	16.832	.6	.4	.12880	.9917	.12988	7.700	.6			
.5	.06105	.9981	.06116	16.350	.5	.5	.13053	.9914	.13165	7.596	.5			
.6	.06279	.9980	.06291	15.895	.4	.6	.13226	.9912	.13343	7.495	.4			
.7	.06453	.9979	.06467	15.464	.3	.7	.13399	.9910	.13521	7.396	.3			
.8	.06627	.9978	.06642	15.056	.2	.8	.13572	.9907	.13698	7.300	.2			
.9	.06802	.9977	.06817	14.669	.1	.9	.13744	.9905	.13876	7.207	.1			
	cos	sin	cot	tan	deg		cos	sin	cot	tan				

Table 1-35.! Trigonometric Functions! Continued

deg	sin	cos	tan	cot	deg	sin	cos	tan	cot	deg	sin	cos	tan	cot
8.0	.13917	0.9903	.14054	7.115	82.0	12.0	0.2079	0.9781	0.2126	4.705	78.0			
.1	.14090	.9900	.14232	7.026	.9	.1	.2096	.9778	.2144	4.665	.9			
.2	.14263	.9898	.14410	6.940	.8	.2	.2133	.9774	.2162	4.625	.8			
.3	.14436	.9895	.14588	6.855	.7	.3	.2130	.9770	.2180	4.586	.7			
.4	.14608	.9893	.14767	6.772	.6	.4	.2147	.9767	.2199	4.548	.6			
.5	.14781	.9890	.14945	6.691	.5	.5	.2164	.9763	.2217	4.511	.5			
.6	.14954	.9888	.15124	6.612	.4	.6	.2181	.9759	.2235	4.474	.4			
.7	.15126	.9885	.15302	6.535	.3	.7	.2198	.9755	.2254	4.437	.3			
.8	.15299	.9882	.15481	6.460	.2	.8	.2215	.9751	.2272	4.402	.2			
.9	.15471	.9880	.15660	6.386	.1	.9	.2233	.9748	.2290	4.366	.1			
9.0	.15643	0.9877	.15836	6.314	81.0	13.0	0.2250	0.9744	0.2309	4.331	77.0			
.1	.15816	.9874	.16017	6.243	.9	.1	.2267	.9740	.2327	4.297	.9			
.2	.15988	.9871	.16196	6.174	.8	.2	.2284	.9736	.2345	4.264	.8			
.3	.16160	.9869	.16376	6.107	.7	.3	.2300	.9732	.2364	4.230	.7			
.4	.16333	.9866	.16555	6.041	.6	.4	.2317	.9728	.2382	4.198	.6			
.5	.16505	.9863	.16734	5.976	.5	.5	.2334	.9724	.2401	4.165	.5			
.6	.16677	.9860	.16914	5.912	.4	.6	.2351	.9720	.2419	4.134	.4			
.7	.16849	.9857	.17093	5.850	.3	.7	.2368	.9715	.2438	4.102	.3			
.8	.17021	.9854	.17273	5.789	.2	.8	.2385	.9711	.2456	4.071	.2			
.9	.17193	.9851	.17453	5.730	.1	.9	.2402	.9707	.2475	4.041	.1			
10.0	.1736	0.9848	.1763	5.671	80.0	14.0	0.2419	0.9703	0.2493	4.011	76.0			
.1	.1754	.9845	.1781	5.614	.9	.1	.2436	.9699	.2512	3.981	.9			
.2	.1771	.9842	.1799	5.558	.8	.2	.2453	.9694	.2530	3.952	.8			
.3	.1788	.9839	.1817	5.503	.7	.3	.2470	.9680	.2549	3.923	.7			
.4	.1805	.9836	.1835	5.449	.6	.4	.2487	.9686	.2568	3.895	.6			
.5	.1822	.9833	.1853	5.396	.5	.5	.2504	.9681	.2586	3.867	.5			
.6	.1840	.9829	.1871	5.343	.4	.6	.2521	.9677	.2605	3.839	.4			
.7	.1857	.9826	.1890	5.292	.3	.7	.2538	.9673	.2623	3.812	.3			
.8	.1874	.9823	.1908	5.242	.2	.8	.2554	.9668	.2642	3.785	.2			
.9	.1891	.9820	.1926	5.193	.1	.9	.2571	.9664	.2661	3.758	.1			
11.0	.1908	0.9816	.1944	5.145	79.0	15.0	0.2588	0.9659	0.2679	3.732	75.0			
.1	.1925	.9813	.1962	5.097	.9	.1	.2605	.9655	.2698	3.706	.9			
.2	.1942	.9810	.1980	5.050	.8	.2	.2622	.9650	.2717	3.681	.8			
.3	.1959	.9806	.1998	5.005	.7	.3	.2639	.9646	.2736	3.655	.7			
.4	.1977	.9803	.2016	4.959	.6	.4	.2656	.9641	.2754	3.630	.6			
.5	.1994	.9799	.2035	4.915	.5	.5	.2672	.9636	.2773	3.606	.5			
.6	.2011	.9796	.2053	4.872	.4	.6	.2689	.9632	.2792	3.582	.4			
.7	.2028	.9792	.2071	4.829	.3	.7	.2706	.9627	.2811	3.558	.3			
.8	.2045	.9789	.2089	4.787	.2	.8	.2723	.9622	.2830	3.534	.2			
.9	.2062	.9785	.2107	4.745	.1	.9	.2740	.9617	.2849	3.511	.2			
	cos	sin	cot	tan	deg		cos	sin	cot	tan	deg			

Table 1-35.! Trigonometric Functions! Continued

deg	sin	cos	tan	cot	deg	sin	cos	tan	cot	deg	sin	cos	tan	cot
16.0	0.2756	0.9613	0.2867	3.487	74.0	20.0	0.3420	0.9397	0.3640	2.747	70.0			
.1	.2773	.9608	.2886	3.465	.9	.1	.3437	.9391	.3659	2.733	.9			
.2	.2790	.9603	.2905	3.442	.8	.2	.3453	.9385	.3679	2.718	.8			
.3	.2807	.9598	.2924	3.420	.7	.3	.3469	.9379	.3699	2.703	.7			
.4	.2823	.9593	.2943	3.398	.6	.4	.3486	.9373	.3719	2.689	.6			
.5	.2840	.9588	.2962	3.376	.5	.5	.3502	.9367	.3739	2.675	.5			
.6	.2857	.9583	.2981	3.354	.4	.6	.3518	.9361	.3759	2.660	.4			
.7	.2874	.9578	.3000	3.333	.3	.7	.3535	.9354	.3779	2.646	.3			
.8	.2890	.9573	.3019	3.312	.2	.8	.3551	.9348	.3799	2.633	.2			
.9	.2907	.9568	.3038	3.291	.1	.9	.3567	.9342	.3819	2.619	.1			
17.0	0.2924	0.9563	0.3067	3.271	73.0	21.0	0.3584	0.9336	0.3839	2.605	69.0			
.1	.2940	.9558	.3076	3.271	.9	.1	.3600	.9330	.3859	2.592	.9			
.2	.2957	.9553	.3096	3.230	.8	.2	.3616	.9323	.3879	2.578	.8			
.3	.2974	.9548	.3115	3.211	.7	.3	.3633	.9317	.3899	2.565	.7			
.4	.2990	.9542	.3134	3.191	.6	.4	.3649	.9311	.3919	2.552	.6			
.5	.3007	.9537	.3153	3.172	.5	.5	.3665	.9304	.3939	2.539	.5			
.6	.3024	.9532	.3172	3.152	.4	.6	.3681	.9298	.3959	2.526	.4			
.7	.3040	.9527	.3191	3.133	.3	.7	.3697	.9291	.3979	2.513	.3			
.8	.3057	.9521	.3211	3.115	.2	.8	.3714	.9285	.4000	2.500	.2			
.9	.3074	.9516	.3230	3.096	.1	.9	.3730	.9278	.4020	2.488	.1			
18.0	0.3090	0.9511	0.3249	3.078	72.0	22.0	0.3746	0.9272	0.4040	2.475	68.0			
.1	.3107	.9505	.3269	3.060	.9	.1	.3762	.9265	.4061	2.463	.9			
.2	.3123	.9500	.3288	3.042	.8	.2	.3778	.9259	.4081	2.450	.8			
.3	.3140	.9494	.3307	3.024	.7	.3	.3795	.9252	.4101	2.438	.7			
.4	.3156	.9489	.3327	3.006	.6	.4	.3811	.9245	.4122	2.426	.6			
.5	.3173	.9483	.3346	2.989	.5	.5	.3727	.9239	.4142	2.414	.5			
.6	.3190	.9478	.3365	2.971	.4	.6	.3843	.9232	.4163	2.402	.4			
.7	.3206	.9472	.3385	2.954	.3	.7	.3859	.9225	.4183	2.391	.3			
.8	.3223	.9466	.3404	2.937	.2	.8	.3875	.9219	.4204	2.379	.2			
.9	.3239	.9461	.3424	2.921	.1	.9	.3891	.9212	.4224	2.367	.1			
19.0	0.3256	0.9455	0.3443	2.904	71.0	23.0	0.3907	0.9205	0.4245	2.356	67.0			
.1	.3272	.9449	.3463	2.888	.9	.1	.3923	.9198	.4265	2.344	.9			
.2	.3289	.9444	.3482	2.872	.8	.2	.3939	.9191	.4286	2.333	.8			
.3	.3305	.9438	.3502	2.856	.7	.3	.3955	.9184	.4307	2.322	.7			
.4	.3322	.9432	.3522	2.840	.6	.4	.3971	.9178	.4327	2.311	.6			
.5	.3338	.9426	.3541	2.824	.5	.5	.3987	.9171	.4348	2.300	.5			
.6	.3355	.9421	.3561	2.808	.4	.6	.4003	.9164	.4369	2.289	.4			
.7	.3371	.9415	.3581	2.793	.3	.7	.4019	.9157	.4390	2.278	.3			
.8	.3387	.9409	.3600	2.778	.2	.8	.4035	.9150	.4411	2.267	.2			
.9	.3403	.9403	.3620	2.762	.1	.9	.4051	.9143	.4431	2.257	.1			
	cos	sin	cot	tan	deg		cos	sin	cot	tan	deg			

Table 1-35.! Trigonometric Functions! Continued

deg	sin	cos	tan	cot	deg	sin	cos	tan	cot	deg	sin	cos	tan	cot
24.0	0.4067	0.9135	0.4452	2.246	66.0	28.0	0.4695	0.8829	0.5317	1.881	62.0			
.1	.4083	.9128	.4473	2.236	.9	.1	.4710	.8821	.5340	1.873	.9			
.2	.4099	.9121	.4494	2.225	.8	.2	.4726	.8813	.5362	1.865	.8			
.3	.4115	.9114	.4515	2.215	.7	.3	.4741	.8805	.5384	1.857	.7			
.4	.4131	.9107	.4536	2.204	.6	.4	.4756	.8796	.5407	1.849	.6			
.5	.4147	.9100	.4557	2.194	.5	.5	.4772	.8788	.5430	1.842	.5			
.6	.4163	.9092	.4578	2.184	.4	.6	.4787	.8780	.5452	1.834	.4			
.7	.4179	.9085	.4599	2.174	.3	.7	.4802	.8771	.5475	1.827	.3			
.8	.4195	.9078	.4621	2.164	.2	.8	.4818	.8763	.5498	1.819	.2			
.9	.4210	.9070	.4642	2.154	.1	.9	.4833	.8755	.5520	1.811	.1			
25.0	0.4226	0.9063	0.4663	2.145	65.0	29.0	0.4848	0.8746	0.5543	1.804	61.0			
.1	.4242	.9056	.4684	2.135	.9	.1	.4863	.8738	.5566	1.797	.9			
.2	.4258	.9048	.4706	2.125	.8	.2	.4879	.8729	.5589	1.789	.8			
.3	.4274	.9041	.4727	2.116	.7	.3	.4894	.8721	.5612	1.782	.7			
.4	.4289	.9033	.4748	2.106	.6	.4	.4909	.8712	.5635	1.775	.6			
.5	.4305	.9028	.4770	2.097	.5	.5	.4924	.8704	.5658	1.767	.5			
.6	.4321	.9018	.4791	2.087	.4	.6	.4939	.8695	.5681	1.760	.4			
.7	.4337	.9011	.4813	2.078	.3	.7	.4955	.8686	.5704	1.753	.3			
.8	.4352	.9003	.4834	2.069	.2	.8	.4970	.8678	.5726	1.746	.2			
.9	.4368	.8996	.4856	2.059	.1	.9	.4985	.8669	.5750	1.739	.1			
26.0	0.4384	0.8988	0.4877	2.050	64.0	30.0	0.5000	0.8660	0.5774	1.7321	60.0			
.1	.4399	.8980	.4899	2.041	.9	.1	.5015	.8652	.5797	1.7251	.9			
.2	.4415	.8973	.4921	2.032	.8	.2	.5030	.8643	.5820	1.7162	.8			
.3	.4431	.8965	.4942	2.023	.7	.3	.5045	.8634	.5844	1.7113	.7			
.4	.4446	.8957	.4964	2.014	.6	.4	.5040	.8625	.5867	1.7045	.6			
.5	.4462	.8949	.4986	2.006	.5	.5	.5075	.8616	.5890	1.6977	.5			
.6	.4478	.8942	.5008	1.997	.4	.6	.5090	.8607	.5914	1.6909	.4			
.7	.4493	.8934	.5029	1.988	.3	.7	.5105	.8599	.5938	1.6842	.3			
.8	.4509	.8926	.5051	1.980	.2	.8	.5120	.8590	.5961	1.6715	.2			
.9	.4524	.8918	.5073	1.971	.1	.9	.5135	.8581	.5985	1.6709	.1			
27.0	0.4540	0.8910	0.5095	1.963	63.0	31.0	0.5150	0.8572	0.6009	1.6643	59.0			
.1	.4555	.8902	.5117	1.954	.9	.1	.5165	.8643	.6032	1.6577	.9			
.2	.4571	.8894	.5139	1.946	.8	.2	.5180	.8554	.6056	1.6512	.8			
.3	.4586	.8886	.5161	1.937	.7	.3	.5195	.8545	.6080	1.6447	.7			
.4	.4602	.8878	.5184	1.929	.6	.4	.5210	.8536	.6104	1.6383	.6			
.5	.4617	.8870	.5206	1.921	.5	.5	.5225	.8526	.6128	1.6319	.5			
.6	.4633	.8862	.5228	1.913	.4	.6	.5240	.8517	.6152	1.6255	.4			
.7	.4648	.8854	.5250	1.905	.3	.7	.5255	.8508	.6176	1.6191	.3			
.8	.4664	.8846	.5272	1.897	.2	.8	.5270	.8499	.6200	1.6128	.2			
.9	.4679	.8838	.5295	1.889	.1	.9	.5284	.8490	.6224	1.6066	.1			
cos	sin	cot	tan	deg	cos	sin	cot	tan	deg	cos	sin	cot	tan	deg

Table 1-35.! Trigonometric Functions! Continued

deg	sin	cos	tan	cot	deg	sin	cos	tan	cot	deg	sin	cos	tan	cot
32.0	0.5299	0.8480	0.6249	1.6003	58.0	36.0	.05878	0.8090	0.7265	1.3764	54.0			
.1	.5314	.8471	.6273	1.5941	.9	.1	.5892	.8080	.7292	1.3713	.9			
.2	.5329	.8462	.6297	1.5880	.8	.2	.5906	.8070	.7319	1.3663	.8			
.3	.5344	.8453	.6322	1.5818	.7	.3	.5920	.8059	.7346	1.3613	.7			
.4	.5358	.8443	.6346	1.5757	.6	.4	.5934	.8049	.7373	1.3564	.6			
.5	.5373	.8434	.6371	1.5697	.5	.5	.5948	.8039	.7400	1.3514	.5			
.6	.5388	.8425	.6395	1.5637	.4	.6	.5962	.8028	.7427	1.3465	.4			
.7	.5402	.8415	.6420	1.5577	.3	.7	.5976	.8018	.7454	1.3416	.3			
.8	.5417	.8406	.6445	1.5517	.2	.8	.5990	.8007	.7481	1.3367	.2			
.9	.5432	.8396	.6469	1.5458	.1	.9	.6004	.7997	.7508	1.3319	.1			
33.0	0.5446	0.8387	0.6494	1.5399	57.0	37.0	0.6018	0.7986	0.7536	1.3270	53.0			
.1	.5461	.8377	.6519	1.5340	.9	.1	.6032	.7976	.7563	1.3222	.9			
.2	.5476	.8368	.6544	1.5282	.8	.2	.6046	.7965	.7590	1.3175	.8			
.3	.5490	.8358	.6569	1.5224	.7	.3	.6060	.7955	.7518	1.3127	.7			
.4	.5505	.8348	.6594	1.5166	.6	.4	.6074	.7944	.7646	1.3079	.6			
.5	.5519	.8339	.6619	1.5108	.5	.5	.6088	.7934	.7673	1.3032	.5			
.6	.5534	.8329	.6644	1.5051	.4	.6	.6101	.7923	.7701	1.2985	.4			
.7	.5548	.8320	.6669	1.4994	.3	.7	.6115	.7912	.7729	1.2938	.3			
.8	.5563	.8310	.6694	1.4938	.2	.8	.6129	.7902	.7757	1.2892	.2			
.9	.5577	.8300	.6720	1.4882	.1	.9	.6143	.7891	.7785	1.2846	.1			
34.0	0.5592	0.8290	0.6745	1.4826	56.0	38.0	0.6157	0.7880	0.7813	1.2799	52.0			
.1	.5606	.8281	.6771	1.4770	.9	.1	.6170	.7869	.7841	1.2753	.9			
.2	.5621	.8271	.6796	1.4715	.8	.2	.6184	.7859	.7869	1.2708	.8			
.3	.5635	.8261	.6822	1.4659	.7	.3	.6198	.7848	.7898	1.2662	.7			
.4	.5650	.8251	.6847	1.4605	.6	.4	.6211	.7837	.7926	1.2617	.6			
.5	.5664	.8241	.6873	1.4550	.5	.5	.6225	.7826	.7954	1.2572	.5			
.6	.5678	.8231	.6899	1.4496	.4	.6	.6239	.7815	.7983	1.2527	.4			
.7	.5693	.8221	.6924	1.4442	.3	.7	.6252	.7804	.8012	1.2482	.3			
.8	.5707	.8211	.6950	1.4388	.2	.8	.6266	.7793	.8040	1.2437	.2			
.9	.5721	.8202	.6970	1.4335	.1	.9	.6280	.7782	.8069	1.2393	.1			
35.0	0.5736	0.8192	0.7002	1.4281	55.0	39.0	0.6293	0.7771	0.8098	1.2349	51.0			
.1	.5750	.8181	.7028	1.4229	.9	.1	.6307	.7760	.8127	1.2305	.9			
.2	.5764	.8171	.7054	1.4176	.8	.2	.6320	.7749	.8156	1.2261	.8			
.3	.5779	.8161	.7080	1.4124	.7	.3	.6334	.7738	.8185	1.2218	.7			
.4	.5793	.8151	.7107	1.4071	.6	.4	.6347	.7727	.8214	1.2174	.6			
.5	.5807	.8141	.7133	1.4019	.5	.5	.6361	.7716	.8243	1.2131	.5			
.6	.5821	.8131	.7159	1.3968	.4	.6	.6474	.7705	.8273	1.2088	.4			
.7	.5835	.8121	.7186	1.3916	.3	.7	.6388	.7694	.8302	1.2045	.3			
.8	.5850	.8111	.7212	1.3865	.2	.8	.6401	.7683	.8332	1.2002	.2			
.9	.5864	.8100	.7239	1.3814	.1	.9	.6414	.7672	.8361	1.1960	.1			
	cos	sin	cot	tan	deg		cos	sin	cot	tan	deg			

Table 1-35.! Trigonometric Functions! Continued

deg	sin	cos	tan	cot	deg	sin	cos	tan	cot	deg	sin	cos	tan	cot
40.0	0.6428	0.7660	0.8291	1.1918	50.0	43.0	0.6820	0.7314	0.9325	1.0724	47.0			
.1	.6441	.7649	.8421	1.1875	.9	.1	.6833	.7302	.9358	1.0686	.9			
.2	.6455	.7638	.8451	1.1833	.8	.2	.6845	.7290	.9391	1.0649	.8			
.3	.6468	.7627	.8481	1.1792	.7	.3	.6858	.7278	.9424	1.0612	.7			
.4	.6481	.7615	.8511	1.1750	.6	.4	.6871	.7266	.9457	1.0575	.6			
.5	.6494	.7604	.8541	1.1708	.5	.5	.6884	.7254	.9490	1.0538	.5			
.6	.6508	.7593	.8571	1.1667	.4	.6	.6896	.7242	.9523	1.0501	.4			
.7	.6521	.7581	.8601	1.1626	.3	.7	.6909	.7230	.9556	1.0464	.3			
.8	.6534	.7570	.8632	1.1585	.2	.8	.6921	.7218	.9590	1.0428	.2			
.9	.6547	.7559	.8662	1.1544	.1	.9	.6934	.7206	.9623	1.0392	.1			
41.0	0.6561	0.7547	0.8693	1.1504	49.0	44.0	0.6947	0.7193	0.9657	1.0355	46.0			
.1	.6574	.7536	.8724	1.1463	.9	.1	.6959	.7181	.9691	1.0319	.9			
.2	.6587	.7524	.8754	1.1423	.8	.2	.6972	.7169	.9725	1.0283	.8			
.3	.6600	.7513	.8785	1.1383	.7	.3	.6984	.7157	.9759	1.0247	.7			
.4	.6613	.7501	.8816	1.1343	.6	.4	.6997	.7145	.9793	1.0212	.6			
.5	.6626	.7490	.8847	1.1303	.5	.5	.7009	.7133	.9827	1.0176	.5			
.6	.6639	.7478	.8878	1.1263	.4	.6	.7022	.7120	.9861	1.0141	.4			
.7	.6652	.7466	.8910	1.1224	.3	.7	.7034	.7108	.9896	1.0105	.3			
.8	.6665	.7455	.8941	1.1184	.2	.8	.6794	.7337	.9260	1.0799	.2			
.9	.6678	.7443	.8972	1.1145	.1	.9	.6807	.7325	.9293	1.0761	.1			
42.0	0.6691	0.7431	0.9004	1.1106	48.0									
.1	.6704	.7420	.9036	1.1067	.9									
.2	.6717	.7408	.9067	1.1028	.8									
.3	.6730	.7396	.9099	1.0990	.7									
.4	.6743	.7385	.9131	1.0951	.6									
.5	.6756	.7373	.9163	1.0913	.5									
.6	.6769	.7361	.9195	1.0875	.4									
.7	.6782	.7349	.9228	1.0837	.3									
.8	.6794	.7337	.9260	1.0799	.2									
.9	.6807	.7325	.9293	1.0761	.1									
	cos	sin	cot	tan	deg		cos	sin	cot	tan	deg			

Julian Date Calendar

Table 1-36 is a Julian date calendar. In leap years you should add one day after 28 February. Leap years occur every four years. The last leap year was 1992; therefore, the next few leap years will be 1996, 2000, and 2004.

Table 1-36.—Julian Date Calendar

Day	Jan	Feb	Mar	Apr	May	June	July	Aug	Sept	Oct	Nov	Dec	Day
1	001	032	060	091	121	152	182	213	244	274	305	335	1
2	002	033	061	092	122	153	183	214	245	275	306	336	2
3	003	034	062	093	123	154	184	215	246	276	307	337	3
4	004	035	063	094	124	155	185	216	247	277	308	338	4
5	005	036	064	095	125	156	186	217	248	278	309	339	5
6	006	037	065	096	126	157	187	218	249	279	310	340	6
7	007	038	066	097	127	158	188	219	250	280	311	341	7
8	008	039	067	098	128	159	189	220	251	281	312	342	8
9	009	040	068	099	129	160	190	221	252	282	313	343	9
10	010	041	069	100	130	161	191	222	253	283	314	344	10
11	011	042	070	101	131	162	192	223	254	284	315	345	11
12	012	043	071	102	132	163	193	224	255	285	316	346	12
13	013	044	072	103	133	164	194	225	256	286	317	347	13
14	014	045	073	104	134	165	195	226	257	287	318	348	14
15	015	046	074	105	135	166	196	227	258	288	319	349	15
16	016	047	075	106	136	167	197	228	259	289	320	350	16
17	017	048	076	107	137	168	198	229	260	290	321	351	17
18	018	049	077	108	138	169	199	230	261	291	322	352	18
19	019	050	078	109	139	170	200	231	262	292	323	353	19
20	020	051	079	110	140	171	201	232	263	293	324	354	20
21	021	052	080	111	141	172	202	233	264	294	325	355	21
22	022	053	081	112	142	173	203	234	265	295	326	356	22
23	023	054	082	113	143	174	204	235	266	296	327	357	23
24	024	055	083	114	144	175	205	236	267	297	328	358	24
25	025	056	084	115	145	176	206	237	268	298	329	359	25
26	026	057	085	116	146	177	207	238	269	299	330	360	26
27	027	058	086	117	147	178	208	239	270	300	331	361	27
28	028	059	087	118	148	179	209	240	271	301	332	362	28
29	029	*	088	119	149	180	210	241	272	302	333	363	29
30	030		089	120	150	181	211	242	273	303	334	364	30
31	031		090		151		212	243		304		365	31

* In leap year, after February 28, add 1 to the tabulated number.

Windchill Factor

The windchill factor is a computation of the still-air temperature that would have the same cooling effect on exposed human skin as a given combination of temperature and wind speed. You should use table 1-37 as a computation chart to figure windchill factor.

Table 1-37.—Windchill Factors

ESTIMATED WIND SPEED (IN MPH)	ACTUAL THERMOMETER READING (°F)											
	50	40	30	20	10	0	-10	-20	-30	-40	-50	-60
	EQUIVALENT TEMPERATURE (°F)											
CALM	50	40	30	20	10	0	-10	-20	-30	-40	-50	-60
05	48	37	27	16	6	-5	-15	-26	-36	-47	-57	-68
10	40	28	16	4	-9	-24	-33	-46	-58	-70	-83	-95
15	36	22	9	-5	-18	-32	-45	-58	-72	-85	-99	-112
20	32	18	4	-10	-25	-39	-53	-67	-82	-96	-110	-124
25	30	16	0	-15	-29	-44	-59	-74	-88	-104	-118	-133
30	28	13	-2	-18	-33	-48	-63	-79	-94	-109	-125	-140
35	27	11	-4	-20	-35	-51	-67	-82	-98	-113	-129	-145
40	26	10	-6	-21	-37	-53	-69	-85	-100	-116	-132	-148
Wind speeds greater than 40 mph have little added effect.	LITTLE DANGER (for properly clothed person) Maximum danger of false sense of security.				INCREASING DANGER Danger from freezing of exposed flesh				GREAT DANGER			

Effects of Heat and Humidity

Humidity combines with heat to create a more uncomfortable apparent temperature. By using table 1-38 you can figure the apparent temperature caused by various combinations of air temperature and humidity. Remember, in heat waves the apparent temperatures may run 15 to 30 degrees higher in more humid areas.

Table 1-38.—Effects of Heat and Humidity

	Air Temperature ^a										
	70	75	80	85	90	95	100	105	110	115	120
Relative Humidity	Apparent Temperature ^a										
0%	64	69	73	78	83	87	91	95	99	103	107
10%	65	70	75	80	85	90	95	100	105	111	116
20%	66	72	77	82	87	93	99	105	112	120	130
30%	67	73	78	84	90	96	104	113	123	135	148
40%	68	74	79	86	93	101	110	123	137	151	
50%	69	75	81	88	96	107	120	135	150		
60%	70	76	82	90	100	114	132	149			
70%	70	77	85	93	106	124	144				
80%	71	78	86	97	113	136					
90%	71	79	88	102	122						
100%	72	80	91	108							

^aDegrees Fahrenheit

When apparent temperatures are between 90 and 105 degrees, heat cramps, heat exhaustion, and heatstroke are possible after prolonged exposure and physical activity. These become likely when apparent temperatures are between 105 and 130 degrees. Over 130 degrees, heatstroke is imminent. You should note that heatstroke can be fatal if medical care is delayed.

GENERAL MAINTENANCE

The general maintenance section provides you with information on cleaning solvents, lubricants, corrosion control, use of the oscilloscope, troubleshooting, classes of overhaul, and types of equipment modifications. It also provides information such as material identification, names of organizations that provide outside technical assistance, and publications and documents that will assist you in day-to-day maintenance.

Corrosion Control (Cleaning and Lubricating)

A corrosive atmosphere can damage unprotected electric and electronic equipment. You should be aware of the harmful effects of moisture and, in particular, salt spray and salt-impregnated air. To prevent corrosion, you should maintain an effective cleaning and lubricating schedule. Standard preventive maintenance (PMS) procedures provide only minimum protection. Any schedule should include dusting and cleaning, lubrication of moving parts, and the use of approved solvents or wetting agents to remove any dust, dirt, oil film, salt, or other contaminant.

Table 1-39 is a list of standard Navy lubricants and solvents and their uses, as specified in Military Standard 454M (MIL-STD-454M).

Table 1-39.—Standard Navy Lubricants and Solvents

SPECIFICATION NUMBER AND TITLE	UNIT OF ISSUE	GENERAL USE
W-P-236 Petrolatum, Technical	1 lb. can 5 lb. can	For use as a light grade of lubricating grease but not recommended for use as a lubricant in heavily loaded or hot running bearings. It may be used as a constituent in certain types of rust preventive compounds.
P-D-680 Dry Cleaning Solvent	5 gal. pail	For general cleaning of air filters, electronic equipment, and other general purpose cleanup.
MIL-G-23827 Grease, Aircraft and Instrument	1 oz. tube 4 oz. tube 8 oz. Tube 1 lb. can 5 lb. can 35 lb. pail	In ball, roller, needle bearings, gears and sliding and rolling surfaces of such equipment as instruments, cameras, electronic gear and aircraft control systems. Particularly suitable for equipment which must operate at both very low and very high temperatures for short periods. Does not contain extreme pressure or special antiwear additives. It is destructive to paint, natural rubber, and neoprene.
MIL-G-81322 Grease, Aircraft	5 lb. can 35 lb. pail	For lubrication and protection against corrosion of plain ball and roller bearings, and preservation of threads on ammunitions.
MIL-L-17331 Lubricating Oil Steam Turbine	5 gal. 55 gal.	In main turbines and gears, auxiliary turbine installation, certain hydraulic equipment general mechanical lubrication, and air compressors.
MIL-L-2105 Lubrication Oil Gear	5 gal. 1 gal. 55 gal.	For lubrication of automotive gear units, heavy duty industrial-type enclosed gear units, steering gears, and fluid-lubricated universal joints of automotive equipment.
MIL-L-6085 Lubricating Oil Instrument	1 1/2 oz. btl. 4 oz. can 1 qt.	For aircraft instruments, electronic equipment, or where a low evaporation oil is required for both high and low temperature application, and where oxidation and corrosion resistance are desirable. Destructive to paint, neoprene and rubber.
MIL-L-6086 Lubricating Oil Gear	1 gal. can 1 pt. can 1 gal. can 5 gal. drum	For use under extremely low temperature, mild extreme pressure-type oil with load carrying additive. General use in aircraft use in aircraft gear mechanisms, exclusive of engines.
MIL-L-17331 & MIL-L-17672 Lubricating Oil General Purpose	1 pt. 5 gal. 55 gal.	For all applications which require other than special lubricants, and which are subject to normal variation between ambient and operating temperature. Use in lieu of MIL-L-6085 when oil will be in contact with neoprene.

Table 1-40.—Old and New Specification Solvents

OLD MILITARY SPECIFICATION	NEW MILITARY SPECIFICATION	REFERENCE
14-P-1	VV-P-236	See Table 1-39
14-L-3	MIL-G-18709	See Table 1-39
14-G-10	MIL-G-16908	See Table 1-39
14-L-11	VV-G-632	See Table 1-39
14-O-12	VV-I-530	See Table 1-39
14-O-13	MIL-L-9000	See Table 1-39
14-O-15	MIL-L-17331	See Table 1-39
14-O-20	MIL-L-6085	See Table 1-39
AN-O-6a	MIL-L-7870	See Table 1-39
KS 7470	MIL-L-17672	See Table 1-39
MIL-S-16067	P-D-680	See Table 1-39
VV-0-401	VV-I-530	See Table 1-39
P-S-661	P-D-680	See Table 1-39
MIL-G-3545	MIL-G-81322	See Table 1-39
MIL-G-3278	MIL-G-23827	See Table 1-39

Table 1-41.—Manufacturer's Designations

MANUFACTURER DESIGNATION	MILITARY SPECIFICATION	UNIT OF ISSUE
Lubri-Plate No. 105	None	2 oz.
Lubri-Plate No. 110	None	1 lb.
Molykote "G"	None	1 lb.
Molykote M-77	None	1 lb.
Stoddard Solvent	P-D-680	
140-F	P-D-680	
MOS, Lube-Power	MIL-M-7866	10 oz.
GE 10C	VV-I-530	
GE SS4005	MIL-S-8660	1 oz.
Dow-Corning DC-4	MIL-S-8660	1 oz.
McLube MOS ₂ -210 (formerly MOS ₂ -200)	None	As Requested
McLube MOS ₂ - 1118	None	As Requested
Thermotex 000	None	1 lb.

Table 1-42.—Lubricants Used in Electronics Equipment But Not Listed In MIL-STD-454M

SPECIFICATION NUMBER AND TITLE	UNIT OF ISSUE	GENERAL USE
51-F-23 Hydraulic Fluid	5 gal.	Used in connection with the hydraulic transmission of power. For use with Synthetic Seal.
ASTM D-3699 Kerosene	55 gal. 5 gal.	
MIL-L-7870 Lubrication Oil General Purpose	4 oz. 1 qt. 1 gal.	Specially designed for use where an oil of low evaporation, possessing rust-protective properties, is desired.
VV-G-632 General Purpose Grease	35 lb. 100 lb.	Automotive chassis, suitable for lubrication of machinery equipped with pressure grease fitting.
MIL-G-81322.Grease Aircraft	1 lb. 8 oz.	Used in antifriction bearings operating at high speeds and high temperatures.
MIL-C-11090 Cleaning Compound	5 gal. 55 gal.	Used as a solvent for cleaning grease and oils.
MIL-L-17672 Lubrication Oil General Purpose	1 gal. 55 gal.	Used in steam turbines, hydraulic systems, water generators and hydraulic turbine governors.
VV-L-751 Lubrication oil	35 lb.	Cold weather. Warm weather. Hot weather. Used for lubricating chain, wire rope, exposed gears.

Table 1-43 contains a list of common cleaning and preservation materials that were compiled from Naval Air Technical Manual 16-1-540, *Avionic Cleaning and Corrosion Prevention Control*.

Table 1-43.—Cleaning Materials

Non-abrasive cleaning & polishing pad
Isopropyl alcohol TT-I-735
General purpose lubricating oil VV-L-800
Instrument grease MIL-G-8137
General purpose grease MIL-G-81322
Zip-lock plastic bags
Distilled water
Paint brush
Toothbrush
Pipe cleaners
Q tips
Face shield
Goggles
Rubber gloves
Magnifying glass
Vacuum cleaner
Hot air gun
Inspection mirror
Rubber bucket
Plastic spray bottle

Remember to use the proper safety precautions applicable to toxic, volatile solvents and flammable lubricants. You can refer to Naval Ships' Technical Manual (NSTM), Chapter 670, *Stowage, Handling, and Disposal of Hazardous General Use Consumables*, NAVSEA S9086-WK-STM-000.

Using the Oscilloscope

An oscilloscope can be used for more than just studying the shape of a waveform. By looking at lissajous patterns and using an *octopus*, you can compare the phase and frequency relationship of two signals and check electronic components in a circuit.

LISSAJOUS PATTERNS.—The simplest lissajous patterns are produced by two sine waves of the same frequency and amplitude being applied to the horizontal and vertical deflection voltage inputs of an oscilloscope. Figure 1-37 shows patterns for several common phase relationships. These can be used to estimate the approximate phase angle of the two signals being studied.

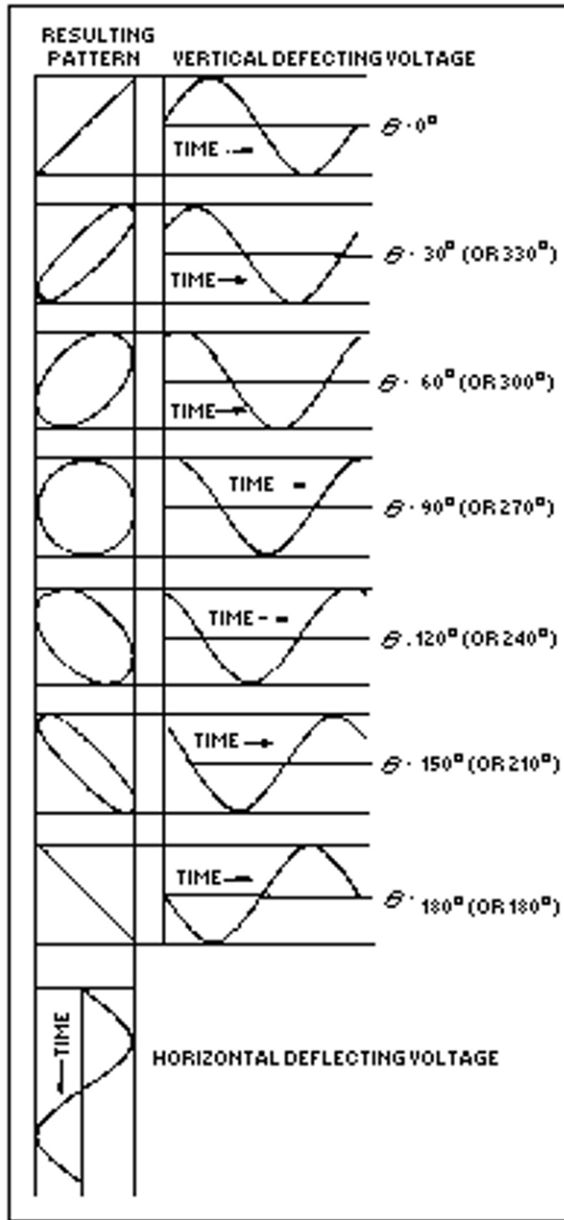

Figure 1-37.—Lissajous patterns, showing the effects of phase relationships.

Figure 1-38 will aid you in computing a phase angle if a more precise calculation is needed. We will use the graticule on the oscilloscope, a ratio formula, and sine (sin) table to compute the angle.

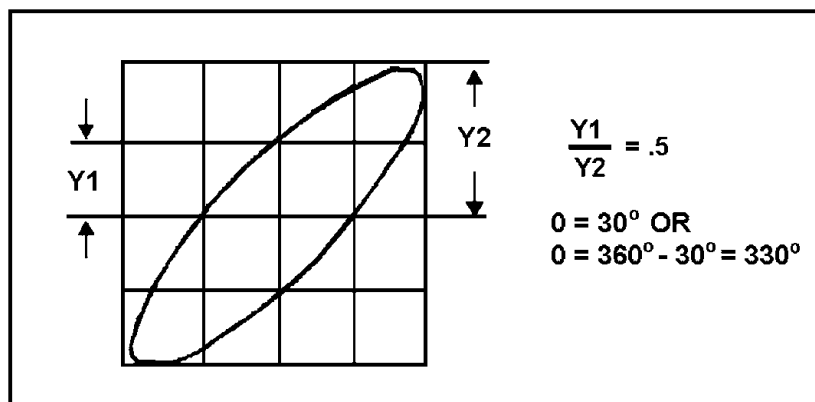

Figure 1-38.—Computation of phase angle.

To find the angle, we should first divide Y1 by Y2. We can then take that number, look it up in the sine portion of table 1-35, and read the angle.

For example, let's let each graticule in figure 1-36 represent 1 centimeter. Then,

$$\begin{aligned}
 Y1 &= 1 \\
 Y2 &= 2 \\
 \frac{Y1}{Y2} &= .5
 \end{aligned}$$

If we look for .5 in the sine column of table 1-35, we find that .5 is the value for the sine of 30 degrees.

The frequency ratio between two sine waves can also be determined from lissajous patterns. Figure 1-39 shows various frequency ratios between signals. Figure 1-40 and 1-41, views A, show how phase relationship can affect these patterns. If tangent lines are drawn across the top and down the side of the pattern, the ratio of points (free ends and loops) that touch these lines equals the frequency ratio. Figure 1-41 is an example of this method. Refer back to figure 1-39 and notice the relationship of loops and open ends in each example. You can find more detailed information on lissajous patterns in the Electronics Installation and Maintenance Book (EIMB), *Test Methods and Practices*, NAVSEA 0976-LP-000-0130.

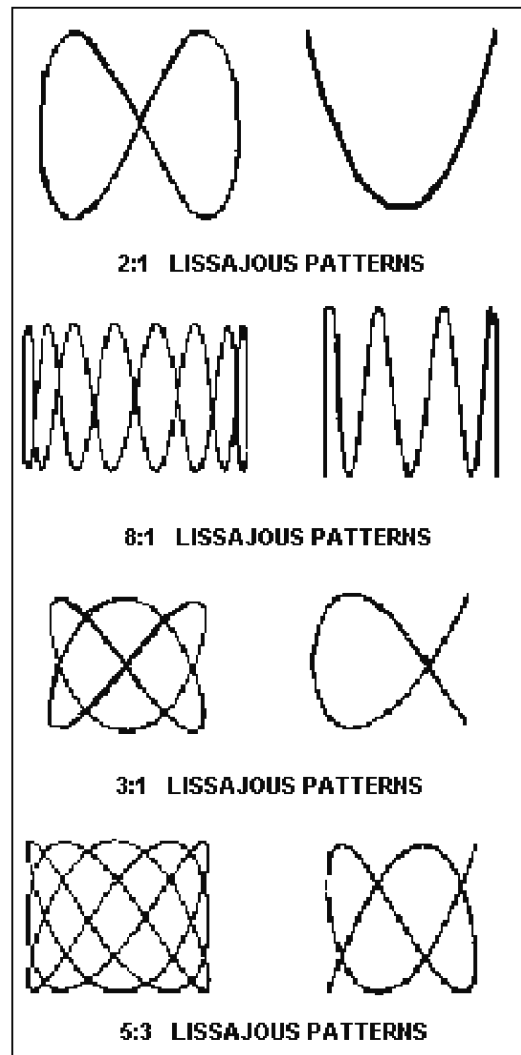

Figure 1-39.—Lissajous patterns of different frequency ratios.

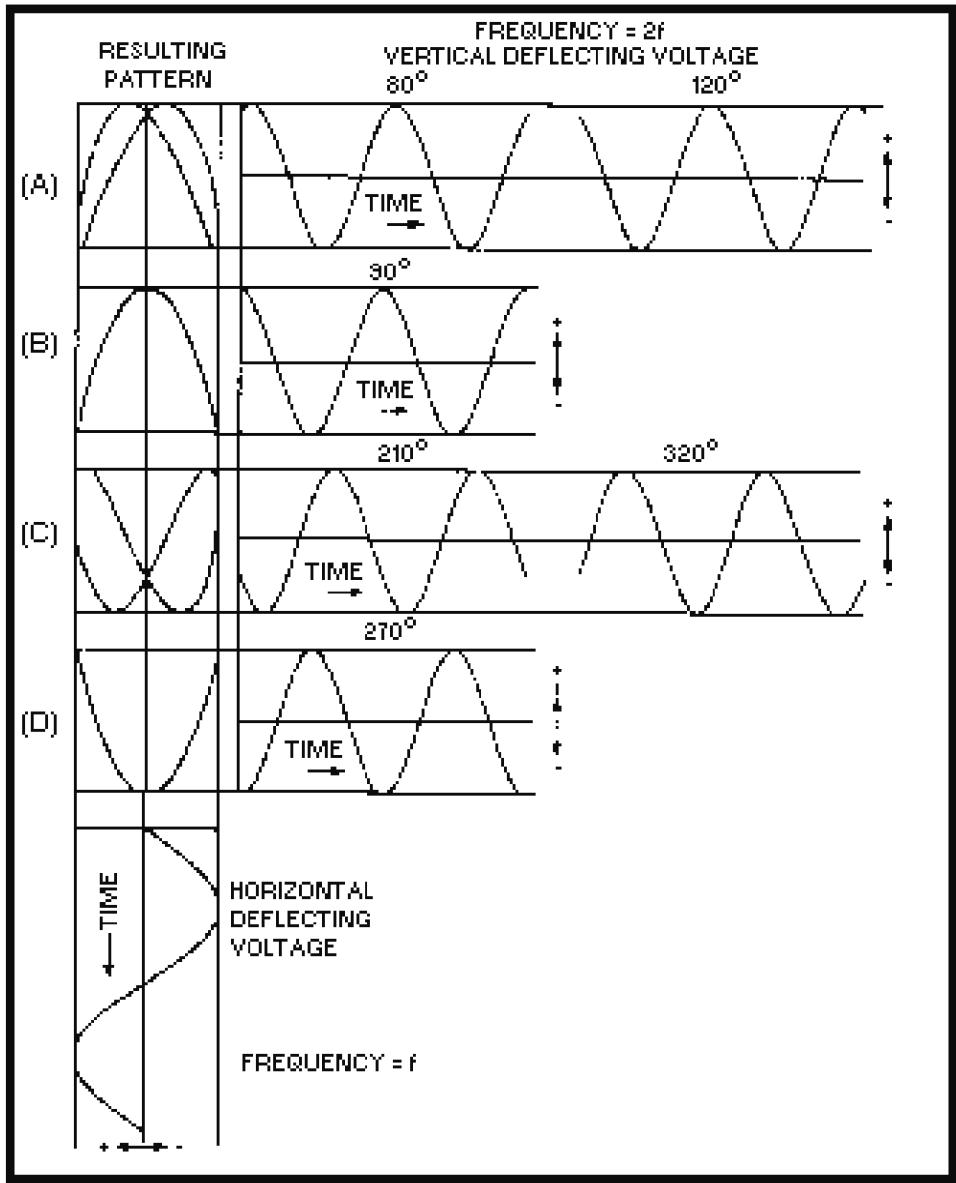

Figure 1-40.—Lissajous patterns for various phase relationships.

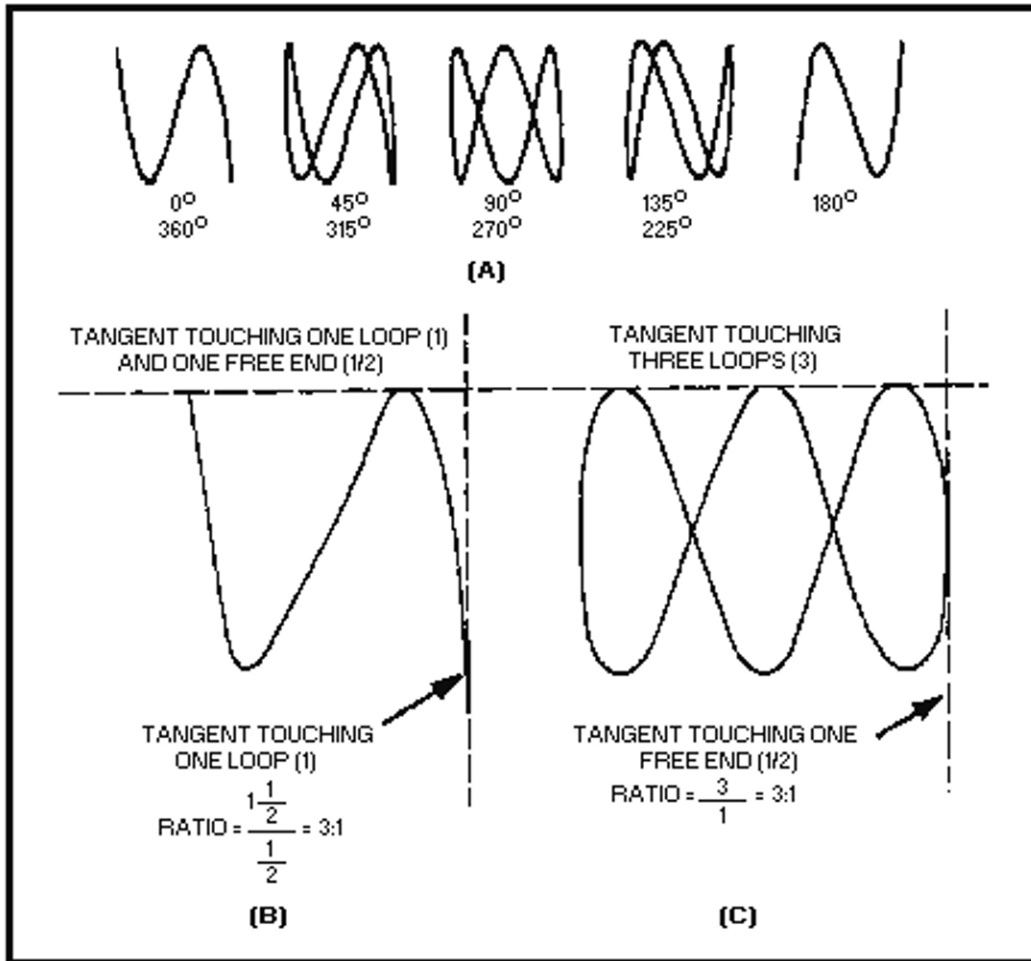

Figure 1-41—3:1 Lissajous patterns and calculation of frequency ratio.

THE OCTOPUS.—The octopus is a small, homemade test set used with an oscilloscope to check electronic components *in circuit*. It can be made easily and cheaply using parts from the supply system. Figure 1-42 is a schematic of an octopus that uses either a 6.3-volt filament transformer or an audio oscillator for input power. The benefits of *in circuit* troubleshooting with an octopus are (1) reduced maintenance time, (2) less chance of damage from soldering-iron heat, and (3) a visual display of the component's condition.

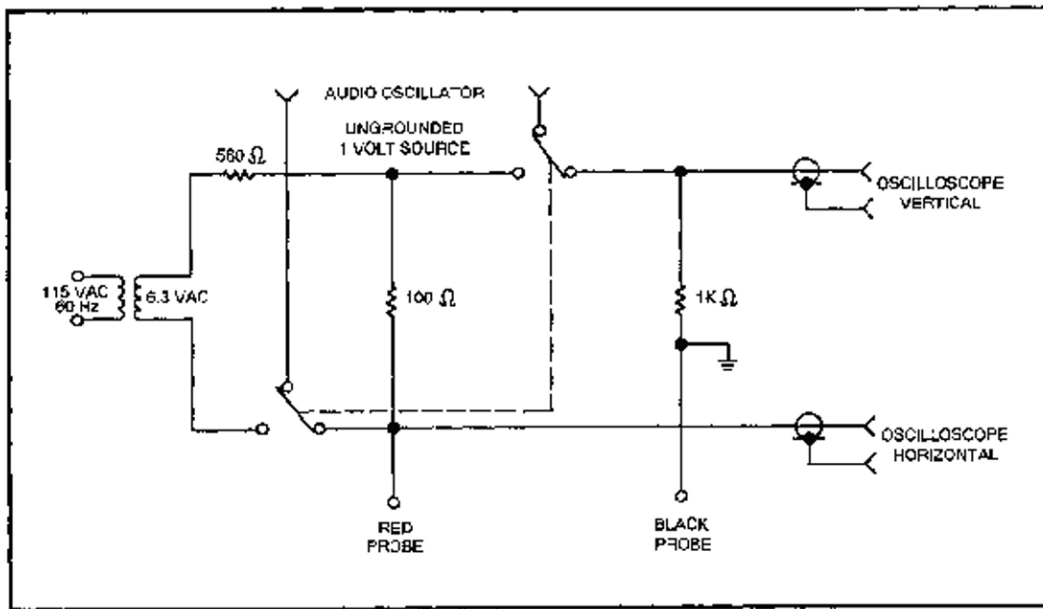

Figure 1-42.—Octopus schematic diagram (typical).

The octopus tests all components for shorts, high resistance, and opens; it checks front-to-back ratios on junction components (transistors and diodes); and it analyzes ICs and reactive components (capacitors and inductors). Figure 1-43 shows some typical oscilloscope displays obtained when the octopus is used. Figures 1-44, 1-45, and 1-46 depict transistor, potentiometer, and combination component displays, respectively. Detailed operating procedures can be found in topic 6 of NEETS, Module 16, *Introduction to Test Equipment*, and in the Electronic Installation and Maintenance Book (EIMB), *Test Methods and Practices*, NAVSEA SE000-00-EIM-130.

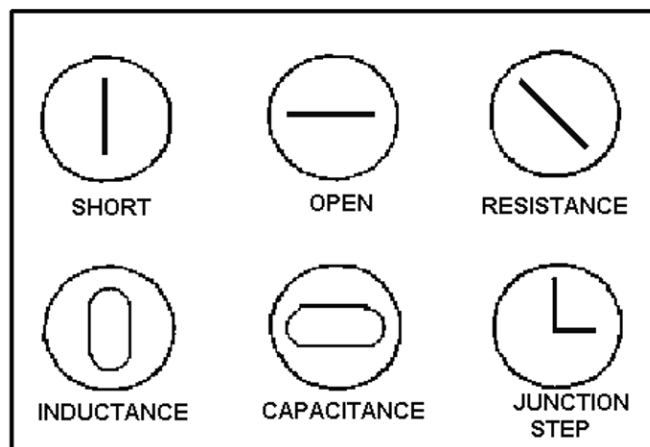

Figure 1-43.—Typical oscilloscope displays for an octopus.

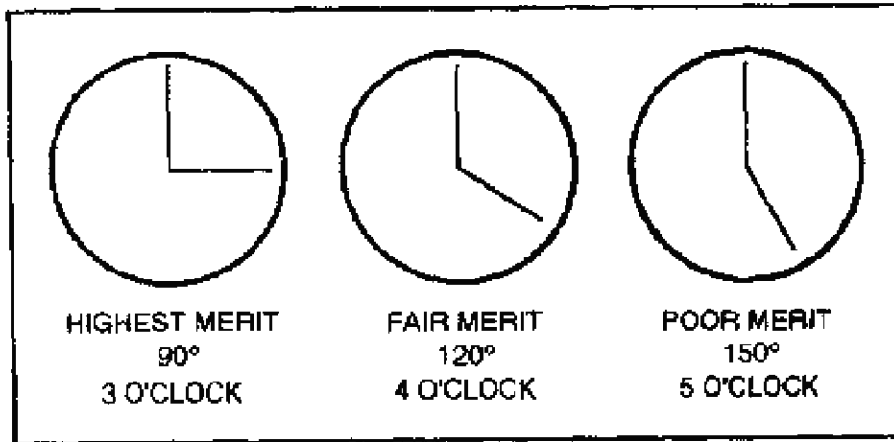

Figure 1-44.—Transistor check, single junction.

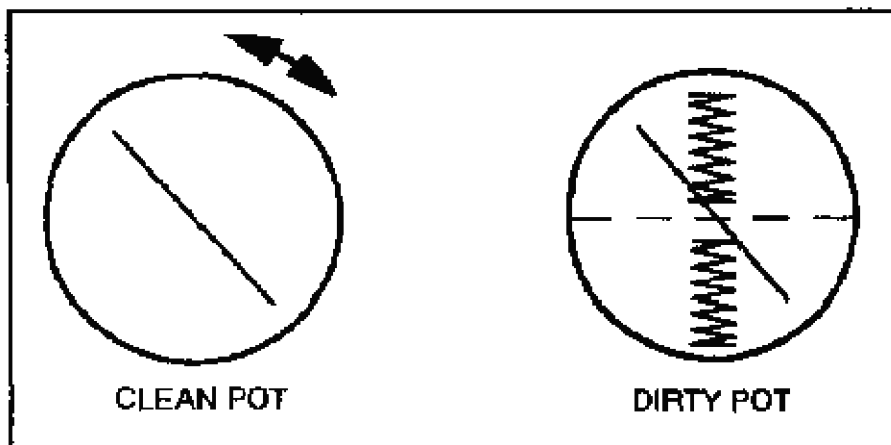

Figure 1-45.—Potentiometer noise check.

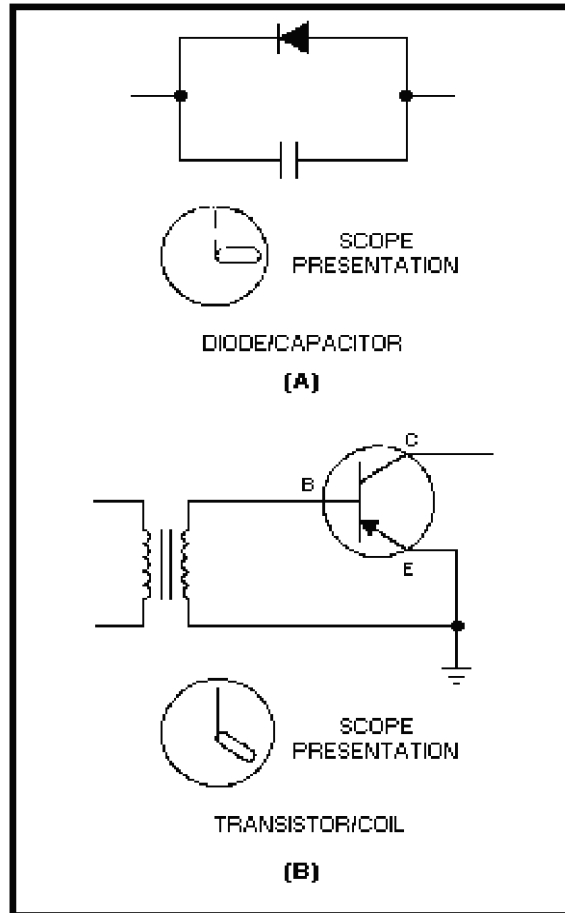

Figure 1-46.—Combination displays.

Six-Step Troubleshooting Procedure

You may have the job of maintaining or helping to maintain some electrical or electronic unit, subsystem, or system. Some of these jobs may be complex, but even a complex job can be broken down into simple steps. Basically, any repair of electric or electronic equipment should be done in the following order:

1. Symptom recognition. This is the action of recognizing some disorder or malfunction in electronic equipment.
2. Symptom elaboration. Obtaining a more detailed description of the trouble symptom is the purpose of this step.
3. Listing probable faulty functions. This step is applicable to equipment that contains more than one functional area or unit. From the information you have gathered, where could the trouble logically be located?
4. Localizing the faulty function. In this step you determine which of the functional units of the multiunit equipment is actually at fault.

5. Localizing trouble to the circuit. You will do extensive testing in this step to isolate the trouble to a specific circuit.
6. Failure analysis. This step is multipart. Here you determine which part is faulty, repair/replace the part, determine what caused the failure, return the equipment to its proper operating status, and record the necessary information in a recordkeeping book for other maintenance personnel in the future. While not a part of this step, the technician should reorder any parts used in repair of the faulty equipment.

Sometimes you may run into difficulty in finding (or troubleshooting) the problem. Some hints that may help in your efforts are:

- Observe the equipment's operation for any and all faults
- Check for any defective components with your eyes and nose
- Analyze the cause of the failure for a possible underlying problem

Classes of Overhaul Work

There are five classes of equipment overhaul (A, B, C, D, and E). The class defines the type and scope of work to be done on each equipment by the overhauling activity. (Do not confuse equipment overhaul with the term regular overhaul.)

CLASS A OVERHAUL.—A class A overhaul includes overhaul, repair, and/or modification; for example a modification could be an Ordnance Alteration (ORDALT), Special Program Alteration (SPALT), Ship Alteration (SHIPALT), or a field change that will sustain or improve the performance of a system or component to meet its most-recent design and technical specifications. The end product should be like new in appearance and operation.

CLASS B OVERHAUL.—A class B overhaul includes overhaul and repair that will restore the performance of a system or component to its original design and technical specifications. Modifications or alterations are not done unless specified by the customer.

CLASS C OVERHAUL.—A class C overhaul includes only repair work on a system or component specified by a work request or work required to correct malfunctions specified by the customer.

CLASS D OVERHAUL.—A class D overhaul includes work related to the open, inspect and report type of work request. It is intended to be diagnostic in nature and may require various tests. It is normally associated with preoverhaul test and inspection (POT& I).

CLASS E OVERHAUL.—A class E overhaul includes work required to incorporate all alterations and/or modifications specified for a system or component.

Alterations and Modifications to Equipment

Alterations and modifications to shipboard systems and equipment may take several forms. Some of these are Ship Alterations (SHIPALTS), Ordnance Alterations (ORDALTS), Special Program Alterations (SPALTS), and Air Alterations (AIRALTS). These alterations (with the exception of electronic equipment field changes) are categorized as follows:

- A military alteration that changes or improves the operational or military characteristics of a ship.
- A technical alteration that generally concerns personnel safety and equipment effectiveness.
- An alteration-equivalent-to-repair (AER) could be one of three types. One involves substitution, without change in design, of approved, different material, available from standard stock. The second involves replacement of worn or damaged parts, assemblies, or equipment with those of later and more efficient design that have been approved by the responsible systems command. The last type is used for strengthening of parts that need repair or replacement to improve the reliability of the parts, provided no other change in design is involved.

ALTERATION RESPONSIBILITIES.—Ship alterations (SHIPALTS) involve material under the technical control of the Naval Sea Systems Command (NAVSEA). Alterations which affect shipboard systems and equipment under the technical control of other systems commands; for example, air alterations (AIRALTS), ordnance alterations (ORDALTS), and special program alterations (SPALTS), are not SHIPALTS. However, they may require concurrent SHIPALTS if changes affect shipboard system interface.

ELECTRONIC EQUIPMENT FIELD CHANGES.—Field changes are identified by type and class. The type depends on the material included in the change kit or furnished by the installing activity. The class refers to the funding and the installation responsibility.

Details concerning various types of and approval authority for alterations can be found in the Electronics Installation and Maintenance Book (EIMB), *General*, NAVSEA SE000-00-EIM-100.

Material Identification

At some time in your work, you will probably have to replace a defective part or component. If you are familiar with national stock numbers (NSNs), Navy item control numbers (NICNs), part numbers (PNs), and the Coordinated Shipboard Allowance List (COSAL), getting the replacement should be a simple chore.

NATIONAL STOCK NUMBERS (NSNs).—An NSN is a 13-digit stock number used to identify an item of material in the Federal Catalog System of the Department of Defense. It consists of a four-digit federal supply classification (FSC) and a nine-digit national item identification number (NIIN). The first two digits of the FSC denote the group or major division of materials and the last two digits denote the class of subdivision of material within a group.

Examples of groups are:

GROUP	TITLE
31	Bearings
48	Valves
59	Electrical and Electronic Systems Components
79	Cleaning supplies

A complete listing of groups is provided in NAVSUP P-485, *Afloat Supply Procedures*. The NIIN consists of a two-digit national codification bureau (NCB) code and seven digits which, in conjunction with the NCB code, uniquely identify each NSN item in the Federal Supply System. For example:

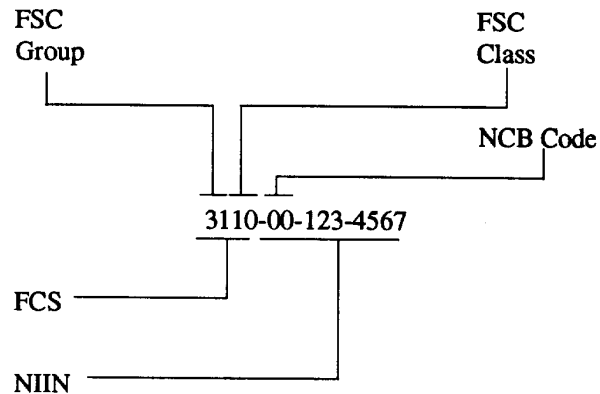

Two NCB codes are assigned for the United States, 00 and 01. Code 00 identifies all FSNs (11-digit federal stock numbers used prior to NSNs) assigned prior to 31 March 1975. Code 01 identifies the numbers assigned after that time. The NCBs must be included and be correct, or the material may be rejected or you may receive the wrong material.

NAVY ITEM CONTROL NUMBERS (NICNs).—Material not included in the Federal Catalog System, but stocked or monitored in the Navy Supply System, are listed by 13-character Navy item control numbers (NICNs). These NICNs are readily identified by a two-position alpha code which signifies the type of NICN. This code and a seven-position alphanumeric uniquely identify each NICN item in the Navy Supply System. NICN codes that are currently used and examples of NICNs follow:

NICN CODE	APPLICATION	EXAMPLE
LE	Poseidon items common to Trident	1220-LE-F00-4016
LF	Stock numbers for forms	1018-LF-504-2201
LK	Aircraft change kit numbers	1234-LK-UA1-2345
LP	Stock numbers for publications	0530-LP-485-0000
LS	Special programs alteration kit numbers	1234-LS-123-4567
LX	ASO local control numbers	1560-LX-NPI-2345
LL	Local control numbers (Temporary)	4820-LL-000-1234
	Local control numbers (Permanent)	7520-LL-CAO-0001

Note: The permanent local control number can always be recognized by a C in the seventh position.

Parts can be ordered by using a NIIN or NICN.

PART NUMBERS (PNs).—A part number (also known as reference number) may be used to identify a material item or to assist you in finding the current NSN. Part numbers include old NSNs, FSNs, electron tube type numbers, and electronic equipment circuit symbol numbers. Two other important sources for reference numbers are manufacturers' part numbers and Navy drawing and piece

numbers. They can be easily converted to NSNs by using the *Master Cross-Reference List (MCRL)*. Table 1-44 shows excerpts from the MCRL. If the part or reference numbers do not cross to an NSN, the P/N can be used to order the replacement. A good source of part numbers is the parts list in the equipment technical manual.

Table 1-44.—Excerpts from Master Cross-Reference List (MCRL)

FEDERAL SUPPLY CODE
FOR MANUFACTURERS



JIT	REF NO	FSCM	NSN	I S C	R N Y C	R N C C	S A D C	D A	ITEM NAME
	CBTV545A	80009	5625-00-714-3992* 5625-00-225-0248	3	2	5			OSCILLOSCOPE
	CBTYPE102	77075	8030-00-734-9314	5	2	3		N	COMPOUND, CALKIN
	CBT22200D	23040	2530-00-062-0345* 2530-00-278-2267	2	2	5			CUP, HYDRAULIC B
	CBT26256A	23040	3020-00-499-9631	6	2	3		N	SPROCKET, DRIVE
	CBT12	85537	3460-00-586-6650	5	2	3			CHIP BREAKER
	CBT13-023	80103	5910-00-500-9119	3	2	3			CAPACITOR, FIXED

PART - 1

(REFERENCE NUMBER - TO - NEW)

NSN	I S C	REF NO	FSCM	R N Y C	R N C C	S A D C	D A	ITEM NAME
5905-00-714-3979	3	5905-00-503-5984*						
6625-00-714-3990	5	10656-307	94756	2	3		N	PULLEY, FLAT WEB
6625-00-714-3992*	3	CBTV545A	80009	2	5			OSCILLOSCOPE
		PC834900041-5	33597	2	3			OSCILLOSCOPE
		1011931	55232	2	5			OSCILLOSCOPE
		1548298	10001	2	3			OSCILLOSCOPE
		1842288	30003	2	5			OSCILLOSCOPE
		545A	80009	2	3			OSCILLOSCOPE
		9975256	18876	7	5			OSCILLOSCOPE
		6625-00-225-0248						
6625-00-714-3993	6	6587	47496	2	3			METER, ELECTRICAL

PART - 2

(NSN - TO - REFERENCE NUMBER)

COORDINATED SHIPBOARD ALLOWANCE LIST (COSAL).—The COSAL can help you to identify repair or replacement parts. Part IIB of the COSAL is a cross-reference (microfiche only) from circuit symbol number to PN/NIIN/NICN. These parts are normally carried onboard ship for ready issue.

Outside Assistance

Your command may from time to time request assistance from another activity. This outside assistance is usually for the purpose of training, technical assistance on unusual design, planning, installation, or solving maintenance problems. Many of these activities exist throughout the fleet and shore establishments. Their capabilities and areas of responsibility differ just as equipment and systems differ. Several of the more widely known activities are included below.

MOBILE TECHNICAL UNITS (MOTU).—MOTUs provide on-the-job training and technical assistance for shipboard NAVSEA-SYSCOM/NAVELEXSYSCOM systems and equipment. They are staffed by senior military personnel and Contractor Engineering and Technical Services (CETS) representatives. MOTU's and NAUSEA combined about 10 years ago to form FTSCCLANT/PAC.

MOTUs are located in the following areas:

- FTSCCLANT/PAC
- Pearl Harbor, Hawaii
- Norfolk, Va.
- Groton, Conn.
- San Diego, Calif.
- Naples, Italy
- Yokosuka, Japan
- Mayport, Fla.
- NSB Kings Bay, Ga.
- Seattle, Wash.

NAVAL SEA SYSTEMS COMMAND (NAVSEA).—NAVSEA provides technical assistance through the use of direct fleet support technicians (TECHREP). These technicians are not to be used primarily as repairmen. The objective of their services is to promote fleet readiness and maintenance self-sufficiency. NAVSEATECHREP are located at Naval Sea Support Centers (NAVSEACENs) in Portsmouth, Va., and San Diego, Calif. They are also located at Fleet Support Offices (FSOs) in Mayport, Fla., Charleston, S.C., and New London, Conn. Selected equipment may have services provided by NAVSES, Philadelphia, or NAVSHIPWPNSYSENGSTA (NSWSES), Port Hueneme, Calif.

NAVAL ELECTRONIC SYSTEMS COMMAND (NAVELEX).—NAVELEX equipment is supported by the Fleet Liaison Program. Training and technical assistance is provided by civilian technicians at six NAVELEX field activities. Five are Naval Electronic Systems Engineering Centers (NESECs) and one is a Naval Electronic Systems Engineering Activity (NESEA). Fleet Liaison Offices are located at NESEC Washington, D.C., NESEC Charleston, S.C., NESEC Portsmouth, Va., NESEC San Diego, Calif., NESEC Vallejo, Calif., and NESEA St. Inigoes, Md.

NAVAL AIR SYSTEMS COMMAND (NAVAIR).—NAVAIR established the Navy Engineering and Technical Services (NETS) program to provide a source of technical and training assistance expertise. The program is comprised of military and civilian personnel. These people are qualified to provide advice, instruction, and training to support the installation, operation, and maintenance of Navy weapons, weapon-systems, and equipment. NETS technicians are assigned and administered by the Pacific Missile Test Center, Point Mugu, Calif., and the Naval Aviation Engineering Service Unit (NAESU), Philadelphia, Pa.

The Pacific Missile Test Center provides engineering and technical services on air-launched missile systems, air-launched guided weapons, Navy target systems, conventional ordnance, and associated

support equipment. All aircraft equipment and systems not specified above are the responsibility of the Naval Aviation Engineering Service Unit (NAESU).

NAVAL AVIATION ENGINEERING SERVICE UNIT (NAESU).— NAESU provides field engineering assistance and instruction in installation, repair, and operation of all types of aviation systems and equipment to naval aviation fleet and shore activities throughout the world. This is accomplished by detachments (NAESU DETs) at the following locations:

Atlanta, Ga.	Miramar, Calif.
Atsugi, Japan	Misawa, Japan
Barbers Point, Hawaii	Moffett Field, Calif.
Beaufort, S.C.	Naples, Italy
Bermuda	New Orleans, La.
Brunswick, Maine	New River, N.C.
Cecil Field, Fla.	Norfolk, Va
Cherry Point, N.C.	Oceana, Va.
China Lake, Calif.	Okinawa, Japan
Corpus Christi, Tex.	Patuxent River, Md.
Cubi Point, Philippines	Pensacola, Fla.
Dallas, Tex.	Point Mugu, Calif.
Detroit, Mich.	Rota, Spain
El Toro, Calif.	San Diego, Calif.
Glenview, Ill.	Sigonella, Sicily
Agana, Guam	South Weymouth, Mass.
Iwakuni, Japan	Washington, D.C.
Jacksonville, Fla.	Whidbey Island, Wash.
Kaneohe Bay, Hawaii	Willow Grove, Pa.
Key West, Fla.	Yuma, Ariz.
Lemoore, Calif	Memphis, Tenn

CARRIER AND FIELD SERVICE UNITS (CAFSUs).— CAFSUs furnish technical guidance and assistance to shipyards, ship repair facilities, and shore and fleet personnel concerning the installation, operation, maintenance, and testing of shipboard NAVAIR equipment. This equipment includes catapults, arresting gear, visual landing aids, flight deck lighting, pilot landing aid television (PLAT) systems, Fresnel-lens optical landing systems (FLOLS), and integrated launch and recovery television surveillance (ILARTS) systems.

CAFSUs are under the administrative control of the Naval Air Engineering Center (NAEC), Lakehurst, N.J., and are located at the following activities:

NAS Norfolk, Va.	SRF Subic Bay, Philippines
NAVSTA Mayport, Fla.	NAEC Philadelphia, Pa.
NAF Naples, Italy	SRF Yokosuka, Japan
NAS North Island, Calif.	NAS Alameda, Calif.

INTERMEDIATE MAINTENANCE ACTIVITIES (IMAs).—Afloat **IMAs** (tenders and repair ships) and shore **IMAs** (**SIMAs**) provide maintenance support for repairs beyond the capabilities of ship's force. **IMAs** also have facilities for test equipment calibration and emergency parts manufacture. Electrical, electronic, and ordnance repair divisions provide repairs on various equipment including gyrocompasses, navigational equipment, film projectors, internal communications, sonar, radar, IFF,

radio receivers and transmitters, test antennas, guns and small arms, torpedoes, fire control, and missile systems. Table 1-45 lists the various IMAs and their locations.

Table 1-45.—Intermediate Maintenance Activities

<u>A. DESTROYER TENDER (AD)</u>			
SIERRA	AD	18	CHARLESTON
YOSEMITE	AD	19	MAYPORT
SAMUEL GOMPERS	AD	37	SAN DIEGO
PUGET SOUND	AD	38	GAETA
YELLOWSTONE	AD	41	NORFOLK
ACADIA	AD	42	SAN DIEGO
CAPE COD	AD	43	SAN DIEGO
SHENANDOAH	AD	44	NORFOLK
 <u>B. REPAIR SHIP (AR)</u>			
VULCAN	AR	5	NORFOLK
JASON	AR	8	PEARL HARBOR
 <u>C. SUBMARINE TENDER (AS)</u>			
FULTON	AS	11	QUINCY
ORION	AS	18	LA MADDALENA
PROTEUS	AS	19	GUAM
HUNLEY	AS	31	HOLY LOCH
HOLLAND	AS	32	CHARLESTON
SIMON LAKE	AS	33	KINGS BAY
CANOPUS	AS	34	CHARLESTON
L Y SOEAR	AS	36	NORFOLK
DIXON	AS	37	SAN DIEGO
EMORY S LAND	AS	39	NORFOLK
FRANK CABLE	AS	40	CHARLESTON
MCKEE	AS	41	SAN DIEGO
 <u>D. SHORE INTERMEDIATE MAINTENANCE ACTIVITY</u>			
SIMA CHARLESTON			CHARLESTON
SIMA GUANTANAMO BAY			GUANTANAMO
SIMA LITTLE CREEK			LITTLE CREEK
SIMA (NRMF) NEWPORT			NEWPORT R.I.
SIMA MAYPORT			MAYPORT
SIMA NORFOLK			NORFOLK
SIMA PORTSMOUTH VA			PORTSMOUTH VA
SIMA (NRMF) PHILADELPHIA			NB PHILA
SIMA SAN DIEGO			SAN DIEGO
SIMA PEARL HARBOR			PEARL HARBOR
SIMA SAN FRANCISCO			ALAMEDA
SIMA LONG BEACH			LONG BEACH

Publications and Documents

Various publications, some of which are discussed below, are available for guidance in maintenance work or for reference and study. In general, these publications are available from the Naval Publications and Forms Center through the supply system.

NAVAL SHIPS' TECHNICAL MANUAL (NSTM).—The Naval Ships' Technical Manual (NSTM) is a prime reference for information on NAVSEA equipment. Chapter 400, *Electronics*, is most useful as it provides major policies and instructions pertaining to electronics work and material under NAVSEA and NAVELEX responsibility. Other chapters of interest to electrical and electronics technicians are:

300	Electrical Plant General
302	Electric Motors and Controllers
310	Electric Power Generators and Conversion Equipment
320	Electric Power Distribution Systems
330	Lighting
430	Interior Communication Installations
434	Motion Picture Equipment
491	Electrical Measuring and Test Instruments
510	Ventilating, Heating, Cooling, and Air-Conditioning Systems for Surface Ships
532	Liquid-Cooling Systems for Electronic Equipment
9006	Submarine Antennas and Masts
634	Deck Coverings

ELECTRONICS INSTALLATION AND MAINTENANCE BOOK (EIMB).—The Electronics Installation and Maintenance Book series supplements instructions and data supplied in equipment technical manuals. The EIMB is intended to reduce time-consuming research on electronic equipment and circuit theory. These handbooks fall into two categories: general information and equipment-oriented handbooks. The latter includes general test procedures, adjustments, and general servicing information. All handbooks of the series are listed below.

<u>TITLE</u>	<u>NUMBERS</u>
	<u>GENERAL</u>
General	SE000-00-EIM-100
Installation Standards	0967-LP-000-0110
Electronic Circuits	0967-000-0120
Test Methods & Practices	0967-LP-000-0130
Reference Data	0967-000-0140
EMI Reduction	0967-000-0150
General Maintenance	SE000-00-EIM-160
	<u>EQUIPMENT-ORIENTED</u>
Communications	SE000-00-EIM-010
Radar	SE000-00-EIM-020
Sonar	SE000-00-EIM-030
Test Equipment	SE000-00-EIM-040
Radiac	0967-000-0050
Countermeasures	SE000-00-EIM-07

ENGINEERING INFORMATION BULLETIN (EIB).—The *Engineering Information Bulletin* is published biweekly and distributed to all naval ships and electronics installation and maintenance activities. It is authoritative and is a means of rapid dissemination of advanced hull, mechanical, electronic, electrical, and related equipment information. It includes information concerning approved beneficial suggestions, electronics field changes, mechanical alterations (MECHALTS), installation techniques, maintenance notes and practices, and technical manual availabilities, advance change notices, and distribution.

EQUIPMENT TECHNICAL MANUALS.—Technical manuals carry information essential to the proper operation, maintenance, and repair of specific equipment. These manuals may occasionally contain errors. In those cases, change notices are provided to correct the manuals. Updates because of equipment changes are also provided. These changes must be installed in the technical manuals to maintain accuracy and to prevent the loss of man-hours resulting from the use of obsolete data and/or schematics. The *Guide for User Maintenance of NAVSEA Technical Manuals*, NAVSEA S005-AA-GYD-030/TMMP, provides information on identifying, ordering, deficiency reporting, and updating technical manuals.

NAVSUP PUBLICATION 2002.—NAVSUP 2002 is the *Navy Stock List of Publication and Forms* and provides NSNs for ordering Navy publications and their changes. Each edition is issued quarterly and supersedes the previous one in its entirety. It is produced in *microfiche* only and contains three sections:

Section 1—Forms

Section 2—Publications

Section 3—NAVAIR Technical Directives

DECKPLATE.—The *deckplate* is a technical periodical published monthly by NAVSEA. It contains information on design, construction, conversion, operation, maintenance, and repair of Navy vessels and their equipment. It also includes articles on personnel safety, service hints, and adopted beneficial suggestions.

NAVAL SAFETY CENTER PUBLICATIONS.—The Naval Safety Center publishes bulletins and several periodicals to keep Navy personnel informed on the subject of accident prevention.

- *Ship Safety Bulletin*—This monthly newsletter contains safety notes and accident data.
- *Fathom*—This quarterly magazine contains a review of surface ship and submarine accident prevention and safety articles.
- *Approach*—This magazine is a monthly review of articles concerning aviation safety and accident prevention.
- *MECH*—MECH is a bimonthly review of aviation maintenance related mishaps, material/personnel hazards, and general aviation ground safety.

TRAINING MANUALS (TRAMANS).—Training manuals are designed to give enlisted personnel background knowledge for the proper performance of their assigned jobs. Electrical and electronic theory and operation and maintenance information on pertinent equipment are presented at different rating levels in the TRAMANS written for the technical rates.

APPENDIX I

REFERENCES USED TO DEVELOP THIS NRTC

NOTE: Although the following references were current when this NRTC was published, their continued currency cannot be assured. When consulting these references, keep in mind that they may have been revised to reflect new technology or revised methods, practices, or procedures; therefore, you need to ensure that you are studying the latest references.

Afloat Shopping Guide, *NAVSUP Publication 4400, Naval Supply Systems Command, Washington, D.C., 1991.*

Afloat Supply Procedures, *NAVSUP Publication 485, 0530-LP-185-7600, Naval Supply Systems Command, Washington, D.C., 1989.*

Avionic Cleaning and Corrosion Prevention/Control, *NAVAIR 16-1-540, Naval Air Systems Command, Washington, D.C., 1984.*

Basic Military Requirements, *NAVEDTRA 10054-F, Naval Education and Training Professional Development and Technology Center, Pensacola, Fla., 1986.*

Cable Comparison Handbook, *Military Standard MIL-STD 299, Department of Defense, Washington, D.C., 1989.*

Capacitors, Selection and Use of, *Military Standard MIL-STD-198E, Department of Defense, Washington, D.C., 1984.*

Circuit Breakers, Selection and Use of, *Military Standard MIL-STD-1498B, Department of Defense, Washington, D.C., 1988.*

Design Data Book, *USN Ships NAVSEA 0902-LP-006-0000, Naval Sea Systems Command, Washington, D.C., 1988.*

Electrical Connectors, Plug-in Sockets, and Associated Hardware, Selection and Use of, Military Standard MIL-STD-1353B, Department of Defense, Washington, D.C., 1980.

Electronics Installation and Maintenance Book (EIMB), General, Naval Sea Systems Command, Washington, D.C., NAVSEA SE000-00-EIM-100, 1983.

Electronics Installation and Maintenance Book (EIMB), Test Methods and Practices, NAVSEA 0967-LP-000-0130, Naval Sea Systems Command, Washington, D.C., 1980.

Electronics Installation and Maintenance Book (EIMB), Reference Data, Naval Sea Systems Command, Washington, D.C., NAVSHIPS 0967-000-0140, 1972.

Electronics Installation and Maintenance Book (EIMB), General Maintenance, Naval Sea Systems Command, Washington, D.C., NAVSEA SE000-00-EIM-160, 1981.

Fiber Optic Symbols, *Military Standard MIL-STD-1864, Department of Defense, Washington, D.C., 1991.*

Fuses, Fuseholders, and Associated Hardware, Selection and Use of, *Military Standard MIL-STD-1360A, Department of Defense, Washington, D.C., 1979.*

Glossary of Telecommunication Terms, *Federal Standard 1037A, General Services Administration, Washington, D.C., 1986.*

I C Electrician 3, *Naval Education and Training Professional Development and Technology Center, Pensacola, Fla., NAVEDTRA 10059-A, 1989.*

Installation Practices-Aircraft Electric and Electronic Wiring, *NAVAIR 01-1A-505, Naval Air Systems Command, Washington, D.C., 1988.*

Installation Standards and Practices, NAVEXLEX 0280-LP-900-8000, 1977.

Insulation Sleeving, Electrical, Heat-Shrinkable, Polyolefin, Dual-Wall, Outer Wall Crosslinked, Military Specification MIL-I-23053/4C, Department of Defense, Washington, D.C., 1988.

Insulation Sleeving, Electrical, Heat-Shrinkable, Polyolefin, Flexible, Crosslinked, Military Specification MIL-I-23053/5B, Washington, D.C., 1986.

Linear Integrated Circuits Study Booklet, Module 34, CNTT-E-056, 1981.

List of Standard Microcircuits, *Military Standard MIL-STD-1562V, Department of Defense, Washington, D.C., 1991.*

Microcircuits, General Specification for, *Military Specification MIL-M-38510H, Department of Defense, Washington, D.C., 1990.*

Naval Oceanography Command Instruction 3144.1C, 1983.

Naval Ships' Technical Manual (NSTM), Stowage, Handling, and Disposal of Hazardous General Use Consumables, Chapter 670, NAVSEA S9086-WK-STM-010, Naval Sea Systems Command, Washington, D.C., 1987.

NEETS, Module 1, Introduction to Matter, Energy, and Direct Current, NAVEDTRA 172-01-00-88, Naval Education and Training Professional Development and Technology Center, Pensacola, Fla., 1988.

NEETS, Module 2, Introduction to Alternating Current and Transformers, NAVEDTRA 172-02-00-91, Naval Education and Training Professional Development and Technology Center, Pensacola, Fla., 1991.

NEETS, Module 3, Introduction to Circuit Protection, Control, and Measurement, NAVEDTRA 172-03-00-85, Naval Education and Training Professional Development and Technology Center, Fla., 1995.

NEETS, Module 4, Introduction to Electrical Conductors, Wiring Techniques, and Schematic Reading, NAVEDTRA 172-04-00-85, Naval Education and Training Professional Development and Technology Center, Pensacola, Fla., 1985.

NEETS, Module 5, Introduction to Generators and Motors, NAVEDTRA 172-05-00-79, Naval Education and Training Professional Development and Technology Center, Pensacola, Fla., 1979.

NEETS, Module 6, Introduction to Electronic Emission, Tubes, and Power Supplies, NAVEDTRA 172-06-00-82, Naval Education and Training Professional Development and Technology Center, Pensacola, Fla., 1982.

NEETS, Module 7, Introduction to Solid-State Devices and Power Supplies, NAVEDTRA 172-07-00-82, Naval Education and Training Professional Development and Technology Center, Pensacola, Fla., 1982.

NEETS, Module 8, Introduction to Amplifiers, NAVEDTRA 172-08-00-82, Naval Education and Training Professional Development and Technology Center, Pensacola, Fla., 1982.

NEETS, Module 9, Introduction to Wave Generation and Wave-Shaping Circuits, NAVEDTRA 172-09-00-83, Naval Education and Training Professional Development and Technology Center, Pensacola, Fla., 1983.

NEETS, Module 13, Introduction to Number Systems, Boolean Algebra, and Logic Circuits, NAVEDTRA 172-13-00-86, Naval Education and Training Professional Development and Technology Center, Pensacola, Fla., 1986.

NEETS, Module 18, Radar Principles, NAVEDTRA 172-18-00-84, Naval Education and Training Professional Development and Technology Center, Pensacola, Fla., 1984.

Resistors, Selection and Use of, Military Standard MIL-STD-199E, Department of Defense, Washington, D.C., 1991.

Rf Transmission Lines and Fittings, MIL-HDBK-216, Department of Defense, Washington, D.C., 1962.

Shipboard Electronic Material Officer, NAVEDTRA 10478-A1, Naval Education and Training Professional Development and Technology Center, Pensacola, Fla., 1982.

Standard General Requirements for Electronics Equipment, Military Standard MIL-STD-454M, Department of Defense, Washington, D.C., 1989.

