

★

NAVSHIPS 91271

INSTRUCTION BOOK

for

POWER SUPPLY

PP-380/U

FEDERAL TELEPHONE AND RADIO CORPORATION
EAST NEWARK, NEW JERSEY

NAVY DEPARTMENT

BUREAU OF SHIPS

★

Contract: NObsr 42510

Approved by BuShips: 16 November 1949

LIST OF EFFECTIVE PAGES

PAGE NUMBERS	CHANGE IN EFFECT	PAGE NUMBERS	CHANGE IN EFFECT
Title page	Original	2-0 to 2-1	Original
A to C	Original	3-0 to 3-3	Original
i to iii	Original	4-0 to 4-8	Original
1-0 to 1-3	Original	5-1 to 5-8	Original



NAVY DEPARTMENT
BUREAU OF SHIPS
WASHINGTON 25, D. C.

16 November 1949

ADDRESS NAVY DEPARTMENT
BUREAU OF SHIPS

REFER TO FILE NO.

Code-993-100

To: All Activities Concerned with the
Installation, Operation and Maintenance
of the Subject Equipment.

Subj: Instruction Book for Power Supply PP-380/U
(NAVSHIPS 91271).

1. NAVSHIPS 91271 is the instruction book for the subject equipment and is in effect upon receipt.
2. When superseded by a later edition, this publication shall be destroyed.
3. Extracts from this publication may be made to facilitate the preparation of other Navy instruction books and handbooks.
4. All requests for NAVSHIPS Electronics publications should be directed to the nearest District Publications and Printing Office. When changes or revised books are distributed notice will be included in the applicable maintenance bulletin and the BUSHIPS ELECTRON.

D. H. CLARK
Chief of Bureau

FROM BUREAU OF SHIPS

TABLE OF CONTENTS

SECTION 1—GENERAL DESCRIPTION		SECTION 3—INSTALLATION AND OPERATION	
<i>Paragraph</i>	<i>Page</i>	<i>Paragraph</i>	<i>Page</i>
1. Purpose and Basic Principles	1-1	1. Unpacking Procedure	3-1
2. Description of PP-380/U	1-1	2. Installation and Operation	3-1
3. Reference Data	1-1	3. Cable Fabrication	3-2
 SECTION 2—THEORY OF OPERATION		 SECTION 4—MAINTENANCE	
1. Introduction	2-0	1. Introduction	4-1
2. Functional Circuits of PP-380/U	2-0	2. Trouble Shooting	4-1
3. Functional Use of PP-380/U	2-0	3. Repair Procedures	4-1
		 SECTION 5—PARTS LISTS	

LIST OF ILLUSTRATIONS

SECTION 1—GENERAL DESCRIPTION			SECTION 4—MAINTENANCE		
<i>Figure</i>	<i>Title</i>	<i>Page</i>	<i>Figure</i>	<i>Title</i>	<i>Page</i>
1-1	Power Supply PP-380/U and Accessories	1-0	4-1	Trouble Shooting Chart	4-2
 SECTION 2—THEORY OF OPERATION			4-2	Power Supply PP-380/U, Parts Identification	4-3
2-1	Power Supply PP-380/U, Block Diagram	2-1	4-3	Power Supply PP-380/U, Schematic Diagram	4-4
2-2	Relay Circuit	2-1	4-4	Power Supply PP-380/U, Practical Wiring Diagram of Chassis Bottom	4-5
 SECTION 3—INSTALLATION AND OPERATION			4-5	Power Supply PP-380/U, Practical Wiring Diagram of Chassis Top	4-6
3-1	Unpacking Procedure	3-0	4-6	Power Supply PP-380/U, Voltage and Resistance Data	4-7
3-2	Power Supply PP-380/U, Outline Drawing	3-2			
3-3	Cable Fabrication	3-3			

LIST OF TABLES

SECTION 1—GENERAL DESCRIPTION		SECTION 4—MAINTENANCE				
<i>Table</i>	<i>Page</i>	<i>Table</i>	<i>Page</i>			
1-1	Equipment Supplied	1-2	4-1	Winding Data	4-8	
1-2	Equipment and Publications Required But Not Supplied	1-2				
1-3	Shipping Data	1-3				
1-4	Basic Similarities in TCS- Series Power Supplies	1-3				
1-5	Electron Tube Complement	1-3				
 SECTION 3—INSTALLATION AND OPERATION		 SECTION 5—PARTS LISTS				
3-1	Input Voltage Adjustments	3-1	5-1	List of Major Units	5-1	
				5-2	Maintenance Parts List	5-2
				5-3	Cross Reference Parts List	5-6
				5-4	Color Codes and Miscellaneous Data	5-7
				5-5	List of Manufacturers	5-8

INSTALLATION RECORD

Contract Number NObsr-42510	Date of Contract 30 June 1948
Serial Number of Equipment.....	
Date of acceptance by the Navy.....	
Date of delivery to contract destination.....	
Date of completion of installation.....	
Date placed in service.....	

Blank spaces on this page shall be filled in at the time of installation. Operating personnel shall also mark the "date placed in service" on the date of acceptance plate located below the model nameplate on the equipment, using suitable methods and care to avoid damaging the equipment.

SAFETY NOTICE

The attention of officers and operating personnel is directed to Chapter 67 of the *Bureau of Ships Manual* or superseding instructions on the subject of radio-safety precautions to be observed.

This equipment employs voltages which are dangerous and may be fatal if contacted by operating personnel. Extreme caution should be exercised when working with the equipment.

While every practicable safety precaution has been incorporated in this equipment, the following rules must be strictly observed:

KEEP AWAY FROM LIVE CIRCUITS:

Operating personnel must at all times observe all safety regulations. Do not change tubes or make adjustments inside equipment with the high voltage supply on. Under certain conditions dangerous potentials may exist in circuits with power controls in the off position due to charges retained by capacitors. To avoid casualties always remove power and discharge and ground circuits prior to touching them.

DON'T SERVICE OR ADJUST ALONE:

Under no circumstances should any person reach within or enter the enclosure for the purpose of servicing or adjusting the equipment without the immediate presence or assistance of another person capable of rendering aid.

DON'T TAMPER WITH INTERLOCKS:

Do not depend upon door switches or interlocks for protection but always shut down motor generators or other power equipment. Under no circumstances should any access gate, door, or safety interlock switch be removed, short-circuited, or tampered with in any way, by other than authorized maintenance personnel, nor should reliance be placed upon the interlock switches for removing voltages from the equipment.

RESUSCITATION

AN APPROVED POSTER ILLUSTRATING THE RULES FOR RESUSCITATION BY THE PRONE PRESSURE METHOD SHALL BE PROMINENTLY DISPLAYED IN EACH RADIO, RADAR, OR SONAR ENCLOSURE. POSTERS MAY BE OBTAINED UPON REQUEST TO THE BUREAU OF MEDICINE AND SURGERY.

GUARANTEE

The equipment, including all parts and spare parts, except vacuum tubes, batteries, rubber and material normally consumed in operation, is guaranteed for a period of one year from the date of delivery of the equipment to and acceptance by the Government with the understanding that all such items found to be defective as to material, workmanship or manufacture will be repaired and replaced, f.o.b. any point within the continental limits of the United States designated by the Government, without delay and at no expense to the Government; provided that such guarantee will not obligate the Contractor to make repair or replacement of any such defective items unless the defect appears within the aforementioned period and the Contractor is notified thereof in writing within a reasonable time and the defect is not the result of normal expected shelf life deterioration.

To the extent the equipment, including all parts and spare parts, as defined above, is of the Contractor's design or is of a design selected by the Contractor, it is also guaranteed, subject to the foregoing conditions, against defects in design with the understanding that if ten percent (10%) or more of any such item, but not less than two of any such item, of the total quantity comprising such item furnished under said contract, are found to be defective as to design, such item will be conclusively presumed to be of defective design and subject to one hundred percent (100%) correction or replacement by a suitably redesigned item.

All such defective items will be subject to ultimate return to the Contractor. In view of the fact that normal activities of the Naval Service may result in the use of equipment in such remote portions of the world or under such conditions as to preclude the return of the defective items for repair or replacement without jeopardizing the integrity of Naval communications, the exigencies of the Service, therefore, may necessitate expeditious repair of such items in order to prevent extended interruption of communications. In such cases the return of the defective items for examination by the Contractor prior to repair or replacement will not be mandatory. The report of a responsible authority, including details of the conditions surrounding the failure, will be acceptable as a basis for affecting expeditious adjustment under the provision of this contractual guarantee.

The above one year period will not include any portion of time the equipment fails to perform satisfactorily due to any defects, and any items repaired or replaced by the Contractor will be guaranteed anew under this provision.

REPORT OF FAILURE

Report of failure of any part of this equipment, during its entire service life, shall be made to the Bureau of Ships in accordance with current regulations using form NAVSHIPS NBS 383 (revised). The report shall cover all details of the failure and give the date of installation of the equipment. For procedure in reporting failures see Chapter 67 of the *Bureau of Ships Manual* or superseding instructions.

ORDERING PARTS

All requests or requisitions for replacement material should include the following data:

1. Standard Navy stock number or, when ordering from a Marine Corps or Signal Corps supply depot, the Signal Corps stock number.
2. Name and short description of part.

If the appropriate stock number is not available the following shall be specified:

1. Equipment model or type designation, circuit symbol, and item number.
2. Name of part and complete description.
3. Manufacturer's designation.
4. Contractor's drawing and part number.
5. JAN or Navy type number.

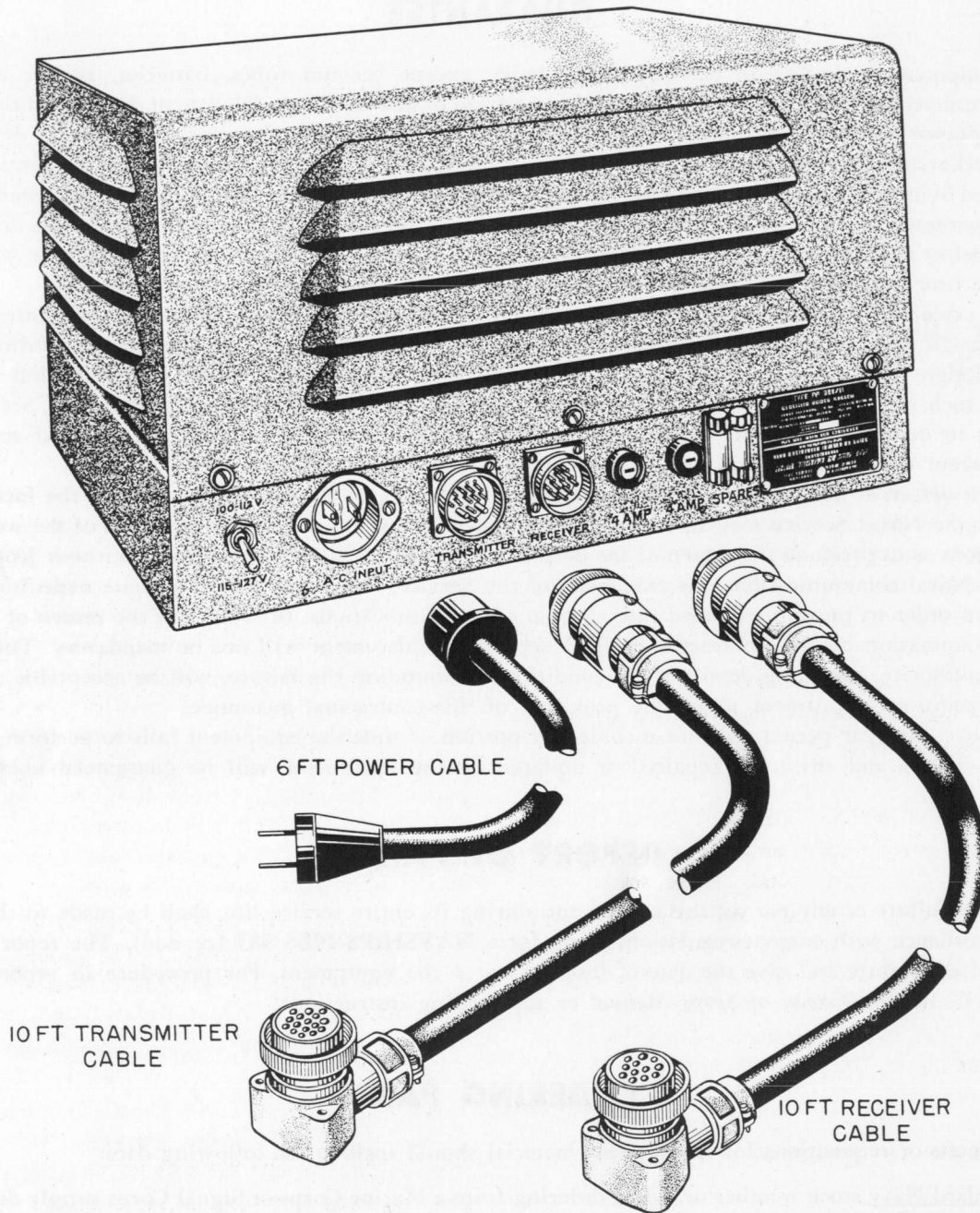

Figure 1-1. Power Supply PP-380/U and Accessories

SECTION 1

GENERAL DESCRIPTION

1. PURPOSE AND BASIC PRINCIPLES.

(See Figure 1-1.)

a. PURPOSE OF THE EQUIPMENT.—Power Supply PP-380/U is an electronic-type power supply primarily intended for use with the Navy Model TCS series Radio, Telephone and Telegraph Transmitting and Receiving Equipment, except there are no provisions for remote control of the equipment. However, the power supply may be used for other equipments that have similar power supply requirements.

Note

Power Supply PP-380/U is designed for non-shipboard uses only.

b. BASIC PRINCIPLES. — PP-380/U is an AC-operated electronic power supply employing electron tube rectification for the high voltage plate supply and dry disc rectification for the low voltage supply. Conventional power supply circuitry is used.

c. NOMINAL RATINGS.—The nominal ratings of PP-380/U are: Input, 115 volts 60 CPS 1 phase. Outputs, 400 volts DC at 0.25 amperes; 225 volts DC at 0.12 amperes; 12 volts DC at 1.225 amperes; 12.6 volts AC at 3.90 amperes.

2. DESCRIPTION OF PP-380/U.

(See Figure 1-1.)

a. POWER SUPPLY PP-380/U. — Power Supply PP-380/U comprises a chassis and a cover, both constructed of sheet steel and finished with black wrinkle enamel. The cover has ventilating louvers on all four sides and is secured to the chassis with six screws. The chassis mounts all of the components comprising the power supply. The front apron of the chassis is used as a connection panel and mounts a voltage adjustment switch, three connectors, two fuses, and a spare fuse holder. Since PP-380/U is designed for non-shipboard uses, no provision is made for permanent mounting of it. The nominal ratings of PP-380/U are identical with

those of the shipboard-type power supplies for the TCS-series, but PP-380/U does not have facilities for the use of the remote control unit furnished with TCS-series equipments.

b. ACCESSORIES. — Three cables are furnished with PP-380/U, an AC power cable, a TRANSMITTER power cable, and a RECEIVER power cable. The AC power cable has two conductors and terminates in a parallel blade male plug and a female connector that mates with the A-C POWER connector on PP-380/U. The TRANSMITTER power cable has eleven conductors and terminates in two 16-contact connectors. One connector is straight and the other is angled at 90° to the cable. The RECEIVER power cable has seven conductors and terminates in two 12-contact connectors. Its connectors are straight- and angle-type, like the TRANSMITTER power cable. The TRANSMITTER and RECEIVER power cables connect from PP-380/U to the like-named TCS units.

3. REFERENCE DATA.

a. NOMENCLATURE. Power Supply PP-380/U.

b. CONTRACT. NObsr-42510 dated 30 June 1948.

c. CONTRACTOR. Federal Telephone and Radio Corp.

900 Passaic Avenue

East Newark, New Jersey.

d. COGNIZANT NAVAL INSPECTOR. Inspector of Naval Material, Newark, New Jersey.

e. NUMBER OF PACKAGES PER SHIPMENT. One.

f. TOTAL CUBICAL CONTENTS.

(1) CRATED. 3 cubic feet.

(2) UNCRATED. 1.1 cubic feet.

g. TOTAL WEIGHT.

(1) CRATED. 70 pounds.

(2) UNCRATED. 62.5 pounds.

b. NOMINAL RATINGS.

(1) AC POWER INPUT. 115 volts, 60 cycles, 1 phase, 275 watts.

- (2) OUTPUTS.
- a. 400 volts DC at 0.20 amperes.
 - b. 225 volts DC at 0.12 amperes.
 - c. 12 volts DC at 1.225 amperes.
 - d. 12.6 volts AC at 3.90 amperes.

i. AC POWER INPUT VOLTAGE ADJUSTMENT RANGE.

(1) MANUAL. Two positions: 100-112 and 115-127 volts.

(2) INTERNAL. Five taps on each power transformer.

j. HEAT DISSIPATION. 105 watts.

TABLE 1-1. EQUIPMENT SUPPLIED

QUAN- TITY PER EQUIP- MENT	NAME OF UNIT	OVERALL DIMENSIONS, INCHES			VOL- UME CU. FT.	WEIGHT POUNDS
		HEIGHT	WIDTH	DEPTH		
1	Power Supply PP-380/U	9½	17¾	12¾	1.1	57
1	AC POWER Input Cable (6' 0")	—	—	—	—	0.5
1	Transmitter Power Cable (10' 0")	—	—	—	—	2.1
1	Receiver Power Cable (10' 0")	—	—	—	—	1.9
2	Instruction Books	—	—	—	—	1.0

TABLE 1-2. EQUIPMENT AND PUBLICATIONS REQUIRED BUT NOT SUPPLIED

QUAN- TITY PER EQUIP- MENT	NAME OF UNIT	NAVY TYPE DESIGNA- TION	REQUIRED USE	REQUIRED CHARACTERISTICS
1	Navy Model TCS series Radio, Telephone and Tele- graph Transmitting and Receiving Equipment	TCS-1 thru TCS-15	Communication	All TCS- series equip- ments can be powered by PP-380/U
2	Instruction Books	Applicable NAVSHIPS publication	—	—

TABLE 1-3. SHIPPING DATA

SHIP- PING BOX NO.	CONTENTS	OVERALL DIMENSIONS, INCHES			VOL- UME CU. FT.	WEIGHT POUNDS
		HEIGHT	WIDTH	DEPTH		
1	Power Supply PP-380/U AC Power Input Cable Transmitter Power Cable Receiver Power Cable Instruction Books	14 $\frac{1}{4}$	17 $\frac{3}{4}$	21 $\frac{7}{8}$	3	70

TABLE 1-4. BASIC SIMILARITIES IN TCS- SERIES POWER SUPPLIES

DESIG- NATION	NOMINAL LINE VOLTAGE	USE	MECHANICAL DESIGN	REMARKS
PP-380/U	115	Non-shipboard only	No provision for permanent mounting	Cannot use remote control unit of TCS-
-20218	115	Shipboard	Provision for permanent mounting	Can use remote control unit of TCS-
-20309	115/230	Shipboard	Provision for permanent mounting	Can use remote control unit of TCS-

TABLE 1-5. ELECTRON TUBE COMPLEMENT

QUAN- TITY	JAN TYPE	DESCRIPTION	SYMBOL NUMBERS INVOLVED	REMARKS
1	5U4G	Full-wave high-vacuum rectifier	V-305	Army Type VT-244
2	6X5GT	Full-wave high-vacuum rectifier	V-306 V-307	Cannot be replaced with metal 6X5

SECTION 2

THEORY OF OPERATION

1. INTRODUCTION.

(See Figure 2-1.)

Power Supply PP-380/U is primarily intended for use with TCS- series equipments where remote control operation is not required. PP-380/U is not suitable for shipboard use.

PP-380/U uses conventional power supply circuits to obtain three values of DC voltage, 400, 225, and 12 volts. It also delivers 12.6 volts AC.

2. FUNCTIONAL CIRCUITS OF PP-380/U.

(See Figures 2-1 and 2-2.)

a. GENERAL.—PP-380/U employs three full-wave rectifier circuits to supply its three DC outputs. The AC output is obtained from a step-down winding on the 225 volt DC supply power transformer. The operation of the 225 DC, 12 DC, and 12.6 volt AC supplies are controlled by the POWER switch on the TCS receiver, and the operation of the 400 volt DC supply is controlled by the POWER switch on the TCS transmitter.

b. 225 VOLT DC SUPPLY CIRCUITS.—The 225 volt DC receiver supply uses transformer T-306, which supplies plate and heater power to the full-wave 6X5GT rectifiers V-306 and V-307. In addition, T-306 supplies power for the 12 volt DC and the 12.6 volt AC supplies. The DC output of V-306 and V-307 is applied to a *pi*-type filter consisting of L-306, C-311, and C-312, which attenuates the 120-cycle ripple normally present in the output of a 60-cycle operated full-wave rectifier. The 120-cycle ripple is further attenuated by capacitor C-313 across L-306, which resonates L-306 in the region of the ripple frequency and hence reduces the ripple component in the DC output. A bleeder resistor R-306 is connected across the filter input. (See Figure 4-4.)

c. 400 VOLT DC SUPPLY CIRCUITS.—The 400 volt DC transmitter supply can function only when relay K-302 is actuated by the closure of the POWER switch in the TCS transmitter, *after* the TCS receiver

has been put in operation. With K-302 actuated, AC power is applied to transformer T-305 through one pair of contacts on K-302. T-305 supplies plate and filament power to the full-wave 5U4G rectifier V-305. The DC output of V-305 is applied to a *pi*-type filter similar to that used in the 225 volt supply. The components of this filter are L-305, C-308, and C-309. C-310 is paralleled across L-305, and R-305 serves as the bleeder resistor.

d. 12 VOLT DC SUPPLY CIRCUITS.—The 12 volt DC supply obtains power from a secondary of T-306, which is applied to the selenium rectifier CR-302. The DC output of CR-302 is supplied directly to the relays in the TCS transmitter.

e. 12.6 VOLT AC SUPPLY CIRCUITS.—The 12.6 volt AC supply also obtains power from a secondary of T-306. This supply feeds directly to the TCS receiver and also passes through a pair of K-302 relay contacts to the TCS transmitter. The 12.6 volt secondary of T-306 also supplies the series-connected heaters of V-306 and V-307.

3. FUNCTIONAL USE OF PP-380/U.

(See Figures 1-1 and 4-4.)

a. CONNECTIONS TO TCS EQUIPMENT.—The transmitter power cable supplied with PP-380/U connects from the TRANSMITTER connector on PP-380/U to the POWER CONNECTOR on the TCS transmitter. The receiver power cable supplied with PP-380/U connects from the RECEIVER connector on PP-380/U to the POWER CONNECTOR on the TCS receiver. The TCS remote control unit is not used with PP-380/U.

b. CONNECTION TO AC POWER.—The AC power input cable connects from the A-C INPUT connector on PP-380/U to any convenient source of 115 volts AC; single phase.

c. PP-380/U OPERATION.—Closure of the POWER switch on the TCS receiver puts the 225 DC, 12 DC, and 12.6 volt AC supplies in operation, feeding the

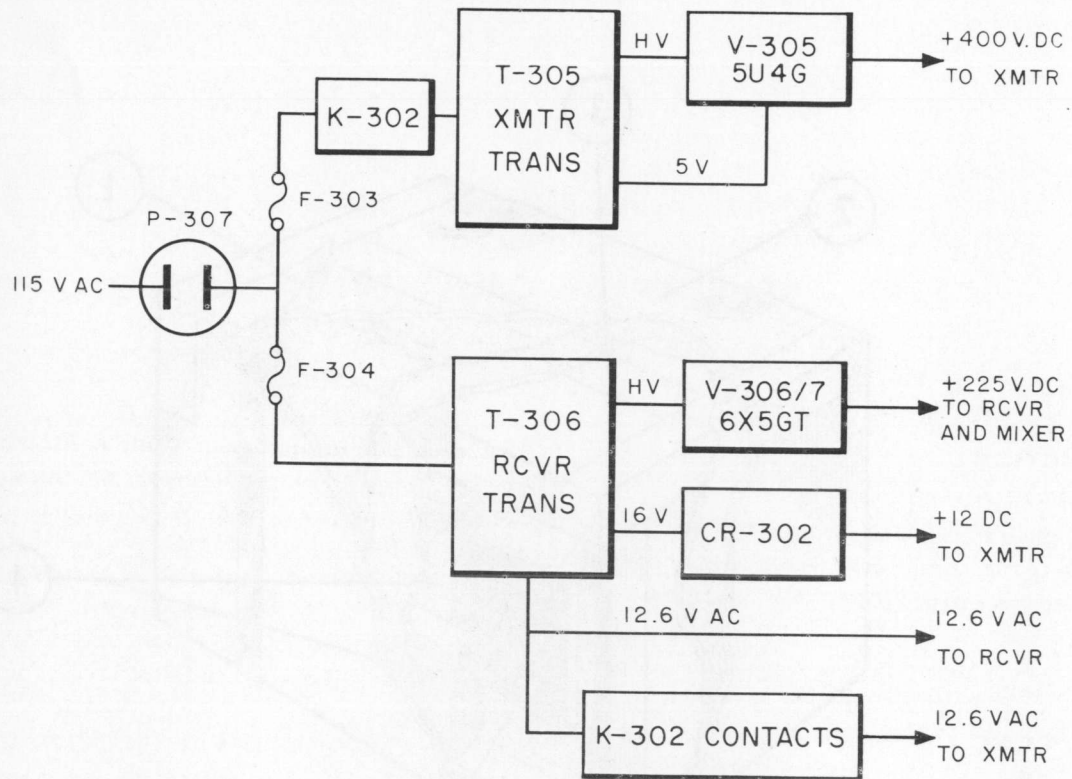

Figure 2-1. Power Supply PP-380/U, Block Diagram

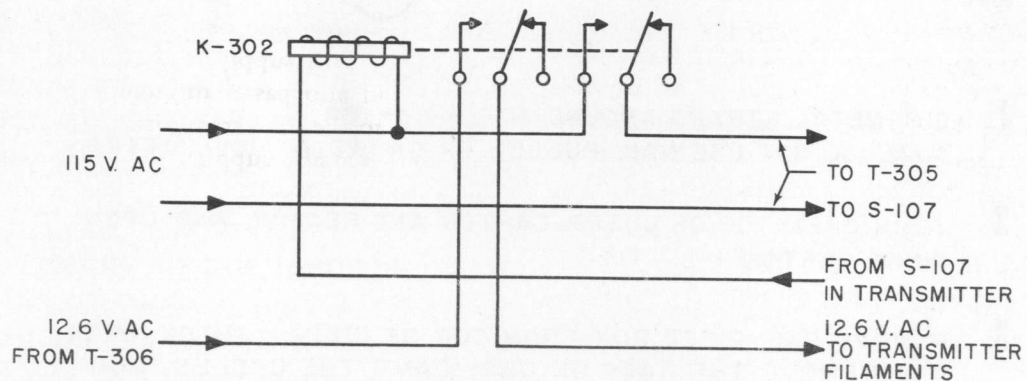

Figure 2-2. Relay Circuit

TCS receiver with all operating voltages. In addition, the 12 volt DC supply is applied to the relays in the TCS transmitter. The TCS receiver can be operated at this time.

Closure of the POWER switch on the TCS transmitter actuates the relay K-302 in PP-380/U, thus applying AC power to the 400 volt transmitter supply. A pair of contacts on K-302 closes the circuit for the 12.6 volt AC supply to the TCS transmitter, as well. This supplies all operating voltages to the TCS trans-

mitter. For CW operation the TCS receiver is disabled only when the key is down, and for VOICE operation the receiver is disabled only when the press-to-talk button on the microphone is down.

PP-380/U is protected by two power line fuses. F-304 is in the primary circuit of transformer T-306 and protects the 225 DC, 12 DC and 12.6 volt AC supplies. F-303 is in the primary circuit of T-305 and protects the 400 volt transmitter supply only.

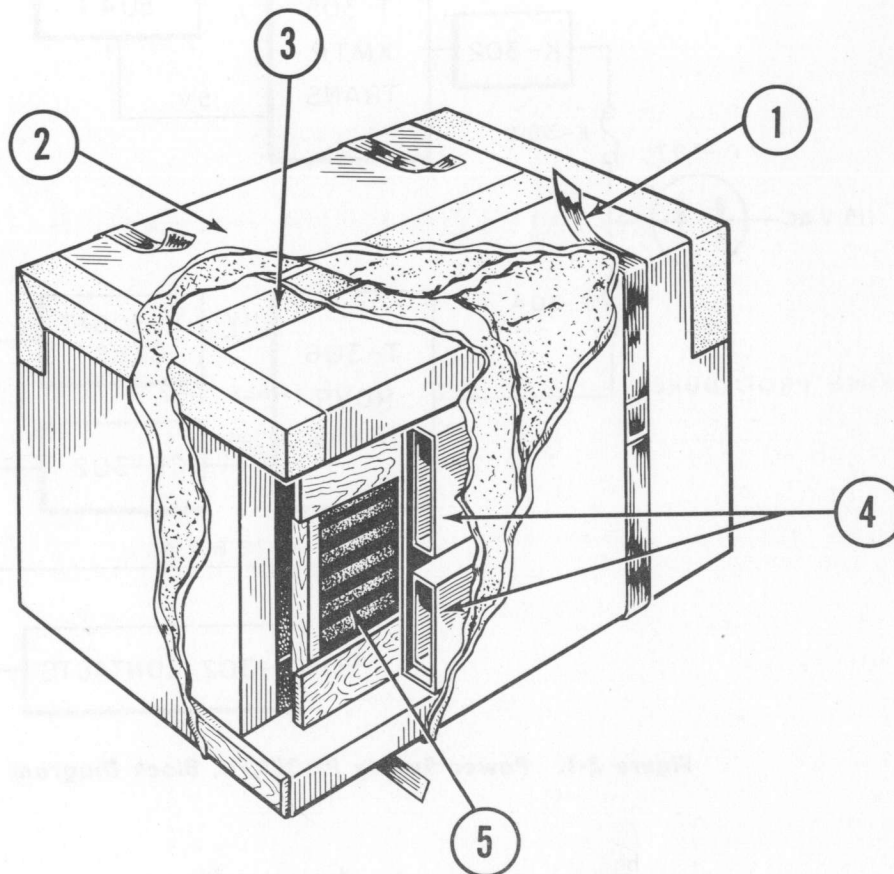

- 1 CUT METAL STRAPS AROUND OUTER CARTON
NOTE DO NOT USE NAIL PULLER OR CROWBAR. USE CUTTERS.
- 2 TEAR OPEN TOP OF OUTER CARTON AND REMOVE AND OPEN INNER CARTON.
- 3 REMOVE ONE-PIECE BOX FROM TOP OF INNER CARTON, OPEN, AND REMOVE THE BAGS OF DESSICANT, THE CABLES, AND THE INSTRUCTION BOOKS.
- 4 REMOVE THE CORRUGATED END CELLS AND THE WOODEN PROTECTOR. THEN REMOVE THE CORRUGATED SIDE CELLS.
- 5 REMOVE POWER SUPPLY FROM CARTON

Figure 3-1. Unpacking Procedure

SECTION 3

INSTALLATION AND OPERATION

1. UNPACKING PROCEDURE.

(See Figure 3-1.)

To unpack Power Supply PP-380/U, proceed as follows:

Step 1. Cut the two metal straps around the outer carton, using wire or bolt cutters.

Note

Do not use a nail puller or a crowbar to break the straps.

Step 2. Tear open the top of the outer carton, tear open the vaporproof barrier and remove the inner carton. Open the inner carton.

Step 3. Remove the one-piece box from the top of the inner carton and open it. Remove the bags of desiccant, the three cables, and the two instruction books from the box.

Step 4. Remove the corrugated end cells from the carton, then remove the wooden protector from the top of the power supply. Remove the remaining corrugated cells at the sides of the carton.

Step 5. Remove Power Supply PP-380/U from the carton.

2. INSTALLATION AND OPERATION.

(See Figure 3-2.)

a. INPUT VOLTAGE ADJUSTMENT.—A two-position switch S-302 is provided for rough voltage adjustments and five taps are provided on each power transformer for fine voltage adjustments. As shipped, PP-380/U is wired for 115 volt operation. To adjust for other line voltages between 100 and 130 volts, remove the cover from PP-380/U and shift the leads from terminal 3 on T-305 and terminal 4 on T-306 to the applicable terminals listed in Table 3-1.

b. INSTALLATION.—No provision is made for permanent mounting of PP-380/U since this unit is intended for non-shipboard use. It may be placed approximately ten feet from the TCS transmitter and receiver

TABLE 3-1. INPUT VOLTAGE ADJUSTMENTS

Line Volts		Set S-302 at		Transformer Terminal	
More Than	Less Than	100-112	115-127	T-305	T-306
100	103	x		3	2
103	106	x		4	2
106	109	x		5	3
109	112	x		6	3
112	115	x		7	4
115	118		x	3	4 (As shipped)
118	121		x	4	5
121	124		x	5	5
124	127		x	6	6
127	130		x	7	6

After adjusting for line voltage, replace the cover on PP-380/U.

in any direction. The only limitation on PP-380/U placement is the length of the transmitter and receiver power cables. Of course, the AC power input cable must reach a nearby power outlet as well. The transmitter and receiver power cables can be connected with either the angle or straight connectors at the power supply, as desired.

Note

Be sure that S-302 is set at the proper position for the prevailing line voltage, as shown in Table 3-1.

After determining the location for PP-380/U, connect the transmitter power cable from the TRANSMITTER connector on PP-380/U to the POWER CONNECTOR on the TCS transmitter. Connect the receiver power cable from the RECEIVER connector on PP-380/U to the POWER CONNECTOR on the TCS receiver. Connect the AC power input cable from the A-C INPUT connector on PP-380/U to a nearby power outlet. The equipment is now ready for operation.

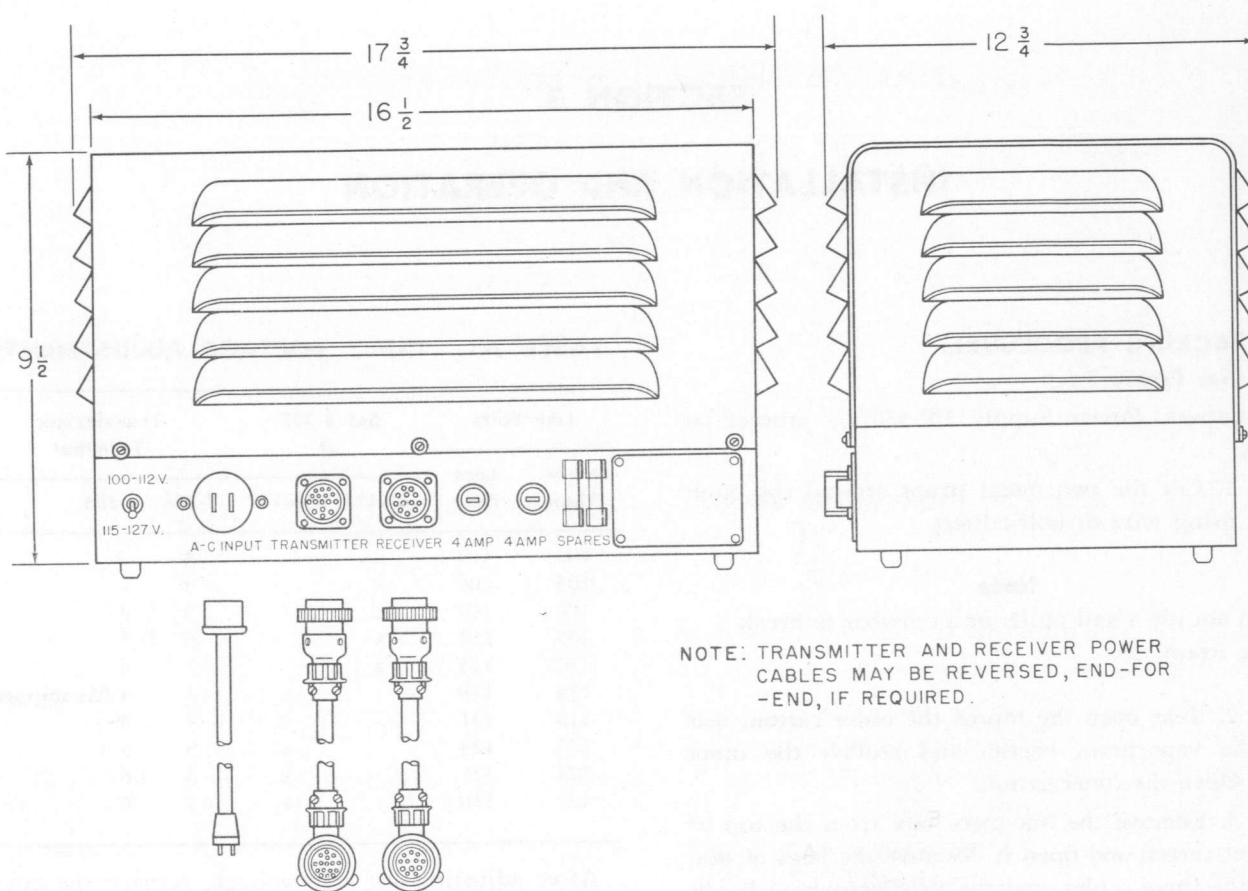

NOTE: TRANSMITTER AND RECEIVER POWER
CABLES MAY BE REVERSED, END-FOR-
-END, IF REQUIRED.

Figure 3-2. Power Supply PP-380/U, Outline Drawing

c. OPERATION.—PP-380/U is operated from the TCS receiver and transmitter. Therefore no operating instructions are given here. Refer to the applicable publication for the particular TCS equipment in use.

3. CABLE FABRICATION.

(See Figure 3-3.)

Fabrication data for the AC input power, transmitter power, and receiver power cables are given in Figure 3-3. For other details see Section 5, Parts Lists.

Note

The AC input power cable may be fabricated to lengths greater than six feet, if desired. Do not lengthen either the transmitter or receiver power cables without specific authorization.

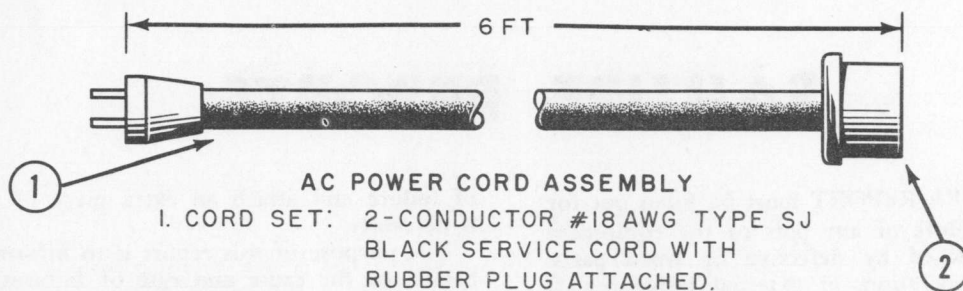

AC POWER CORD ASSEMBLY

1. CORD SET: 2-CONDUCTOR #18 AWG TYPE SJ BLACK SERVICE CORD WITH RUBBER PLUG ATTACHED.
2. CONNECTOR: FEMALE, AMPHENOL 61F4 OR EQUAL.

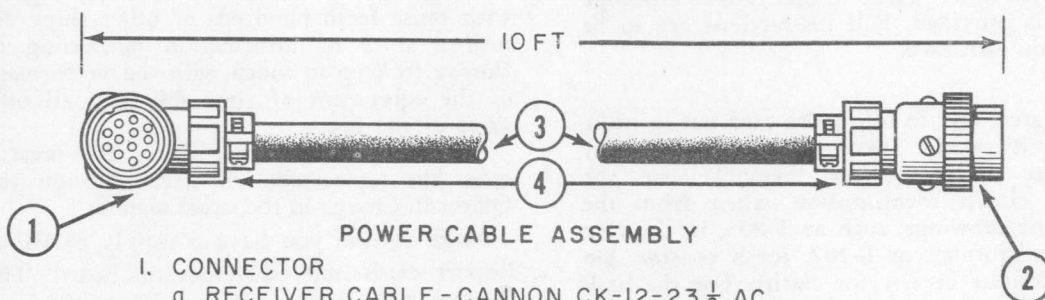

POWER CABLE ASSEMBLY

1. CONNECTOR
 - a. RECEIVER CABLE-CANNON CK-12-23 1/2 AC
 - b. TRANSMITTER CABLE-CANNON SK-C16-23 1/2 AC
2. CONNECTOR
 - a. RECEIVER CABLE-CANNON CK-12-21 1/2 AC
 - b. TRANSMITTER CABLE-CANNON SK-C16-21 1/2 AC
3. CABLE:
 - a. RECEIVER CABLE-SEVEN CONDUCTOR CABLE
 - b. TRANSMITTER CABLE-ELEVEN CONDUCTOR CABLE
4. CABLE CLAMP: AN-3057-8

RECEIVER CABLE		CONNECTOR PIN	TRANSMITTER CABLE	
WIRE SIZE	WIRE COLOR		WIRE SIZE	WIRE COLOR
20	RED	2	20	RED
20	ORANGE	3	—	—
—	—	4	20	BLACK
16	BROWN	5	—	—
14	BLACK	6	—	—
—	—	7	16	WHITE
12	BLUE	8	20	BROWN
20	BLUE	9	20	BLUE
12	ORANGE	10	—	—
JUMPER TO PIN 8		11	20	ORANGE
NOT USED		12	16	ORANGE
		13	16	BROWN
		14	20	RED
		15	14	BLACK
		16	20	GREEN

Figure 3-3. Cable Fabrication

FAILURE REPORTS

A FAILURE REPORT must be filled out for the failure of any part of the equipment whether caused by defective or worn parts, improper operation, or external influences. It should be made on Failure Report, form NBS-383, which has been designed to simplify this requirement. The card must be filled out and forwarded to BUSHIPS in the franked envelope which is provided. Full instructions are to be found on each card.

Use great care in filling the card out to make certain it carries adequate information. For example, under "Circuit Symbol" use the proper circuit identification taken from the schematic drawings, such as T-803, in the case of a transformer, or R-207, for a resistor. Do not substitute brevity for clarity. Use the back of the card to completely describe the cause

of failure and attach an extra piece of paper if necessary.

The purpose of this report is to inform BUSHIPS of the cause and rate of failures. The information is used by the Bureau in the design of future equipment and in the maintenance of adequate supplies to keep the present equipment going. The cards you send in, together with those from hundreds of other ships, furnish a store of information permitting the Bureau to keep in touch with the performance of the equipment of your ship and all other ships of the Navy.

This report is not a requisition. You must request the replacement of parts through your Officer-in-Charge in the usual manner.

Make certain you have a supply of Failure Report cards and envelopes on board. They may be obtained from the nearest Publications and Printing Office.

FAILURE REPORT—ELECTRONIC EQUIPMENT
NAVSHIPS (NBS) 383 (REV. 8-45)
(FORMERLY NAVSHIPS (NBS) 381 AND NAVSHIPS (NBS) 384)
SHIP NUMBER AND NAME OR STATION _____

CHECK ONE: RADIO
EQUIPMENT MODEL DESIGNATION _____
TYPE NUMBER AND NAME OF MAJOR UNIT INVOLVED _____
THIS _____
TUBE TYPE, INCLUDING PREFIX LETTERS _____
TUBE MANUFACTURER _____
FAILURE OCCURRED IN:
 STORAGE OPERATION
 HANDLING OTHER (SPECIFY) _____
 INSTALLING
NATURE OF FAILURE AND REMARKS _____

NOTICE—Read notes on reverse side. Additional forms and envelopes may be obtained from nearest RMO.

NAME OF PERSON MAKING REPORT _____ DATE _____

ELECTRONIC EQUIPMENT FAILURE REPORT (SIG)
NAVSHIPS (NBS) 383 (REV. 11-45)

ORGANIZATION PERFORMING MAINTENANCE _____

EQUIPMENT INVOLVED:
 Navy Army USMC JAN Commercial Other _____ (Specify)
 Radio Radar Sensor Wire Test Power Sound Other _____ (Specify)

EQUIPMENT MODEL DESIGNATION _____ SERIAL NUMBER OF EQUIPMENT _____ NAME OF CONTRACTOR _____ CONTRACT NO. _____
TYPE NUMBER AND NAME OF MAJOR UNIT INVOLVED _____ SERIAL NUMBER OF UNIT _____ CONTRACT OR PO DATA OF UNIT _____ DATE EQUIPMENT RECEIVED _____

ITEM WHICH FAILED

THIS SIDE FOR TUBES		THIS SIDE FOR PARTS (NOTE 9)		
TUBE TYPE, INCLUDING PREFIX LETTERS _____	SERIAL NO. (NOTE 8) _____	NAME OF PART _____	CIRCUIT SYMBOL (E.G. R 134) _____	NAVY TYPE NO. _____
TUBE MANUFACTURER _____	CONTRACT NO. (NOTE 8) _____	SERIAL NO. _____	*CONTRACT DATA _____	*DATE RECD. _____
FAILURE OCCURRED IN: <input type="checkbox"/> Storage <input type="checkbox"/> Operation <input type="checkbox"/> Handling <input type="checkbox"/> Other (Specify in remarks) _____ <input type="checkbox"/> Installing	GUARANTEED HOURS (NOTE 8) _____ ACTUAL HOURS _____	DATE OF ACCEPTANCE (NOTE 8) _____ DATE OF FAILURE _____	*CHECK-OFF OR TAG DATA (NOTE 8) _____	*MANUFACTURER'S DATA (NOTE 8) _____
TYPE OF FAILURE (NOTE 7) _____		TUBE CIRCUIT SYMBOL V- _____		
BRIEF DESCRIPTION AND CAUSE OF FAILURE, INCLUDING APPROXIMATE LIFE (CONTINUE ON BACK)				

NATURE OF FAILURE AND REMARKS (NOTE 8) (CONTINUE ON BACK) _____

REPORT NO. _____ DATE _____

NAME AND RANK OF OFFICER ACCOUNTABLE FOR MAINTENANCE _____

CONCLUSION:
 Normal replacement Shortage Modification Failure Transportation damage Other _____ (Specify)

*NOT REQUIRED FOR REPORTS SUBMITTED BY NAVAL ACTIVITIES.

16-46681-1 U. S. GOVERNMENT PRINTING OFFICE

SECTION 4
MAINTENANCE**1. INTRODUCTION.**

Maintenance of Power Supply PP-380/U will be found to be relatively simple because of its simplicity and strong construction. Beyond the usual replacement of electron tubes and fuses, little or no maintenance should be required. Complete maintenance data is given in this section to aid maintenance personnel.

2. TROUBLE SHOOTING.

The first step in repairing faulty equipment consists of a visual check of its condition. Look for loose parts, defective wiring, evidence of mishandling, and similar readily detected faults. Often the cause of the trouble will be discovered in the course of this visual check.

The second step in repairing faulty equipment is a systematic examination of the operation of the equipment, as outlined in the Trouble Shooting Chart, Figure 4-1. This will usually locate the component at fault.

The third step, repair, will be aided by the data contained in this section. The repair should be followed by an operational check.

3. REPAIR PROCEDURES.

(See Figures 4-2 through 4-6.)

a. FUSE REPLACEMENT.—Use only 4 ampere 250 volt Type 3AG glass-enclosed fuses for the replacement of F-303 or F-304.

WARNING

Never replace a fuse with one of higher rating unless continued operation is more important than probable damage. If a fuse burns out immediately after replacement, do not replace it again until the cause is corrected.

Failure of F-303 will be evidenced by a lack of operating power at the TCS transmitter, and failure of F-304 will remove receiver power and part of transmitter power from the TCS equipment.

b. ELECTRON TUBE REPLACEMENT.—To enable the removal of any of the three tubes in PP-380/U, remove the equipment cover (see Section 3, paragraph 2a) and depress the tube clamp at the base of the tube. When replacing tubes, be sure that the tube clamp is holding the tube after the tube is inserted.

Note

ALL TUBES OF A GIVEN TYPE SUPPLIED WITH THE EQUIPMENT SHALL BE CONSUMED PRIOR TO THE EMPLOYMENT OF TUBES FROM GENERAL STOCK.

Note

The 6X5GT tubes used in PP-380/U cannot be replaced with metal 6X5 tubes because of differences in base dimensions.

c. SPECIFIC REPAIR PROCEDURES.—Because of the simplicity of PP-380/U construction, step-by-step replacement procedures are not required for its component parts. Figures 4-2 through 4-6 and Table 4-1 contain the data required for repair of the equipment, and the tables in Section 5, Parts Lists, supplement that data.

Note

Do not operate equipment with cover removed.

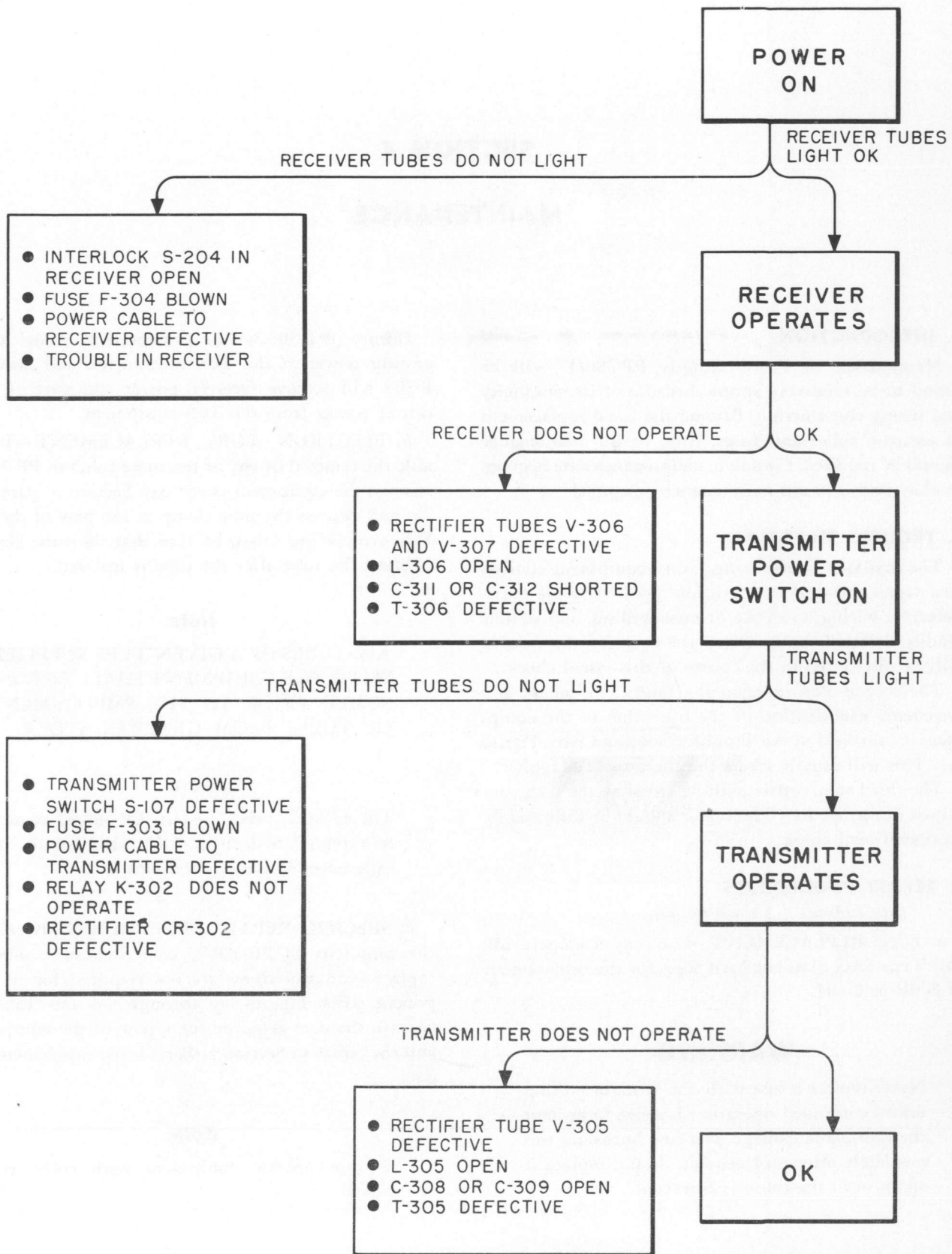

Figure 4-1. Trouble Shooting Chart

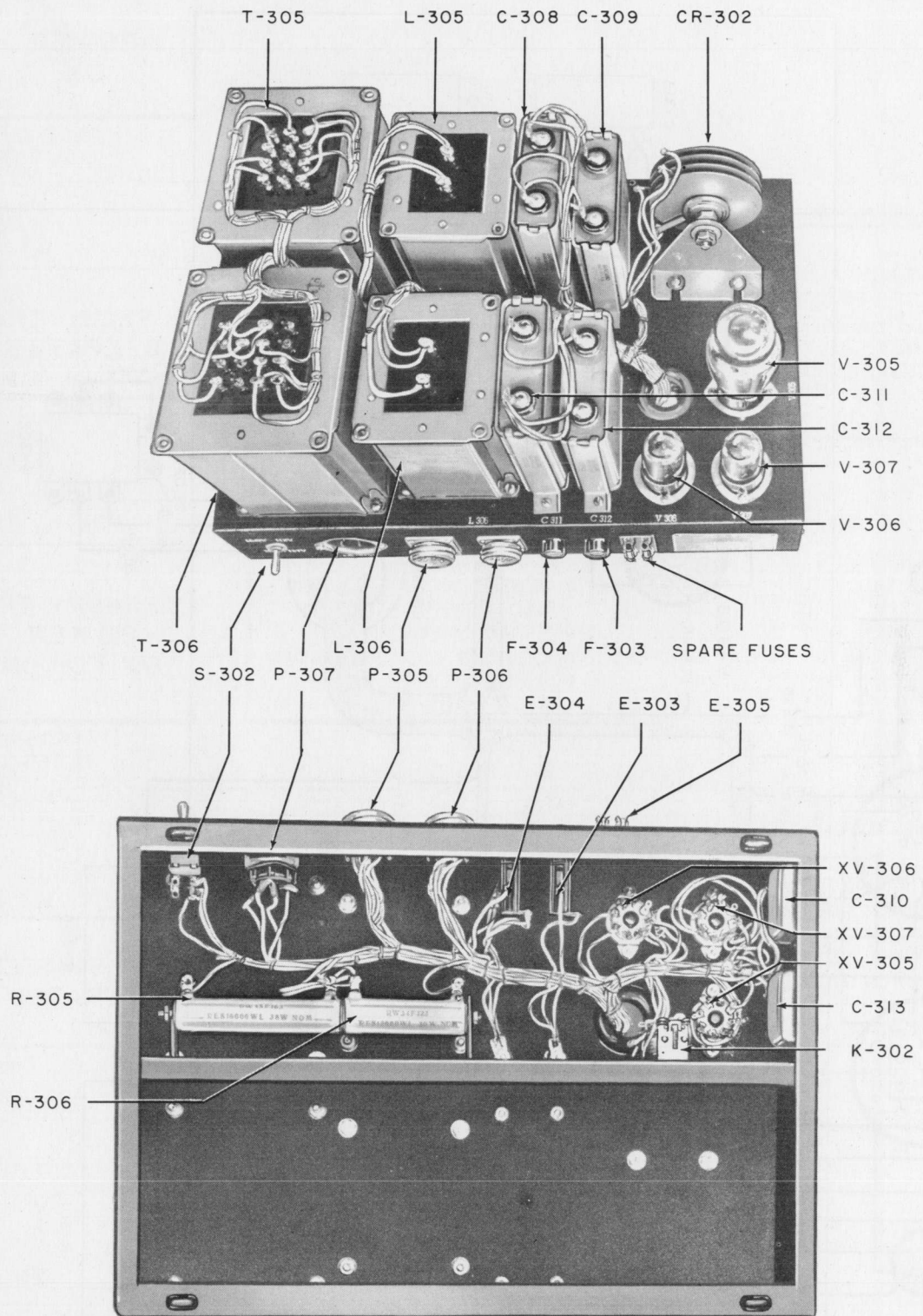

Figure 4-2. Power Supply PP-380/U, Parts Identification

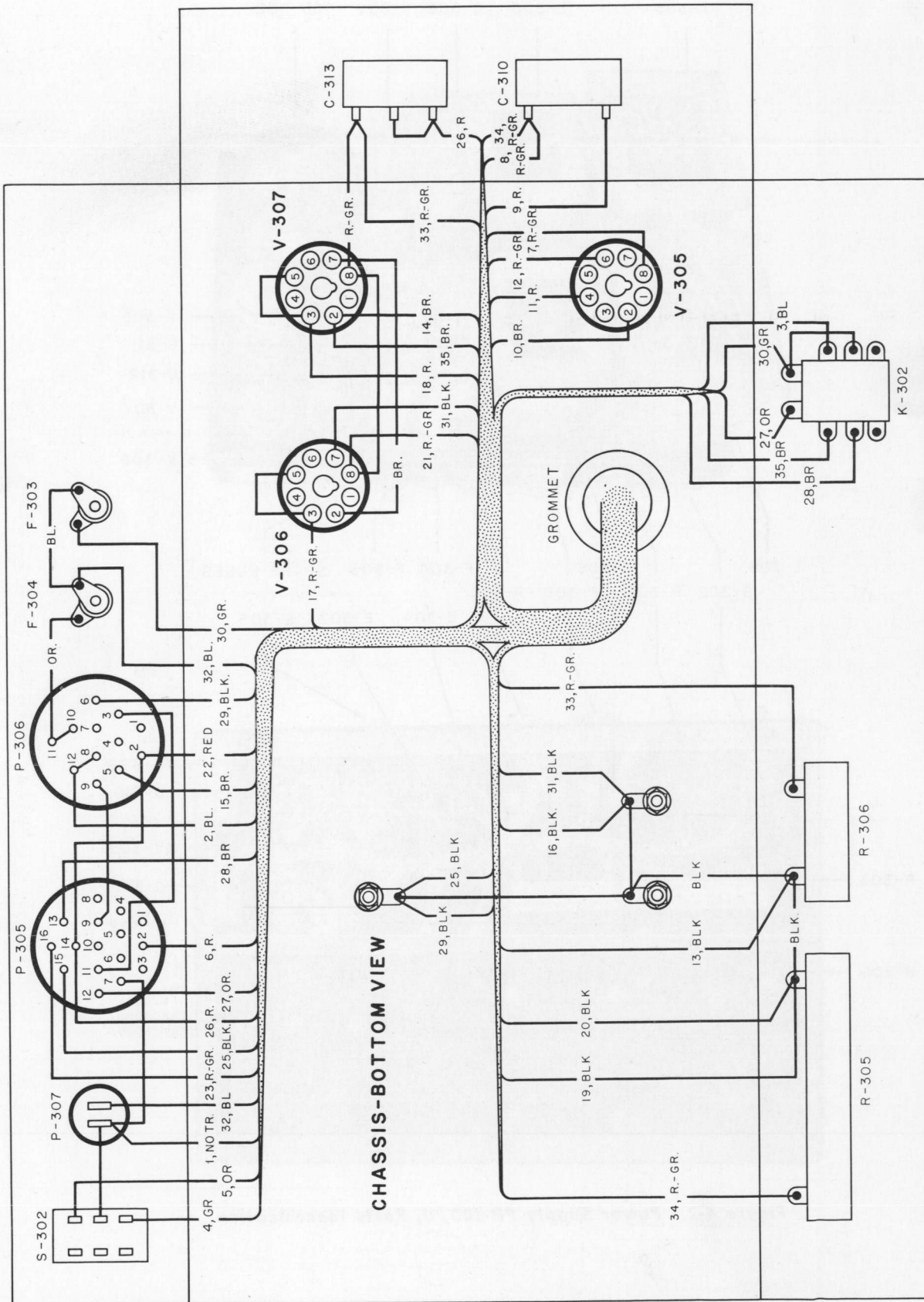
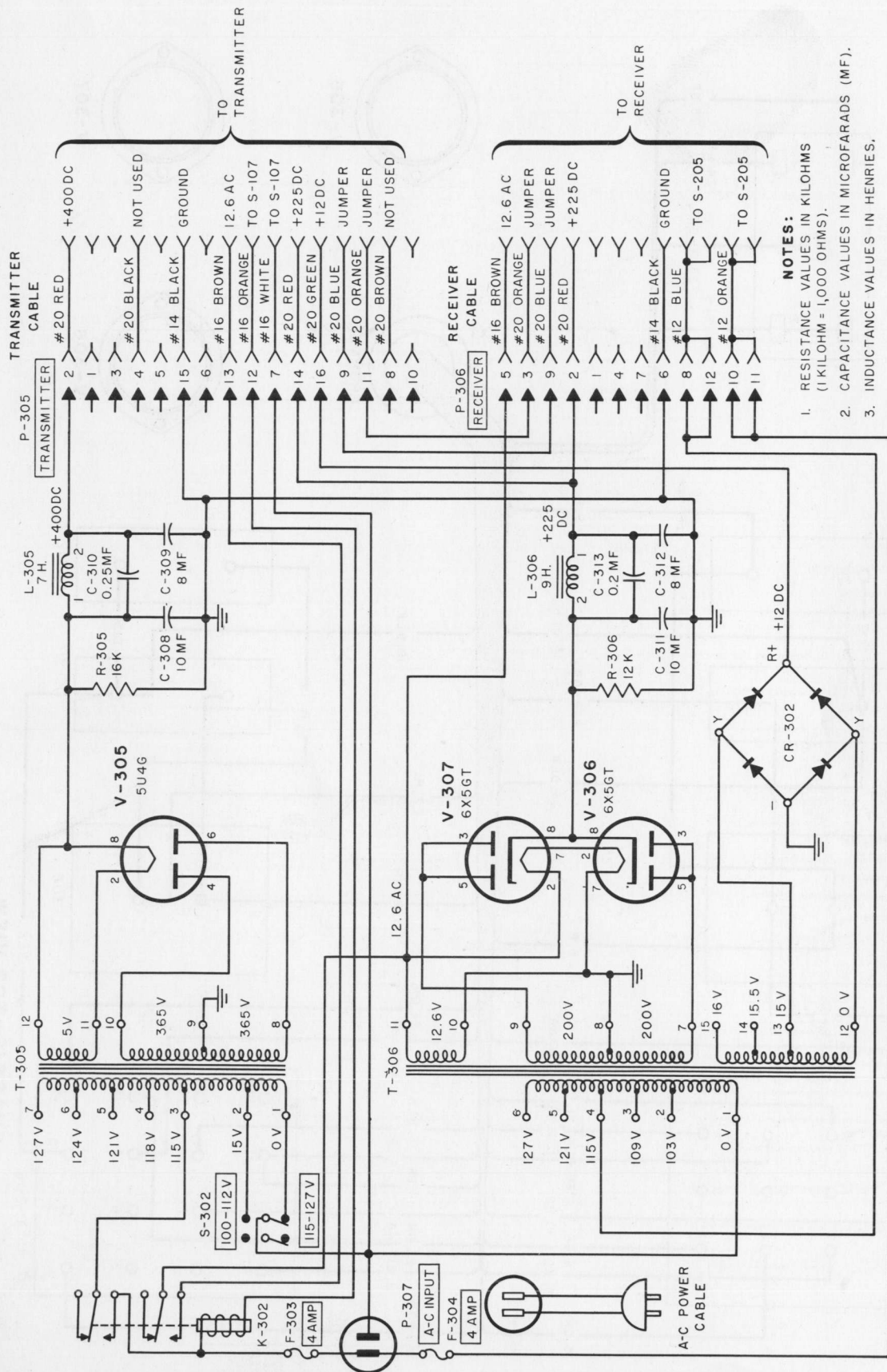

Figure 4-4. Power Supply PP-380/U, Practical Wiring Diagram of Chassis Bottom



- NOTES:**
1. RESISTANCE VALUES IN KILOHMS (1 KILOHM = 1,000 OHMS).
 2. CAPACITANCE VALUES IN MICROFARADS (MF).
 3. INDUCTANCE VALUES IN HENRIES.

Figure 4-3. Power Supply PP-380/U, Schematic Diagram

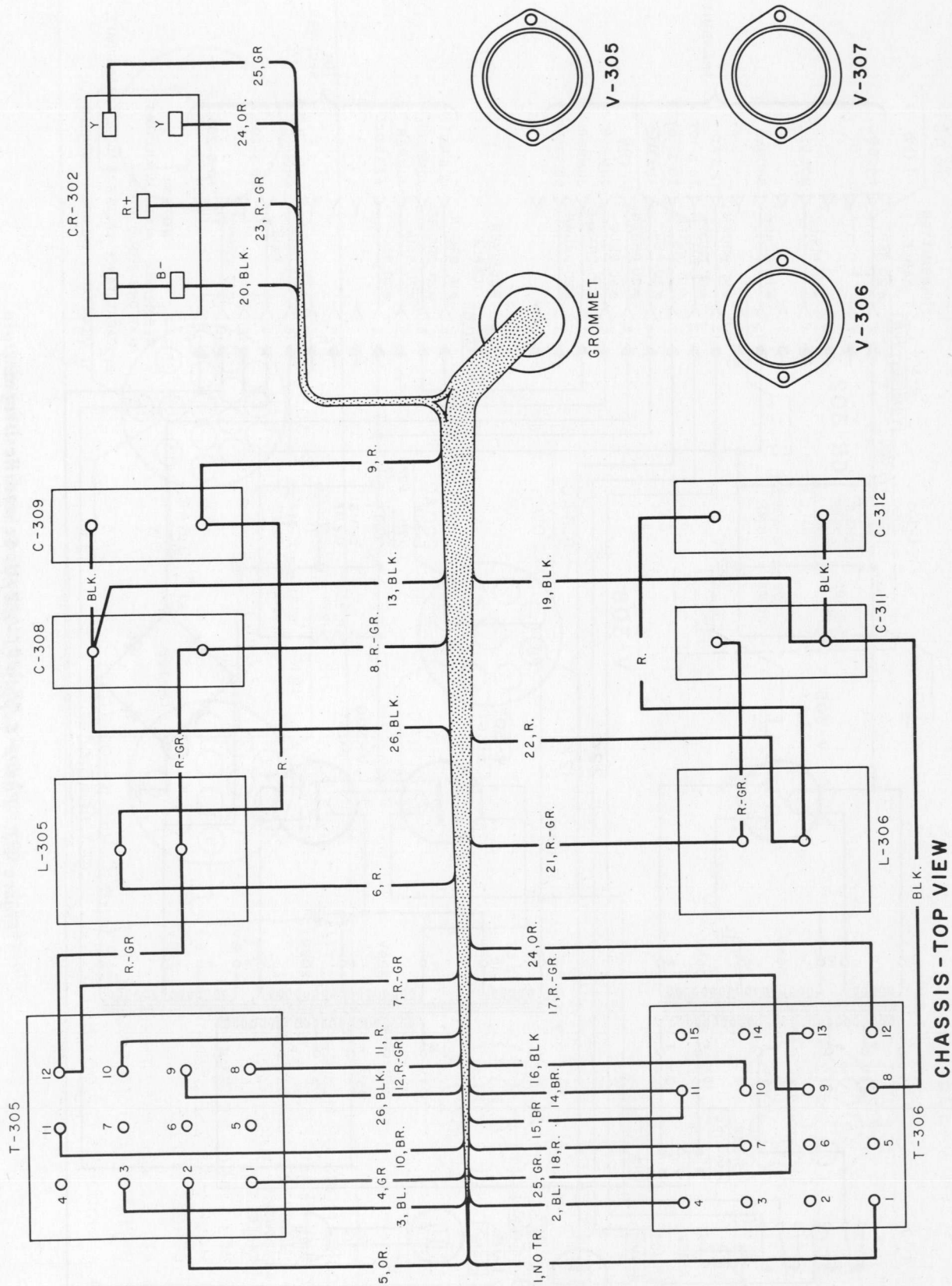
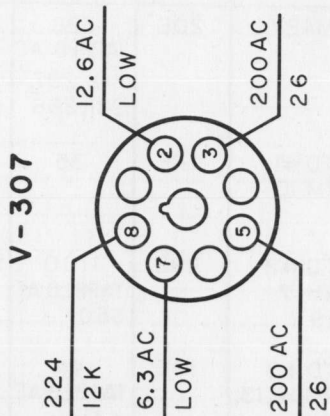
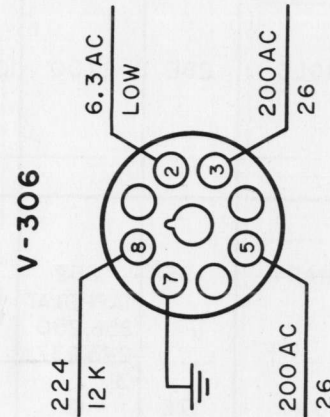
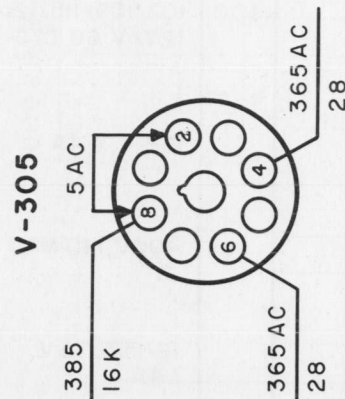
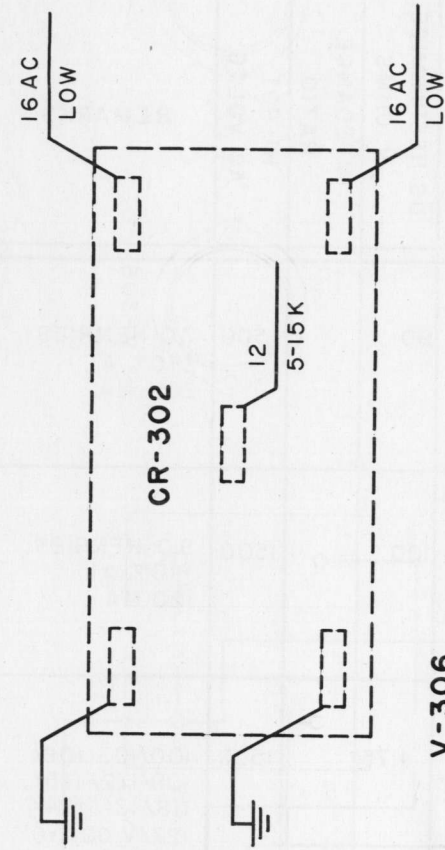

Figure 4-5. Power Supply PP-380/U, Practical Wiring Diagram of Chassis Top



- CONDITIONS OF MEASUREMENT**
1. ALL MEASUREMENTS MADE FROM INDICATED POINT TO CHASSIS, EXCEPT THOSE MARKED
 2. RESISTANCE MEASUREMENTS MADE WITH THE UNIT DISCONNECTED
 3. ALL DC VOLTAGES POSITIVE WITH RESPECT TO CHASSIS
 4. K = KILOHMS (1,000 OHMS)

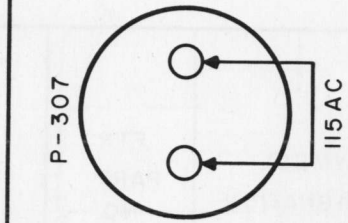
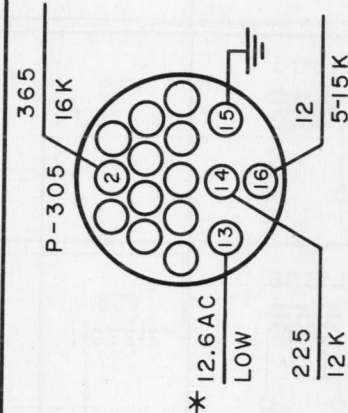
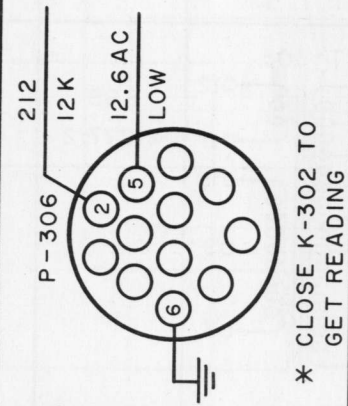
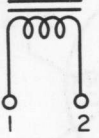
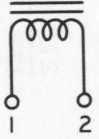
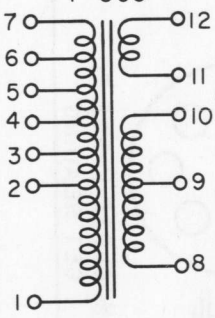
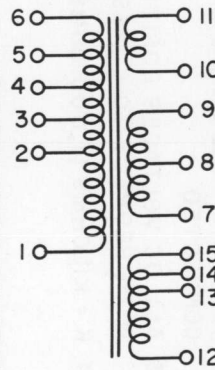

Figure 4-6. Power Supply PP-380/U, Voltage and Resistance Data

TABLE 4-1. WINDING DATA

SYMBOL DESIGNATION	FTR PART NO.	WINDING	WIRE SIZE	TURNS	DC RESISTANCE IN OHMS	IMPEDANCE RATIO	HI-POT AC VOLTS	REMARKS
L-305 	FSS 21279-1	SINGLE	28E	2370	90		1500	7.0 HENRIES ±10% AT 200 MA.
L-306 	FSS 21280-1	SINGLE	28E	2700	100		1500	9.0 HENRIES ±10% AT 120 MA.
T-305 	FSS 21277-2	PRIMARY SEC'D.#1 TERM. 11 & 12 SEC'D.#2 TERM. 8, 9 & 10	19E	262 TAPPED AT 256, 250 243, 237, 31. 12 1600 TAPPED AT 800	1.75 0.05 57		1500	100/103/106/ 109/112/115/ 118/121/124/ 127/V. 60 CYC. 5V., 30A 730V., 230 MA CT
T-306 	FSS 21278-2	PRIMARY SEC'D.#1 TERM. 10 & 11 SEC'D.#2 TERM. 7, 8, & 9 SEC'D.#3 TERM. 12, 13, 14, & 15	20E	328 TAPPED AT 312, 297, 281, 266 35 1100 TAPPED AT 550 44 TAPPED AT 43, 41	2.3 0.06 52 0.3		1500	103/109/115/121/ 127/V. 60 CYC 12.6V., 4.4A 400V., 140 MA CT 16/15.5/15 V., 1.4A

SECTION 5
PARTS LISTS

TABLE 5-1. LIST OF MAJOR UNITS

SYMBOL GROUP	NAME OF MAJOR UNIT	NAVY TYPE	DESIGNATION
300 series	Power Supply	----	PP-380/U

TABLE 5-2. MAINTENANCE PARTS LIST

REFERENCE SYMBOL	STOCK NUMBERS SIGNAL CORPS STANDARD NAVY AIR FORCE	NAME AND DESCRIPTION	LOCATING FUNCTION
		POWER SUPPLY PP-380/U	
300 series	— — —	POWER SUPPLY: Army-Navy Power Supply PP-380/U; electronic type; outputs 400 v DC, 0.20 amp/ 225 v DC, 0.12 amp/ 12 v DC, 1.225 amp/ 12.6 v AC, 3.90 amp; input 100/127 v, 60 cyc, single phase; 17 3/4" lg x 12 3/4" wd x 9 1/2" h overall; uses 5U4G and two 6X5GT; full wave and bridge rectification; AF filter; no mtg provisions; p/o Navy Model TCS series Radio, Telephone and Telegraph Transmitting and Receiving Equipment; Fed Tele & Rad type FTR-3381-A1	Major unit
C-308	N16-C-51881-9110 —	CAPACITOR, fixed: paper dielectric; JAN type #CP70B1FF106V; 10 mf plus 20% minus 10%; 600 vdcw; hermetically sealed metal can; 3 3/4" lg x 1 1/4" wd x 4 3/4" h; mineral oil filled and impregnated; two rivet lug term located on top; no internal ground connections; 2 footed mtg brackets w/ 0.187" diam hole in each on 4 3/8" mtg/c; Sangamo; spec JAN-C-25	V-305 filter input section
C-309	— N16-C-51501-9840 —	CAPACITOR, fixed: paper dielectric; JAN type #CP70B1FF805V; 8 mf plus 20% minus 10%; 600 vdcw; hermetically sealed metal can; 3 3/4" lg x 1 1/4" wd x 4 3/4" h; mineral oil filled and impregnated; two rivet lug term located on top; no internal ground connections; 2 footed mtg brackets w/ 0.187" diam hole in each on 4 3/8" mtg/c; Sangamo; spec JAN-C-25	V-305 filter output section
C-310	— N16-C-46347-3081 —	CAPACITOR, fixed: paper dielectric; JAN type #CP53B1EF254K; 250,000 mmf p/m 10%; 600 vdcw; hermetically sealed metal case; 1-13/16" lg x 1" wd x 3/4" h; mineral oil filled and impregnated; 2 solder lug term; no internal ground connections; two 3/16" mtg holes on 2 1/8" mtg/c; Sangamo; spec JAN-C-25	L-305 resonating
C-311	—	Same as C-308	V-306/7 filter input section
C-312	—	Same as C-309	V-306/7 filter output section
C-313	— N16-C-53192-8190 —	CAPACITOR, fixed: paper dielectric; JAN type #CP53B4EF104L; 2-sect; 100,000 mmf p/m 15% per sect; 600 vdcw; hermetically sealed metal case; 1-13/16" lg x 1" wd x 3/4" h; mineral oil filled and impregnated; 3 solder lug term; no internal ground connections; two 3/16" mtg holes on 2 1/8" mtg c; Sangamo; spec JAN-C-25	L-306 resonating
E-303	— N17-F-74267-5101 —	HOLDER, fuse: extractor post type; for single 3AG cartridge fuse; bakelite body w/ tinned brass term; 8 amp, 250 v max; 2 1/8" lg x 23/32" diam overall; 1/2" diam threaded body for panel hole mtg; 2 solder lug term, one on side of body, one at end; Littelfuse catalog #341001;	Power fuse holder
E-304	—	Same as E-303	Power fuse holder

E-305	N17-F-73773-8227	HOLDER, fuse: block type; for two 3AG cartridge fuses; bakelite base w/ nickel plated copper clips; 1 1/2" lg x 1" wd x 7/16" h overall; no terminals; Jones HB #801-S less solder lug term;	Spare fuse holder
F-303	N17-F-16302-130	FUSE, cartridge: Navy Type -28032-4 4 amp, carry 110% of rating, open in 1 hr at 135% of rating; 250 v; one time; glass body; ferrule terminals; 1 1/4" lg x 1/4" diam; 1/4" diam term; Buss part #MTH4	Power fuse
F-304		Same as F-303	Power fuse
K-302	N17-R-64235-6869	RELAY, armature: contact arrangement 2C; contact rating 3 amp, 110 v AC; silver contacts 1/8" diam; single-wound coil, 115 v 50/60 cyc AC, insulated coil; solder lug term on coil and contacts; 1 3/4" lg x 1-3/16" wd x 1 1/8" h overall; single mtg stud 3/8" lg w/ 6-32 thd and 1/8" diam locating pin on 1/2" mtg/c; stud at center of relay base bottom; fast acting; Advance Electric Co. part #K1504;	Xmtr pwr relay
L-305	N16-R-29157-1865	REACTOR: filter choke; 7 hy, 200 ma; 90 ohms DC resistance; 1500 v RMS test; potted in metal case; 4-3/16" lg x 3 1/2" wd x 4-11/16" h overall; four 7/32" diam mtg holes on 3-9/16" x 2-15/16" mtg/c; 2 solder lug term on top; Freed Trans specification #16993; Fed Tele & Rad part/dwg #FSE-23732-1; spec Navy 16T30;	V-305 filter choke
L-306	N16-R-29220-8616	REACTOR: filter choke; 9 hy, 120 ma; 100 ohms DC resistance; 1500 v RMS test; potted in metal case; 4-3/16" lg x 3 1/2" wd x 4-11/16" h overall; eight 7-32" diam mtg holes on 3-9/16" x 2-15/16" mtg/c; 2 solder lug term on bottom; Freed Trans specification #16994; Fed Tele & Rad part/dwg #FSE-23733-1; spec Navy 16T30;	V-306/7 filter choke
P-305	2Z7126.1 17-C-73599-6086	CONNECTOR, receptacle: Navy Type -49893 16 round male cont, pol; straight type; 1 3/8" x 1 3/8" wd x 3/4" h; cont #1 to #12 incl, #14, and #16 rated 10 amp for #16 wire, cont #13 and #15 rated 30 amp for #10 wire; cylindrical aluminum alloy body, sand blasted and sprayed w/ clear laquer, w/ square mtg fl; molded black bakelite insert; four 0.120" diam mtg holes on 1.038" x 1.038" mtg/c; Cannonlec part #SK-C16-32S; Fed Tele & Rad pt/dwg #FSM-25924-1;	TRANSMITTER connector
P-306	2ZK7122.15 N17-C-73574-9131	CONNECTOR, receptacle: Navy Type #49899 12 round male cont, pol; straight type; 1 1/4" lg x 1 1/4" wd x 3/4" h; cont rated 10 amp; cylindrical aluminum body, sand blasted and sprayed w/ clear laquer; molded black bakelite insert; four 0.120" diam mtg holes on 0.972" x 0.972" mtg/c; Cannonlec part #GK-12-32S; Fed Tele & Rad pt/dwg #FSM-25925-1;	RECEIVER connector
P-307	6Z7589 N17-C-73446-5848	CONNECTOR, receptacle: Navy Type #49643 two rectangular male cont, non pol; straight type; 2-1/16" lg x 1 1/8" wd x 1-3/16" h; cont rated 15/10 amp at 110/250 v; cylindrical bakelite body; two 5/32" mtg holes on 1 3/4" mtg/c; incl nickel pl steel shell for below surface mtg; Amphenol part #61-M10; Fed Tele & Rad pt/dwg #FSM-25922-1;	A-C INPUT connector
R-305	N16-R-66462-5931	RESISTOR, fixed: wire wound; JAN type #RW35F163; 16,000 ohms p/m 5%; 38 w at 275 °C max continuous oper temp; body dimen 4" lg x 29/32" diam; cement coating, resistant to humidity; 2 solder lug term; WL type #RW35F163; spec JAN-R-26A;	V-305 bleeder
R-306	N16-R-66425-6211	RESISTOR, fixed: wire wound; JAN type #RW34F123; 12,000 ohms p/m 5%; 30 w at 275 °C max continuous oper temp; body dimen 3" lg x 29/32" diam; cement coating; resistant to humidity; 2 solder lug term; WL type #RW34F123; spec JAN-R-26A;	V-306 bleeder

TABLE 5-2. MAINTENANCE PARTS LIST—(CONT'D)

REFERENCE SYMBOL	STOCK NUMBERS SIGNAL CORPS STANDARD NAVY AIR FORCE	NAME AND DESCRIPTION	LOCATING FUNCTION
POWER SUPPLY PP-380/U—(CONT'D)			
S-302	— N17-S-73959-1025	SWITCH, toggle: DPDT; JAN type #ST52N; 30 amp at 30 v DC; phenolic body; body dimen 1-21/64" lg x 49/64" wd x 1-1/16" h; bat type handle; solder lug term; single hole mtg bushing 15/32-32NS-2, 15/32" lg; spec JAN-S-23;	Line voltage adj.
T-305	— N17-T-73318-3005	TRANSFORMER, power: filament and plate type; input 100/127 v, 60 cyc, single ph, tapped at 15, 115, 118, 121, 124, and 127 v; 2 output windings; secd #1 730 v at 230 ma CT, secd #2 5 v at 3 amp; 1000 v insulation; air coolant, potted metal case; enclosed metal case; 4 1/4" lg x 5 1/8" wd x 5 1/4" h; 12 solder lug term on top of case; four 7/32" mtg holes on 4 1/2" x 3 5/8" mtg/c; Freed Trans spec #16995; Fed Tele & Rad pt/dwg #FSE-23730-1; spec Navy 16T30;	400 volt supply transformer
T-306	— N17-T-73580-7001	TRANSFORMER, power: filament and plate type; input 103/127 v, 60 cyc, single ph, tapped at 103, 109, 115, 121, and 124 v; 3 output windings; secd #1 400 v at 140 ma CT, secd #2 12 v at 4.4 amp, secd #3 16/15.5/15 v at 1.4 amp; 1000 v insulation; air coolant, potted metal case; enclosed metal case; 4 1/4" lg x 5 1/8" wd x 5 1/4" h; 15 solder lug term on top of case; four 7/32" mtg holes on 4 1/2" x 3 5/8" mtg/c; Freed Trans spec #16996; Fed Tele & Rad pt/dwg #FSE-23731-1; spec Navy 16T30;	225 volt supply
V-305	— N16-T-55464	TUBE, electron: JAN type #5U4G full-wave high-vacuum rectifier; spec JAN-1A;	400 volt rectifier
V-306	— N16-T-56758	TUBE, electron: JAN type #6X5GT; full-wave high-vacuum rectifier; spec JAN-1A;	225 volt rectifier
V-307	—	Same as V-306	225 volt rectifier
W-301	— N17-C-48853-9751	CABLE ASSEMBLY, power: one #14 AWG stranded cond, three #16 AWG stranded cond, seven #20 AWG stranded cond; synthetic ins; 600 vdcw, cotton binder, synthetic jacket; 10 ft lg excluding terminations; Cannonelec #SK-C16-21 1/2 and AN-3057-8 at one end and Cannonelec #SK-C16-23 1/2AC and AN-3057-8 at other end; p/o Army-Navy Rectifier Power Supply PP-380/U; Fed Tele & Rad pt-dwg #FSA-23724-1;	TRANSMITTER cable
W-302	— N17-C-48753-7901	CABLE ASSEMBLY, power: two #12 AWG stranded cond, one #14 AWG stranded cond, one #16 AWG stranded cond, three #20 AWG stranded cond, synthetic ins, 600 v working, cotton binder, synthetic jacket 10 ft lg excluding terminations; Cannonelec #CK-12-23 1/2 AC and AN-3057-8 at one end and Cannonelec #CK-12-21 1/2 AC and AN-3057-8 at other end; p/o Army-Navy Rectifier Power Supply PP-380/U; Fed Tele & Rad pt/dwg #FSA-23725-1;	RECEIVER cable

W-303	— N17-C-48226-1886 —	CABLE ASSEMBLY, power: Underwriters type SJ; two #18 AWG stranded cond; 600 v working; 6 ft lg excluding terminations; molded-on parallel-blade male rubber body plug at one end and Amphenol #61F4 female connector body at other end; p/o Army-Navy Rectifier Power Supply PP-380/U; Fed Tele & Rad pt/dwg #FSN-21462-1;	A-C INPUT cable
CR-302	— N17-R-50994-4455 —	RECTIFIER, metallic: selenium; input 16 v AC, 60 cyc, output 12 v DC, 3 amp at 50°C ambient; round, 3-7/16" lg x 3-3/8" wd x 4-9/16" h overall; two 0.266" x 9/16" mtg slots on 1/8" mtg/c; Fed Tele & Rad part #206B1BLX1, dwg #FSJ-24532-1;	12-volt rectifier
XV-305	— N16-S-63516-6551 —	SOCKET, tube: octal; Navy Type #49374-A below chassis saddle mtg; two 5/32" mtg holes 1-1/2" c to c on molded-in mtg plate 1-7/8" lg x 1-9/32" wd; round mica-filled bakelite body 1-7/64" diam x 31/64" h excluding term; phosphor bronze silver pl cont; Cinch part #CMG-9857; Fed Tele & Rad pt/dwg #FSE-26059-1;	V-305 socket
XV-306		Same as XV-305	V-306 socket
XV-307		Same as XV-307	V-307 socket

TABLE 5-3. CROSS REFERENCE PARTS LIST

JAN DESIGNATION	KEY SYMBOL	NAVY TYPE	KEY SYMBOL	STANDARD NAVY STOCK NO.	KEY SYMBOL	SIGNAL CORPS STOCK NO.	KEY SYMBOL
CP53B1EF254K	C-310	-28032-4	F-303	16-C-46347-3081	C-310	2Z7126.1	P-305
CP53B4EF104L	C-313	-49374-A	XV-305	16-C-51501-9840	C-309	2ZK7122.15	P-306
CP70B1FF106V	C-308	-49643	P-307	16-C-51881-9110	C-308	6Z7589	P-307
CP70B1FF805V	C-309	-49893	P-305	16-C-53192-8190	C-313		
RW34F123	R-306	-49899	P-306	16-R-29157-1865	L-305		
RW35F163	R-305			16-R-29220-8616	L-306		
ST52N	S-302			16-R-66425-6211	R-306		
5U4G	V-305			16-R-66462-5931	R-305		
6X5GT	V-306			16-S-63516-6551	XV-305		
				16-T-55464	V-305		
				16-7-56758	V-306		
				17-C-48226-1886	W-303		
				17-C-48753-7901	W-302		
				17-C-48853-9751	W-301		
				17-C-73446-5848	P-307		
				17-C-73574-9131	P-306		
				17-C-73599-6086	P-305		
				17-F-16302-130	F-303		
				17-F-73773-8227	E-305		
				17-F-74267-5101	E-303		
				17-R-50994-4455	CR-302		
				17-R-64235-6869	K-302		
				17-S-73959-1025	S-302		
				17-T-73318-3005	T-305		
				17-T-73580-7001	T-306		

TABLE 5-4. COLOR CODES AND MISCELLANEOUS DATA.

CAPACITOR COLOR CODES

RMA 3-DOT COLOR CODE FOR MICA-DIELECTRIC CAPACITORS

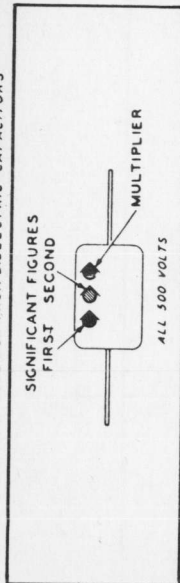

JAN 6-DOT COLOR CODE FOR PAPER-DIELECTRIC CAPACITORS

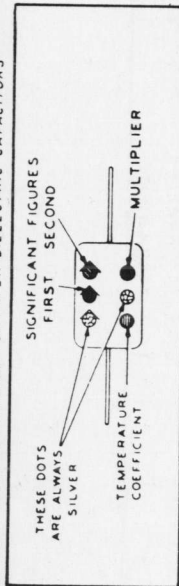

RMA 6-DOT COLOR CODE FOR MICA-DIELECTRIC CAPACITORS

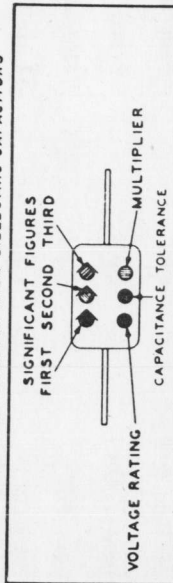

JAN 6-DOT COLOR CODE FOR MICA-DIELECTRIC CAPACITORS

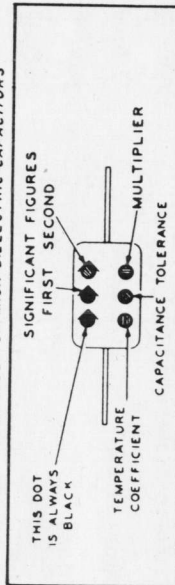

RMA COLOR CODE FOR TUBULAR CERAMIC-DIELECTRIC CAPACITOR S

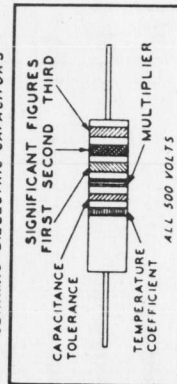

JAN COLOR CODE FOR FIXED CERAMIC-DIELECTRIC CAPACITORS

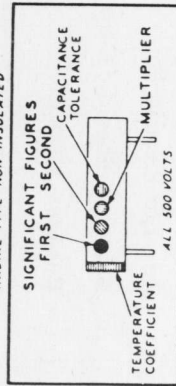

JAN COLOR CODE FOR FIXED CERAMIC-DIELECTRIC CAPACITORS

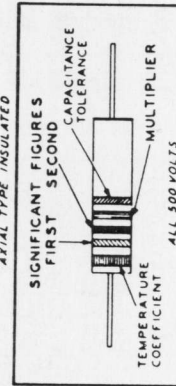

RMA: RADIO MANUFACTURERS ASSOCIATION
JAN: JOINT ARMY-NAVY

RESISTOR COLOR CODES

RMA COLOR CODE FOR FIXED COMPOSITION RESISTORS

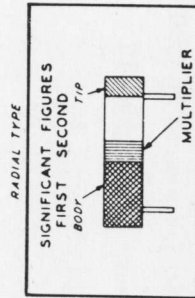
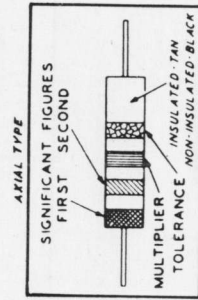

JAN COLOR CODE FOR FIXED COMPOSITION RESISTORS

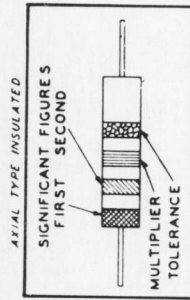

RADIAL TYPE NON-INSULATED

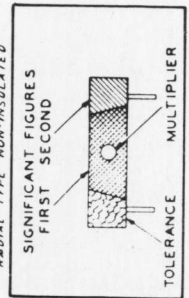

RESISTORS		CAPACITORS				
TOLERANCE	MULTIPLIER	RMA MICA AND CERAMIC-DIELECTRIC	JAN MICA AND PAPER-DIELECTRIC	JAN CERAMIC DIELECTRIC	VOLTAGE RATING	TEMPERATURE COEFFICIENT
	1	1	1	1	100	A
	10	10	10	10	200	B
	100	100	100	100	300	C
	1000	1000	1000	1000	400	D
	10000	10000	10000	10000	500	E
	100000	100000	100000	100000	600	F
	1000000	1000000	1000000	1000000	700	G
	10000000	10000000	10000000	10000000	800	
5	0.1	0.1	0.1	0.01	900	
10	0.01	0.01	0.01	0.01	1000	
20					2000	
					300	

TABLE 5-5. LIST OF MANUFACTURERS

ABBREVIATION	NAVY PREFIX	NAME OF MANUFACTURER	ADDRESS
Advance Electric	CATM	Advance Electric Co.	1260 W. 2nd St., Los Angeles, Cal.
Amphenol	CPH	American Phenolic Corp.	1830 S. 55th Ave., Chicago, Ill.
Buss	CFA	Bussman Mfg. Co.	2538 W. University St., St. Louis, Mo.
Cannonelec	CED	Cannon Elec. Development Co.	3291 Humboldt St., Los Angeles 31, Calif.
Cinch	CMG	Cinch Mfg. Co.	2339 W. Van Buren St., Chicago, Ill.
Fed Tele & Rad	CFT	Federal Telephone & Radio Corp.	900 Passaic Ave., E. Newark, N. J.
Freed Trans	CFX	Freed Transformer Co.	72 Spring St., New York, N. Y.
Jones HB	CJC	Howard B. Jones	2300 W. Wabansia Ave., Chicago, Ill.
Littelfuse	CLF	Littelfuse, Inc.	4765 Ravenswood Ave., Chicago, Ill.
Sangamo	CAN	Sangamo Electric Co.	Springfield, Ill.
WL	CAO	Ward Leonard Co.	6 South St., Mount Vernon, N. Y.