



**32V-2**

**AMATEUR TRANSMITTER**

**Serial No. 1818**

**INSTRUCTION BOOK**

# TABLE OF CONTENTS

Paragraph Page

## SECTION 1 - GENERAL DESCRIPTION

1.1. General . . . . .	1-1
1.2. Reference Data . . . . .	1-2
1.3. Tube Complement . . . . .	1-2

## SECTION 2 - INSTALLATION

2.1. Unpacking . . . . .	2-1
2.2. Placing Transmitters. . . . .	2-1
2.3. External Connections . . . . .	2-1
2.3.1. Power Line . . . . .	2-1
2.3.2. Microphone & Key . . . . .	2-1
2.3.3. Receiver Disabling Circuit . . . . .	2-1
2.3.4. Remote Relay Connections. . . . .	2-2
2.3.5. CW Sidetone . . . . .	2-2
2.3.6. Receiver Muting . . . . .	2-2
2.3.7. Radiation System . . . . .	2-2
2.3.8. External Antenna Tuner (Not Supplied) . . . . .	2-2

## SECTION 3 - ADJUSTMENT AND OPERATION

3.1. Adjustment . . . . .	3-1
3.1.1. 600 v - 700 v - Switch . . . . .	3-1
3.1.2. Calibration . . . . .	3-1
3.2. Operation. . . . .	3-1
3.2.1. General . . . . .	3-1
3.2.2. Function of Controls . . . . .	3-2
3.2.3. Operation Procedure . . . . .	3-3

TABLE OF CONTENTS

<u>Paragraph</u>	<u>Page</u>
<u>SECTION 3 - ADJUSTMENT AND OPERATION (cont.)</u>	
3.2.4. Typical Meter Readings . . . . .	3-5
3.2.5. Dial Calibration . . . . .	3-5
3.2.6. Antenna Loading Table . . . . .	3-5
<u>SECTION 4 - CIRCUIT DESCRIPTION</u>	
4.1. General . . . . .	4-1
4.2. Circuit Description . . . . .	4-1
4.2.1. RF Circuits . . . . .	4-1
4.2.2. Audio Circuits . . . . .	4-2
4.2.3. High Voltage Supply . . . . .	4-2
4.2.5. Receiver Muting Circuit. . . . .	4-3
<u>SECTION 5 - MAINTENANCE</u>	
5.1. Inspection . . . . .	5-1
5.1.1. General . . . . .	5-1
5.1.2. Routine Inspection . . . . .	5-1
5.2. Trouble Shooting . . . . .	5-3
5.2.1. General. . . . .	5-3
5.2.2. Fuses. . . . .	5-3
5.3. Alignment . . . . .	5-4
5.3.1. General. . . . .	5-4
5.3.2. High Frequency Oscillator . . . . .	5-4
5.3.3. Multiplier Stages . . . . .	5-6
5.3.4. Modulator Bias Adjustment . . . . .	5-7
5.4. Lubrication . . . . .	5-7

TABLE OF CONTENTS

Paragraph

Page

SECTION 5 - MAINTENANCE (Cont.)

5.5. Oscillator Tube Removal . . . . . 5-7  
5.6. Desiccant Capsule . . . . . 5-7

SECTION 6 - PARTS LIST



## LIST OF ILLUSTRATIONS

<u>Figure</u>	<u>Title</u>
1-1	Model 32V Amateur Transmitter
2-1	Tube Placement Diagram
2-2	Typical Antenna Tuner
2-3	Typical Antenna Tuner Circuits
3-1	Control Functions
3-2	Typical Dial Readings
5-1	Alignment Adjustments
5-2	Parts Arrangement - Top View
5-3	Parts Arrangement - Bottom View
5-4	Parts Arrangement - Left Side Open
5-5	Parts Arrangement - Right Side Open
5-6	Parts Arrangement - Rear Open
5-7	Parts Arrangement - 70E-8 Open
5-8	Model 32V-2 Complete Schematic Diagram

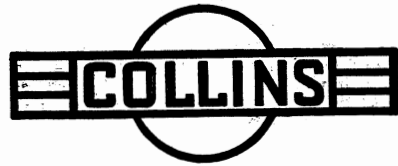

32V 2

**AMATEUR TRANSMITTER**

**INSTRUCTION BOOK**

3 2 V - 2

A M A T E U R   T R A N S M I T T E R

Manufactured by

COLLINS RADIO CO., CEDAR RAPIDS, IOWA

520 9429 00

**AUG 29 1949**

# TABLE OF CONTENTS

<u>Paragraph</u>	<u>Page</u>
<u>SECTION 1 - GENERAL DESCRIPTION</u>	
1.1. General . . . . .	1-1
1.2. Reference Data . . . . .	1-2
1.3. Tube Complement . . . . .	1-2
<u>SECTION 2 - INSTALLATION</u>	
2.1. Unpacking . . . . .	2-1
2.2. Placing Transmitters. . . . .	2-1
2.3. External Connections . . . . .	2-1
2.3.1. Power Line . . . . .	2-1
2.3.2. Microphone & Key . . . . .	2-1
2.3.3. Receiver Disabling Circuit . . . . .	2-1
2.3.4. Remote Relay Connections. . . . .	2-2
2.3.5. CW Sidetone . . . . .	2-2
2.3.6. Receiver Muting . . . . .	2-2
2.3.7. Radiation System . . . . .	2-2
2.3.8. External Antenna Tuner (Not Supplied) . . . . .	2-2
<u>SECTION 3 - ADJUSTMENT AND OPERATION</u>	
3.1. Adjustment . . . . .	3-1
3.1.1. 600 v - 700 v - Switch . . . . .	3-1
3.1.2. Calibration . . . . .	3-1
3.2. Operation. . . . .	3-1
3.2.1. General . . . . .	3-1
3.2.2. Function of Controls . . . . .	3-2
3.2.3. Operation Procedure . . . . .	3-3

TABLE OF CONTENTS

<u>Paragraph</u>	<u>Page</u>
<u>SECTION 3 - ADJUSTMENT AND OPERATION (cont.)</u>	
3.2.4. Typical Meter Readings . . . . .	3-5
3.2.5. Dial Calibration . . . . .	3-5
3.2.6. Antenna Loading Table . . . . .	3-5
<u>SECTION 4 - CIRCUIT DESCRIPTION</u>	
4.1. General . . . . .	4-1
4.2. Circuit Description . . . . .	4-1
4.2.1. RF Circuits . . . . .	4-1
4.2.2. Audio Circuits . . . . .	4-2
4.2.3. High Voltage Supply . . . . .	4-2
4.2.5. Receiver Muting Circuit. . . . .	4-3
<u>SECTION 5 - MAINTENANCE</u>	
5.1. Inspection . . . . .	5-1
5.1.1. General . . . . .	5-1
5.1.2. Routine Inspection . . . . .	5-1
5.2. Trouble Shooting . . . . .	5-3
5.2.1. General. . . . .	5-3
5.2.2. Fuses. . . . .	5-3
5.3. Alignment . . . . .	5-4
5.3.1. General. . . . .	5-4
5.3.2. High Frequency Oscillator . . . . .	5-4
5.3.3. Multiplier Stages . . . . .	5-6
5.3.4. Modulator Bias Adjustment . . . . .	5-7
5.4. Lubrication . . . . .	5-7

TABLE OF CONTENTS

Paragraph

Page

SECTION 5 - MAINTENANCE (Cont.)

5.5. Oscillator Tube Removal . . . . . 5-7  
5.6. Desiccant Capsule . . . . . 5-7

SECTION 6 - PARTS LIST

## LIST OF ILLUSTRATIONS

<u>Figure</u>	<u>Title</u>
1-1	Model 32V Amateur Transmitter
2-1	Tube Placement Diagram
2-2	Typical Antenna Tuner
2-3	Typical Antenna Tuner Circuits
3-1	Control Functions
3-2	Typical Dial Readings
5-1	Alignment Adjustments
5-2	Parts Arrangement - Top View
5-3	Parts Arrangement - Bottom View
5-4	Parts Arrangement - Left Side Open
5-5	Parts Arrangement - Right Side Open
5-6	Parts Arrangement - Rear Open
5-7	Parts Arrangement - 70E-8 Open
5-8	Model 32V-2 Complete Schematic Diagram

# COLLINS

## GUARANTEE

The Collins Amateur equipment described herein is sold under the following guarantee:

Collins agrees to repair or replace, without charge, any equipment, parts, or accessories which are defective as to design, workmanship or material, and which are returned to Collins at its factory in Cedar Rapids, Iowa, transportation prepaid provided buyer has completed and returned to Collins promptly following his purchase the Registration Card included in the Instruction Book furnished with the equipment and provided Buyer has given to Collins written notice of the claimed defect in equipment or accessories within ninety (90) days from date of purchase.

The foregoing guarantee shall not be applicable to:

- (a) equipment and accessories manufactured by others than Collins, tubes and batteries, all of which are subject only to such adjustment as Collins may obtain from supplier thereof;
- (b) equipment or accessories which shall fail to operate in a normal or proper manner due to exposure to excessive moisture in the atmosphere or otherwise after delivery, any such failure not being deemed a defect within the meaning of the foregoing provisions;
- (c) any failure due to use of equipment in excess of that contemplated in normal amateur operations, any such failure not being deemed a defect within the meaning of these provisions.

The guarantee of these paragraphs is void if equipment is altered or repaired by others than Collins or its authorized service centers.

Notice of any claimed defect must be given to Collins prior to return of any item. Such notice must give full information as to nature of defect and identification (including part number if possible) of part considered defective. Upon receipt of such notice, Collins will promptly advise respecting return of equipment. Failure to secure our advice prior to the forwarding of goods for return may cause unnecessary delay in the handling of such merchandise.

No other warranties, expressed or implied, shall be applicable to said equipment, and the foregoing shall constitute the Buyer's sole right and remedy under the agreements in this paragraph contained. In no event shall Collins have any liability for consequential damages, or for loss, damage or expense directly or indirectly arising from the use of the products, or any liability to use them either separately or in combination with other equipment or materials, or from any cause.

**IMPORTANT!** It is necessary that the attached business reply card be filled out and mailed to the Company promptly in order for this guarantee to be effective.

COLLINS RADIO COMPANY

**PURCHASER  
MUST fill out  
this card and  
mail to Collins  
in order to  
assure full  
coverage under  
the guarantee**

Postage  
Will be Paid  
by  
Addressee

No  
Postage Stamp  
Necessary  
If Mailed in the  
United States

**BUSINESS REPLY CARD**

First Class Permit No. 236 (Sec. 510 P. L. & R.) Cedar Rapids, Iowa

COLLINS RADIO COMPANY

CEDAR RAPIDS,

IOWA

SALES DEPT.



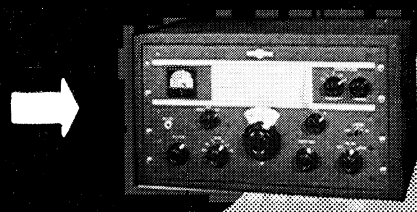

The 32V 150 Watt Bandswitching Transmitter. Permeability Tuned Oscillator Control.

The 30K 500 Watt Bandswitching Transmitter

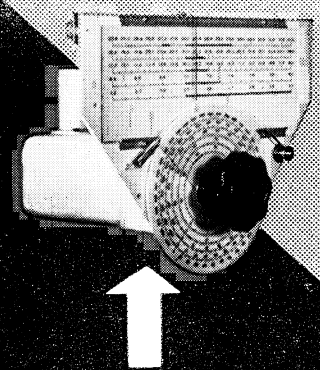
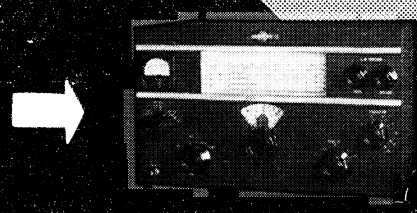
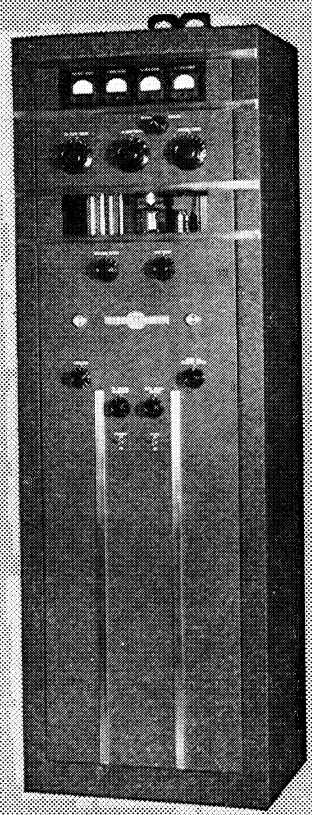

### REGISTRATION CARD

Gentlemen: \_\_\_\_\_ Date \_\_\_\_\_

I have purchased the following unit of Collins Amateur Radio Equipment:

Model No. \_\_\_\_\_

Date Purchased \_\_\_\_\_ Serial No. \_\_\_\_\_

Purchased From: \_\_\_\_\_

Dealer's Name: \_\_\_\_\_

Dealer's Address: \_\_\_\_\_

I am familiar with the Collins Guarantee of Amateur equipment as printed in the instruction book and request that you register ownership of the above described equipment in my name.

Owner's Name \_\_\_\_\_ Call \_\_\_\_\_

Address \_\_\_\_\_

Please send data on the following equipment: \_\_\_\_\_

**BE SURE TO FILL IN THIS CARD COMPLETELY. THANK YOU.**





FIGURE I-1 MODEL 32V AMATEUR TRANSMITTER

## GENERAL DESCRIPTION

Section 1

### SECTION 1

#### GENERAL DESCRIPTION

##### 1.1. GENERAL.

1.1.1. This instruction book has been prepared to assist in the proper installation, adjustment, operation and maintenance of the Collins 32V-2 amateur transmitter.

The type 32V-2 is a transmitter designed for those amateurs who want medium power, bandswitching, and VFO control in a small cabinet. It may be used for either permanent or portable installations. All that is needed for putting it into operation is a 115 volt ac source, an antenna, and a key or microphone. The 32V-2 can also be used to drive a kilowatt final amplifier.

The 32V-2 transmitter is designed for table mounting. The complete transmitter is housed in a single cabinet 21-1/8" wide, 12-7/16" high and 13-7/8" deep and weighs approximately 105 lbs. Ventilating openings are provided in the back, two sides and bottom of the cabinet to assure adequate ventilation for all heat producing elements.

The components of the transmitter are so arranged that unit construction is possible and are broken down in five units as follows:

- 7OE-8A Oscillator
- R-F Unit
- Output Network
- Speech Amplifier and Modulator
- Power Supply

All wiring is independent of the cabinet, and the complete unit may be removed from the cabinet for inspection or maintenance.

Complete coverage of the 80, 40, 20, 15, 11 and 10 meter bands is obtained with the 32V-2. Quick band-change is accomplished by bandswitching on all stages. The permeability tuned circuits of the 1st, 2nd and 3rd multipliers have their tuning controls ganged with the oscillator. The final tank consists of impedance matching network with two separate controls located on the front panel, one for tuning and one for loading.

Two heavy duty toggle switches control the low voltage and high voltage circuits. The switches are arranged so that the high voltage cannot be applied until the low voltage circuits have been energized. A push-to-talk switch, associated with the microphone, may be used to apply the high voltage instead of the HV toggle switch for added convenience.

A CW sidetone oscillator is incorporated in this unit with which CW transmissions can be monitored.

An additional feature, the receiver muting connection, can be used to silence a type 75A receiver during CW transmission for CW break-in operation.

A meter selector switch on the front panel enables the operator to meter all important circuits of the transmitter. This switch can be rotated to five different positions. Each position inserts a meter into the selected circuit to be metered. A separate meter reads FINAL AMPLIFIER plate current only. The CW-CAL-PH switch is used to select the type of emission desired and to calibrate the accuracy of the dial reading against a known standard frequency. In the CW position, the modulator is disabled, the master oscillator operates continuously with the HV switch on and the CW sidetone oscillator is connected to the audio amplifier stages. On "CAL" position a signal of strength suitable for zero-beating with incoming signals may be heard in the associated receiver without operating the final amplifier. On phone position, the key is closed and the modulator is operative. Keying is accomplished by means of grid block keying of the buffer stages. This keying is done on the buffer and first and second multiplier stages.

The AUDIO GAIN Control is used to control the level of modulation and the strength of CW sidetone output.

### 1.2. REFERENCE DATA.

Power Source: 115 volts ac 50/60 cps single phase.

Power Input Requirements: The maximum overall input power requirement is 500 watts at 90% power factor.

PA Plate Power Input: The nominal rated power input of the 32V-2 is 120 watts on phone and 150 watts CW.

Audio Distortion: Audio distortion is less than 8% at 90% modulation with a 1000 cps input frequency.

Frequency Response: Within 2 db from 200-3000 cps.

### 1.3. TUBE COMPLEMENT.

<u>Quantity</u>	<u>Tube Type</u>	<u>Function</u>
1	6SJ7	Oscillator
1	6AK6	Buffer Amplifier
1	6AG7	First Multiplier
1	7C5	Second Multiplier
1	7C5	Third Multiplier
1	4D32	RF Power Amplifier
1	6SL7	Audio Amplifier
1	6SN7	Audio Driver
2	807	Modulators
1	5Z4	LV Rectifier
2	5R4GY	HV Rectifier
1	VR-75	Bias Regulator
1	6SL7GT	CW Sidetone Oscillator
2	0A2	Screen voltage limiters

## SECTION 2

INSTALLATION2.1. UNPACKING.

After the unit has been removed from the packing box, inspect the unit for loose screws or bolts. Be certain all controls, such as switches, dials, etc. work properly. In case of damage, file all claims promptly with the transportation company. If a claim for damage is to be filed, the original packing case and material must be preserved. Check all tubes to see that they are fully in their sockets. See figure 2-1 for tube placement.

2.2. PLACING TRANSMITTER.

The console type cabinet is designed to be placed on the operating table along with the receiving equipment. Allow enough space at the rear for making the necessary external connections and for replacement of fuses. Sufficient clearance at the sides should be provided for full circulation of air.

2.3. EXTERNAL CONNECTIONS.

Place the two power switches in the off position before attempting to make any external connections. The external connections are as follows:

- |                        |                                |
|------------------------|--------------------------------|
| (1) AC Power Line      | (5) Receiver Disabling Circuit |
| (2) Microphone and Key | (6) CW Sidetone                |
| (3) Radiation System   | (7) Receiver Muting            |
| (4) Remote Relay       |                                |

2.3.1. POWER LINE. - The 32V-2 operates from a 115 volt, single phase, 50/60 cycle power source. The supply line should be checked for these specifications. The maximum power required from the line is 500 watts. Insert the 115 volt plug into a convenient standard outlet.

2.3.2. MICROPHONE AND KEY. - The microphone plug is inserted in the microphone jack J201 on the front of the transmitter. Make sure the clamping ring on the microphone plug is tightly turned on the thread around the input receptacle. Push-to-talk control connections are made to pin number 2 to ground in the microphone plug where the microphone being used is equipped with a push-to-talk switch. When using a microphone that does not have such a switch, the transmitter can still be controlled from a remote position by running a pair of leads from terminal 11 and 12 on the rear terminal strip (E308) to a switch box located at some point convenient to the operator.

CAUTION

Do not get the microphone and push-to-talk connections reversed when assembling the microphone plug since the relay voltage present could damage certain types of microphones.

The telegraph key is plugged into the key jack, J101, on the front panel.

2.3.3. RECEIVER DISABLING CIRCUIT. - Terminals 13 and 14 on the rear terminal strip (E308) are connected to normally closed contacts on the carrier control



relay and are to be used for connections to the receiver disabling circuit. Remove the jumper on the receiver terminals and connect terminals 13 and 14 to these two terminals. The receiver can then be made inoperative when the push-to-talk switch is pressed or whenever the HV switch is operated.

2.3.4. REMOTE RELAY CONNECTIONS. - Terminals 7,8,9 and 10 on the rear terminal strip may be used for operating an antenna change-over relay or a relay for turning on the plate power of a power amplifier stage when the 32V-2 is used as an exciter. If a 115 volt ac type relay is used, connect the leads from the relay coil to terminals 7 and 10. In this manner, the relay coil will be energized thru contacts 8 and 9 of relay K301 whenever the push-to-talk switch or HV switch is operated. If a dc type of relay is used, remove the jumper from terminals 8 and 9 and use terminals 9 and 10 to control the operations of the remote relay thru the contacts of the transmitter relay.

CAUTION. - Do not use the RECEIVER DISABLING CIRCUIT AND REMOTE RELAY CONNECTIONS for conducting large currents, as damage to the relay contacts may result.

CAUTION. - For safety reasons, remove the 115 volt plug from the AC power outlet while making connections to the rear terminal strip.

Switch pi S101H, located at the rear of the band switch, can be used to automatically operate antenna selector relays, etc., as the band switch is turned. Connections to this switch section will have to enter the cabinet through a ventilation slot at the side of the cabinet.

2.3.5. CW SIDETONE. - Any 500 ohm or higher impedance headphone or 500 to 1000 ohm speaker can be connected between terminals 16 and 12 (gnd) at the rear of the unit for sidetone output. The sidetone will be operative when the EMISSION switch is in the CW position. Sidetone pitch is controlled from within the top door while the volume is controlled by the AUDIO GAIN control.

2.3.6. RECEIVER MUTING. - If a Collins Model 75A receiver is used for receiving, CW break-in operation can be improved by connecting terminal B on the receiver to terminal 15 on the 32V and terminal G to terminal 12 (gnd). This connection mutes the receiver audio when the key is pressed. For CALIBRATION, the receiver limiter switch should be in the OUT position.

2.3.7. RADIATION SYSTEM. - The output network will match impedance of 26 to 600 ohms on all bands. It will tune out inductive or capacitive reactances normally encountered. The output network is unbalanced with respect to ground and may be used to feed directly into unbalanced systems. Connection to the antenna transmission line is made by means of a PL-259 52 ohm coaxial connector. Do not end feed antennas which are multiples of 1/2 wave in length directly from the antenna terminals; rather, use an external antenna tuner. Random length antennas must not fall on exact odd multiples of 1/4 wave-length long but should be 10 to 20% longer or shorter.

2.3.8. EXTERNAL ANTENNA TUNER. (Not Supplied)

To feed balanced transmission lines, tuned or untuned, couple the transmitter to the transmission line with a simple tuned circuit illustrated below. This arrangement will match a wide range of impedances. It will also add further attenuation to harmonics causing TVI. Figure 2-2 illustrates an antenna tuner which will function satisfactorily in this application. The

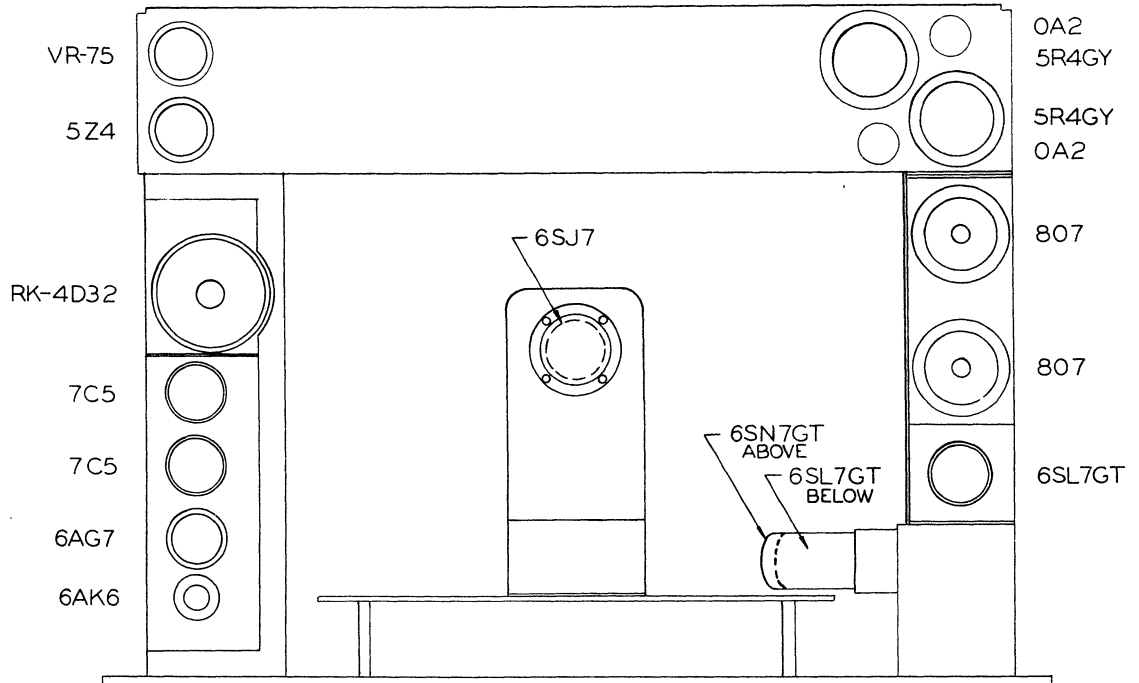

**Figure 2-1 Tube Placement Diagram**

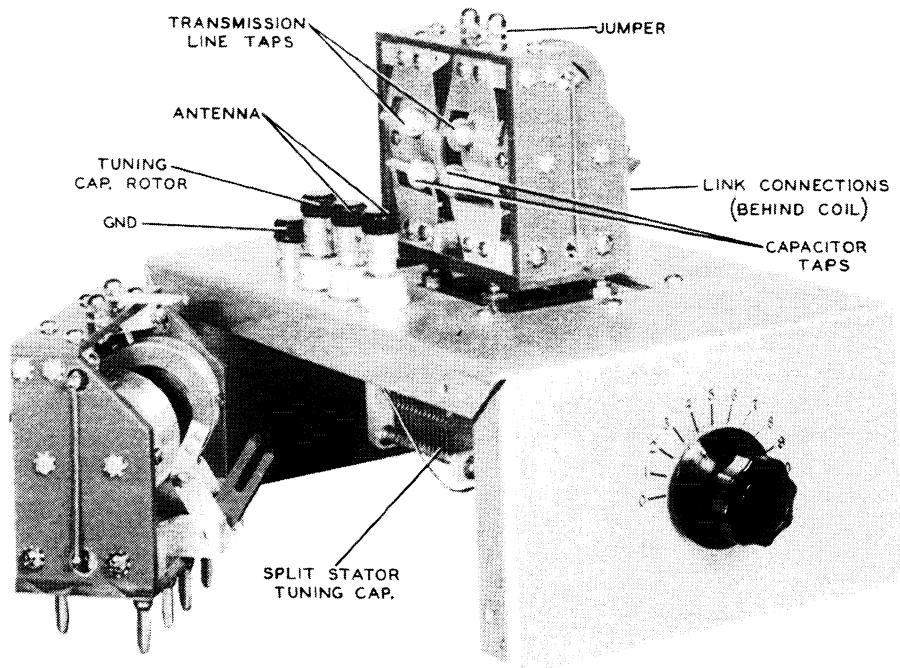

**FIGURE 2-2 TYPICAL ANTENNA TUNER  
(NOT SUPPLIED)**

**NOTE**

This company does not manufacture the above tuner. The photo and data on tuners are offered merely as a guide for constructing a tuner.





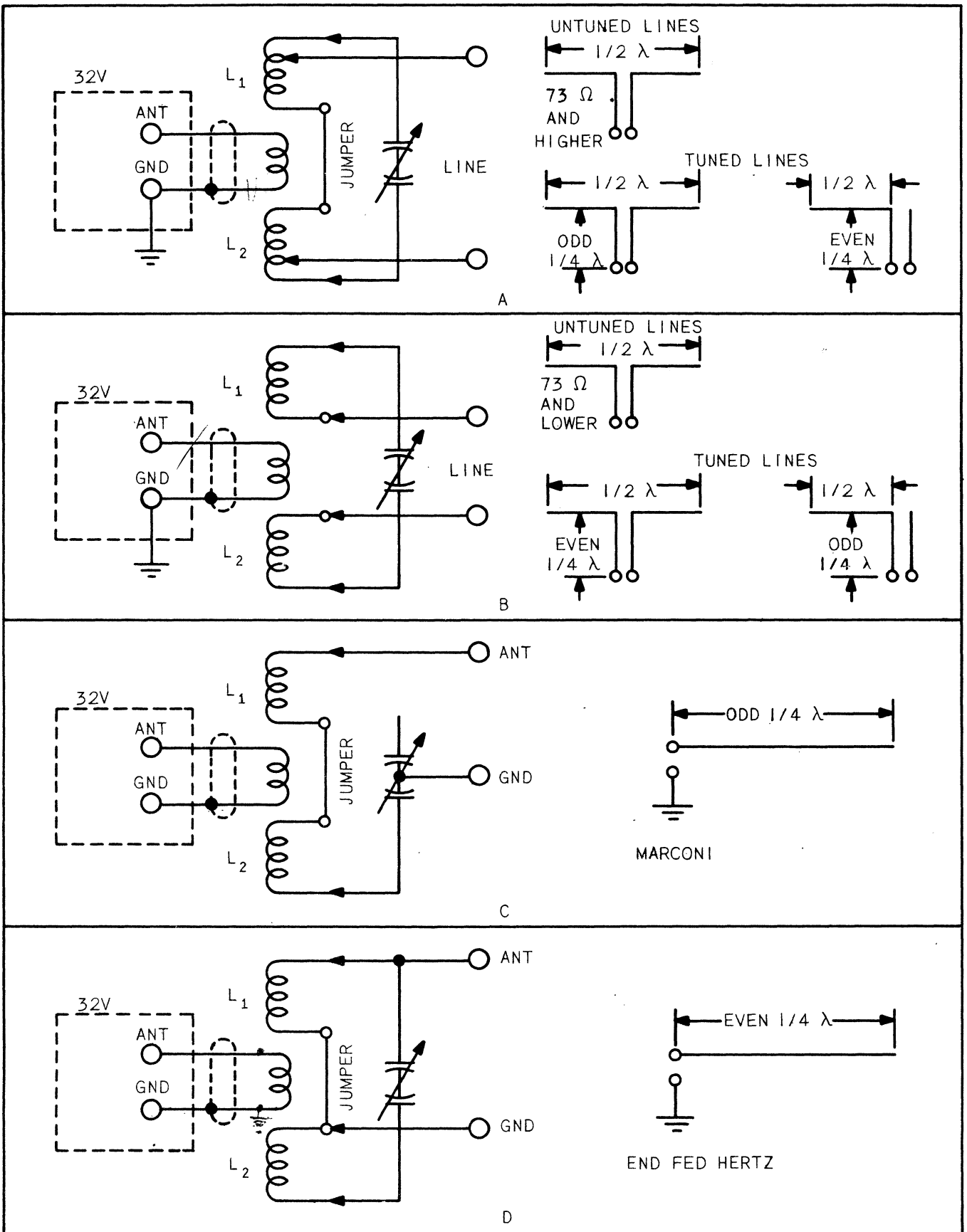
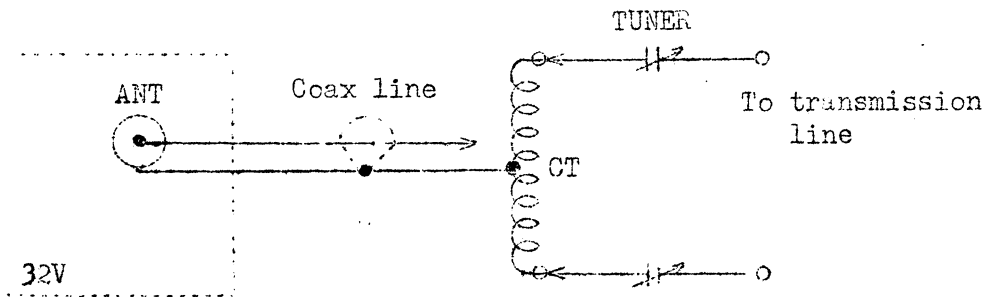
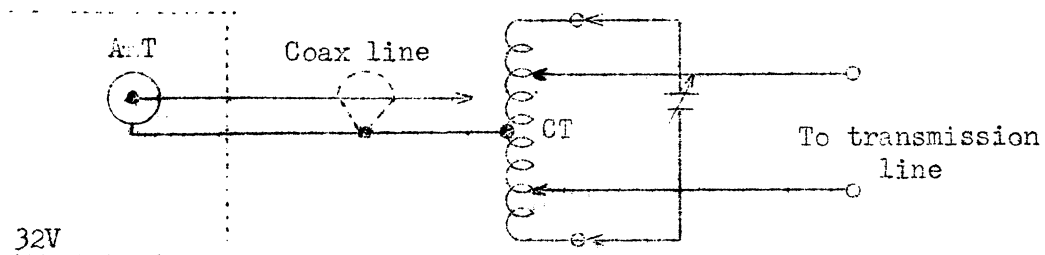

Figure 2-3 Typical Antenna Tuner Circuits



SERIES TUNING



PARALLEL TUNING

AN ALTERNATE ANTENNA TUNER CIRCUIT

impedance of the transmission line is matched by choosing proper taps on the inductances L1 and L2. The coupling link is coupled as tightly as possible and all loading adjustments are done with the LOADING control on the 32V-2.

a. **UNTUNED HIGH IMPEDANCE TRANSMISSION LINE.** - If the line has a characteristic impedance of 73 ohms or more, parallel tuning of the antenna coils L1 and L2 should be employed. For parallel tuning, the little jumper seen above the antenna coils should be closed. The transmission line taps should be set on the same turns as the capacitor taps to start with, then varied towards the center of the coils until proper loading is obtained. The transmission line taps are those at the top of the coils while the capacitor taps are those nearer the bottom. In this type of operation, low values of capacitance and high values of inductance for the operating frequency generally are best. See illustration A., figure 2-3.

b. **UNTUNED LOW IMPEDANCE TRANSMISSION LINES.** - Transmission lines having a characteristic impedance of less than 50 ohms require series tuning of the antenna coils. This is done by opening the small jumper above the coils and moving the transmission line tap arms to the inside coil turns. The capacitor taps should be set at the outside turns and varied towards the inside turns until proper loading is obtained. Higher values of tuning capacity usually work out best in this type of operation. See illustration B., figure 2-3.

c. **VOLTAGE FED TUNED LINES.** - Transmission lines which have a high voltage point at the transmitter should be connected and tuned identically with instructions given in a. above. It is recommended that tuned lines be cut to multiples of a quarter wave in length.

d. **CURRENT FED TUNED LINES.** - Transmission lines having high current at the transmitter end should be connected and tuned identically with instructions given in b. above. These lines should also be cut to exact multiples of a quarter wave in length.

e. **QUARTER WAVE MARCONI.** - Series tuning is indicated for quarter wave Marconi antennas. In this type of operation, the antenna tuning circuit should be connected so that the two sections of the antenna coil and one half of the antenna tuning capacitor are in series. To do this, place a grounding jumper to the rotor of the antenna tuning capacitor, connect the antenna to one end of the antenna coil, connect one stator of the tuning capacitor to the other end of the antenna coil and disconnect the other stator completely. (Place a piece of insulation material between the tap rotor and the coil turns.) See illustration C., figure 2-3. In event r-f voltage appears on the cabinet, it can be minimized by extending the ground wire to  $1/2$  wave length and series tuning it until resonance is obtained.

f. **END FED HALF WAVE.** - This tuner can be used to tune this type of antenna also. Parallel tuning should be employed for this type operation. The antenna should be connected to one end of the antenna coil, a ground connection should be made to the inside turn of one of the antenna coils and the little jumper on top of the coils should be closed. The tuning capacitor taps should be equally spaced from each end of the antenna coils for proper tuning at the operating frequency. See illustration D., figure 2-3.

## SECTION 3

ADJUSTMENT AND OPERATION3.1. ADJUSTMENT.

3.1.1. 600 v - 700 v SWITCH. - This switch, located in the primary of the power transformer, has been placed at the rear of the transmitter to select output voltages of either 600 or 700 volts. It is recommended that this switch be placed in the 600 volt position for initial adjustments.

3.1.2. CALIBRATION. - To check dial calibration, proceed as follows:

- (a) Turn the equipment ON as outlined in steps (a) and (b) paragraph 3.2.3.
- (b) Tune a communications receiver to WWV at 10 mc. The BFO in the receiver should be OFF.
- (c) Rotate the BAND switch to 80 meter band. (lowest scale)
- (d) Rotate the TUNING dial to 4.0 mc.
- (e) Rotate the CW-CAL-PH control to CAL. This turns the VFO, buffer, first and second multiplier stages ON so that a calibration signal can be heard. Close the telegraph key.
- (f) Continue to rotate the TUNING dial about 4.0 mc until the calibration signal is zero beat with WWV.
- (g) Turn the FIDUCIAL screw until the hair line is on 4.0 mc.
- (h) In like manner, the dial can be calibrated on 15,000 kc by setting the communications receiver at WWV on 15 mc and the 32V-2 TUNING dial at 15 mc on the 20M BAND position. See the following table.

<u>WWV</u> <u>Frequency</u>	<u>Dial</u> <u>Setting</u>	<u>Oscillator</u> <u>Frequency</u>	<u>Oscillator</u> <u>Harmonic</u>
10 mc	4,000	2,000	5th
15 mc	15,000	1,875	8th
15 mc	7,500	1,875	8th

3.2. OPERATION.

3.2.1. GENERAL. - The operation of this equipment is exceedingly simple once the functions of the controls are understood. The function of the controls is hereby given, followed by a step-by-step procedure for operating the equipment.

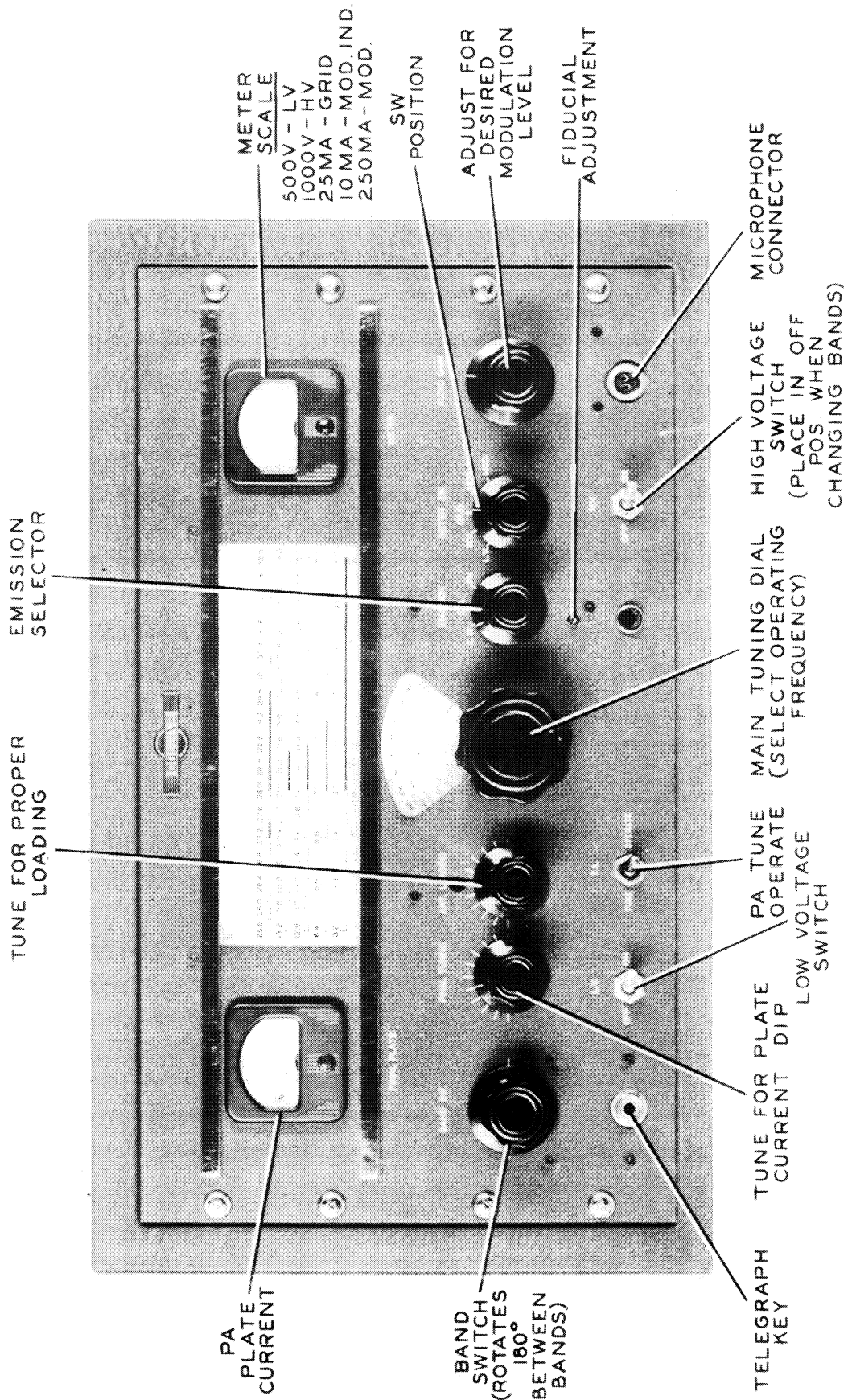

FIGURE 3-1 32V-2 CONTROL FUNCTIONS



## 3.2.2. FUNCTION OF CONTROLS.

(a) BAND SWITCH. - This control selects the proper tuning elements in all stages for the amateur band upon which operation is desired. The knob rotates 180 degrees between adjacent bands. Clockwise rotation selects higher frequency bands. The band selected is indicated by the band lighted slide rule dial.

(b) TUNING Control. - This control operates both the slide rule dial and the vernier dial to select the exact frequency upon which operation is desired.

(c) CW-CAL-PH Switch. - This three position switch selects the type of emission required. In the CW position, the secondary of the modulation transformer is short circuited, the screen voltage is removed from the modulator tubes, a bleeder is placed between the PA screen grid to ground and the carrier-control relay is connected so that it can be operated by the HV switch. The transmitter is ready for CW operation when the key is inserted in the KEY jack. In the CAL position, the VFO, buffer, first and second multiplier stages are in operation to supply a signal of suitable strength for zero-beating against received signals without causing interference to other stations. The carrier control relay is disconnected from the HV switch so that the associated receiver and antenna changeover relay will be in the "Receive" condition. In the PH position, the switch opens the short circuit on the secondary of the modulation transformer, closes the keying circuit, applies screen voltage to the modulator tubes and connects the carrier control relay so that it can be operated by the HV switch or a push-to-talk switch on a microphone.

(d) METER Switch. - The METER switch selects various circuits to be metered by the meter directly above the switch. This meter has 3 scales: 0-250; 0-500 and 0-1000. The table below indicates how it is used:

<u>METER SWITCH POSITION</u>	<u>CIRCUIT METERED</u>	<u>FULL SCALE DEFLECTION READS</u>
LV	Low voltage	500 volts
HV	High voltage	1000 volts
GRID	PA grid current (DC)	25 ma
MOD IND	Mod. grid current	10 ma
MOD	Mod. plate current	250 ma

The meter on the left reads PA Plate current only. Full scale deflection reads 500 ma.

(e) AUDIO GAIN. - This control adjusts the level of modulation in phone operation and the volume of the sidetone signal in CW operation.

(f) LV Switch. - The LV switch turns the filaments and the low voltage plate and bias supply on. (Plate voltage is not applied to the r-f exciter tubes; however, until the HV switch is turned on, except when the CW-CAL-PH switch is on CAL position.)



(g) HV Switch - The HV switch turns on the high voltage supply and connects plate voltage to the r-f exciter tube thru operation of carrier control relay K301. The push-to-talk connections are in parallel with this switch.

(h) FINAL TUNING. - This control is used to obtain resonance of the PA plate circuit. It must be reset after each adjustment of the ANT. LOADING controls.

(i) ANT. LOADING. - This control is used to obtain correct antenna tuning and loading. Start with this control in position number 1. Usually the 80 meter band will load up on positions 1, 2, or 3, the 40 meter band on 4, the 20 meter band on 5, the 15 meter band on 6, and the 10 and 11 meter bands on position 6 of the loading control.

(j) TUNE-OPERATE SWITCH. - This switch inserts some resistance in the primary of the power transformer in the TUNE position to reduce plate voltage during the tuning procedure. This switch should always be used to protect the power amplifier tube in off resonance conditions.

(k) FIDUCIAL. - This control, a small screwdriver adjustment located directly under the CW-CAL-PH knob, is used to move the vernier dial index during calibration adjustments. Once it has been set, further adjustment will be unnecessary over long periods of time.

(l) 600 - 700 v SWITCH. - This switch, located at the rear of the chassis, is used to select either 600 or 700 volts (approx.) for application to the PA plate.

(m) SIDETONE PITCH. - The sidetone pitch control is located within the cabinet near the modulator tubes. This adjustment should be set at the position which produces the most desirable tone according to individual taste.

### 3.2.3. OPERATION PROCEDURE.

(a) Operate the LV switch to the ON position. Allow two minutes for the tubes to heat.

(b) Turn the AUDIO GAIN to the counterclockwise stop. (off)

(c) Turn the ANT. LOADING control to position 1. (minimum loading)

(d) Place the CW-CAL-PH control in the position indicating the desired emission.

(e) Rotate the BAND switch to the band containing the desired operating frequency.

(f) Rotate the TUNING dial to the desired frequency.

(g) Place the METER selector switch in the GRID position and close the telegraph key. (If PH emission was selected, it will not be necessary to close the key.)

(h) Place the TUNE-OPERATE switch in the TUNE position.

(i) Observing the FINAL PLATE meter, turn the HV switch ON and quickly turn the FINAL TUNING to resonance, i.e. minimum plate current dip.

(j) Observe the GRID current reading on the right hand meter. This should be between 5 and 15 ma.

(k) Operate the ANT. LOADING control clockwise until approximately 125 ma loading is obtained and return the FINAL TUNING to resonance. Repeat this procedure until 125 ma reading is obtained with complete resonance of PA. If it is impossible to load to 125 ma PA plate current, rotate the ANT. LOADING control clockwise until proper loading is obtainable.

(l) Place the TUNE-OPERATE switch in the OPERATE position and load the PA to 180 ma with the ANT. LOADING Control maintaining resonance with the FINAL TUNING control.

#### WARNING

Operation of this equipment involves the use of high voltages which are dangerous to life. Observe all safety regulations. Do not change tubes or make adjustments inside equipment with the high voltage supply ON. Do not depend upon door interlocks for protection but always turn the high voltage supply OFF. SWITCH TO SAFETY.

(m) If CW emission was selected, the telegraph key can be opened and the transmitter keyed. If PH (phone) emission is selected, turn the METER switch to MOD. and observe the static (resting) modulator plate current. This should be about 50 ma for the 600 v position of the 600 - 700 v switch at rear (55 ma on the 700 v position). Advance the AUDIO GAIN control while speaking in normal tones into the microphone until the modulator plate current swings to about 100 ma on peaks. This will result in approximately 100% modulation with voice input. If desired, a more exact check of modulation level can be made with an oscilloscope while observing the proper meter swing for the voice of the individual operator.

With sine wave input, the modulator plate current will read about 200 ma for 100% modulation.

With the METER switch set to MOD. IND., a slight kick of the needle indicates approximately 100% modulation on voice peaks. This is useful as an alternate method of indicating modulation level, since no deflection occurs on the meter until the modulation level reaches approximately 55%. The level at which the meter kicks depends somewhat upon the loading of the final amplifier and characteristics of the modulator tubes.

## NOTE

In step (g) above, the key plug can be pulled from the key jack since this is a closed circuit type jack.

## CAUTION

When changing BANDS, place the HV switch in the OFF position. Also place the PUSH-TO-TALK switch in the OFF position.

## NOTE

If the 600 - 700 v switch is placed in the 700 v position, the PA plate current should be 220 ma.

## 3.2.4. TYPICAL METER READINGS. (PH position without modulation.)

	<u>LV</u>	<u>HV</u>	<u>GRID</u>	<u>MOD</u>	<u>FINAL PLATE BOTH PHONE &amp; CW</u>
600 v	240	580	10	50	180
700 v	240	720	10	50	220

3.2.5. DIAL CALIBRATION. - When changing BANDS, the proper scale on the slide rule dial is illuminated automatically as the BAND switch is rotated. At the same time, the vernier dial fiducial moves up or down the vernier dial face and stops at the corresponding scale to which the slide rule dial is positioned.

The dial is read by combining the vernier dial reading with the slide rule dial reading. The exact method varies somewhat from the low frequency bands to the high frequency bands and can best be learned by referring to figure 3-2.

3.2.6. ANTENNA LOADING TABLE. - This table indicates the approximate position for the antenna loading control for loading into various antenna impedances on the different bands.

POSITION OF ANT. LOADING CONTROL (for resistive loads)				
FREQ MC	26 ohm LOAD	50 ohm LOAD	100 ohm LOAD	600 ohm LOAD
3.5	2	2	2	2
4.0	3	3	3	4
7.0	4	4	4	4
7.3	4	4	4	4
14.0	5	5	5	5
14.4	5	5	5	5
21.0	6	6	6	6
21.45	6	6	6	6
27.2	6	6	6	6
28.0	6	6	6	6
29.7	6	6	6	6

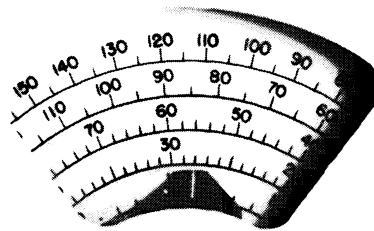
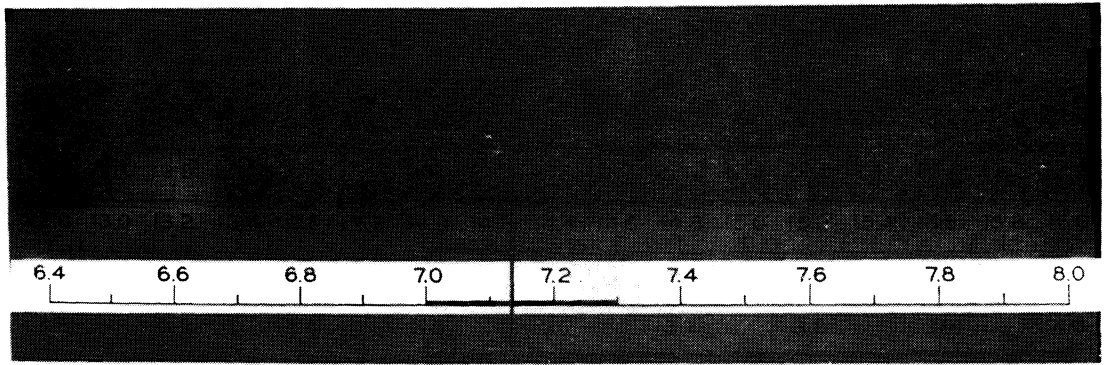

FREQ. = 7128 KC

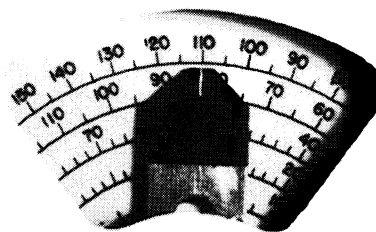
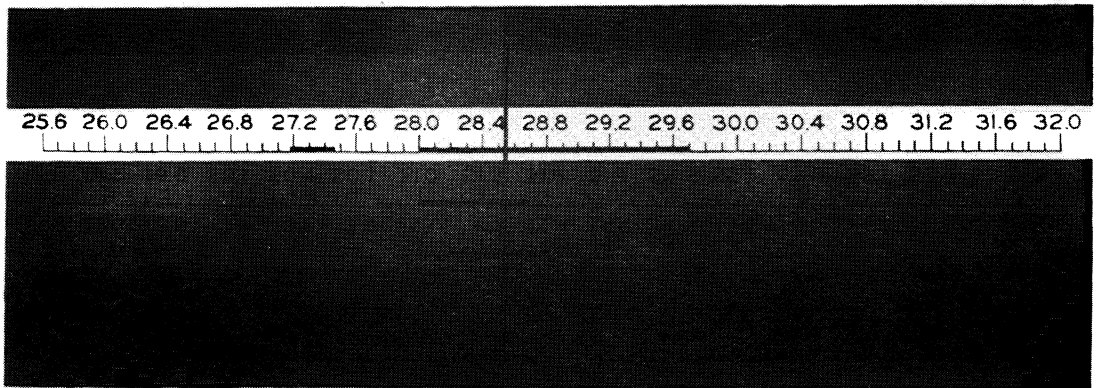

FREQ. = 28510 KC

FIGURE 3-2 TYPICAL DIAL READINGS



## SECTION 4

CIRCUIT DESCRIPTION

4.1. GENERAL. - The following paragraphs have been written to enable the owner of a 32V-2 to understand the functioning of his transmitter more fully. This section should be read and understood before any extensive servicing is attempted.

4.2. CIRCUIT DESCRIPTION.

## 4.2.1. RF CIRCUITS.

(a) OSCILLATOR - A type 6SJ7 tube is employed in a highly stabilized master oscillator circuit to generate the controlling radio frequency voltage. This frequency generating unit is a linearly - tuning permeability tuned oscillator with a range of 1.6 to 2 megacycles. Sixteen turns of the main tuning dial cover this range. This provides 50 KC per revolution of the second harmonic (3.2 to 4 mc band). With the end points properly set up, the tuning curve is linear within one dial division of the ideal tuning curve on any of the bands in the operating range. The oscillator circuit is compensated for temperature changes and is entirely enclosed in a heavy aluminum case.

(b) INTERMEDIATE STAGES. - Following the master oscillator, a type 6AK6 is employed in an untuned, Class A amplifier stage. This stage completely isolates the master oscillator from the remaining tuned stages. The 6AK6 drives a series of three frequency multiplier tubes, the first of which is a type 6AG7. The operating frequencies at the plate of the multiplier tubes for the different bands is given in the following table:

	1ST MULT. <u>6AG7</u>	2ND MULT. <u>7C5</u>	3RD MULT. <u>7C5</u>
80M	3.5 mc	3.5 mc	3.5 mc
40M	3.5 mc	3.5 mc	7 mc
20M	3.5 mc	7 mc	14 mc
15M	5.75 mc	10.5 mc	21 mc
11M	6.8 mc	13.6 mc	27 mc
10M	7 mc	14 mc	28 mc

Plate screen and filament power for these stages is obtained from the low voltage power supply. Gang tuning of the multiplier stages is obtained by moving powdered iron cores, attached to a common platform, in and out of the plate coils which are wound to give linear tuning. This platform to which the iron cores are attached is also ganged to the master oscillator tuning for complete, single control tuning of the exciter stages. Band switching is accomplished by adding extra padding capacity across coils by means of the band switch in all cases **excepting** the 14 mc output of the third multiplier where an inductance is switched in in parallel with the existing 40 meter inductor to lower the tuning inductance for 14 mc output.

(c) POWER AMPLIFIER STAGE. - A type 4D32 tetrode power amplifier tube is used

in the PA stage. This tube always operates as a straight amplifier. The plate circuit is tuned by a combination pi-network and "L" network which is band-switched along with the multiplier stages. The combination network reduces the output impedance to around 50 ohms on all bands by means of inductance and capacitance switching. The output network will actually operate satisfactorily with antenna impedances in the range 26 to 600 ohms. It is also effective in reducing harmonic output of the transmitter. The screen grid and plate of the 4D32 are both modulated in phone transmission. Plate and screen voltage is obtained from the high voltage supply while filament power is obtained from the low voltage plate supply transformer. The tube is biased with 75 volts of fixed-bias plus some grid leak bias.

4.2.2. AUDIO CIRCUITS. - The first and second audio amplifier consists of a type 6SL7 tube operated as a cascade amplifier. A volume control, R205, is located in the grid circuit of the second amplifier stage. The driver stage employs a type 6SN7 tube with the two triode sections operated in parallel to drive the modulator stage. The modulator stage utilizes a pair of type 807 tubes connected in a push pull circuit and operating class AB<sub>2</sub>. The output of the modulator is coupled to the final amplifier by transformer, T202, to modulate the plate and screen of that stage. During CW operation, the secondary of the modulation transformer is shorted out by S302A. Bias for the modulator tubes is adjustable by R305, and obtained from the low voltage supply and regulated by the voltage regulator tube, V304, type VR-75. The secondary of the modulation transformer has a 500 ohm tap provided for supplying 60 watts of audio power to an external load.

4.2.3. HIGH VOLTAGE SUPPLY. - The high voltage transformer is energized when the contacts of relay, K301, are closed. The high voltage supply employs two type 5R4GY rectifier tubes connected in parallel in a full wave circuit. The output is filtered by a single section choke input filter. This supply furnishes voltage for the plate and screen of the final amplifier and plate voltage for the modulator tubes. The amount of output voltage from this supply may be either 600 volts or 700 volts depending on the position of the tap switch, S305, in the primary winding of the high voltage transformer, T302. For the same power input, the efficiency of the final amplifier improves with the higher operating voltage. The tube manufacturer recommends no more than 600 plate volts for phone operation, but this is for CCS rating. A pair of 15 ohm resistors are connected in series with the HV plate transformer primary for "tune-up". These are shorted out when operating.

4.2.4. LOW VOLTAGE SUPPLY. - Transformer, T301 furnishes power for both the low voltage plate supply and the filament of all tubes in the transmitter. T301 is energized by closing the LV switch, S304. Three separate windings on transformer, T301, furnishes filament power to the tubes. The low voltage plate supply employs a type 5Z4 rectifier tube in a full wave circuit with a two section choke input filter. This supply has a total output voltage of approximately 315 volts, 240 volts is supplied to the audio amplifier, oscillator, buffer and multiplier stages. Bias voltage for the modulator and final amplifier stage is furnished by this supply. It also supplies voltage for the operation of relay, K301.

4.2.5. RECEIVER MUTING CIRCUIT. - Users of the Collins Model 75A receiver can take advantage of the cw muting circuit contained therein. This muting is accomplished by blocking the noise limiter circuit in the receiver with a positive voltage. In the 32V-2 transmitter this positive voltage is obtained from the voltage drop across the cathode resistor of the second multiplier tube, V103. The receiver limiter switch should be in the OUT position during CALIBRATION adjustments of the 32V-2.





## SECTION 5

MAINTENANCE5.1. INSPECTION.

5.1.1. GENERAL. - This radio equipment has been constructed of materials considered to be the best obtainable for the purpose and has been carefully inspected and adjusted at the factory to reduce maintenance to a minimum. However, a certain amount of checking and servicing will be necessary to maintain efficient and dependable operation. The following section has been written to aid in checking the equipment.

5.1.2. ROUTINE INSPECTION. - Routine inspection schedules should be set up for periodic checks of this equipment. This inspection should include examination of the mechanical system for excessive wear or binding and of the electrical system for electrical defects and deterioration of components.

If the routine inspection of the equipment is carried out faithfully, the chances of improper operation of the equipment are greatly minimized. It is suggested that this inspection be made as frequently as possible and it should be sufficiently thorough to include all major electrical circuits of the equipment as well as the mechanical portion.

(a) CLEANING. - The greatest enemy to uninterrupted service in equipment of this type is corrosion and dirt. Corrosion, itself, is accelerated by the presence of dust and moisture on the component parts of the assembly. It is impossible to keep moisture out of the equipment in certain localities, but foreign particles and dust can be periodically removed by means of a soft brush and a dry, oil-free jet of air. Remove the dust as often as a perceptible quantity accumulates in any part of the equipment. It is very important that rotating equipment, such as variable condensers and tap switches, be kept free from dust to prevent undue wear. Likewise, variable condenser plates should be kept free from dirt to avoid flashover.

One of the greatest sources of trouble in equipment located in a salt atmosphere is corrosion. Corrosion resulting from salt spray or salt laden atmosphere may cause failure of the equipment for no apparent reason. In general, it will be found that contacts such as tap switches, tube prongs, cable plug connectors, and relay contacts are most affected by corrosion. When it is necessary to operate the equipment in localities subject to such corrosive atmosphere, inspection of wiping contacts, cable plugs, relays, etc., should be made more frequently in order to keep the equipment in good condition.

(b) VACUUM TUBES. - Make a check of emission characteristics of all tubes. After the emission check, examine the prongs on all tubes to make sure that they are free from corrosion. See that all tubes are replaced correctly and fully in their sockets, and a good electrical contact

is made between the prong of the tube and the socket. Use caution in removing and replacing grid or plate caps on tubes so equipped. Before a tube is discarded, make certain that the tube is at fault and the trouble is not a loose or broken connection within the equipment. A complete set of tested tubes of the same type specified should be kept on hand at all times. If faulty operation of the transmitter is observed and tube failure suspected, each tube may be checked by replacing it with a tube known to be in good condition. Defective tubes causing an overload in power circuits may usually be located by inspection. It will be found that excessive heating or sputtering within the vacuum tubes is a good indication of a fault in the tube circuit.

If tubes have been in use for a period of time equal to or exceeding the manufacturer's tube life rating, it is suggested that they be replaced. A marked improvement in the performance of the equipment is usually noticeable after the weak tubes have been replaced.

(c) PRECAUTIONS FOR SATISFACTORY TUBE LIFE.

(1) Before any tube is removed from the equipment, make certain the primary power is disconnected from the equipment.

(2) Operate all tubes within  $\pm 5\%$  of rated filament voltage.

(3) Do not exceed the rated plate current of any tube during normal operation of the equipment.

(d) TUBE REPLACEMENT PRECAUTIONS.

(1) All tubes are removed by pulling them straight away from the chassis.

(2) Remove plate cap connectors, from tubes so equipped, with great care to prevent breaking the seal around the plate cap.

(3) Before a tube is inserted, make certain that the type of tube is correct for the socket into which it is being placed.

N O T E

Changing master oscillator tubes (V001) may cause a slight change in master oscillator calibration.

(e) TUBE TABLE.

<u>SYMBOL</u>	<u>TYPE</u>	<u>FUNCTION</u>	<u>RATED FIL. VOLTAGE</u>
V001	6SJ7	Master oscillator	6.3
V101	6AK6	Buffer amplifier	6.3
V102	6AG7	Frequency multiplier	6.3
V103	7C5	Frequency multiplier	6.3

TUBE TABLE

<u>SYMBOL</u>	<u>TYPE</u>	<u>FUNCTION</u>	<u>RATED FIL. VOLTAGE</u>
V104	705	Frequency multiplier	6.3
V105	4D32	Power Amplifier	6.3
V201	6SL7	Audio Amplifier	6.3
V202	6SN7	Audio driver	6.3
V203	807	Modulator	6.3
V204	807	Modulator	6.3
V205	6SL7GT	Sidetone Oscillator	6.3
V301	5Z4	LV Rectifier	5.0
V302	5R4GY	HV Rectifier	5.0
V303	5R4GY	HV Rectifier	5.0
V304	VR75	Bias Regulator	---
V305	0A2	Screen Voltage Limiter	---
V306	0A2	Screen Voltage Limiter	---

(f) RELAYS. -- All relays should be inspected at regular intervals. Check the contacts for proper alignment, pitting and corrosion. Use a burnishing tool to clean contacts -- never use sandpaper or emery cloth.

5.2. TROUBLE SHOOTING.

5.2.1. GENERAL. -- The most general cause of improper operation of radio equipment is tube failure. Refer to paragraph 5.1.2., (b) in this section for comments concerning vacuum tube replacement. Defective tubes causing an overload in power circuits may usually be located by inspection. High voltage arcs may be caused by bent condenser plates, corrosion or dust. Corrosion resulting from operating the equipment in a salt laden atmosphere may cause failure of the equipment for no apparent reason.

In general, trouble encountered in radio apparatus may be isolated by means of various tests and measurements, and the section of the transmitter determined in which the trouble is located. If this is done, the components in the associated circuit may be checked and the trouble located. Refer to the tables of meter readings and resistance measurements.

No one but an authorized and competent service man equipped with proper test facilities should be permitted to service this equipment.

5.2.2. FUSES.

(a) GENERAL. -- This equipment is supplied with fuses of the correct rating in each position. Fuse failures should be replaced with spares only after the circuit in question has been carefully examined to make certain that no permanent fault exists. Always replace a fuse with the rating specified in the following table:

FUSE TABLE

<u>SYMBOL</u>	<u>LOCATION</u>	<u>TYPE</u>	<u>RATING</u>
F301	LV Power supply primary	Cartridge (3AG)	3 amp.
F302	HV Power supply primary	Cartridge (3AG)	5 amp.

### 5.3. ALIGNMENT.

5.3.1. GENERAL. - Should, for any reason, the exciter stages get out of alignment, it is recommended that the unit be realigned at once. Improper operation might result in damage to valuable equipment.

5.3.2. HIGH FREQUENCY OSCILLATOR. - Should trouble develop in the high frequency master oscillator, the unit should be returned to the factory for servicing. However, the unit can be serviced and realigned by persons understanding such techniques providing accurate test equipment is at hand. A crystal controlled frequency standard with outputs at 1700 and 2000 kc with an accuracy of better than .015 percent, must be used for setting the band edges.

#### (a) PROCEDURE.

(1) Apply power to the transmitter and let the MO warm up for about 30 min. then check the oscillator frequency on a receiver. Operate the transmitter with the emission control in the CAL position and the key closed.

(2) Couple a receiver to the output of the oscillator.

(3) Set the vernier index to exact center of the dial window.

(4) Tune receiver to output of 1700 kc freq. standard.

(5) Rotate MO to vicinity of 3400 kc on the exciter dial and zero beat with the signal from the standard. Write dial reading down for use as a reference.

(6) Rotate the MO dial toward 4 mc exactly 12 turns.

(7) Tune the receiver to the 2000 kc output of the standard.

(8) The MO should zero beat with the 2000 kc output of the standard at exactly 12 turns of the MO dial.

(9) If such is the case but the dial reading is incorrect, loosen the set screws in the oscillator coupler and turn the dial to the correct reading (4000 kc) after which tighten the set screws again. If the MO does not zero beat with the standard at 4 mc, proceed as follows:

(10) Read the kc difference (the difference of where the signal appeared from where it should have appeared after 12 turns) and multiply it by 5. Add this figure to the actual beat note dial setting if the beat note was less than 12 turns or subtract it if the beat note occurred at more than 12 turns. Now set the dial to this new frequency, remove the trimmer plug from the top of the oscillator, and turn the adjustment until zero beat is again reached. It will be found that the high and low ends are very nearly 12 turns apart. Repeat the above procedure until such is the case; remember that a new reference point will occur at the low end of the dial each time.

Examples of above operations:

#1

Beat note at low end of dial	= 3402 kc
Reading at which beat note should appear after 12 turns of dial	= 4002 kc
Actual dial reading	= 4003 kc
Difference frequency (4003 - 4002)	= 1 kc
Multiplied by 5	= 5 kc
Subtracted from 4003 (since beat note occurred at more than 12 turns)	= 3998 kc

After setting dial to 3998 kc and zero beating the MO to the standard with the trimmer adjustment, the low end beat note should appear at 3398 kc.

#2

Beat note on low end of dial	= 3498 kc
Reading at which dial should appear after 12 turns	= 3998 kc
Actual dial reading	= 3996 kc
Difference frequency (3998 - 3996)	= 2 kc
Multiplied by 5	= 10 kc
Added to 3996 (since beat note occurred at less than 12 turns of the dial)	= 4006 kc

After setting the dial at 4006 and zero beating the MO to the standard with the trimmer adjustment, the low end beat note should appear at 3406 kc.

(11) After the oscillator has been adjusted to cover the range 3400 to 4000 kc in exactly 12 turns, the coupler set screws can be loosened and the dial set on frequency.

NOTE

The above method of adjustment is that which is used at the factory. This is a short cut method and proves very reliable. Actually, the object is to get the 1700 kc and the 2000 kc outputs of the oscillator exactly 12 turns apart and it can be attained by using the slower method of moving the trimmer capacitor in one direction or the other and checking the results until the desired answer is obtained. Be sure to replace the trimmer cover plug after alignment.

NOTE

Somewhat greater accuracy can be obtained if the oscillator end points are set using harmonic operation i.e. listen in the 14 or 28 mc region for the harmonics of the 1700 and 2000 kc signals and set the corresponding harmonic of the MO to zero beat with these. Do this only after obtaining a very close adjustment as outlined above.

5.3.3. MULTIPLIER STAGES. - Should the grid drive to the final fall below 5 ma on the meter due to change of tubes or aging of components, the transmitter r-f circuits should be realigned. Proceed as outlined below only after the master oscillator has been checked and recalibrated as outlined in paragraph 5.3.2.

A small fiber screwdriver and a 1/4" open end wrench are required for these adjustments.

(a) PROCEDURE.

(1) Remove the transmitter from the cabinet and tip it up on end. (RF section up).

(2) Remove the fuse from the HV primary. (This allows the low voltage supply to be turned on while the HV supply remains turned off.)

(3) Turn the LV and HV power switches ON.

(4) Place the CW-CAL-PH switch in the PH position.

(5) Place the METER selector switch in the GRID position.

(6) Adjust for maximum grid current using the adjustments and conditions listed below in order from top to bottom of the list. (Refer to figure 5-1 for adjustment identification.)

<u>ORDER OF ADJUSTMENT</u>	<u>BAND SW SET AT</u>	<u>TUNING SET AT</u>	<u>ADJUSTMENT</u>
1	10M	28,800	3 Slugs marked "28.8"
2	40M	7,300	C150
3	40M	7,200	1 Slug marked "7.2"
4	15M	21,600	3 Trimmers marked "21.6"
5	20M	14,250	3 Trimmers marked "14.4"
6	80M	3,750 kc	1 Trimmer marked "3.6"

NOTE

In item 4 under ADJUSTMENT, the mistracking of the third multiplier plate circuit will result in low grid current when the main tuning dial is set much outside the limits of the amateur 20 meter band (14 to 14.4 mc). Proper grid current can be obtained at any frequency on the range 12.8 - 16 mc by adjustment of trimmer C137 (marked 14.4) on the third multiplier.

NOTE

If extensive multiplier alignment has been necessary, it is likely that the two spurious signal traps will need tuning. Do not touch the spurious signal tuning condensers unless this is so, since these adjustments are

very critical. The spurious signal trap tuning condenser for the 80 meter band, C149 is located on the side of the multiplier unit next to C150, see figure 5-4. These traps are tuned as follows: With the transmitter aligned as indicated in the above paragraphs, tune the transmitter for 3.5 mc output and listen with a receiver to the 1.75 mc output. Watching the receiver "S" meter, tune C147 for minimum signal. Then tune the transmitter up on 7.15 mc and listen on 3.575 mc with the receiver. Adjust C149 for minimum signal. Both of these adjustments will be very sharp and care should be taken that they are not disturbed in the least after the adjustments have been made. Replace the multiplier bottom cover.

5.3.4. MODULATOR BIAS ADJUSTMENT. - The modulator bias can be adjusted by turning the screwdriver slot equipped potentiometer R305. For best distortion characteristics, the static, or resting, modulator plate current should be 55 ma with the 600 - 700 v switch in the 700 v position. Potentiometer R305 is located within the top of the cabinet near the filter capacitors, therefore, the interlock switch will have to be held closed while making this adjustment. Take great care to avoid touching any components carrying high voltage.

The proper bias for the modulator grids is approximately minus 25 volts.

5.4. LUBRICATION. - The following parts should be lubricated annually or whenever the need arises by brushing a thin film of the indicated lubricant on the points of mechanical contact. Don't over-lubricate.

(a) PA Bandswitch Contacts: MOBILE PD535A (Socony Vacuum Oil Co.)

(b) Panel Bushings: MOBILE PD535A (Socony Vacuum Oil Co.)

5.5. OSCILLATOR TUBE REMOVAL. - Replacing an oscillator tube requires the breaking of the seal around the shield and it will then become necessary to reseal the shield. If it becomes necessary to replace an oscillator tube, use a glyptal cement or a generous of Duco cement to reseal the shield.

5.6. DESICCANT CAPSULE. - A silica-gel tube is mounted on the top of the oscillator shield. The silica-gel absorbs moisture from within the oscillator and aids in retaining the oscillator calibration. Moisture causes the color of the silica-gel to change from blue to pink. The silica-gel tube is screwed into a hole in the shield. The plastic tube should be replaced by a new tube of silica-gel when all of the material within the tube has changed from blue to pink. New tubes of silica-gel may be ordered from the Collins Radio Company.

#### NOTE

The seal around the oscillator tube shield and the silica-gel tube is more easily broken if the parts are warm. This can be done safely with a light bulb or infra-red lamp placed close to the oscillator.



## TYPICAL TEST VOLTAGES

DC Voltages to Ground measured with Volt-ohmyst. Conditions: Phone -  
No Mod. Readings taken at LF end of each band.

Tube	Pin	R.F.					
		3.5	7.0	14.0	21.0	27.2	28.0
V101	6AK6						
G1	1	-17.0	-16.5	-1.0	-0.9	-1.0	-0.9
K	2, 7	1.0	1.0	2.9	2.85	2.85	2.9
P	5	235	230	230	225	225	225
G2	6	155	150	65	65	65	65
V102	6AG7						
K	1, 3, 5	2.6	2.6	3.9	3.2	3.4	3.2
G1	4	-18.	-18.	-36	-36	-38	-36
G2	6	220	215	205	205	205	210
P	8	230	230	220	220	225	225

Tube	Pin	R.F.					
		3.5	7.0	14.0	21.0	27.2	28.0
V103	7C5						
P	2	235	235	215	210	215	215
G2	3						
G1	6	-24.	-23.	-56.	-21.	-69.	-51.
K	7	25.	25.	27.	27.	26.	26.
V104	7C5						
P	2	225	220	215	215	215	215
G2	3						
G1	6	-115	-110	-170	-175	-150	-150
K	7	-59	-56	-52	-52	-51	-50
V105	RK-4D32						
G2	2	285	300	300	300	295	295
K	4, 5	0	0	0	0	0	0
G1	6	-120	-100	-93	-105	-105	-102
P	Cap	690	680	690	690	690	690

DC Voltages to Ground in Audio System (Volt-ohmyst)

4D32 Plate Current = 220 MA

$E_p = 700$  V

Key Down

Audio Amplifier V201, 6SL7GT				Driver V202, 6SN7GT			Modulator V203, & 4, 807			Sidetone Osc. V205, 6SL7GT		
Pin		PH	CW		PH	CW		PH	CW		PH	CW
1	G	-0.6	-0.8	G	0	0	G	-0.5	-3.0	G	-0.5	-3.0
2	P	88.	-0.9	P	235	235	G2	235	0	P	-0.8	25
3	K	0	0	K	7.4	7.4	G1	-25	-25	K	0	0
4	G	0	0	G	0	0	K	0	0	G	-0.3	-0.5
5	P	100	100	P	235	235	---	---	---	P	-0.8	24
6	K	0.8	0.8	K	7.4	7.4	P	720	740	K	0	---
7												
8												

Key up - key down conditions of V105 (4D32)	Plate E	<u>Key up</u>	<u>Key down</u>
CW operation	Plate I	820	740
f = 7 mc	Screen E	0	220
		300	300



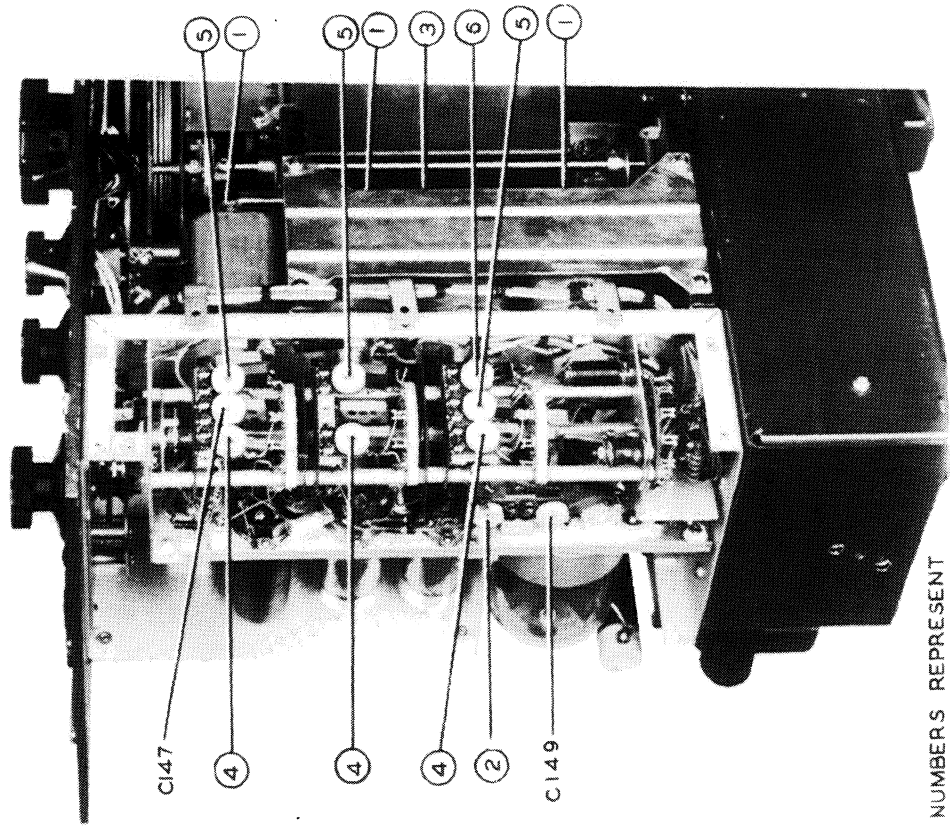

NUMBERS REPRESENT  
 ORDER OF  
 ADJUSTMENT  
 (SEE TEXT)

BOTTOM

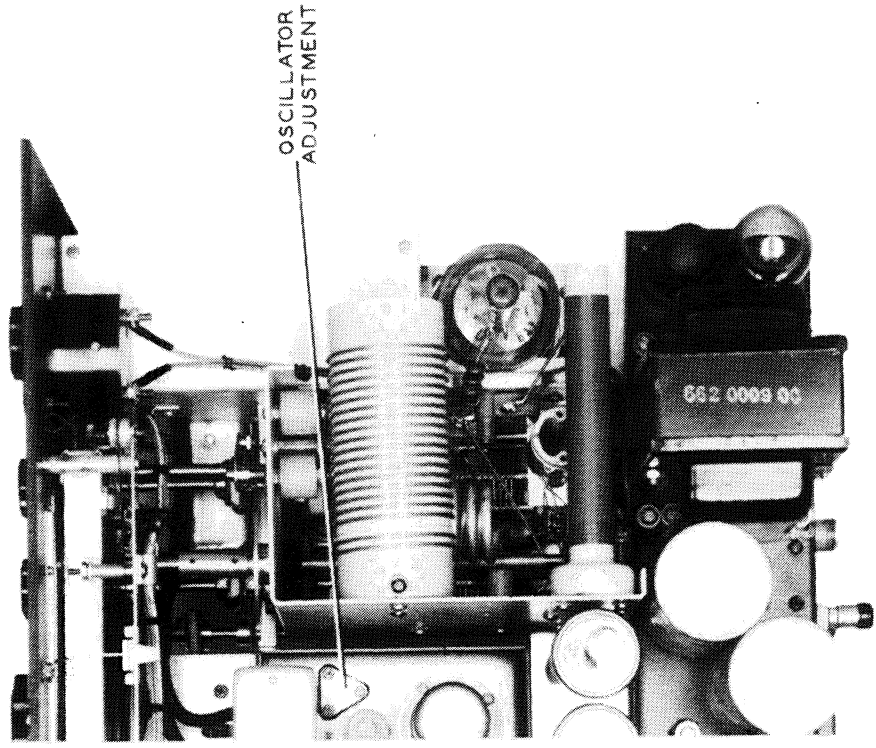

TOP

FIGURE 5--: ALIGNMENT ADJUSTMENTS



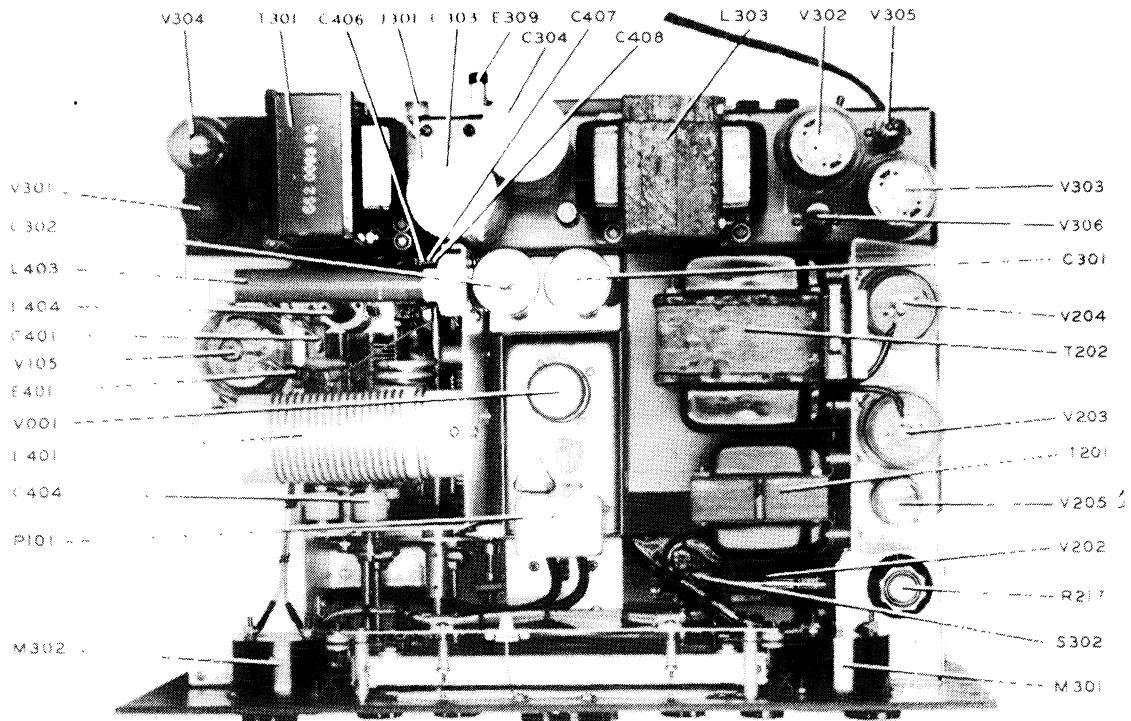

FIGURE 5-2 32V-2 PARTS ARRANGEMENT - TOP VIEW

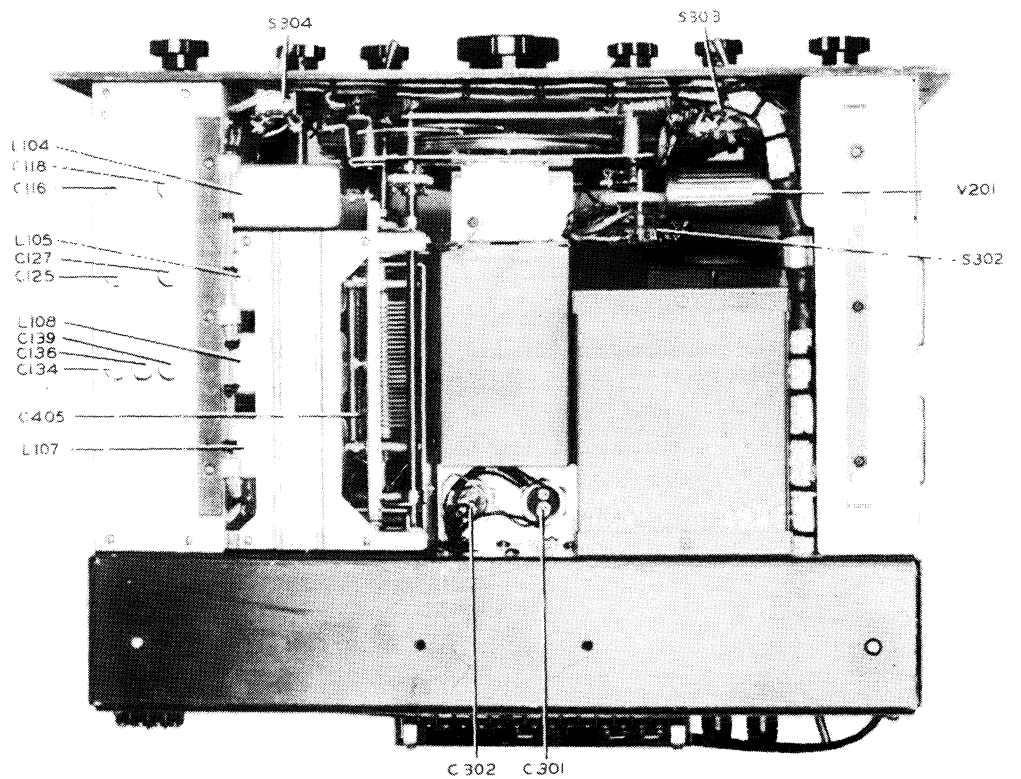

FIGURE 5-3 32V-2 PARTS ARRANGEMENT - BOTTOM VIEW



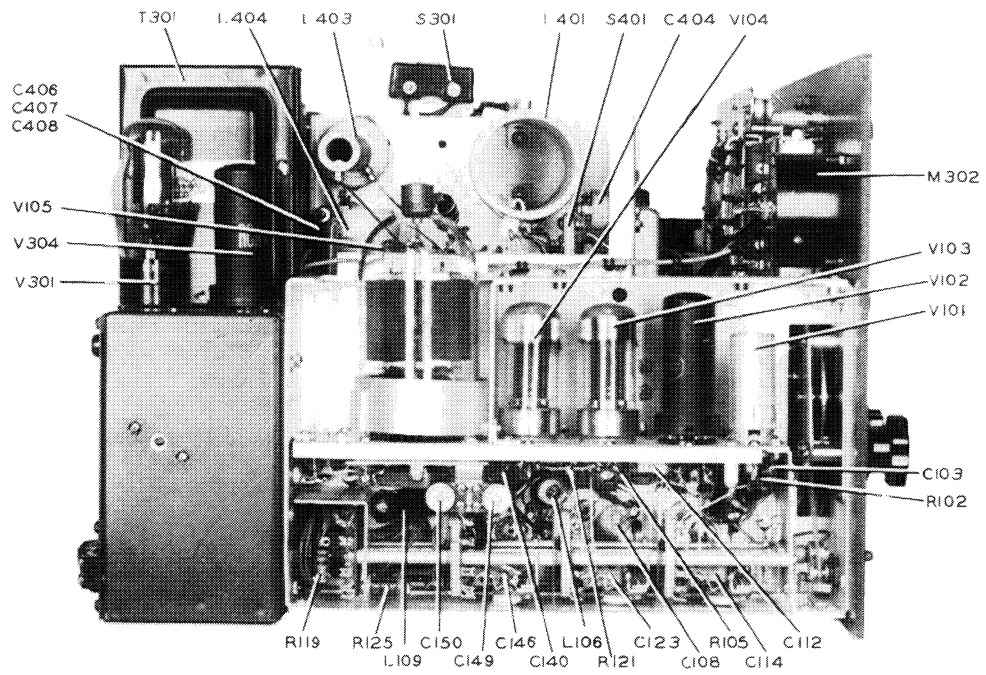

FIGURE 5-4 32V-2 PARTS ARRANGEMENT-LEFT SIDE OPEN

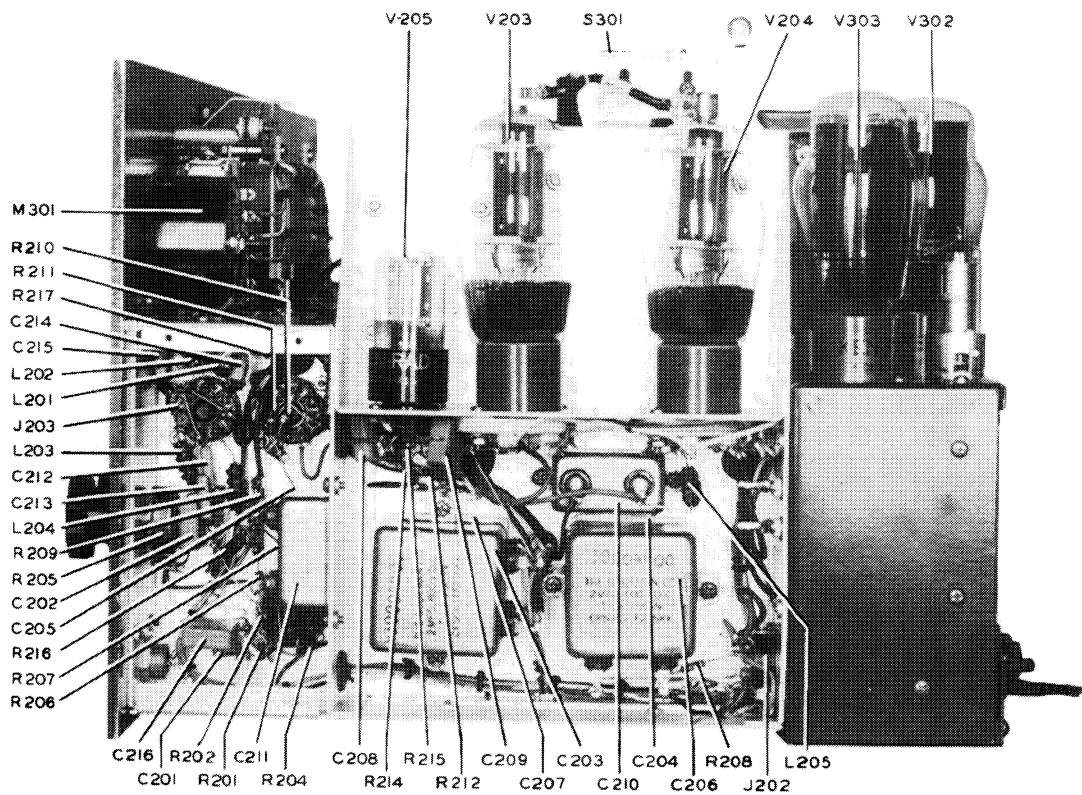

FIGURE 5-5 32V-2 PARTS ARRANGEMENT - RIGHT SIDE OPEN





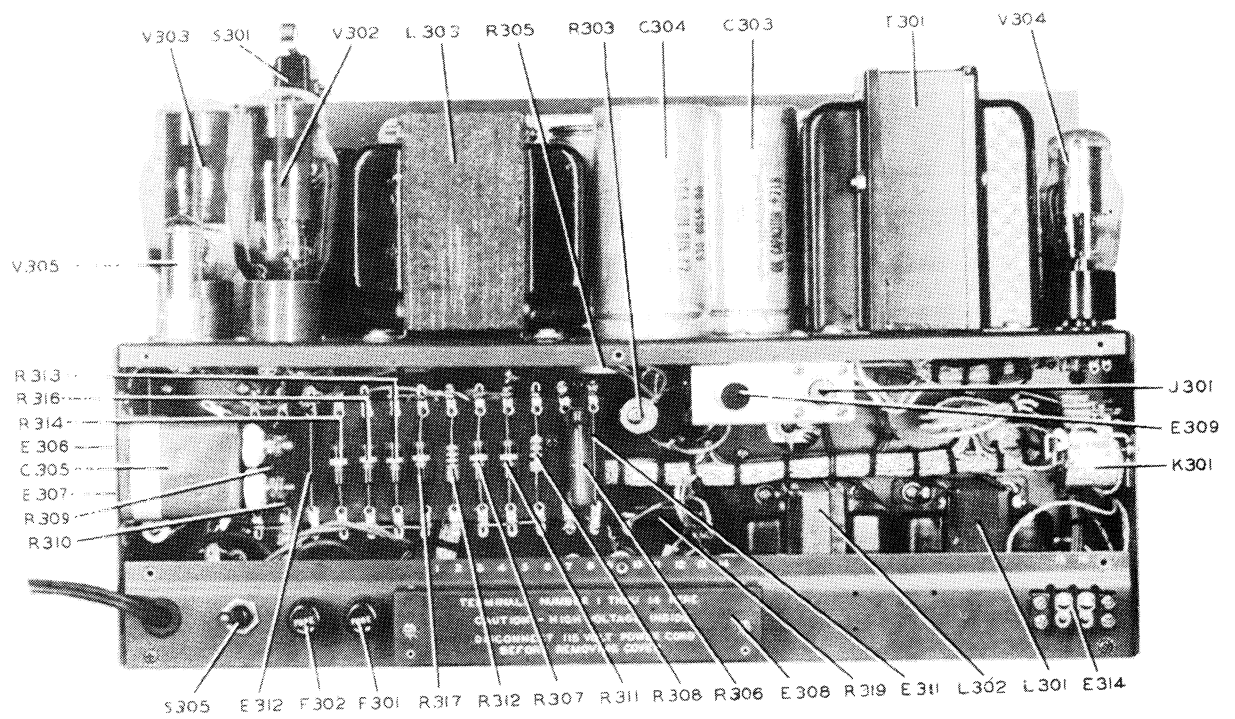

FIGURE 5-6 32V-2 PARTS ARRANGEMENT-REAR OPEN

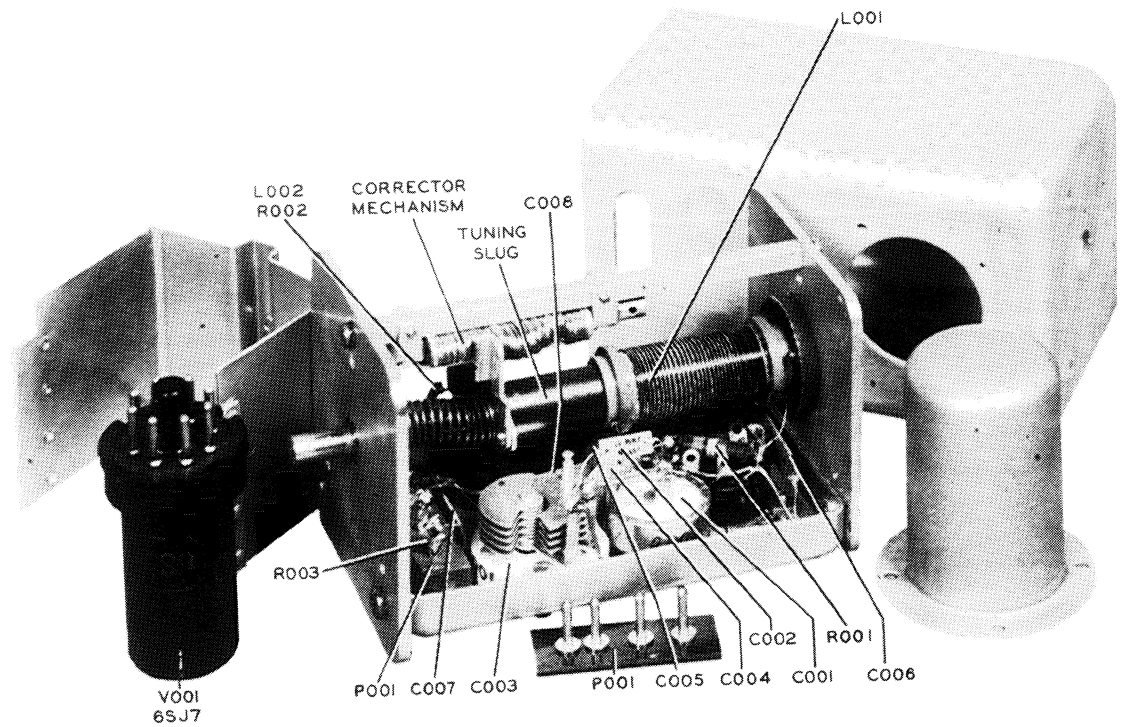

FIGURE 5-7 PARTS ARRANGEMENT 70E-8-OPEN



SECTION 6  
PARTS LIST

Section 6

32V-2

ITEM	CIRCUIT FUNCTION	DESCRIPTION	COLLINS PART NUMBER
C101	Buffer Amp. Coupling	CAPACITOR: 30 mmf $\pm 2\%$ ; 500 WV	
C102	Osc. Plate Filter	CAPACITOR: 10,000 mmf $\pm 20\%$ ; 350 WV DC	913 0106 00
C103	Buffer Grid Voltage Divider	CAPACITOR: 30 mmf $\pm 2\%$ ; 500 WV	
C104	Buffer Cathode By-pass	CAPACITOR: 10,000 mmf $\pm 10\%$ ; 300 WV	935 2117 00
C105	Buffer Screen By-pass	CAPACITOR: 10,000 mmf $\pm 10\%$ ; 300 WV	935 2117 00
C106	Buffer Plate By-pass	CAPACITOR: 10,000 mmf $\pm 10\%$ ; 300 WV	935 2117 00
C107	1st Mult. Coupling	CAPACITOR: 100 mmf $\pm 10\%$ ; 500 WV	916 4003 00
C108	1st Mult. Grid By-pass	CAPACITOR: 100,000 mmf $\pm 10\%$ ; 400 WV	931 3020 00
C109	1st Mult. Cathode By-pass	CAPACITOR: 10,000 mmf $\pm 10\%$ ; 300 WV	935 2117 00
C110	1st Mult. Screen By- pass	CAPACITOR: 10,000 mmf $\pm 10\%$ ; 300 WV	935 2117 00
C111	Key Click Filter	CAPACITOR: 10,000 mmf $\pm 10\%$ ; 300 WV	935 2117 00
C112	2nd Mult. Coupling	CAPACITOR: 100 mmf $\pm 10\%$ ; 500 WV	916 4003 00
C113	1st Mult. Plate By- pass	CAPACITOR: 650 mmf $\pm 10\%$ ; 300 WV	
C114	1st Mult. Plate Tuning	CAPACITOR: 22 mmf $\pm 5\%$ ; 500 WV	935 0077 00
C115	1st Mult. Plate Tuning	CAPACITOR: 22 mmf $\pm 10\%$ ; 500 WV	935 0078 00
C116	1st Mult. Plate Tuning	CAPACITOR: 8-50 mmf; 350 WV	917 1038 00
C117	1st Mult. Plate Tuning	CAPACITOR: 180 mmf $\pm 2\%$ ; 500 WV	
C118	1st Mult. Plate Tuning	CAPACITOR: 8-50 mmf; 350 WV	917 1038 00
C119	2nd Mult. Screen By- pass	CAPACITOR: 10,000 mmf $\pm 10\%$ 300 WV	935 2117 00
C120	2nd Mult. Screen By- pass	CAPACITOR: 10,000 mmf $\pm 10\%$ 300 WV	935 2117 00
C121	2nd Mult. Plate By-pass	CAPACITOR: 10,000 mmf $\pm 10\%$ ; 300 WV	935 2117 00
C122	3rd Mult. Coupling	CAPACITOR: 100 mf $\pm 10\%$ ; 500 WV	916 4003 00
C123	2nd Mult. Plate Tuning	CAPACITOR: 20 mmf $\pm 5\%$ ; 500 WV	935 0076 00
14211-2			6-1

## PARTS LIST

ITEM	CIRCUIT FUNCTION	DESCRIPTION	COLLINS PART NUMBER
C124	2nd Mult. Plate Tuning	CAPACITOR: 22 mmf $\pm 10\%$ ; 500 WV	935 0078 00
C125	2nd Mult. Plate Tuning	CAPACITOR: 8-50 mmf; 350 WV	917 1038 00
C126	2nd Mult. Plate Tuning	CAPACITOR: 150 mmf $\pm 2\%$ ; 500 WV	935 0184 00
C127	2nd Mult. Plate Tuning	CAPACITOR: 8-50 mmf; 350 WV	917 1038 00
C128	3rd Mult. Cathode By-pass	CAPACITOR: 10,000 mmf $\pm 10\%$ ; 300 WV	935 2117 00
C129, C130	3rd Mult. Screen By- pass	CAPACITOR: 10,000 mmf $\pm 10\%$ ; 300 WV	935 2117 00
C131, C132	3rd Mult Plate By-pass	CAPACITOR: 10,000 mmf $\pm 10\%$ ; 300 WV	935 2117 00
C133	2nd Mult Cathode By- pass	CAPACITOR: 10,000 mmf $\pm 10\%$ ; 300 WV	935 2117 00
C134	3rd Mult. Plate Tun- ing	CAPACITOR: 8-50 mmf; 350 WV	917 1038 00
C135		CAPACITOR: Not used	
C136	3rd Mult. Plate Tun- ing	CAPACITOR: 8-50 mmf; 350 WV	917 1038 00
C137	3rd Mult. Plate Tun- ing	CAPACITOR: 120 mmf $\pm 2\%$ ; 500 WV	935 0179 00
C138		CAPACITOR: Not used	
C139	3rd Mult. Plate Tun- ing	CAPACITOR: 8-50 mmf; 500 WV	917 1038 00
C140	PA Coupling	CAPACITOR: 100 mmf $\pm 10\%$ ; 500 WV	916 4003 00
C141	PA Grid By-pass	CAPACITOR: 10,000 mmf $\pm 10\%$ ; 300 WV	935 2117 00
C142	PA Screen By-pass	CAPACITOR: 1000 mmf $\pm 20\%$ ; 2500 WV	936 0250 00
C143	3rd Mult Plate Tuning	CAPACITOR: 2 mmf $\pm 1/2$ mmf; 500 WV	916 0002 00
C144	PA Filament By-pass	CAPACITOR: 500 mmf $\pm 40-15\%$ ; 500 WV	912 0302 00
C145	3rd Mult. Plate Block- ing	CAPACITOR: 10,000 mmf $\pm 10\%$ 300 WV	935 2117 00
6-2			14212-2

## PARTS LIST

## Section 6

ITEM	CIRCUIT FUNCTION	DESCRIPTION	COLLINS PART NUMBER
C146	3rd Mult. Plate Tuning	CAPACITOR: 20 mmf $\pm 5\%$ ; 500 WV	935 0076 00
C147	160 Meter Trap Tuning	CAPACITOR: 8-50 mmf	
C148	80 Meter Trap Fixed Tuning	CAPACITOR:	
C149	80 Meter Tap Var. Tuning	CAPACITOR: 8-50	
C150	L108 Trimmer	CAPACITOR: 8-50 mmf	
C201	Audio Input r-f Filter	CAPACITOR: 47 mmf $\pm 20\%$ ; 500 WV	935 0093 00
C202	Audio coupling	CAPACITOR: 10,000 mmf $\pm 10\%$ ; 300 WV	935 2117 00
C203, C204	V201 Plate bypass	CAPACITOR: 2 mf $\pm 10\%$ ; 600 WV	930 0046 00
C205	Driver grid coupling	CAPACITOR: 10,000 mmf $\pm 10\%$ ; 300 WV	935 2117 00
C206	Driver cathode bypass	CAPACITOR: 2 mf $\pm 10\%$ ; 600 WV	930 0046 00
C207	Mod. cathode bypass	CAPACITOR: 2 mf $\pm 10\%$ ; 600 WV	930 0046 00
C208	Sidetone feedback	CAPACITOR: 10,000 mmf $\pm 10\%$ ; 300 WV	935 2117 00
C209	Sidetone feedback	CAPACITOR: 10,000 mmf $\pm 10\%$ 300 WV	935 2117 00
C210	Sidetone coupling	CAPACITOR: .5 mf $\pm 20\%$ ; 600 WV	956 2086 40
C211	Audio plate decoupling	CAPACITOR: .5 mf $\pm 20\%$ ; 600 WV	956 2086 40
C212	R-F bypass	CAPACITOR: 47 mmf $\pm 20\%$ ; 500 WV	935 0093 00
C213	R-F bypass	CAPACITOR: 47 mmf $\pm 20\%$ ; 500 WV	935 0093 00
C214	R-F bypass	CAPACITOR: 47 mmf $\pm 20\%$ ; 500 WV	935 0093 00
C215	R-F bypass	CAPACITOR: 47 mmf $\pm 20\%$ ; 500 WV	935 0093 00
C216		CAPACITOR: 10,000 mmf $\pm 10\%$ ; 300 WV	935 2117 00
C301, C302	LV rect. filter	CAPACITOR: 4 mf +40 -15%; 600 WV	961 3005 00
C303,	HV rect. filter	CAPACITOR: 8 mf $\pm 20\%$ ; 1000 WV	930 0150 00
14213-4			6-3

PARTS LIST

ITEM	CIRCUIT FUNCTION	DESCRIPTION	COLLINS PART NUMBER
C305		CAPACITOR: 25 mf	
C401	PA plate blocking	CAPACITOR: 1000 mmf $\pm 20\%$ ; 2500 WV	936 0250 00
C402	PA plate bypass	CAPACITOR: 2200 mmf + 20%; 2500 WV	936 1083 00
C403	Final tuning	CAPACITOR: Dual sect; 10-150 mmf per sect	920 0011 00
C403A	Part of C403	CAPACITOR: Section of C403	
C403B	Part of C403	CAPACITOR: Section of C403	
C404	Antenna network	CAPACITOR: 50 mmf $\pm 10\%$ ; WV; 2500 V rms at 2 mc, 1000 v rms at 16 mc	913 4503 20
C405	Antenna loading	CAPACITOR: Single sect; 15-300 mmf	920 0014 00
C406,	Antenna loading	CAPACITOR: 220 mmf $\pm 10\%$ ; 2500 WV	
C407	Antenna Loading	CAPACITOR: 470 mmf 5%	
C408	Antenna loading	CAPACITOR: 220 mmf $\pm 10\%$ ; 2500 WV	
		KNOB: Tuning; black phenolic skirt w/indicator mark	281 0004 00
		KNOB: Tuning; black phenolic; skirt w/indicator mark	281 0007 00
		KNOB: Tuning; black phenolic	281 0018 00
E304, E305, E306, E307, E313	Wire tie point	TERMINAL: Ceramic bushing 13/32" diam x 5/16" thk w/solder lug 17/32" lg	190 1103 00
E308	Rear terminal strip	CONNECTOR: 14 term, barrier type strip w/lugs on back	367 0022 00
E309 E311 E312	Ground connector	POST, BINDING: Push type; 1/8" wire hole	372 1300 00
E314	Sidetone and muting	TERMINAL STRIP: Bakelite; 2 terminals	367 0010 00
E401	Parasitic suppressor	CHOKER: 3T #20 wire; wound on 100 ohm 2 watt resistor	503 3452 002
6-4			14214-4

## PARTS LIST

ITEM	CIRCUIT FUNCTION	DESCRIPTION	COLLINS PART NUMBER
F301	LV and filament	FUSE: 3 amp; 250 v	264 4080 00
F302	High voltage	FUSE: 5 amp; 250 v	264 4090 00
I302	Pilot lamp	BULB: Pilot light; 110 v, 55 ma; 6 w; candelabra base; T4-1/2 bulb	262 3330 00
I303, I304, I305, I306, I307, I308, I309, I310, I311, I312	Dial lamp	BULB: Pilot light; 6 v, .2amp; midget flange base; T1-3/4 bulb	262 0023 00
J101	Key	JACK: Phone single circuit, midget	360 0008 00
J102	Cable	CONNECTOR: Std octal socket	220 1850 00
J201	Microphone	CONNECTOR: 2 female contacts; wall mtg	365 1004 00
J202	Modulator	CONNECTOR: Std octal socket	220 1850 00
J203	Sidetone power	CONNECTOR: Std octal socket	220 1850 00
J301	Antenna Connector	CONNECTOR:	
K301	Carrier control	RELAY: Circuit control; contacts 1A1B1A and 2A; 48 v coil	970 1014 00
L101	Osc. plate choke	COIL: RF choke; 4 pi; duo-lat wound; 2.5 mh $\pm$ 20%; .125 amp	240 2100 00
L103	Buffer plate choke	COIL: RF choke; 500 uh $\pm$ 10%; 4 pi; universal wound	240 0042 00
L104	1st Mult. Tuning	COIL: LF; 38T #28 wire	503 2896 002
L105	2nd Mult. Tuning	COIL: MF; 17.3T #28 wire	503 2895 002
L106	2nd Mult. Plate choke	COIL: RF choke; 2 pi; duo-lat wound; 208 uh	240 6000 00
14215-5			6-5



## PARTS LIST

ITEM	CIRCUIT FUNCTION	DESCRIPTION	COLLINS PART NUMBER
L107	3rd Mult. tuning	COIL: HF 7.6T #28 wire	503 2835 001
L108	3rd Mult. tuning	COIL: LF; 38T #28 wire	503 2896 002
L109	PA grid choke	COIL: RF choke; 4 pi; duo-lat wound; 2.5 mh $\pm 20\%$ ; .125 amp	240 2100 00
L110	3rd mult. tuning	COIL: 23T #26 wire	503 4512 00
L111	1st Mult Plate Choke	COIL:	
L112	3rd Mult Plate Choke	COIL:	
L201	Sidetone input filter choke	COIL: RF choke; 500 uh $\pm 10\%$ ; 4 pi; universal wound	240 0042 00
L202	Sidetone output filter choke	COIL: RF choke; 500 uh $\pm 10\%$ ; 4 pi; universal wound	240 0042 00
L203	Sidetone audio input r-f choke	COIL: RF choke; 500 uh $\pm 10\%$ ; 4 pi universal wound	240 0042 00
L204	Audio r-f filter choke	COIL: RF choke; 500 uh $\pm 10\%$ ; 4 pi; universal wound	240 0042 00
L205		COIL: RF choke; 500 uh $\pm 10\%$ ; 4 pi; universal wound	240 0042 00
L206		COIL: RF choke; 500 uh $\pm 10\%$ ; 4 pi; universal wound	240 0042 00
L301, L302	LV filter	REACTOR, FILTER: 11 hy $\pm 15\%$	668 0012 00
L303	HV filter	REACTOR, FILTER: 5 hy $\pm 15\%$	668 0013 00
L401	PA plate tuning	COIL: LF tank; 20T #14 wire	503 2892 002
L402	PA plate tuning (28 mc)	COIL: HF tank; 5T silver pl copper tubing	503 2831 001
L403	PA plate choke	COIL: RF choke; 5 pi; duo-lat wound; 3.5 mh $\pm 10\%$	240 2700 00
L404	Network coil	COIL:	
M301	Mult. -purpose	METER: 0-5 ma DC; 50 scale div; marked 0-250, 0-500, 0-1000	458 0110 00
6-6			14216-3

## PARTS LIST

ITEM	CIRCUIT FUNCTION	DESCRIPTION	COLLINS PART NUMBER
M302	PA plate	METER: 0-500 mc DC; 50 scale div.	450 1500 00
P101	osc. power	CONNECTOR: 4 prong plug; part of oscillator filter assem	503 2868 002
P201	Microphone	CONNECTOR: 2 prong plug	369 1005 00
P301	Modulator power	CONNECTOR: Std 8 term octal plug	369 1009 00
P302	RF circuits power	CONNECTOR: Std 8 term octal plug	369 1009 00
P303	Sidetone power	CONNECTOR: Std 8 term octal plug	369 1009 00
R101		Not used	
R102	Buffer grid	RESISTOR: 22,000 ohm $\pm 10\%$ ; 1/2 w	745 1142 00
R103	Buffer cathode	RESISTOR: 560 ohm $\pm 10\%$ ; 1/2 w	745 1076 00
R104	Buffer screen	RESISTOR: .33 megohm $\pm 10\%$ ; 1/2 w	745 1191 00
R105	V101, V102, V103 grid	RESISTOR: .10 megohm $\pm 10\%$ ; 1/2 w	745 1170 00
R106	1st mult. grid	RESISTOR: .10 megohm $\pm 10\%$ ; 1/2 w	745 1170 00
R107	1st mult. cathode	RESISTOR: 820 ohm $\pm 10\%$ ; 1/2 w	745 1083 00
R108	1st mult. screen	RESISTOR: 22,000 $\pm 10\%$ ; 1/2 w	745 1142 00
R109	1st mult. plate decoupling	RESISTOR: 1000 ohm $\pm 10\%$ ; 1 w	745 3086 00
R110	2nd mult. grid	RESISTOR: .10 megohm $\pm 10\%$ ; 1/2 w	745 1170 00
R111	2nd mult. screen	RESISTOR: 10,000 ohm $\pm 10\%$ ; 1/2 w	
R112	2nd mult. plate decoupling	RESISTOR: 1000 ohm, $\pm 10\%$ ; 1 w	745 3086 00
R113	3rd mult. grid	RESISTOR: .10 megohm $\pm 10\%$ ; 1/2 w	745 1170 00
R114	3rd mult. screen	RESISTOR: 10,000 ohm $\pm 10\%$ ; 1/2 w	745 1142 00
R115, R116	3rd mult. plate decoupling	RESISTOR: 470 ohm $\pm 10\%$ ; 1 w	745 3072 00
R117	3rd mult. grid stabilizer	RESISTOR: 10 ohm $\pm 10\%$ ; 1/2 w	745 1002 00
14217-5			6-7

## PARTS LIST

ITEM	CIRCUIT FUNCTION	DESCRIPTION	COLLINS PART NUMBER
R118	2nd mult. cathode	RESISTOR: 1500 ohm $\pm 10\%$ ; 1/2 w	745 1093 00
R119	PA grid meter shunt	RESISTOR: 6.2 ohm $\pm 5\%$ ; 1/2 w	707 0104 00
R120	PA grid	RESISTOR: 3300 ohm $\pm 10\%$ ; 1 w	745 3107 00
R121	3rd mult. grid voltage divider	RESISTOR: .22 megohm $\pm 10\%$ ; 1/2 w	745 1184 00
R122	3rd mult. grid return	RESISTOR: 680 ohm $\pm 10\%$ ; 2 w	
R123	PA screen stabilizer	RESISTOR: 47 ohm $\pm 10\%$ ; 1 w	745 3030 00
R125	Dial light dropping	RESISTOR: 2 ohm $\pm 10\%$ ; 2 w	710 1070 00
R201	Audio input r-f filter	RESISTOR: 4700 ohm $\pm 10\%$ ; 1/2 w	745 1114 00
R202	V201 grid	RESISTOR: 1.0 megohm $\pm 10\%$ ; 1/2 w	745 1212 00
R203		RESISTOR: Not used.	
R204	V201 cathode	RESISTOR: 4700 ohm $\pm 10\%$ ; 1/2 w	745 1114 00
R205	Audio gain control	RESISTOR: .5 megohm $\pm 20\%$ ; 1/2 w	376 3027 00
R206, R207	V201 plate	RESISTOR: .47 megohm $\pm 10\%$ ; 1/2 w	745 1198 00
R208, R209	V201 plate decoupling	RESISTOR: 47,000 ohm $\pm 10\%$ ; 1/2 w	745 1156 00
R210	V202 grid	RESISTOR: .47 megohm $\pm 10\%$ ; 1/2 w	745 1198 00
R211	V202 cathode	RESISTOR: 560 ohm $\pm 10\%$ ; 1/2 w	745 1076 00
R212	Sidetone plate	RESISTOR: 22,000 ohm $\pm 10\%$ ; 1/2 w	745 1142 00
R213	Sidetone plate	RESISTOR: 22,000 ohm $\pm 10\%$ ; 1/2 w	745 1142 00
R214	Sidetone grid	RESISTOR: 4700 ohm $\pm 10\%$ ; 1/2 w	745 1114 00
R215	Sidetone grid	RESISTOR: 10,000 ohm $\pm 10\%$ ; 1/2 w	745 1128 00
R216	Audio decoupling	RESISTOR: 2200 ohm $\pm 10\%$ ; 1 w	745 3100 00
R217	Sidetone pitch control	RESISTOR: .5 megohm $\pm 20\%$ ; 1/2 w	376 3027 00
R301	V105 screen dropping	RESISTOR: 12,000 ohm $\pm 5\%$ ; 25 w	710 0366 00
6-8			14218-3

PARTS LIST

ITEM	CIRCUIT FUNCTION	DESCRIPTION	COLLINS PART NUMBER
R302		RESISTOR: Not used	
R303	Load stabilizing	RESISTOR: 7500 ohm $\pm 10\%$ ; 25 w size	710 0069 00
R304	V105 screen bleeder	RESISTOR: 25,000 ohm $\pm 10\%$ ; 25 w size	710 3254 20
R305	Mod. bias control	RESISTOR: 1000 ohm pot	377 0007 00
R306	Bias bleeder	RESISTOR: 750 ohm $\pm 5\%$ ; 10 w	710 1750 10
R307	LV bleeder	RESISTOR: 0.10 megohm $\pm 5\%$ ; 2 w	745 5169 00
R308	LV meter shunt	RESISTOR: 25 ohm $\pm 5\%$ ; 1/2 w	701 0001 00
R309	Relay voltage divider	RESISTOR: 5000 ohm $\pm 10\%$ ; 10 w	710 1542 00
R310	Relay voltage divider	RESISTOR: 7500 ohm $\pm 10\%$ ; 10 w	710 0033 00
R311	LV bleeder	RESISTOR: 0.10 megohm $\pm 5\%$ ; 2 w	745 5169 00
R312	HV meter shunt	RESISTOR: 25 ohm $\pm 5\%$ ; 1/2 w	701 0001 00
R313, R314	HV bleeder	RESISTOR: 0.10 megohm $\pm 5\%$ ; 2 w	745 5169 00
R315	Mod. shunt meter	RESISTOR: Wire wound; .51 ohm $\pm 5\%$ ; 1/2 w	707 0026 00
R316, R317	HV bleeder	RESISTOR: 0.10 megohm $\pm 5\%$ ; 2 w	745 5169 00
R318 R319	Mod. ind. shunt	RESISTOR: 25 ohm $\pm 5\%$ ; 1/2 w RESISTOR: 2000 ohm $\pm 10\%$ ; 10 w	701 0001 00 710 1242 00
R320	Series Tuning	RESISTOR: 15 ohms	
R321	Series Tuning	RESISTOR: 15 ohms	
S101	Band change switch	SWITCH: 8 pole, 5 pos, 4 sect; non-shorting	503 2923 004
S101A		SWITCH: Part of S101	
S101B		SWITCH: Part of S101	
S101C		SWITCH: Part of S101	
S101D		SWITCH: Part of S101	
S101E		SWITCH: Part of S101	
14219-4			6-9

## PARTS LIST

ITEM	CIRCUIT FUNCTION	DESCRIPTION	COLLINS PART NUMBER
S101F S101G S101H		SWITCH: Part of S101 SWITCH: Part of S101 SWITCH: Part of S101	
S301	Cabinet lid interlock	SWITCH: SP normally open snap switch	260 0010 00
S302	Emission selector	SWITCH: Band change; 8 pole; 3 pos, 3 sect; non-shorting	259 0264 00
S302A S302B S302C S302D S302E S302F S302G S302H		SWITCH: Part of S302 SWITCH: Part of S302 SWITCH: Part of S302 SWITCH: Part of S302 SWITCH: Part of S302	
S303	High voltage switch	SWITCH: SPST toggle; 25 amp	266 1040 00
S304	Low voltage switch	SWITCH: SPST toggle; 25 amp	266 1040 00
S305	600-700 v selector	SWITCH: DPDT toggle; 1 amp 250 v, 3 amp 125 v	266 0002 00
S306	Meter selector	SWITCH: Band change; 2 pole, 5 pos, 1 sect; non-shorting	259 0045 00
S306A S306B		SWITCH: Part of S306	
S401	PA plate circuit	SWITCH: Band change; 2 pole, 5 pos, 1 sect; shorting	259 0043 00
S401A		SWITCH: Part of S401	
S401B		SWITCH: Part of S401	
S402	Antenna loading	SWITCH: Band change;	
T201	Modulator input	TRANSFORMER: Driver; pri: 12,000 ohm, sec: 5300 ohm CT, freq resp 300-3500 cps $\pm 3$ db	667 0011 00
T202	Modulation	TRANSFORMER: Mod; pri: 7000 ohm CT, 100 ma DC max, bal; sec: 500/3750 ohm, 200 ma DC, unbal; freq. resp 300-3500 cps $\pm 3$ db; 60 w	667 0010 00
6-10			14220-3

## PARTS LIST

ITEM	CIRCUIT FUNCTION	DESCRIPTION	COLLINS PART NUMBER
T301	Low voltage	TRANSFORMER: Power; pri: 115 v, sec #1: 850 v CT; sec #2: 5 v, 4 amp; sec #3: 5 v, 4 amp; sec #4: 6.3 v, 9 amp 50/60 cps	662 0009 00
T302	High voltage	TRANSFORMER: Power; 50/60 cps; pri: 115 v; sec: 1100 v CT, w/pri leads #1 and #2 on 115 v, sec leads #4 and #6 should be 1370 v rms	662 0014 00
V101	Buffer amp.	TUBE: Type 6AK6; power amp pentode; miniature	254 0632 00
V102	1st multiplier	TUBE: Type 6AG7; video power amp pentode	254 0120 00
V103	2nd multiplier	TUBE: Type 7C5; beam power amp; octalox	254 0217 00
V104	3rd Multiplier	TUBE: Type 7C5; beam power amp; octalox	254 0217 00
V105	Power amplifier	TUBE: Type RK-4D32; tetrode	256 0078 00
V201	1st and 2nd audio	TUBE: Type 6SL7GT; twin-triode amp	254 0187 00
V202	Audio driver	TUBE: Type 6SN7GT; twin-triode amp	254 0188 00
V203	Modulator	TUBE: Type 807; transmitting beam power amp	254 0391 00
V204	Modulator	TUBE: Type 807; transmitting beam power amp	254 0391 00
V205	Sidetone oscillator	TUBE: Type 6SL7GT; twin-triode amp	254 0187 00
V301	Low voltage rectifier	TUBE: Type 5Z4; full wave hi-vac rect	254 0110 00
V302, V303	High voltage rectifier	TUBE: Type 5R4GY; full-wave hi-vac rect	254 0099 00
V304	Bias voltage regulator	TUBE: Type OA3/VR-75; voltage regulator	257 0008 00
V305 V306	Screen voltage limiter	TUBE: Type OA2; voltage limiter	257 0052 00
X101	Socket for V101	SOCKET, TUBE: Miniature shielded	220 1003 00
	Shield for V101	SHIELD, TUBE: Miniature tall	141 0002 00
14224-2			6-11

## PARTS LIST

ITEM	CIRCUIT FUNCTION	DESCRIPTION	COLLINS PART NUMBER
X102, X205	Socket for V102, V205	SOCKET, TUBE: Octal, bakelite	220 1850 00
X103, X104	Socket for V103, V104	SOCKET, TUBE: Loktal, bakelite	220 1002 00
X105	Socket for V105	SOCKET, TUBE: 7 prong ceramic w/clips	220 1014 00
X201, X202	Socket for V201, V202	SOCKET, TUBE: Octal; bakelite	220 1850 00
X203,	Socket for V203, V204	SOCKET, TUBE: 5 prong ceramic w/clips	220 5520 00
X301	Socket for V301	SOCKET, TUBE: Octal, bakelite	220 1850 00
X302, X303	Socket for V302, V303	SOCKET, TUBE: Octal ceramic w/clips and keyway	220 5810 00
X304	Socket for V304	SOCKET, TUBE: Octal bakelite	220 1850 00
X305, X306	Socket for V305, V306	SOCKET, TUBE: Miniature, 7 term	220 1003 00
X307 X308	Holder for F301 Holder for F302	HOLDER, FUSE: Extractor post for 1/4" x 1-1/4" fuses	220 1002 00
X309, X310	Mtg for I301 Mtg for I302	MTG, PILOT LIGHT: Bracket for candelabra base bulb	262 1320 00
	Jewel for I301	JEWEL: Pilot light, green faceted	262 2130 00
	Jewel for I302	JEWEL: Pilot light; red faceted	262 2110 00

The 70E-8A oscillator used in this equipment has been dehydrated and hermetically sealed. If servicing is required it should be returned to the Collins Radio Company.

T V I R E D U C T I O N

for

A M A T E U R T R A N S M I T T E R S





## LIST OF ILLUSTRATIONS

- Figure 1 35C-1 Low Pass Filter Attenuation Curves
- Figure 2 35C-1 Low Pass Filter Schematic
- Figure 3 35C-1 Low Pass Filter Photograph - Open
- Figure 4 Balun and Tapered Line Characteristics
- Figure 5 Construction of the Balun and Tapered Line

## TELEVISION INTERFERENCE

### 1.1. GENERAL.

This booklet has been written to assist in the understanding of the television interference problem and to present certain methods by which television interference may be eliminated.

The problem of interference with reception of television signals has become more important with the wide-spread installation of television receivers. These receivers are often used in secondary service areas where the television signal is extremely weak and a satisfactory picture is impossible with the presence of a very low-level interfering signal. As is the case with broadcast receiver interference by the radio amateur, the difficulty lies in many cases in the design of the receiving apparatus in the form of inadequate selectivity, poor shielding, and insufficient pre-selection. Notwithstanding the deficiencies which are usually present in receivers, Collins engineers have expended a great deal of effort in trying to solve the problem of TVI.

It has been said that the interfering signal should be attenuated to the extent that not over 50 microvolts signal is present in the vicinity of a television receiver antenna located 100 feet away. The following methods of eliminating TVI are presented for consideration realizing that as few as one or as many as all the methods may be necessary to afford satisfactory protection:

- (a) Reduce spurious signals in the transmitter output.
- (b) Filtering of transmitter output at the antenna terminal.
- (c) Shielding of transmitter.
- (d) Filtering of television receiver antenna input.

#### 1.1.1. DISCUSSION OF TVI ELIMINATION METHODS. -

(a) and (b). The first step in the program to reduce television interference from the Model 32V was to redesign so as to reduce the spurious signals in its output. In the 32V-2 series traps are used in the exciter portions of the transmitter and an L section was added to the output network to reduce the unwanted signals to a degree which will remedy some phases of television interference. The L section in the final amplifier is particularly well adapted to the reduction of harmonic output from the transmitter. Where the receiver is located very close to the transmitting antenna, it may be necessary to add an effective low-pass filter in series with the transmitter output line. Since it is difficult to build an effective filter at high impedance, 50 ohms was selected as a convenient value because the standard 50 ohm solid dielectric coaxial cable, RG-8/U is readily available.

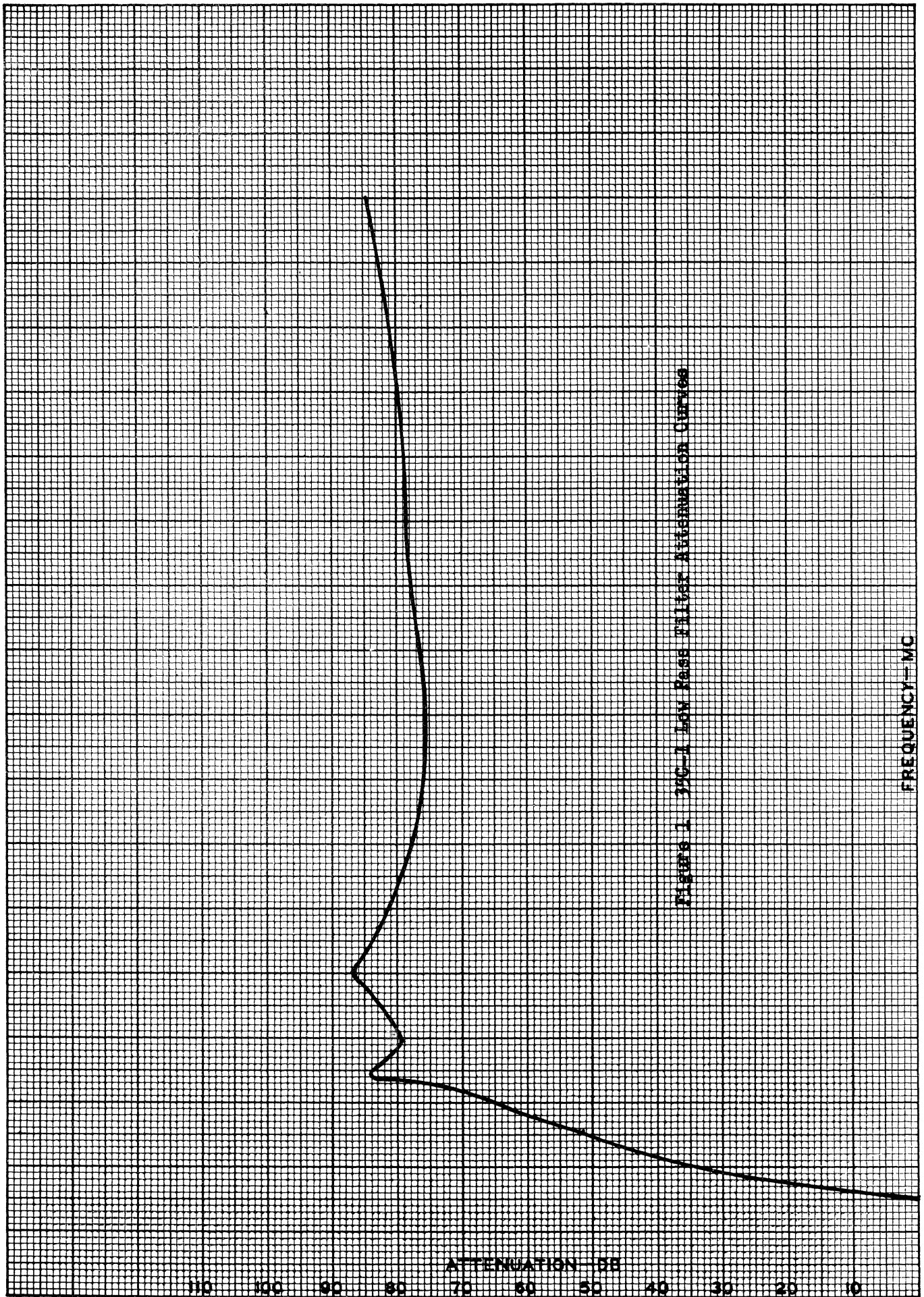

FIGURE 1. 3MC-1 LOW PASS FILTER ATTENUATION CURVES

The idea of tearing into an otherwise perfectly functioning transmitter and changing the class of operation or adding filter components is not very well accepted by most amateurs. The reasonable alternative is a well shielded, compact and highly effective external filter unit to be placed in the antenna transmission line. To make the shielding of the filter unit most effective and at the same time reduce the possibilities of complications, unbalanced output of the transmitter can be used with the result that inexpensive coaxial line can be used to connect the transmitter to the filter unit. The outer conductor of the line and the case of the filter unit can then be easily grounded. The filter can be constructed to give 70 db attenuation to all frequencies above 5½ mc. See figure 1. The Collins Model 35C-1 Low Pass Filter can be connected directly to the output connector of a Collins Model 32V-2 or to the 32V-1 by replacing the antenna post with a coaxial fitting.

(c) Shielding of the transmitter can be resorted to if it is determined that direct harmonic radiation is taking place from a source other than the antenna. An integral part of any shielded transmitter should be suitable circuits filtering each wire emanating from the transmitter cabinet. Such a cabinet would be inherently air tight so in the larger transmitters, a means of forced air ventilation would likely be necessary. A completely shielded and well filtered cabinet is available for the 32V-series transmitters. This cabinet does not include the 35C-1 Low Pass Filter since it must be external to the cabinet to avoid coupling and the purchaser of a cabinet will likely have a 35C-1 filter already in service.

(d) Filtering the television receiver antenna input can be effective if it is determined that the television receiver design is susceptible to low frequency (5½ mc and lower) transmitter outputs. A suitable high pass filter can be purchased or constructed from plans presented in the principal amateur publications.

1.2. DESCRIPTION AND APPLICATION OF THE 35C-1 LOW PASS FILTER.

The Collins Model 35C-1 Low Pass Filter is designed for television interference elimination where the interference is of harmonic origin. Refer to figure 2 and figure 3.

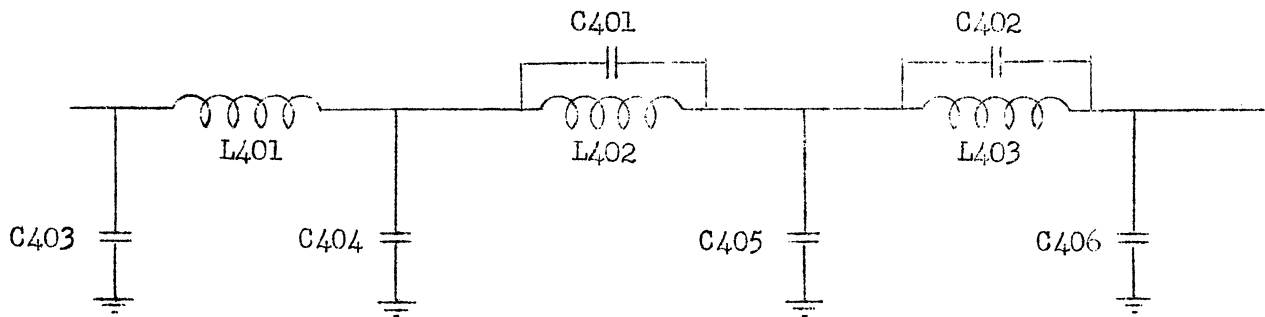

Figure 2 35C-1 Filter Schematic

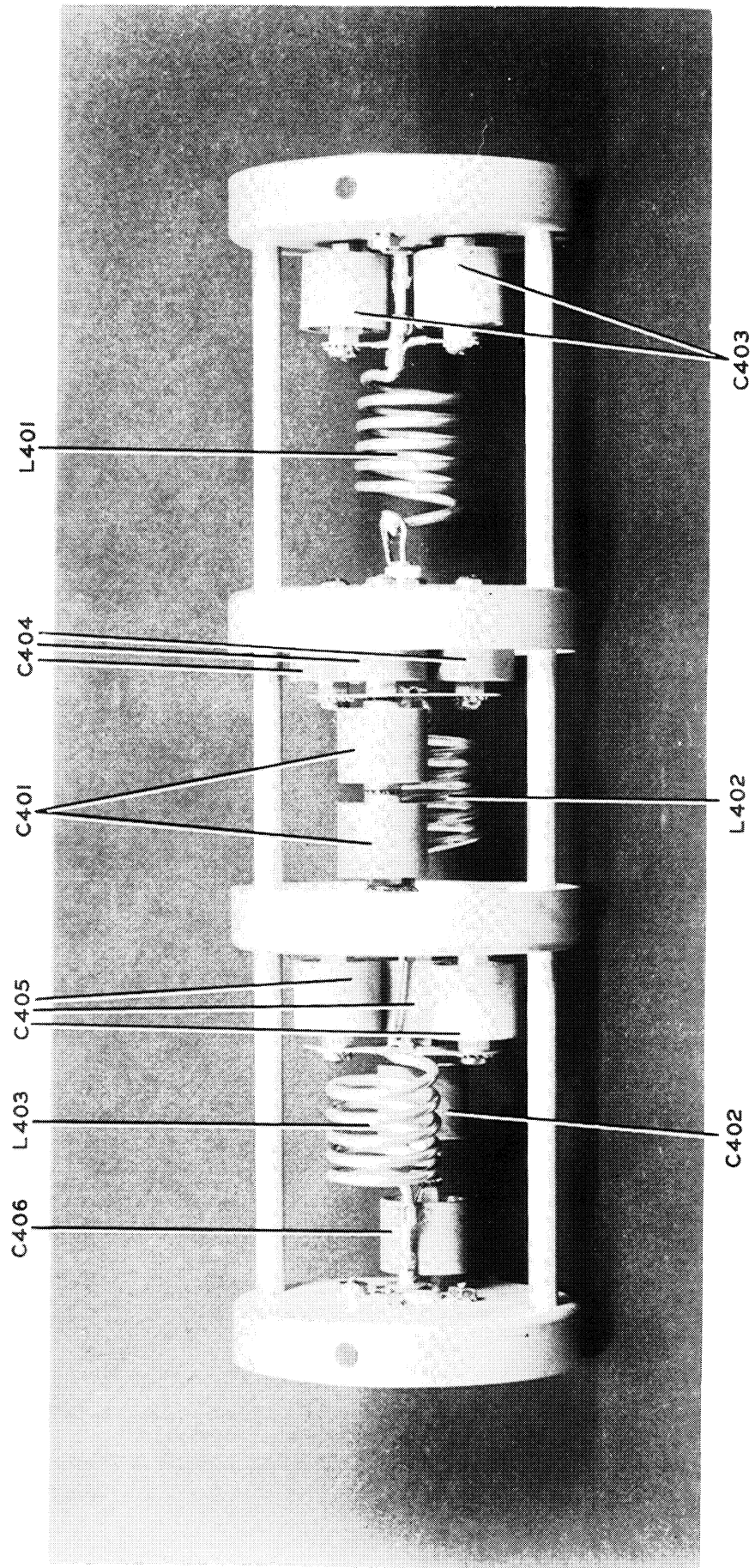

FIGURE 3. 35C-1 LOW PASS FILTER — INSIDE

Adequate shielding is assured by constructing the filter in a metal tube 3-1/8" in diameter and 10-3/8" long and by the use of coaxial input and output fittings. The unit is provided with a pair of studs for convenient mounting in the ventilation slots on the rear of a model 32V transmitter. A short section of RG-8/U coaxial cable is furnished to connect the filter to the transmitter. The input and output impedances are 52 ohms. The output of the filter should be connected to an antenna tuner or to a transmission line having an impedance of 52 ohms appearing at its termination. The filter must never be used without proper termination on the output end since high voltages likely to be developed may possibly damage it. The filter is not as effective if it is mismatched. The filter has very low insertion loss and can be expected to attenuate all outputs higher than 54 mc at least 70 db. It is tentatively rated at 500 watts (properly terminated).

## 2.1. THE BALUN AND IMPEDANCE MATCHING LINE.

2.1.1. GENERAL. - Since the foregoing discussion on TVI suggests the use of an unbalanced transmitter output, a means of coupling to a balanced antenna from the filter output is in order. The usual way is to construct an antenna tuner and place it in the radiating system. A description, complete with photographs and schematics, of a suitable antenna tuner is given in the 32V instruction book. The coils shown are available at the Collins Radio Company and the other components are readily available at any radio supply house. An antenna tuner is sometimes difficult to adjust for proper loading and low loss. The system to be described here is a wide band, low loss, simple to operate system which will couple an unbalanced source to a balanced load and at the same time provide a means of matching the impedance of the source to that of the load. The load chosen here is 300 ohms because of the present popularity of the high grade transmission line commercially available at that impedance value. This system actually consists of two sections, the balun and the impedance matching tapered transmission line. Actually the balun is constructed to realize a small amount of impedance matching in itself (52 to 100 ohms). Characteristics of the balun and impedance matching line are such that over a four to one frequency range a standing wave ratio of less than 2-1 is possible, providing the system is terminated in 300 ohms resistive. The efficiency of the system is very good even beyond the specified frequency limits.

Refer to figure 4 for a chart showing the resistance and reactance characteristics of the system to be described.

2.1.2. THE BALUN. - The balun is the familiar "Bazooka" described in the antenna handbooks, with slight modifications. The balun will operate over a frequency range of 4-1 satisfactorily, therefore a frequency of 18.5 mc is chosen to construct the balun around since the 4-1 frequency ratio will allow operation from 7.0 to 30.0 mc using this frequency. See figure 5. The first four feet of the upper half of the balun (section a.) is just an extension of the 52 ohm line from the transmitter. The next eight feet (section b.) is made from RG-11/U coaxial line which has the effect of raising the impedance through the balun from 50 to 100 ohms. Section a. and Section b. are



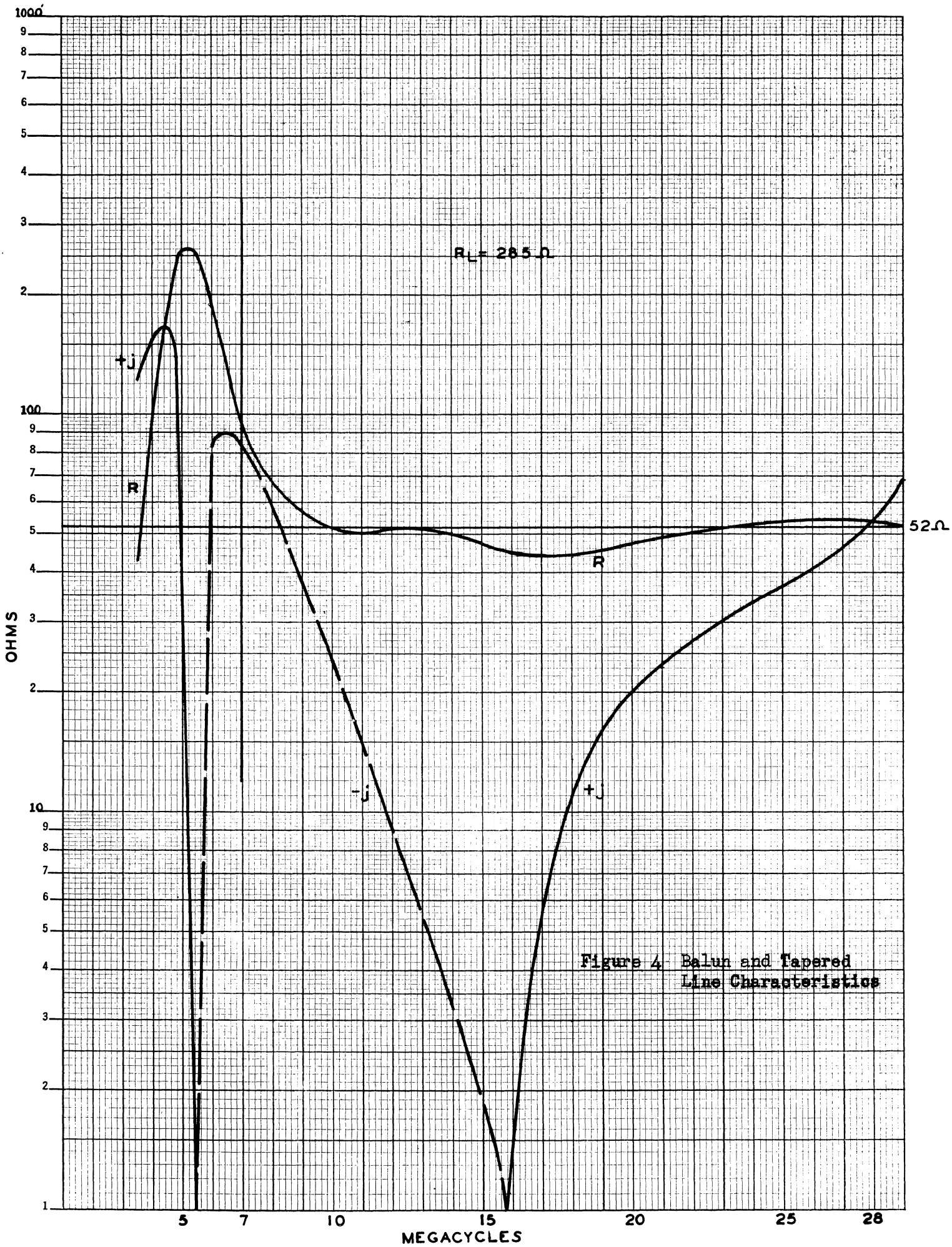

Figure 4. Balun and Tapered Line Characteristics



connected together with an 83-LJ coupling. The outer conductor of the RG-11/U section connects to one of the 1" aluminum tubes, which comprise section d., by means of a special adapter. The center conductor of the RG-11/U section connects to the other 1" aluminum tube by means of an insulated wire protruding from the side of the adapter. A section of RG-8/U 12 feet long is used for the detuning section of the balun (section c.). The shield of this section is soldered to the shield of the balun input line four feet from where the RG-11/U cable connects. The center conductor is not used. At the other end, the detuning section connects to the second 1" aluminum tube by means of coaxial fittings and the special adapter. The two elements of the balun are separated with .65" spacers.

2.1.3. THE TAPERED LINE. - The purpose of the tapered line is to transform the 100 ohm impedance of the output of the balun to 300 ohms. This could be done in a single quarter wave section but much broader frequency characteristics can be obtained by using several quarter wave sections of smaller impedance jumps in series. As in the case of the balun, the length for each quarter wave section is calculated using a frequency that is the arithmetical mean of the lowest and highest frequency chosen, in this case  $\frac{7 + 30}{2} = 18.5$  mc

which results in lengths of about 12 feet for our quarter wave sections. The characteristic impedance of the first section following the balun is calculated at 171 ohms, which is obtained by the use of two 1" aluminum tubes spaced 11/16" apart. The impedance of the first section can be transformed to 300 ohms by a quarter wave line constructed of 12 feet of 1/2" tubing spaced 1.15" apart. The spacings mentioned are from the outside surfaces of the tubes and not from the center lines. Any type of 300 ohm resistive load can be attached to the end of the 1/4" line. The October, 1947 "Proceedings" of the IRE page 1153 contains information on this system which may be of interest.

2.1.4. ASSEMBLING THE BALUN AND TAPERED LINE. - Collins Radio Company is manufacturing a kit of parts from which a balun and tapered line can be constructed. This kit can be easily assembled using the ordinary tools found in the tool box. Assembling the system consists of attaching the adapters onto the end of the 1" aluminum pipe, placing and fastening the various spreaders, and connecting the sections of the system together. The adapters are inserted into the end of the 1" pipes (one in each pipe) and fastened with the 1/2" 8-32 screws provided. Each section of transmission line should be equipped with spreaders equally spaced within the section. After the various sections have been assembled, they can be attached together using the screws and connectors furnished. See figure 5. When using the system, connect the balun, with its attached 20 feet of RG-8/U, directly to the transmitter or to the output of a 35C-1 Low Pass Filter. Any bends in the system should be gradual and the spacings between the two conductors must be maintained.

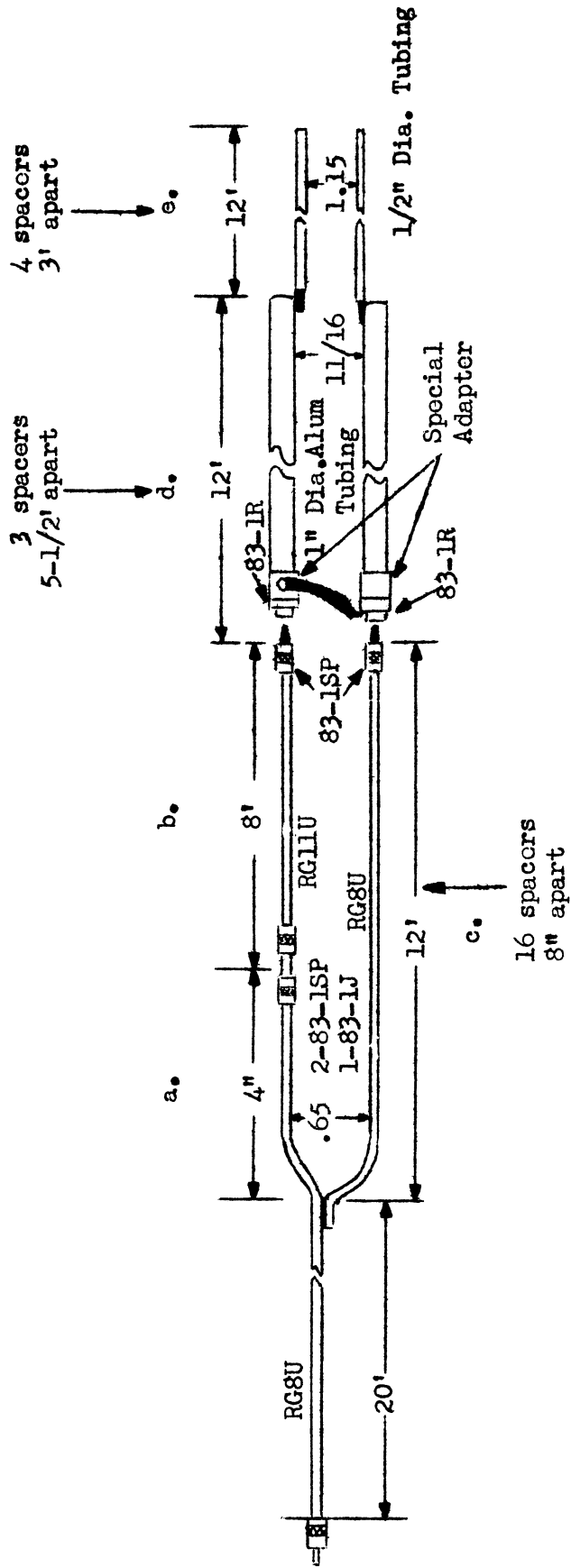
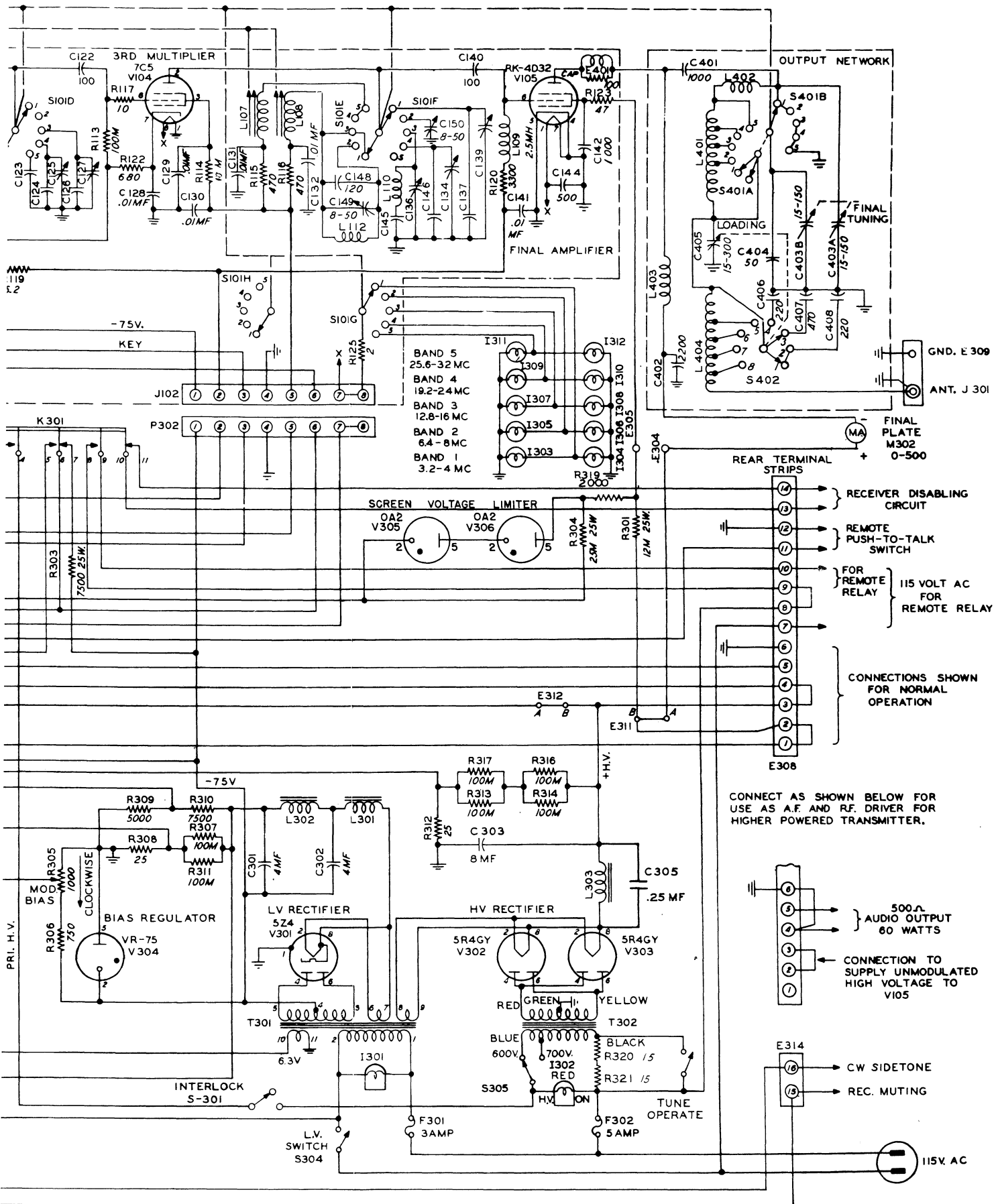

Figure 5 Balun and Tapered Line Schematic

## 315E-1 BALUN TRANSFORMER

DESCRIPTION	PART NAME	PART NUMBER	QUANTITY
7 to 30 mc Balun	315E-1 Kit	520 4704 00	1
Balun	Cable Assembly	504 4520 002	1
No. 3	Cable Assembly	504 4526 002	1
Support	Plate	504 4525 002	1
Left	Bracket	504 4522 002	1
Right	Bracket	504 4523 002	1
1 inch	Tubing	504 4527 002	2
1/4 inch	Tubing	504 4521 002	2
No. 1 cable	Spacer	504 4517 001	17
No. 2	Spacer	504 4518 001	2
No. 3	Spacer	504 4519 001	8
Receptacle, single female contact	Connector	357 9005 00	2
Solder	Lug	304 0017 00	1
8-32 x 1-3/4	Screw	343 0319 00	8
8-32 hex	Nut	313 0054 00	16
No. 8 flat	Washer	313 0058 00	8
No. 14 bus	Wire	421 1420 00	0.2 ft
6-32 x 1-1/8 PBH	Screw	343 0337 00	17
6-32 hex	Nut	313 0053 00	34
Double ended female adapter	Connector	357 9062 00	1
4-40 x 1/4 PBH	Screw	343 0133 00	2
No. 4 shakeproof	Washer	373 8010 00	2
4-40 hex	Nut	313 0043 00	2
4-40 x 5/16 PBH	Screw	343 0286 00	8
No. 4 shakeproof	Washer	373 7010 00	8
4-40 hex	Nut	313 0051 00	8
No. 1	Cable Assembly	504 4528 003	1
No. 2	Cable Assembly	504 4524 002	1



ic Diagram

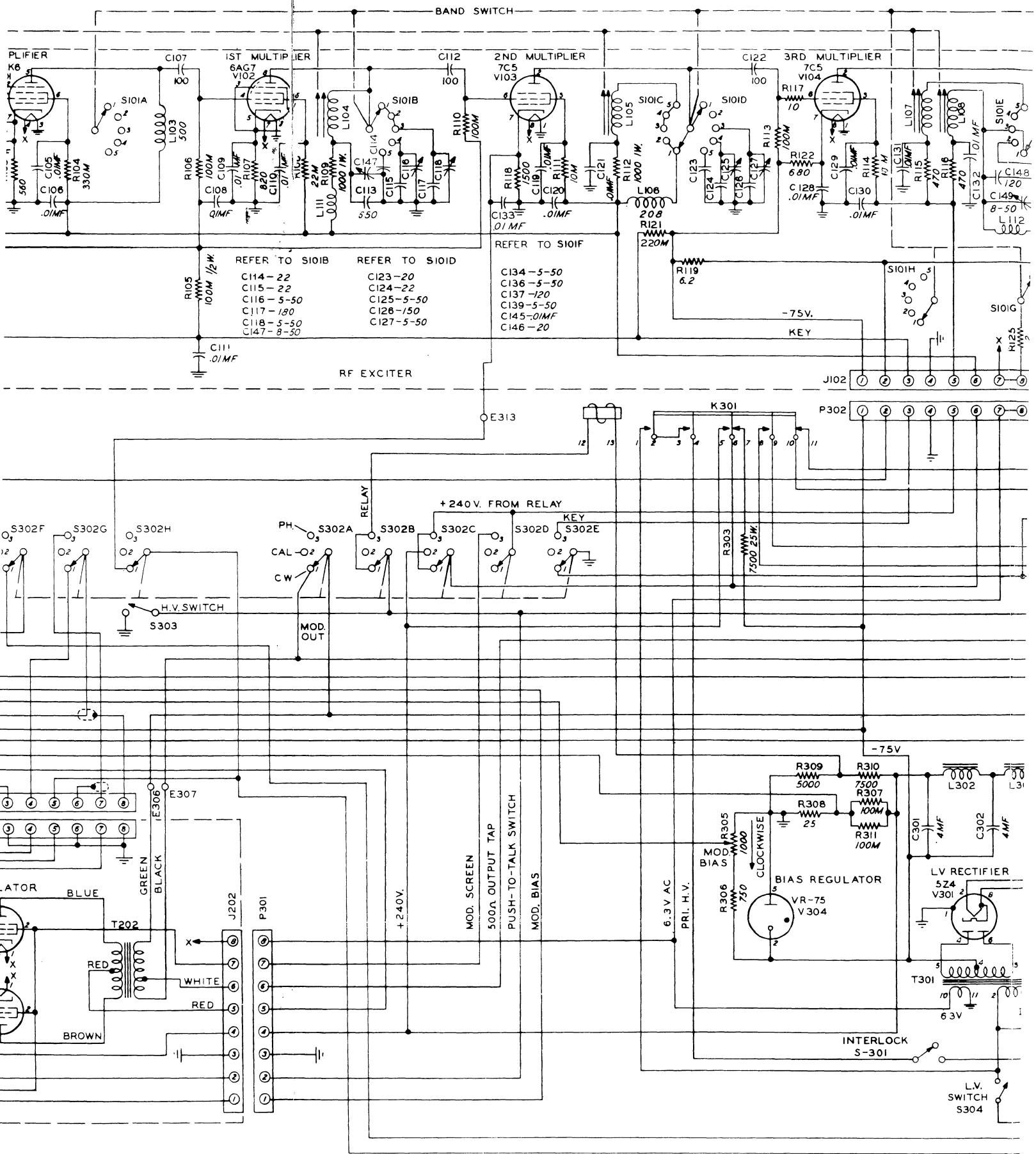

Figure 5-8 Model 32V-2 Complete Schematic Diagram

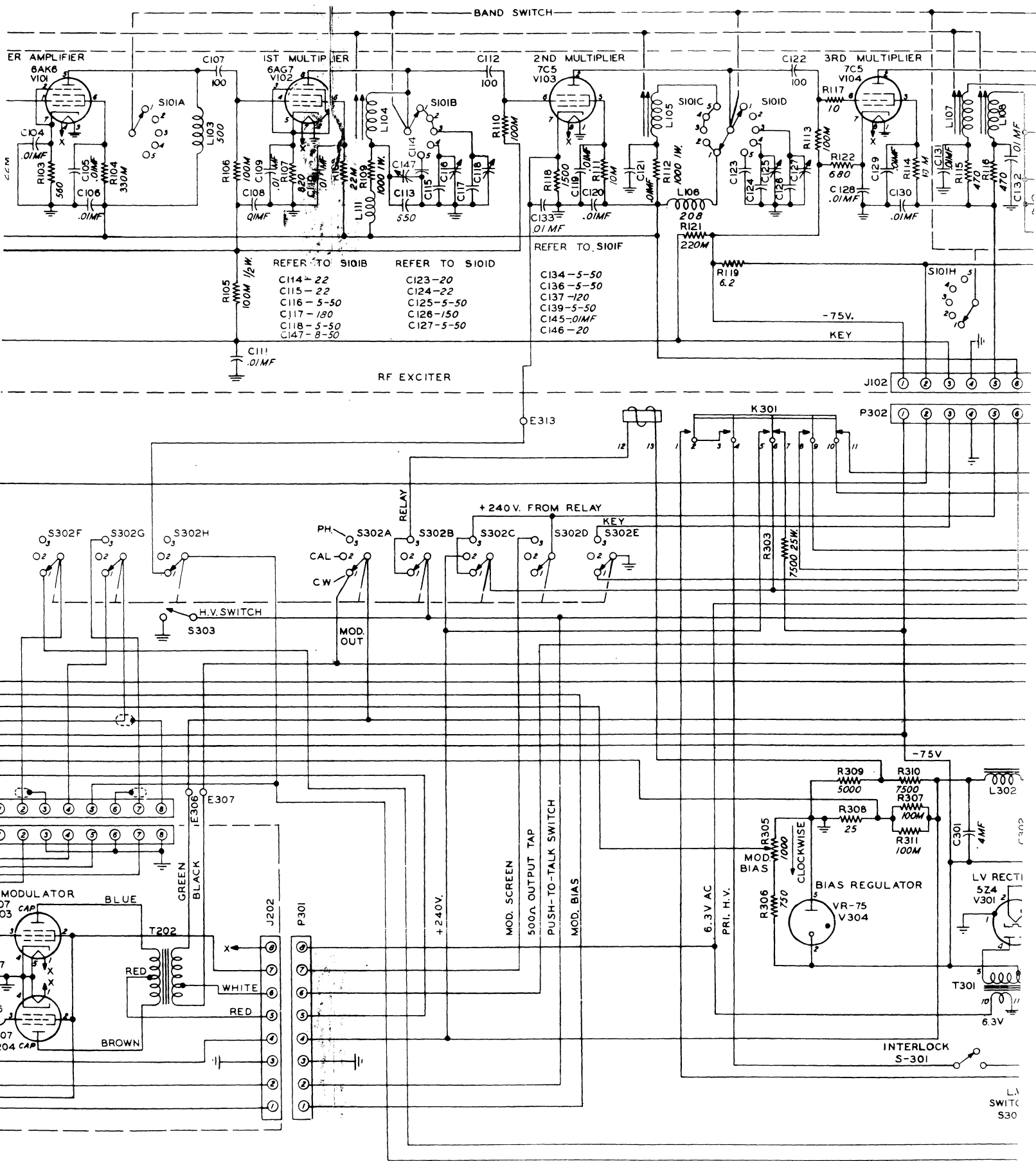
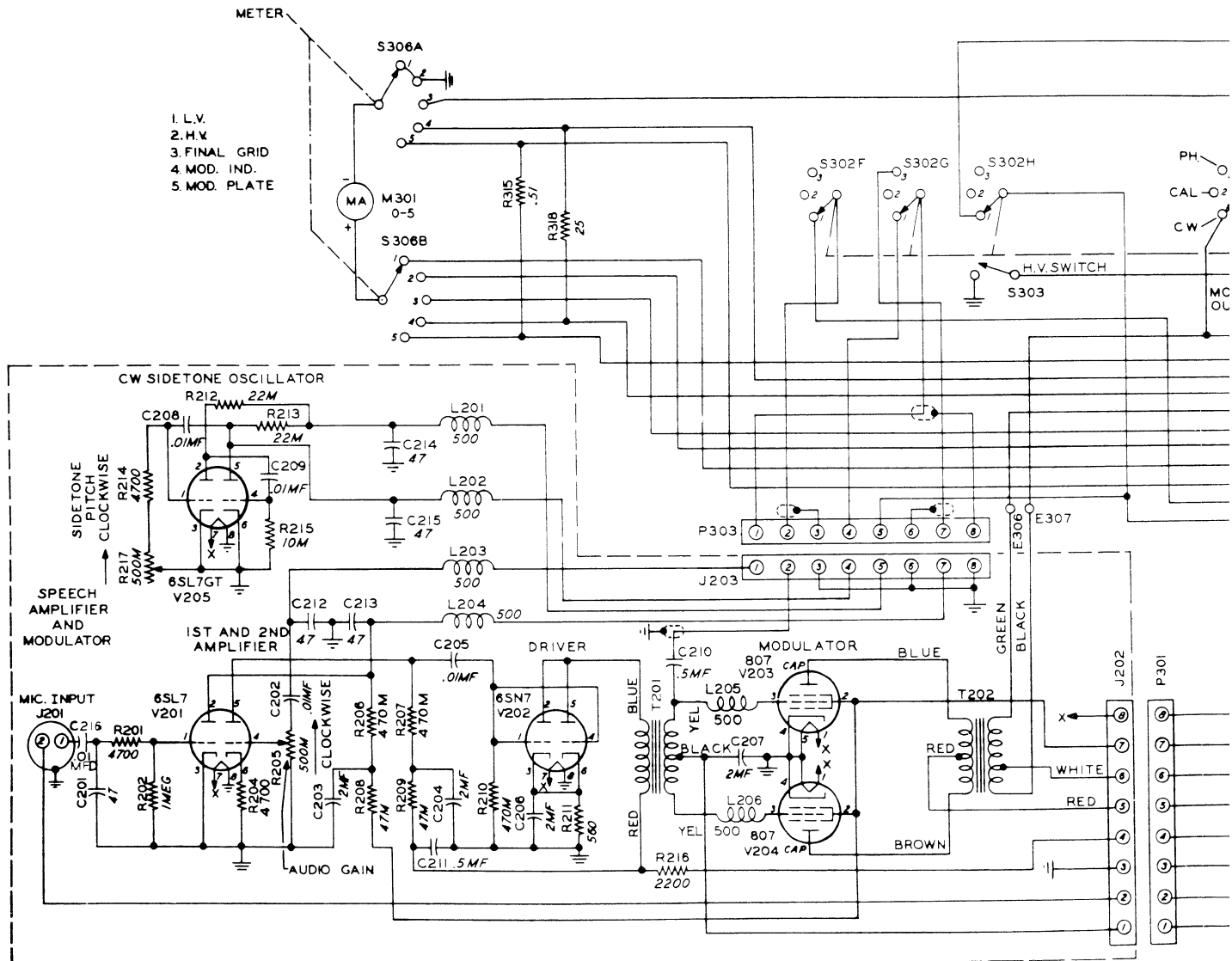
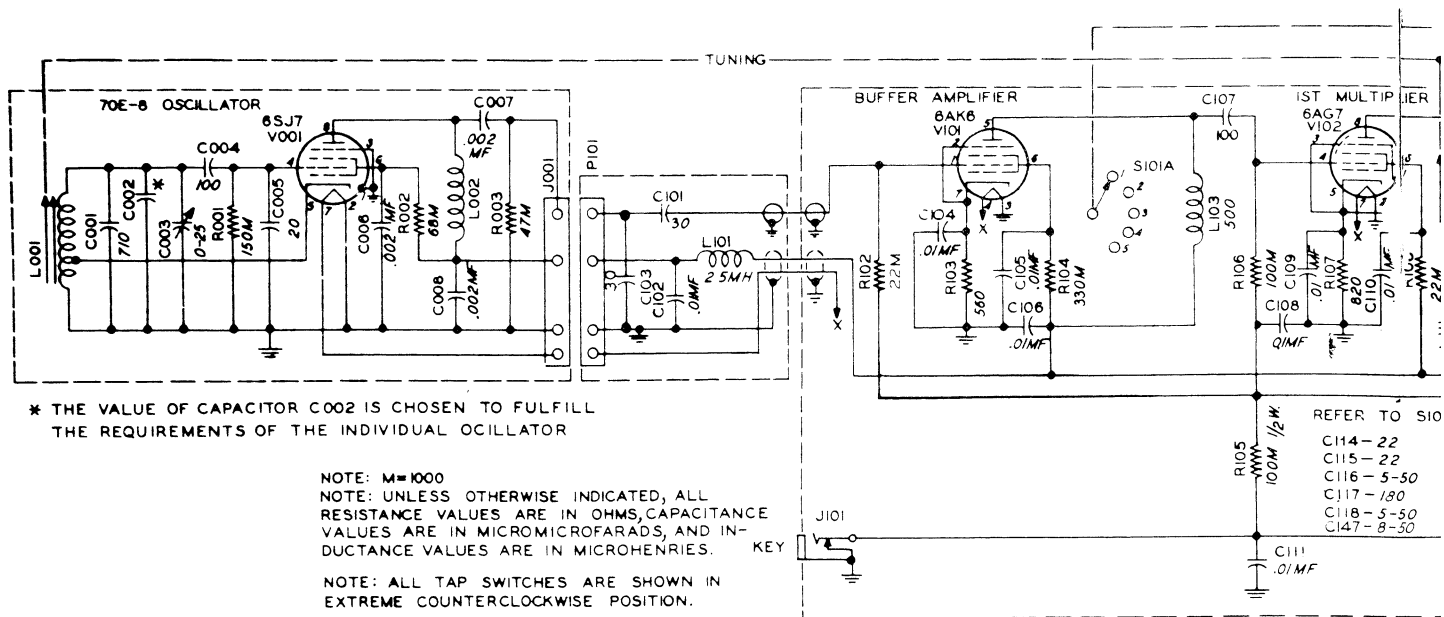
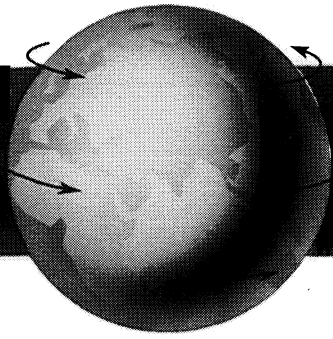

Figure 5-8 Model 32V-2 Complete Schematic Diagram



Figur



# SERVICE BULLETIN

EQUIPMENT TYPE: 32V-2

BULLETIN NO. 2

DATE: 6-1-50

Since the 148B-1 Narrow Band FM modulator was originally designed, there have been some changes made in the design of the 32V-2 Transmitter.

These changes have resulted in some instances in low grid drive when attempting to use the 148B-1 with these transmitters. Wherever this occurs, it can be easily corrected by removing condenser C601, which is the 24 mmfd. capacitor mounted between Pins 2 and 4 on J601 on the bottom cover of the 148B-1. A buss jumper should then be connected across C101, which is located in the filter can of the 32V-2 Transmitter.

These modifications should eliminate the difficulty of low grid drive and this condition will be corrected in all future units.





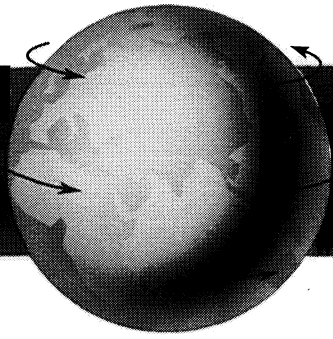

## SERVICE BULLETIN

EQUIPMENT TYPE 32V-2

BULLETIN NO. 1

DATE 2-17-56

Page 1 of 2

After recognizing the high order of filtering that it was necessary to incorporate in an amateur transmitter operating in close proximity to television receivers, Collins engineers designed an output network to be used in the 32V-2 which should offer a great deal of attenuation to high order harmonics. In order to do this, it was necessary that an additional "L" section filter be added to the existing pi section. This new section contributes a great deal of filter action, but also offers some disadvantages. The first apparent difficulty noted is the apparent sharpness of tuning on the high frequency bands, particularly 28 mc. It must be recognized that this is inherent in any tuned filter where a high degree of selectivity is needed, and the fact that it does tune so sharply indicates that it is operating properly. Since the impedance across the L section inductance reaches fairly high values so does the voltage, and in certain cases, the addition of modulation to the carrier causes the output capacitor to arc across. It has been found that this voltage can be decreased to a point where this no longer occurs by lowering the inductance of the 28 mc portion of the L section inductor. The decrease in filter action by such a move is slight.

This modification, which is included in the late 32V-2's, is fortunately a simple one and can be readily accomplished by the customer. The task is to change the uppermost tap on L404 so that the inductance will consist of 8 turns from the top end of the coil instead of 11. An examination of this inductance will readily show that it is a simple task to move the lead that goes to the 11th from the top to the 8th.

Another source of difficulty that is occasionally encountered is the failure of the fixed ceramic loading capacitors in the pi section network. Unfortunately, the solution of this problem is not so simple and requires an understanding by the customer of the variables involved.

The pi section network was designed so that when used with the L section, a suitable range of impedances could be satisfactorily matched. The extreme cases were tabulated and the resulting voltages and currents were calculated. These voltages and currents were of such a magnitude as to not exceed the ratings of the components. However, when the customer connects the 32V-2 to an antenna system, frequently the standing waves are of such a nature as to reflect sufficient reactance so that the assigned endpoints of impedances are exceeded. This frequently results in an excess current thru the loading capacitors and subsequent failure.

However, when adequate precautions are taken, this problem can be greatly reduced. These precautions may be described simply by stating that they are directed in such a manner as to insure a flat 52 or 72 ohm line from the 32V-2 to the antenna tuner. The tuning procedure is as follows:



Disconnect the coaxial line from the antenna tuner link and terminate it in a non-inductive resistor whose value is the same as the  $Z_0$  of the coaxial line, and whose power rating is sufficient to dissipate 50 watts or so for prolonged periods. The transmitter should then be tuned and loaded to the proper point in the "Tune" position. The unit should then be momentarily switched to the operate position to see that the final plate current reading is correct. In the event that non-inductive resistors are not available, it is possible to use a 100 watt lamp and obtain a SWR of about 1.5/1 on a 52 ohm line.

The coaxial line should then be connected through a series variable capacitor to the antenna tuner link of 2 or 3 turns. The antenna tuner is resonated with the transmitter and the link reactance tuned out with the coaxial line series capacitor. The feeders should then be moved in equal increments out from the center, with the tuned circuit resonated, until the same loading condition exists that was noted with the dummy load. This will set up the desired condition where the transformation of impedance from the coaxial line is from 52 or 72 ohms to the antenna impedance. If this is done, no standing waves will exist on the coaxial line and the loading capacitors will not be operated at excessively high values of current.