

INSTRUCTION MANUAL

EDDYSTONE

850/2

**COMMUNICATIONS
RECEIVER**

**STRATTON & CO. LTD.
EDDYSTONE WORKS
BIRMINGHAM 31**

EDDYSTONE COMMUNICATIONS RECEIVER

MODEL 850/2

INTRODUCTION

The EDDYSTONE Model 850/2 is a single conversion communications superhet receiver covering the low and medium frequencies in the band 10 kc/s to 600 kc/s. Provision is made for both AM and CW reception with separate detectors for each mode. The receiver operates directly from all standard AC mains supplies.

Three positions of IF selectivity are available, two of which employ crystal filters. The overall selectivity can be increased by bringing into circuit a highly selective ferrite filter which is used as a coupling element in the audio section of the receiver. Three independent gain controls are fitted, together with an efficient delayed AGC system. Other features include a built-in carrier level meter, noise limiter and provision for desensitising when the receiver is used with an associated transmitter.

Audio outputs are available for connection to an external loudspeaker, telephones and remote lines, the latter output being available at high or low level to suit various applications. A cathode follower provides a low impedance output at the Intermediate Frequency and the AGC line is brought out to a terminal at the rear for convenience in interconnecting receivers used in diversity installations.

Sub-chassis construction is employed with all units firmly fixed to a strong diecast aluminium panel. A well ventilated steel cabinet provides adequate protection against rough usage and the receiver can be supplied for either rack or table mounting. High quality components are employed throughout and the 850/2 is suitable for continuous operation in all areas under extreme climatic conditions.

LIST OF CONTENTS

<u>Section.</u>	<u>Page.</u>
Technical Data	2
Circuit Description	4
Constructional Details	6
Installation	8
Operation	10
Re-alignment	13
Appendix 'A' List of Voltage Values	17
Appendix 'B' List of Component Values, Tolerances and Ratings	18
Appendix 'C' Spares	22
Illustrations and Circuit Diagram at rear of Manual.	

THE COMPANY RESERVE THE RIGHT TO VARY THE INFORMATION CONTAINED IN THIS PUBLICATION.

Manufacturer:- STRATTON & CO. LTD., ALVECHURCH ROAD, BIRMINGHAM, 31.

TECHNICAL DATA

GENERAL

Frequency Coverage.

10 kc/s to 600 kc/s in six ranges as follows:-

Range 1.	300 - 600 kc/s.	Range 4.	40 - 85 kc/s.
Range 2.	150 - 310 kc/s.	Range 5.	19 - 40 kc/s.
Range 3.	80 - 160 kc/s.	Range 6.	10 - 20 kc/s.

Intermediate Frequency.

720 kc/s.

Valve Complement.

V1	..	6BA6 (CV454)	..	RF Amplifier.
V2	..	6AJ8 (CV2128)	..	Frequency Changer.
V3	..	6BA6 (CV454)	..	1st IF Amplifier.
V4	..	6BA6 (CV454)	..	2nd IF Amplifier.
V5	..	6AL5 (CV140)	..	Noise Limiter/Meter Protection.
V6	..	6AU6 (CV2524)	..	Cathode Follower (IF OUTPUT).
V7	..	6AT6 (CV452)	..	AM Det., AGC Rect., AF Amplifier.
V8	..	6AM5 (CV136)	..	Audio Output.
V9	..	6BE6 (CV453)	..	CW Detector.
V10	..	VR150/30 (CV216)	..	HT Stabiliser.
V11	..	5Z4G (CV1863)	..	HT Rectifier.

Input and Output Impedances.

Aerial Input	..	75 and 300 Ω (balanced and unbalanced).
IF Output	..	75 Ω (nominal) unbalanced. Suitable for terminating impedances in the range 75-300 Ω .
Audio Outputs	..	Loudspeaker : 2.5/3 Ω . Lines : 600 Ω (unbalanced). Telephones : Nominally 2000 Ω but suitable for a wide range of impedances.

Power Supply.

110V and 200/250V AC (40-60 c/s). Consumption : 80 volt-amperes.

PERFORMANCE

Sensitivity.

The CW sensitivity is better than 5 μ V for a 15dB signal-to-noise ratio at all frequencies throughout the tuning range.

The AM sensitivity above 100 kc/s is better than 5 μ V for a 15dB signal-to-noise ratio (modulation 30% at 400 c/s).

IF Selectivity.

Three degrees of IF selectivity are provided, two of which employ crystal filters. Typical bandwidths are as follows:-

Position	Overall Bandwidth	
	-6dB	-40dB
Crystal 1*	400 c/s	6 kc/s
Crystal 2**	1.5 kc/s	6 kc/s
Wide	6 kc/s	15 kc/s

* single crystal. ** bandpass crystal.

Image Rejection.

Better than 50dB at 600 kc/s and progressively greater at lower frequencies.

IF Breakthrough.

Better than 70dB down at all frequencies.

AGC Characteristic.

The audio output level does not change by more than 10dB when the input level is increased 80dB above 10 μ V. (taken at 600 kc/s)

Audio Output and Response.

Maximum audio output to an external 2.5/3 Ω loudspeaker is approximately 1 watt. The line output is restricted to 10mW when the internal attenuator is in circuit.

The audio response is level within 6dB over the range 100 c/s to 6 kc/s. An audio filter is fitted and when this is switched into circuit a 30dB bandwidth of approximately 400 c/s is obtained centred on 1000 c/s. The 6dB bandwidth is of the order 120 c/s.

IF Output.

Approximately 100mV in 75 Ω for an input of 5 μ V at 500 kc/s with the AGC on.

Scale Calibration.

The scale calibration is directly in kilocycles and its accuracy is within 0.5% at frequencies above 100 kc/s and within 2.5% below 100 kc/s.

CIRCUIT DESCRIPTION

The RF Section.

This portion of the receiver comprises V1 and V2 and is built upon a diecast aluminium chassis provided with screened compartments which serve to house the RF, Mixer and Local Oscillator coils.

V1 (6BA6) is towards the rear of the chassis and functions as the RF Amplifier. This stage operates with automatic and/or manual gain control, the latter being effected by the variable resistor (RV1) in the cathode circuit. A small bleed current taken from the HT rail via R7 is used to extend the range of sensitivity adjustment provided by RV1. The earthy end of the gain control is taken to chassis via a 47,000 Ω resistor (R57) and a pair of terminals connected to either side of this resistor will normally be shorted by means of a wire strap so that RV1 is directly earthed. If de-sensitising facilities are required, then the strap is removed and a switch or relay contact is wired to the two terminals. This external control should be arranged to close the circuit for normal operation and open it to introduce R57 when an associated transmitter is in operation.

AGC is shunt fed to V1 via R1 and R2 and an improved AGC characteristic is obtained by feeding the screen of V1 from the potential divider R4/R5.

All input coils have tapped primary windings which allow connection of aerial feeders of either 300 or 75 Ω impedance. The earthy ends of the primaries are grounded externally by a link on the aerial panel and this can be easily removed when a balanced input is required. C11 functions as an aerial trimmer and provides a means of resonating the input circuit when using aerials having feed impedances which differ widely from 75 or 300 Ω . Range switching is achieved by means of S1a-c and it will be noted that all coils are short circuited when not actually in use.

Incorporated in the cathode circuit of the RF Stage is the tuned circuit L7/C15. This is tuned to the IF of 720 kc/s and serves to improve the IF breakthrough characteristic when using the higher frequencies in the tuning range.

Tuned secondary transformer coupling is used between the RF Stage and the heptode portion of V2 (6AJ8) which functions as the Mixer. Damped primaries are used on certain ranges to maintain accurate tracking. Range switching is handled by S1d and S1e, both of which have contacts arranged to short all coils except the one selected.

The Mixer Stage operates with fixed bias (R14) and without AGC. The screen supply is derived from the 150V stabilised HT line (HT2).

The triode portion of V2 operates as a tuned-anode oscillator and is coupled to the Mixer Stage (g_3) via C102. Range switching is by S1g and S1h, unused coils are shorted as before and the anode is fed from the HT2 supply.

Some measure of temperature compensation is achieved by the ceramic capacitor C98 which is connected directly across the tuning capacitor on all ranges.

The IF/AF Section.

IF output from the Mixer Stage is coupled via the 1st IF Transformer T1 to the Selectivity Switch S2. The secondary winding of T1 is balanced by the series connected capacitors C37 and C38 to provide a suitable input for the two crystal filters. Both filters have pre-set phasing capacitors and are phased to provide symmetrical responses. Each has its own individual output circuit (T2 and T3) and the switching is arranged so that all unused elements are earthed to prevent stray excitation of the crystals when these are not in use. When the Selectivity Switch is set to 'WIDE' the output from T1 is taken direct to the grid of the 1st IF Amplifier via the coupling capacitor C46

Two stages of IF amplification are employed, both of which use vari-mu pentodes of the 6BA6 type. AGC is shunt fed to the first stage and series fed to the second. Manual gain control is restricted to V3 and is achieved by the variable resistor RV2 in the cathode circuit. As in the case of the RF Gain control, a bleed current is introduced (via R19) and the control is returned via the desensitising circuit to further reduce the overall sensitivity when an associated transmitter is in use. The overall gain is reduced slightly on Ranges 5 and 6 by R22a (shorted by S1f on all other ranges) which is wired in series with the cathode return of V3. This simple precaution precludes the possibility of instability which might otherwise occur due to the higher gain which obtains on the two low frequency ranges.

Variation in the screen current of V4 due to AGC action is utilised to operate the Carrier Level Meter (M1). This is wired in series with the diode V5A ($\frac{1}{2}$ 6AL5) and connected to a tap on the screen feed of V4. The voltage across R26 in the absence of a signal is balanced by the voltage at the slider of RV3 so that the meter reads zero under 'no-signal' conditions. On receipt of a signal, the voltage across R26 decreases to unbalance the bridge network and causes the meter to read. The diode prevents possible damage to the meter due to reverse current when adjusting RV3.

The final IF Stage feeds V6, the two diodes of V7 and the CW Detector V9.

V6 is a triode connected pentode (6AU6) which functions as a cathode follower to provide an unrectified IF output at 720 kc/s. The output is available at a coaxial socket at the rear of the set and may be terminated in any load in the range 75-300Ω.

The first diode of V7 is used as a conventional series connected AM Detector. V5B ($\frac{1}{2}$ 6AL5) is incorporated in this circuit and functions as a series type noise limiter which can be taken out of circuit by means of S4 when not required. Output from the Detector is taken via the appropriate position of the Mode switch (S5a) and the coupling capacitor (C63) direct to the AF Gain control RV4.

The other diode of V7 is fed direct from the anode of V4 and serves as the AGC Rectifier. AGC is delayed by the voltage drop across R42 and R43, the greater proportion of the voltage appearing across R43 which forms the lower part of the voltage divider R39/R43 across the main HT supply. A delay voltage of approximately 22V is obtained.

AGC is applied to the RF Stage and both IF Stages, and the line is also brought out to a terminal at the rear for use in a diversity system. The AGC line is earthed by S3 when not required.

The CW Detector is fed from the secondary of the last IF Transformer (T5) through the coupling capacitor C68. The unit is housed in a small screening can with the valve mounted on top. Output is taken through an RF filter to the appropriate position on the Mode switch (S5a) and thence to the AF Gain control RV4. S5 is a toggle switch (DPDT) and the other section (S5b) applies stabilised HT to the screen of V9 when the 'CW' mode is selected.

The triode portion of V7 (6AT6) is the 1st Audio Stage and is resistance-capacity coupled to the Audio Output Stage V8, either direct or via the audio filter T6.

The output stage (6AM5) provides outputs for connection to telephones, loudspeaker and lines. The circuit is arranged so that insertion of the telephone plug interrupts the loudspeaker output by breaking the earth return from the earthy loudspeaker terminal. The line output winding (600Ω) is provided with an attenuator which can be brought into circuit by linking two terminals at the rear.

The Power Supply Section.

This portion of the receiver is of conventional design and provides two HT supplies one of which is stabilised (150V). All heaters with the exception of V5 are fed from the main 6.3V secondary, the centre-tap of which is earthed. V5 is fed from the other 6.3V winding and in this case the centre-tap is maintained at some 9V above earth by the voltage divider R67/R68. This form of feed overcomes the problem of hum in the Noise Limiter circuit and obviates the need for selection of the 6AL5 for use in this position.

CONSTRUCTIONAL DETAILS

Overall Dimensions and Weight.

Width	: 16 $\frac{7}{8}$ " (43 cm.)	Depth	: 15" (38.1 cm.)
Height	: 8 $\frac{7}{8}$ " (22.5 cm.)	Weight	: 50 lb. (22.6 kg.)

Cabinet.

The type of cabinet fitted to the 850/2 depends on the method of mounting which is to be employed. Cabinets are available for rack or table mounting. Both types are basically the same but the rack mounting version has cut-outs along the leading edges of the vertical sides. These cut-outs extend approximately $\frac{1}{2}$ " back from the panel and give clearance for the two angled brackets which are attached to the rear of the panel to allow the receiver to be mounted in a rack. The brackets are provided with fixing slots which conform to the Post Office standard for racks of 19" width.

Either form of cabinet has extensive perforation (in the sides, base and rear) to ensure adequate ventilation. Three apertures at the rear allow

access to the various terminals, sockets etc. Cabinets are made of steel, suitably rust-proofed and sprayed grey enamel.

Front Panel.

The front panel is an aluminium diecasting, attached to the rear of which are two chassis end plates. All controls are located for operating convenience along the lower half of the panel and their functions are indicated on a clearly marked finger plate. Chromium plated panel handles are fitted for convenience in lifting the receiver and these also allow it to be placed face-down without damage to the panel controls when the cabinet is removed to allow servicing to be carried out.

Chassis Assembly.

Three separate sub-chassis make up the complete chassis assembly. The central unit is a diecast box which is divided up into sections and provided (on the underside) with an aluminium cover plate. This unit houses all the tuned circuits associated with the RF Section and is firmly attached to four large lugs which protrude from the rear of the front panel.

The other units are the Power Unit chassis and the IF/AF chassis. The latter is made from brass and is mounted on the right-hand side of the central RF Section to which it is attached by four 2BA screws. The IF/AF chassis is also bolted to the right-hand chassis endplate which is attached to the front panel with the two screws which retain the panel handle. In the same relative position but to the left of the central RF Section is the Power Unit chassis. This is of steel and employs the same fixing arrangements as the IF/AF chassis. In addition to the power supply circuits, this chassis also carries the CW Detector Unit.

All three sub-units are supported at the rear by a narrow back plate which extends the full width of the receiver and is screwed to the chassis endplates.

Dial and Drive Assembly.

The main tuning control drives a spring-loaded split-gear system having a reduction ratio of approximately 140-1. The drive is flywheel loaded, substantially free from backlash and ensures a consistent degree of re-setting accuracy. Pointer travel is some 13" across clearly marked scales which are calibrated directly in kilocycles. A vernier dial used in conjunction with a horizontal logging scale subdivides the pointer travel into 2300 arbitrary divisions for scale logging purposes.

INSTALLATION

MOUNTING

Unless otherwise stipulated, the Model 850/2 is supplied complete with cabinet suitable for table mounting only. An interchangeable cabinet is available to special order and this has slots to clear the angled brackets which allow the receiver to be fitted in a standard size rack. The fixing slots conform to the Post Office standard for racks of 19" width.

If the receiver is to be table mounted, it may be advantageous in certain situations to have it firmly bolted to the operating table. Fixing plates are available for this purpose and may be ordered separately under the part number 5344P. Two plates are required and these are supplied complete with fixing screws.

EXTERNAL CONNECTIONS

Mains.

The AC mains supply is connected to the polarised socket at the rear using the mains connector provided with the receiver. The lead is left free at one end so that the user can fit a plug of a type suitable for connection to the local mains supply. The connecting lead is colour coded as follows:-

RED : Live line BLACK : Neutral line GREEN : Earth

NOTE: Before connecting to the local mains supply, check that the mains transformer is adjusted for the appropriate supply voltage. See 'Mains Voltage Adjustment' later in this Section.

Aerial.

Aerial feed impedances of either 75 or 300Ω can be accommodated as follows:-

75Ω balanced	. .	feeder to terminals 1 & 4.
75Ω unbalanced	. .	feeder to terminals 1 & 4 and link between terminals 1 & 3.
300Ω balanced	. .	feeder to terminals 1 & 2*.
300Ω unbalanced	. .	feeder to terminals 1 & 2 and link between terminals 1 & 3.

* link 3 & 4 for centre-tapped earth.

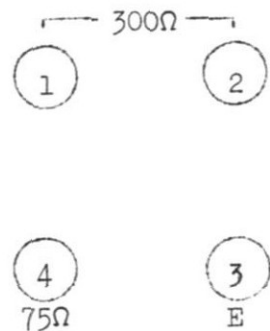

Random wire lengths should be connected to terminal 2 with a link in position between terminals 1 and 3.

Earth.

Although the receiver chassis may be earthed by virtue of the connection to the 'supply earth', it may be desirable to connect a more direct earth. This should be attached to terminal 3 above and the connecting lead should be

ERRATUM. Page 20. C97 should read 80pF. Value is correct on Circuit.

of heavy gauge and as short as conveniently possible. When the receiver is powered from a source which includes an earth leakage trip, a check should be made to see that the operation of this device is not affected by the direct earth connection.

Loudspeaker.

Connection should be made to the two quick-release terminals labelled 2.5 Ω . The right-hand terminal - looking at the rear of the set - is the earthy side of the output.

The output is suitable for any 2.5/3 Ω speaker unit and the EDDYSTONE Cat. Nos. 688 and 899 are suggested as suitable types for use in any communications installation. Reference should be made to Data Sheet No. DS 123 which is available on request for information on these units.

Telephones.

The output impedance at the telephone socket is nominally 2000 Ω but the circuit arrangements are such that telephones of almost any impedance can be used with satisfactory results. Telephones are connected at the socket on the left-hand side of the panel and the circuit is arranged so that insertion of the telephone plug interrupts the loudspeaker output. The 600 Ω output is unaffected when telephones are in use.

Line Output.

This output (marked 600 Ω) can be taken at either high or low level dependent on whether or not the link is connected between the two right-hand terminals. Low level output is obtained when the link is connected and reference to the Circuit Diagram will show how connection of the link introduces the line output attenuator.

Desensitising.

NOTE: IT IS ESSENTIAL THAT THE TWO TERMINALS MARKED 'EXTERNAL RELAY' ARE SHORTED TOGETHER BY MEANS OF A WIRE STRAP WHEN THE DESENSITISING FACILITY IS NOT REQUIRED.

When the Model 850/2 is used in close proximity to an associated transmitter, it will be necessary to desensitise the receiver during transmission periods to prevent overload, feedback etc. A relay contact wired across the desensitising terminals (lower terminal is earthy) should be arranged to close during reception periods and open when transmitting.

With this arrangement, monitoring of the outgoing transmission will not be possible. If monitoring is considered desirable it will be necessary to have some control over the level to which the receiver is desensitised. This can be arranged quite simply by connecting a 50,000 Ω variable resistor across the desensitising terminals. The variable resistor will function as a combined RF/IF Gain control and allow a wide adjustment of the sensitivity. If the transmitter is rated at more than 250 watts output a further relay should be arranged to short down the aerial input to prevent possible damage to the aerial coils.

AGC.

When two 850/2 receivers are operated in diversity, their AGC terminals should be strapped together with screened connecting wire. The braid can be conveniently earthed at the earth terminals at the right of the AGC terminals.

IF Output.

Connections should be made to the standard coaxial socket by using a coaxial lead wired to a Belling Lee coaxial plug type L.734. The cable should be terminated in a resistive load of between 75 and 300Ω.

MAINS VOLTAGE ADJUSTMENT

This adjustment will be found on the side of the mains transformer and takes the form of a 'three-way' polarised socket together with an associated shorting plug. When despatched, the plug is set in the 230V position which is suitable for AC mains voltages in the range 220-250V.

For other voltages the plug should be set as follows:-

100-125V	110V position.
200-220V	200V position.

UNDER NO CIRCUMSTANCES SHOULD THE RECEIVER BE CONNECTED TO A DC SUPPLY

OPERATION

CONTROL FUNCTIONS

Tuning.

This control is conveniently positioned to the right of centre and alters the setting of the RF Section tuning capacitors and also the pointer on the main tuning scale. Ease of tuning is assured by the large control knob which operates a flywheel loaded drive having a reduction ratio of approximately 140 : 1.

Wavechange Switch.

Selects the appropriate inductances for the range in use. All disused coils are short-circuited to prevent absorption effects. Range indication is provided by means of suitable marking on the finger plate concentric with the control knob.

Aerial Trimmer.

Provides a means of correctly resonating the aerial input circuit when using aerials of impedances differing widely from 75 or 300Ω. The control should always be adjusted for maximum signal or background hiss.

Gain Controls.

Three independent gain controls are provided as follows:-

RF Gain (RV1)	controls V1.	.
IF Gain (RV2)	controls V3.	
AF Gain (RV4)	controls level of	
		audio input to V7.	

The RF and IF Gains are operated by means of concentric control knobs. The RF control is the one with a red index line.

Signal Mode Switch.

Selects audio output from the appropriate detector for CW or AM reception. HT is removed from the screen of the CW Detector when receiving AM signals.

BFO (Pitch) Control.

Varies the pitch of the audio beat when receiving CW signals. The control can be set so that the injected frequency from the oscillator lies on either side of the IF passband so providing a means of 'single-signal' CW reception with attenuation of either the HF or LF adjacent channel as required.

Selectivity Switch.

Selects the appropriate crystal filter as required. CRYSTAL 1 position provides a 6dB bandwidth of 400 c/s and the CRYSTAL 2 position 1.5 kc/s. In the WIDE position the 6dB bandwidth is 6 kc/s.

AGC Switch.

Earths the AGC line when using manual gain control.

Noise Limiter Switch.

Introduces an efficient series type noise limiter to reduce impulse noise during AM reception. The limiter is not operative when receiving CW signals.

AF Filter Switch.

Brings into circuit a selective ferrite filter for CW reception under conditions of severe adjacent channel interference.

A 30dB bandwidth of the order 400 c/s obtains when the filter is in circuit. (6dB bandwidth : 120 c/s). Care should be taken to adjust the BFO Pitch control to provide a 1000 c/s beat when the signal is centred in the IF passband.

Mains Switch.

A double pole switch which breaks both sides of the mains supply to the mains transformer when the receiver is switched off.

TUNING INSTRUCTIONS

Ascertain that a suitable aerial is connected to the aerial terminals at the rear and check that all other external connections are made correctly.

Switch on at the Mains switch (left-hand side of panel) and, while the receiver is warming up, select the appropriate range and tune approximately to the desired frequency.

NOTE: If working on Ranges 1-4, the Selectivity switch can be set to WIDE for initial tuning, but if the desired frequency is on Ranges 5 or 6 the CRYSTAL 2 position should be used to avoid misleading effects due to the receiver local oscillator being within the IF passband on these ranges when the IF circuits are in their most unselective condition. This effect does not occur on Ranges 1-4 since the oscillator is well outside the IF range.

Now select the type of reception required (Mode switch labelled AM/CW), and after setting the gain controls to suit the type of reception and conditions prevailing, check that the aerial trimmer is peaked for maximum signal or background noise. Tune accurately to the required station and make any re-adjustments to control settings as required.

AGC can be switched on at the switch at the right-hand side of the panel and under this condition the RF and IF Gains should be fully advanced to secure maximum AGC action. Impulse noise, static crashes etc. can be reduced in strength if the noise limiter is switched into circuit. In the CW position of the Mode switch the AM pulse limiter is not in circuit but a considerable measure of noise reduction obtains due to the particular type of detection which is employed.

Selectivity can be adjusted as dictated by the interference which is present and the audio filter can be used to supplement the IF selectivity when taking CW signals suffering from severe adjacent channel interference.

ADJUSTING THE METER-ZERO CONTROL

The Carrier Level Meter operates from the AGC line and is zeroed with the AGC switched off. The zero control is located at the rear of the receiver on the left-hand side.

RE-ALIGNMENT

RE-ALIGNMENT OF THE IF SECTION AND BFO

Test equipment required Signal Generator covering 720 kc/s and a Valve
..... Voltmeter (f.s.d. 1V).

Switch on the receiver, signal generator and valve voltmeter and allow half an hour to reach operating temperature. Set the receiver controls as follows:-

Range Switch	Range 1.
Selectivity Switch	Crystal 1.
Mode Switch	AM.
IF Gain	Maximum.
AGC.	Off.

Connect the output lead from the signal generator to the stator of the centre section of the main tuning gang (i.e. to the grid of V2A). The valve voltmeter should be connected to the IF Output socket. If a valve voltmeter is not available, the built-in carrier level meter can be used (AGC must be ON) but the indication will be inferior to that obtained with the valve voltmeter.

When the equipment has reached operating temperature, set the signal generator to approximately 720 kc/s and tune slowly across the IF passband, observing the reading on the valve voltmeter. Adjust the signal generator carefully so that the signal lies on the peak of the crystal and then trim the cores in T1, T2, T4 and T5 for maximum reading on the valve voltmeter. The output level should be kept below some 500mV by adjustment of the attenuator on the signal generator.

It should be noted that T4 is slightly overcoupled and it will therefore be necessary to damp this transformer to obtain correct alignment. A 4,700 Ω resistor in series with a 0.01 μ F capacitor will make a convenient damping arrangement since one end of the combination can be directly earthed and the other end connected directly to the grid of V4 (pin 1) while adjusting the primary winding (bottom core) and to the anode of V3 (pin 5) while adjusting the grid winding.

Having aligned all transformers accurately to the centre frequency, again swing the generator tuning slowly across the IF passband and check on the symmetry of the response. If the response is at all asymmetrical this will be revealed most clearly by the presence of a rejection notch due to the crystal phasing capacitor (C43) being set incorrectly. This capacitor is accessible on the side of T2 nearest to the central RF Section and can be adjusted with a small tommy bar slipped into one of the holes in the spindle extension which protrudes through the side of the can. C43 is adjusted, first slightly in one direction and then in the other to determine which way the capacitor must go to eliminate the rejection notch. Once the correct direction has been determined adjust C43 by very small increments until the notch disappears. A check should be made to see that the notch does not re-appear on the other side of the response. T2 may now require slight re-adjustment and it is advisable to check the response again after trimming this core to ensure that the filter is still phased correctly. Any further adjustment of C43 will be very small indeed and will ensure a perfectly symmetrical response.

Leave the generator set to the crystal peak and switch to 'Crystal 2'. With the generator set to this frequency, adjust the core in T3 for greatest reading on the meter. Again tune across the IF response and make a careful check on the symmetry. Misalignment of the phasing capacitor (C39) will be shown by the presence of minor side lobes and rejection notches on either side of the response. If these are in evidence, C39 should be adjusted to eliminate them and under this condition a symmetrical response should be obtained.

NOTE: C39 is adjustable through a trimming aperture in the side plate.

Slight re-adjustment of the core in T3 may now be required to ensure that the nose of the response is reasonably flat.

This completes the alignment of the IF Stages since no further adjustment is called for in the 'Wide' position.

Now switch back to 'Crystal 1'. Set the generator to the crystal peak and then place the Mode switch at CW. Adjust the BFO control knob so that the white index mark lies at 12 o'clock, check that the capacitor is at half-capacity and then trim the core in L20 (underside of BFO Unit) to obtain zero-beat. A final check should now be made to see that the correct swing of 3 kc/s to either side of centre can be obtained.

CHECKING IF SENSITIVITY

Set the receiver controls as follows and connect the signal generator to the stator of the centre section of the main tuning gang.

Range Switch	, . . .	Range 1.
Selectivity Switch	Wide.
Mode Switch	AM.
IF and AF Gains	Maximum.
AGC and NL	Off.
Audio Filter	Out.

Connect an output meter matched to $2,5/3\Omega$ to the external loudspeaker terminals and check that the attenuator link at the 600Ω terminals is out of position.

Tune the generator to 720 kc/s (modulation 30% at 400 c/s) and adjust the attenuator for a reading of 50mW on the output meter. An average sensitivity of $16\mu\text{V}$ should be obtained.

If the sensitivity appears to be low, further checks can be made with the generator connected in turn to the grids of V3 and V4. Sensitivities of the order $180\mu\text{V}$ and 22mV should be obtained for an output of 50mW.

RE-ALIGNMENT OF THE IF REJECTOR

With the receiver adjusted as for IF alignment, transfer the signal generator output lead to the 75Ω aerial input terminals. Increase the RF Gain and adjust the signal generator (tuned to 720 kc/s) for a reading of 500mV on the valve voltmeter. Locate the trimming aperture for the IF rejector coil

(underside of RF coil box, left-hand side towards rear of receiver). Using a narrow bladed trimming tool, adjust the rejector (L7) for a minimum reading on the meter.

RE-ALIGNMENT OF THE RF SECTION

Checking Scale Calibration.

Test equipment required Crystal Calibrator providing 10 and 100 kc/s markers
 and a Signal Generator covering the range 10-40 kc/s.

Set up the receiver for CW reception with the Selectivity switch at Crystal 2 and the BFO centred in the IF passband. Allow half an hour for the equipment to reach operating temperature before commencing the check.

Select Ranges 1, 2 and 3 in turn and tune the receiver to zero-beat with each 100 kc/s calibration marker. Repeat the same procedure on Range 4 but use the 10 kc/s markers as a guide. On Ranges 5 and 6, standardise the signal generator against the 10 kc/s markers from the calibrator and then use the generator to check the scale at 5 kc/s intervals on Range 5 and at every kilocycle on Range 6.

If the calibration accuracy is within the limits 0.5% at frequencies above 100 kc/s and 2.5% below 100 kc/s there will be no need to touch the pre-set adjustments associated with the Local Oscillator Stage. Otherwise, proceed as detailed in the paragraphs which follow, adjusting only those ranges which are in error.

Re-alignment of the Local Oscillator.

Test equipment required As for checking scale calibration.

Select each range in turn and set the generator (or use the calibrator) at each of the frequencies listed in the Table below. Trim the appropriate pre-set adjustments with the receiver set accurately to the correct frequencies as indicated on the scale. Greatest accuracy will be obtained if the receiver is operated under CW conditions and all tuning adjustments are then made for zero-

Range	LOW		MIDDLE		HIGH	
	Freq.	Trim	Freq.	Trim	Freq.	Trim
1	300 kc/s	L14	-	-	550 kc/s	C79
2	150 kc/s	L15	-	-	300 kc/s	C82
3	80 kc/s	C84	110 kc/s	L16	150 kc/s	C86
4	40 kc/s	C88	55 kc/s	L17	80 kc/s	C90
5	19 kc/s	C91	27 kc/s	L18	40 kc/s	C92
6	10 kc/s	C94	15 kc/s	L19	19 kc/s	C95

beat. Each adjustment should be made several times to compensate for interaction and to ensure accurate tracking.

On Ranges 5 and 6 extra care must be taken in trimming the pre-set adjustments since quite a small movement of the series capacitor or the core will produce a considerable change in the oscillator frequency. It is possible for example to adjust Range 6 so that the oscillator tunes the range 750-760 kc/s giving an RF coverage of 20-30 kc/s. Any possible confusion will be overcome if a signal generator is available to identify the appropriate markers from the crystal calibrator.

Re-alignment of the RF and Mixer Stages.

Test equipment required Signal Generator covering the range 10-600 kc/s (75Ω output) and an Output Meter matched to 2.5/3Ω.

Select each range in turn and tune both the receiver and generator (modulated 30%, 400 c/s* and connected to the 75Ω input terminal) to the frequencies listed in the Table below. The output meter should be connected to the two external loudspeaker terminals, the aerial trimmer (panel control) should be set at half-capacity and the appropriate trimmers and cores adjusted for maximum reading on the output meter. All adjustments should be repeated as necessary until any interaction between trimmer and core is eliminated.

* On Ranges 5 and 6 it will be necessary to switch to CW and use an unmodulated carrier for alignment. The BFO should be set to produce any convenient beat.

Range	TRIMMERS			CORES		
	Freq.	RF	Mixer	Freq.	RF	Mixer
1	300 kc/s	C1	C20	550 kc/s	L1	L8
2	150 kc/s	C3	C22	300 kc/s	L2	L9
3	80 kc/s	C5	C24	150 kc/s	L3	L10
4	40 kc/s	C7	C26	80 kc/s	L4	L11
5	19 kc/s	C9	C28	40 kc/s	L5	L12
6	10 kc/s	C10	C30	19 kc/s	L6	L13

NOTE: The dust cores in L3, 4, 10 and 11 are 'hexagon' types. All other cores except those in the Vinkor assemblies can be adjusted with a standard trimming tool. A non-magnetic tool should be used to adjust the Vinkor assemblies. (DT2047 - Mullard).

APPENDIX 'A'

TABLE OF VOLTAGE VALUES

The following Table of Voltage Values will prove useful in the event of the receiver developing a fault which necessitates carrying out voltage checks.

All readings are typical and were taken with a meter having a sensitivity of 20,000Ω/volt and an applied mains voltage of 240V. A nominal tolerance of 10% will apply to readings taken with a meter of the sensitivity quoted above and this tolerance should be increased accordingly when using meters of lower sensitivity.

Readings should be taken under 'no-signal' conditions with controls set as follows. The Desensitising terminals at the rear must be strapped together.

Range Switch Range 1.
 Mode Switch AM.
 AGC Off.
 RF/IF Gains Maximum.

Stage	Anode	Screen	Cathode
V1	235V	85V	0.92V
V2A	240V	95V	1.8V
V2B	100V*	-	1.8V
V3	240V	98V	0.72V**
V4	240V	88V	1.2V
V5A	182V	-	182V
V5B	-	-	-
V6	190V	190V	2.5V
V7	130V	-	20V
V8	248V	238V	11.3V
V9	See Note below		
V10	255V (AC)	-	280V
V11	150V	-	-

* Varies within the limits 86-100V depending on Range in use. (68V with oscillator stopped)

** 1.7V on Ranges 5 and 6 (R22a in circuit).

V9, CW Detector.

This stage is normally inaccessible for voltage checks. Supply voltages measured externally at point of connection to unit are as follows:

Anode : Red lead - 210V
 Screen : Blue lead - 137V

Electrode voltages measured at valve holder:

 Anode : 200V
 Screen : 78V
 Cathode : 1.3V

APPENDIX 'B'

LIST OF COMPONENT VALUES, TOLERANCES AND RATINGS

Capacitors.

Ref	Value	Type	Tol.	Wkg. V.
C1	3-30pF	Air Trimmer	-	-
C2	80pF	Silvered Mica	5%	350V
C3	3-30pF	Air Trimmer	-	-
C4	40pF	Silvered Mica	5%	350V
C5	3-30pF	Air Trimmer	-	-
C6	60pF	Silvered Mica	5%	350V
C7	3-30pF	Air Trimmer	-	-
C8	40pF	Silvered Mica	5%	350V
C9	3-30pF	Air Trimmer	-	-
C10	3-30pF	Air Trimmer	-	-
C11	3.5-54pF	Air Spaced Variable	-	-
C12	12.5-535pF	Three Gang Air Spaced Variable	-	-
C13	100pF	Silvered Mica	5%	350V
C14	0.25μF	Metallised Paper	20%	150V
C15	0.001μF	Polystyrene	5%	125V
C16	0.01μF	Tubular Paper	20%	150V
C17	0.25μF	Metallised Paper	20%	150V
C18	8μF	Tubular Electrolytic	-	275V
C19	0.05μF	Tubular Paper	20%	350V
C20	3-30pF	Air Trimmer	-	-
C21	80pF	Silvered Mica	5%	350V
C22	3-30pF	Air Trimmer	-	-
C23	80pF	Silvered Mica	5%	350V
C24	3-30pF	Air Trimmer	-	-
C25	80pF	Silvered Mica	5%	350V
C26	3-30pF	Air Trimmer	-	-
C27	60pF	Silvered Mica	5%	350V
C28	3-30pF	Air Trimmer	-	-
C29	20pF	Silvered Mica	5%	350V
C30	3-30pF	Air Trimmer	-	-
C31	100pF	Silvered Mica	5%	350V
C32		Not applicable.		
C33	0.25μF	Metallised Paper	20%	150V
C34	0.25μF	Metallised Paper	20%	150V
C35	0.05μF	Tubular Paper	20%	350V
C36	390pF	Polystyrene	5%	125V
C37	790pF	Polystyrene	2%	125V
C38	790pF	Polystyrene	2%	125V
C39	2-10pF	Air Trimmer (Differential)	-	-

Ref	Value	Type	Tol.	Wkg. V.
C40	50pF	Silvered Mica	5%	350V
C41	100pF	Silvered Mica	5%	350V
C42	50pF	Silvered Mica	5%	350V
C43	2-10pF	Air Trimmer	-	-
C44	100pF	Silvered Mica	5%	350V
C45	2 μ F	Metallised Paper	20%	200V
C46	100pF	Silvered Mica	5%	350V
C47	0.05 μ F	Tubular Paper	20%	350V
C48	0.05 μ F	Tubular Paper	20%	350V
C49	390pF	Polystyrene	5%	125V
C50	390pF	Polystyrene	5%	125V
C51	0.05 μ F	Tubular Paper	20%	350V
C52	0.05 μ F	Tubular Paper	20%	350V
C53	0.05 μ F	Tubular Paper	20%	350V
C54	0.05 μ F	Tubular Paper	20%	350V
C55	390pF	Polystyrene	5%	125V
C56	390pF	Polystyrene	5%	125V
C57	50pF	Tubular Ceramic	10%	350V
C58	500pF	Tubular Paper	20%	350V
C59	0.05 μ F	Tubular Paper	20%	350V
C60	0.05 μ F	Tubular Paper	20%	350V
C61	0.05 μ F	Tubular Paper	20%	350V
C62	20pF	Silvered Mica	5%	350V
C63	0.05 μ F	Tubular Paper	20%	350V
C64	0.04 μ F	Tubular Paper	20%	150V
C65	200pF	Tubular Ceramic	10%	350V
C66	0.01 μ F	Moulded Mica	20%	350V
C67	500pF	Moulded Mica	20%	350V
C68	6pF	Tubular Ceramic	$\pm 1pF$	350V
C69	25 μ F	Tubular Electrolytic	-	25V
C70	25 μ F	Tubular Electrolytic	-	25V
C71	32+32 μ F	Tubular Electrolytic	-	350V
C72	0.01 μ F	Moulded Mica	20%	350V
C73	0.007 μ F	Silvered Mica	1%	350V
C74	0.007 μ F	Silvered Mica	1%	350V
C75	0.005 μ F	Disc Ceramic	+80 -20%	900V
C76	25 μ F	Tubular Electrolytic	-	25V
C77	0.01 μ F	Moulded Mica	20%	350V
C78	330pF	Silvered Mica	1%	350V
C79	3-30pF	Air Trimmer	-	-
C80	25pF	Silvered Mica	5%	350V
C81	180pF	Silvered Mica	1%	350V
C82	3-30pF	Air Trimmer	-	-
C83	25pF	Silvered Mica	5%	350V
C84	3-30pF	Air Trimmer	-	-

Ref	Value	Type	Tol.	Wkg. V.
C85	60pF	Silvered Mica	5%	350V
C86	3-30pF	Air Trimmer	-	-
C87	20pF	Silvered Mica	5%	350V
C88	3-30pF	Air Trimmer	-	-
C89	20pF	Silvered Mica	5%	350V
C90	3-30pF	Air Trimmer	-	-
C91	3-30pF	Air Trimmer	-	-
C92	3-30pF	Air Trimmer	-	-
C93	25pF	Silvered Mica	5%	350V
C94	3-30pF	Air Trimmer	-	-
C95	3-30pF	Air Trimmer	-	-
C96	160pF	Silvered Mica	5%	350V
C97	50pF	Silvered Ceramic N750	5%	350V
C98	20pF	Silvered Ceramic N750	5%	350V
C99	100pF	Silvered Mica	5%	350V
C100	200pF	Tubular Ceramic	10%	350V
C101	0.25μF	Metallised Paper	20%	150V
C102	50pF	Tubular Ceramic	10%	350V
C103	100pF	Tubular Ceramic	10%	350V
C104	0.05μF	Tubular Paper	20%	350V
C105	500pF	Tubular Paper	20%	350V
C106	500pF	Tubular Paper	20%	350V
C107	0.01μF	Tubular Paper	20%	350V
C108	0.005μF	Tubular Ceramic	20%	350V
C109	0.001μF	Tubular Ceramic	20%	350V
C110	100pF	Silvered Mica	5%	350V
C111	30μF	Tubular Electrolytic	-	15V
C112	3.5-25pF	Air Spaced Variable	-	-
C113	0.001μF	Polystyrene	5%	125V
C114	25μF	Tubular Electrolytic	-	25V
C115	50μF	Tubular Electrolytic	-	450V
C116	0.25μF	Metallised Paper	20%	150V
C117	0.25μF	Metallised Paper	20%	150V

Resistors.

Ref	Value	Tol.	Rating	Ref	Value	Tol.	Rating
R1	0.47 Megohm	10%	$\frac{1}{2}$ watt	R6	68 ohms	10%	$\frac{1}{2}$ watt
R2	0.47 Megohm	10%	$\frac{1}{2}$ watt	R7	0.1 Megohm	10%	1 watt
R3	12 ohms	10%	$\frac{1}{2}$ watt	R8	1,000 ohms	10%	$\frac{1}{2}$ watt
R4	68,000 ohms	10%	$\frac{1}{2}$ watt	R9	470 ohms	10%	$\frac{1}{2}$ watt
R5	33,000 ohms	10%	1 watt				

Ref	Value	Tol.	Rating
R10	470 ohms	10%	$\frac{1}{2}$ watt
R11	2,200 ohms	10%	$\frac{1}{2}$ watt
R12	2,200 ohms	10%	$\frac{1}{2}$ watt
R13	0.47 Megohm	10%	$\frac{1}{2}$ watt
R14	150 ohms	10%	$\frac{1}{2}$ watt
R15	47,000 ohms	10%	$\frac{1}{2}$ watt
R16	10,000 ohms	10%	$\frac{1}{2}$ watt
R17	1,000 ohms	10%	$\frac{1}{2}$ watt
R18	0.47 Megohm	10%	$\frac{1}{2}$ watt
R19	47,000 ohms	10%	1 watt
R20	47,000 ohms	10%	1 watt
R21	1,000 ohms	10%	$\frac{1}{2}$ watt
R22	68 ohms	10%	$\frac{1}{2}$ watt
R22a	68 ohms*	10%	$\frac{1}{2}$ watt
R23	0.47 Megohm	10%	$\frac{1}{2}$ watt
R24	27,000 ohms	10%	1 watt
R25	10,000 ohms	10%	1 watt
R26	22,000 ohms	10%	1 watt
R27	27,000 ohms	10%	1 watt
R28	1,000 ohms	10%	$\frac{1}{2}$ watt
R29	100 ohms	10%	$\frac{1}{2}$ watt
R30	1 Megohm	10%	$\frac{1}{2}$ watt
R31	2.2 Megohms	10%	$\frac{1}{2}$ watt
R32	0.1 Megohm	10%	$\frac{1}{2}$ watt
R33	0.1 Megohm	10%	$\frac{1}{2}$ watt
R34	0.47 Megohm	10%	$\frac{1}{2}$ watt
R35	220 ohms	10%	$\frac{1}{2}$ watt
R36	4,700 ohms	10%	$\frac{1}{2}$ watt
R37	27,000 ohms	10%	1 watt
R38	0.27 Megohm	10%	$\frac{1}{2}$ watt
R39	0.1 Megohm	10%	$\frac{1}{2}$ watt
R40	0.47 Megohm	10%	$\frac{1}{2}$ watt
R41	0.27 Megohm	10%	$\frac{1}{2}$ watt
R42	3,300 ohms	10%	$\frac{1}{2}$ watt
R43	6,800 ohms	10%	$\frac{1}{2}$ watt
R44	10,000 ohms	10%	$\frac{1}{2}$ watt

Ref	Value	Tol.	Rating
R45	0.47 Megohm	10%	$\frac{1}{2}$ watt
R46	4,700 ohms	10%	$\frac{1}{2}$ watt
R47	680 ohms w/w	5%	3 watt
R48	2,200 ohms	10%	1 watt
R49	680 ohms	10%	$\frac{1}{2}$ watt
R50	47 ohms	10%	$\frac{1}{2}$ watt
R51	680 ohms	10%	$\frac{1}{2}$ watt
R52	33,000 ohms	10%	$\frac{1}{2}$ watt
R53	3,300 ohms	10%	$\frac{1}{2}$ watt
R54	1,000 ohms	10%	$\frac{1}{2}$ watt
R55	10,000 ohms	10%	$\frac{1}{2}$ watt
R56	47,000 ohms	10%	$\frac{1}{2}$ watt
R57	47,000 ohms	10%	1 watt
R58	0.47 Megohm	10%	$\frac{1}{2}$ watt
R59	47 ohms	10%	$\frac{1}{2}$ watt
R60	10,000 ohms	10%	$\frac{1}{2}$ watt
R61	2,200 ohms	10%	$\frac{1}{2}$ watt
R62	10,000 ohms	10%	$\frac{1}{2}$ watt
R63	47,000 ohms	10%	$\frac{1}{2}$ watt
R64	22,000 ohms	10%	$\frac{1}{2}$ watt
R65	220 ohms	10%	$\frac{1}{2}$ watt
R66	2,700 ohms**	5%	6 watt
R67	0.1 Megohm	10%	$\frac{1}{2}$ watt
R68	6,800 ohms	10%	$\frac{1}{2}$ watt

Potentiometers.

Ref	Value	Type
RV1	10,000 ohms	Wirewound
RV2	10,000 ohms	Wirewound
RV3	5,000 ohms	Wirewound
RV4	0.5 Megohm	Carbon

* Nominal value. Exact value determined during test.

** Wirewound.

NOTE: RV1 and RV2 are combined.

APPENDIX 'C'

SPARES

Inductors.

L1	Range 1 Aerial Coil	D2751
L2	Range 2 Aerial Coil	D2754
L3	Range 3 Aerial Coil	D2757
L4	Range 4 Aerial Coil	D2760
L5	Range 5 Aerial Coil	D2763
L6	Range 6 Aerial Coil	D2766
L7	720 kc/s IF Rejector Coil	D2769
L8	Range 1 Mixer Coil	D2752
L9	Range 2 Mixer Coil	D2755
L10	Range 3 Mixer Coil	D2758
L11	Range 4 Mixer Coil	D2761
L12	Range 5 Mixer Coil	D2764
L13	Range 6 Mixer Coil	D2767
L14	Range 1 Local Oscillator Coil	D2753
L15	Range 2 Local Oscillator Coil	D2756
L16	Range 3 Local Oscillator Coil	D2759
L17	Range 4 Local Oscillator Coil	D2762
L18	Range 5 Local Oscillator Coil	D2765
L19	Range 6 Local Oscillator Coil	D2768
L20	Beat Frequency Oscillator Coil	D2732

Chokes and Transformers.

CH1	Power Supply Smoothing Choke	D2049B
T1	1st 720 kc/s IF Transformer	D2770
T2*	Crystal Filter Unit 1 (single crystal)	D2773
T3*	Crystal Filter Unit 2 (dual crystal)	D2774
T4	2nd 720 kc/s IF Transformer	D2771
T5	3rd 720 kc/s IF Transformer	D2772
T6	Audio Filter	D2735
T7	Output Transformer	D1697
T8	Mains Transformer	3937P

* Supplied complete with screening can but less crystal.

Crystals. (Style 'E')

XL1	Single Crystal 720 kc/s \pm 0.05%	6121P
XL2	Dual Crystal centred 720 kc/s \pm 0.05%, spaced 1100 c/s \pm 50 c/s	6122P

Switches.

S1	Range Switch : Wafer - 1P6W with shorting plate	5011P
	Clicker Mechanism	5433P
	Extension Spindle	5431P
	Coupler	5428P
S2	Selectivity Switch : 3P3W complete	5959P
S3/4	AGC/Noise Limiter Switches : Toggle Type SPST	5789P
S5/6/7	Mode/Filter/Mains Switches : Toggle Type DPDT	5788P

Variable Capacitors and Associated Items.

C11	Aerial Trimmer	LP2125/1
	Extension spindle for Aerial Trimmer	5783/1P
	Flexible coupler for Aerial Trimmer	D2874
C12	Three-gang Tuning Capacitor	5957P
	Flexible coupler for Tuning Capacitor	D1680
C112	BFO Pitch Capacitor	D2807

Potentiometers.

RV1/2	2 x 10,000 Ω wirewound (concentric spindles)	5810P
RV3	5,000 Ω wirewound	6123P
RV4	0.5 M Ω carbon	4103PB

Knobs.

Main Tuning	3146/1P
Wavechange	D2872
RF Gain	5834P
IF Gain	5786P
Aerial Trimmer	3148/1P
Selectivity, AF Gain, BFO Pitch	4984/1P

Drive Assembly.

Condenser gear spindle assembly	D2077
Drive disc assembly	D1562/1
Vernier spindle assembly	D1559/1
Control spindle assembly	BP953

Miscellaneous.

Chromium plated panel handles	5826P
Scale plate	D2748
Pointer assembly	D2873
Pointer guide rails	5801P
Glass Window	5847P
Carrier level meter	5956/1P
Finger plate	5951P
Terminal (as used for audio output etc.)	6102P
Fuseholder	6103P
Fuses (1 Amp.)	6124P
Coaxial socket (IF Output)	6087P
Phone jack	6090P
Vernier dial (complete with hub)	D2250
Drive Pulleys	5837P
Guide Pulleys	6125P
Dial Lamps	3131P
Valve screening can (B7G)	6126P
Valve screening can (B9A)	6127P

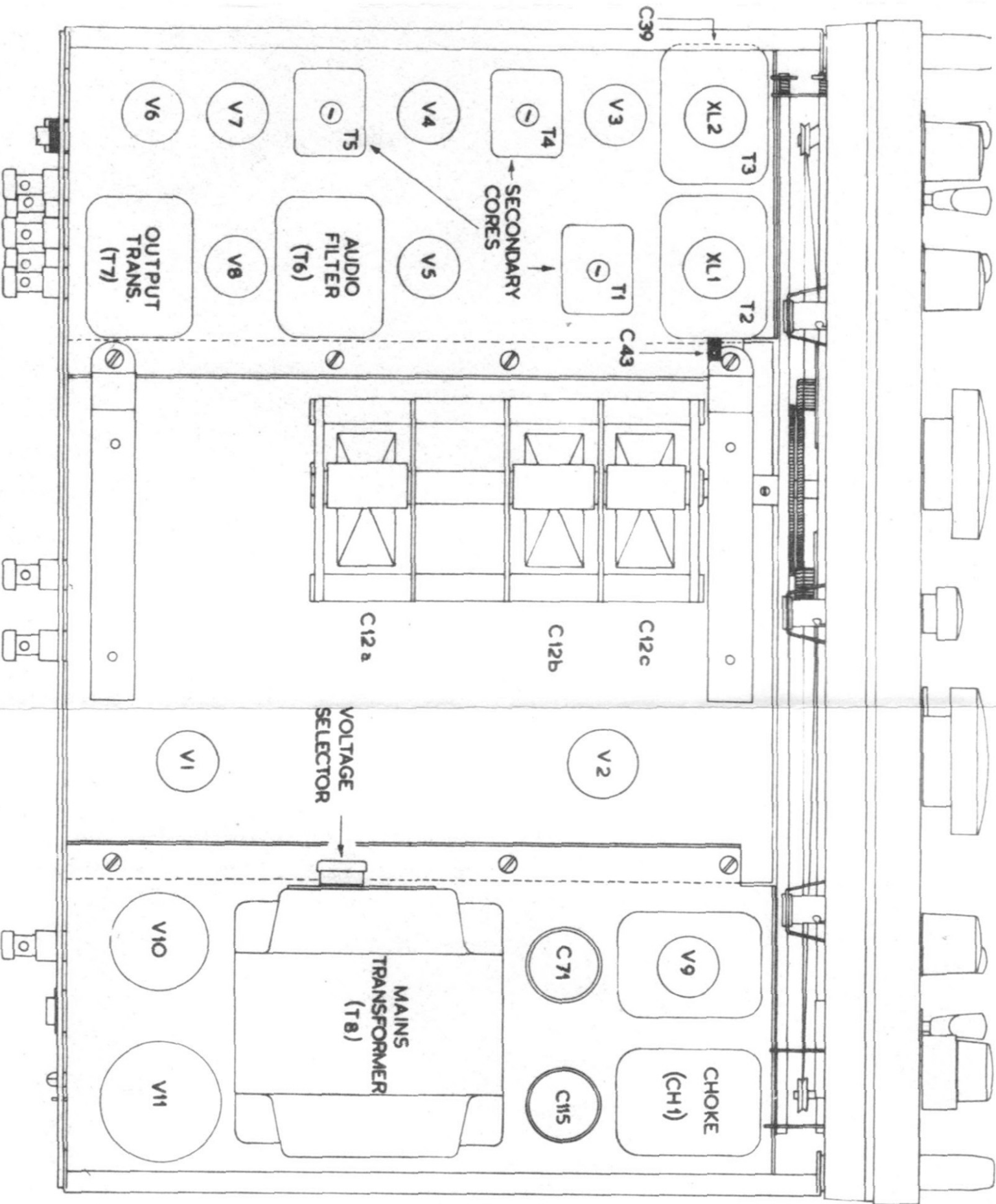

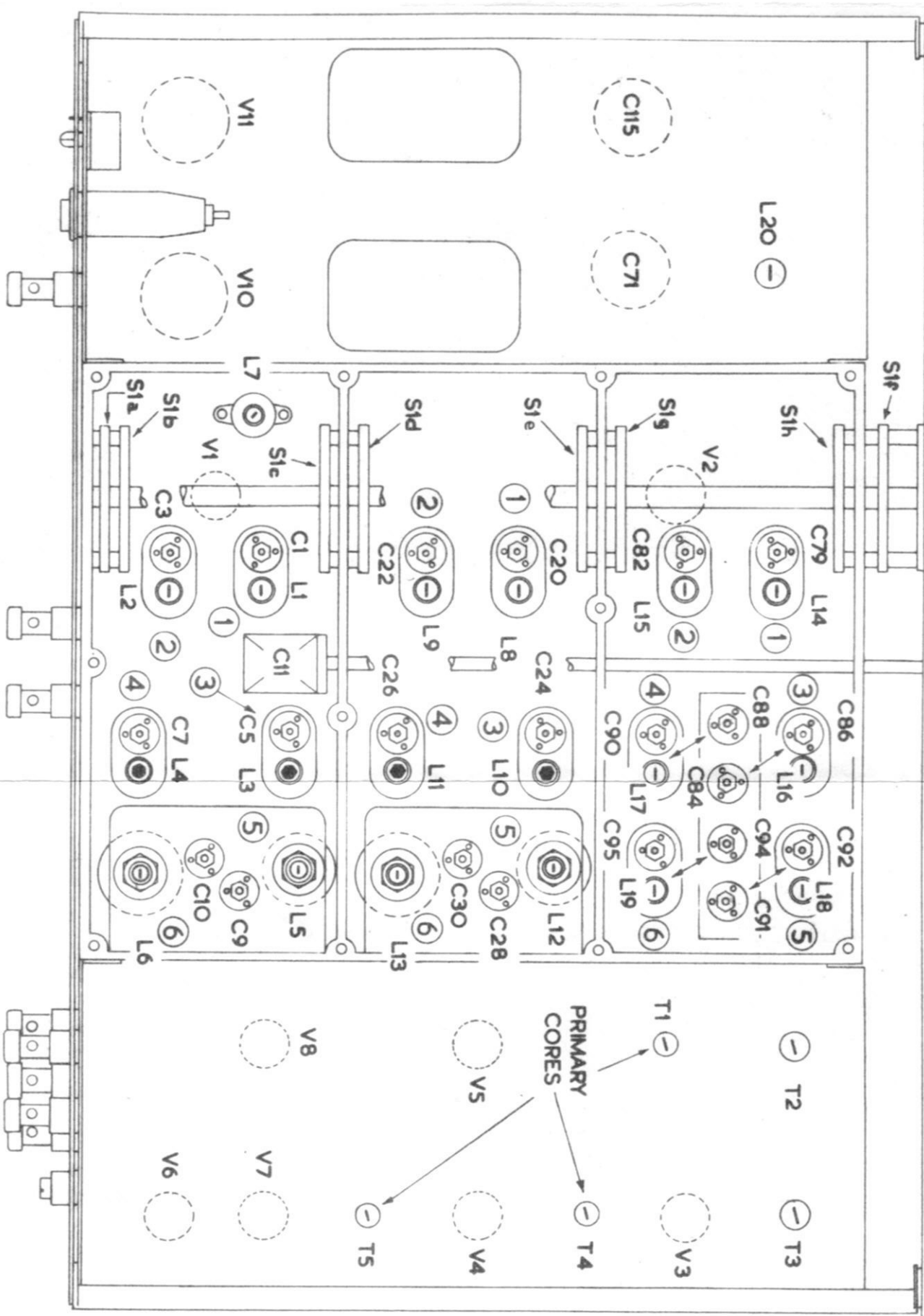

RINGED NUMBERS INDICATE RANGES

PRIMARY CORES

S1f

T1 T2 T3

V3

C115

C71

L20

V11

V10

L7

S1h

V2

C79 L14

C82 L15

C20 L8

C22 L9

C1 L1

C3 L2

C11

C7 L4

C5 L3

C26 L11

L10

C86 L16

C88 L17

C90 L17

C92 L18

C94 L19

C95 L19

C9 L5

C10 L6

C30 L13

C28 L12

V8

V5

V7

V6

T5

V4

T4

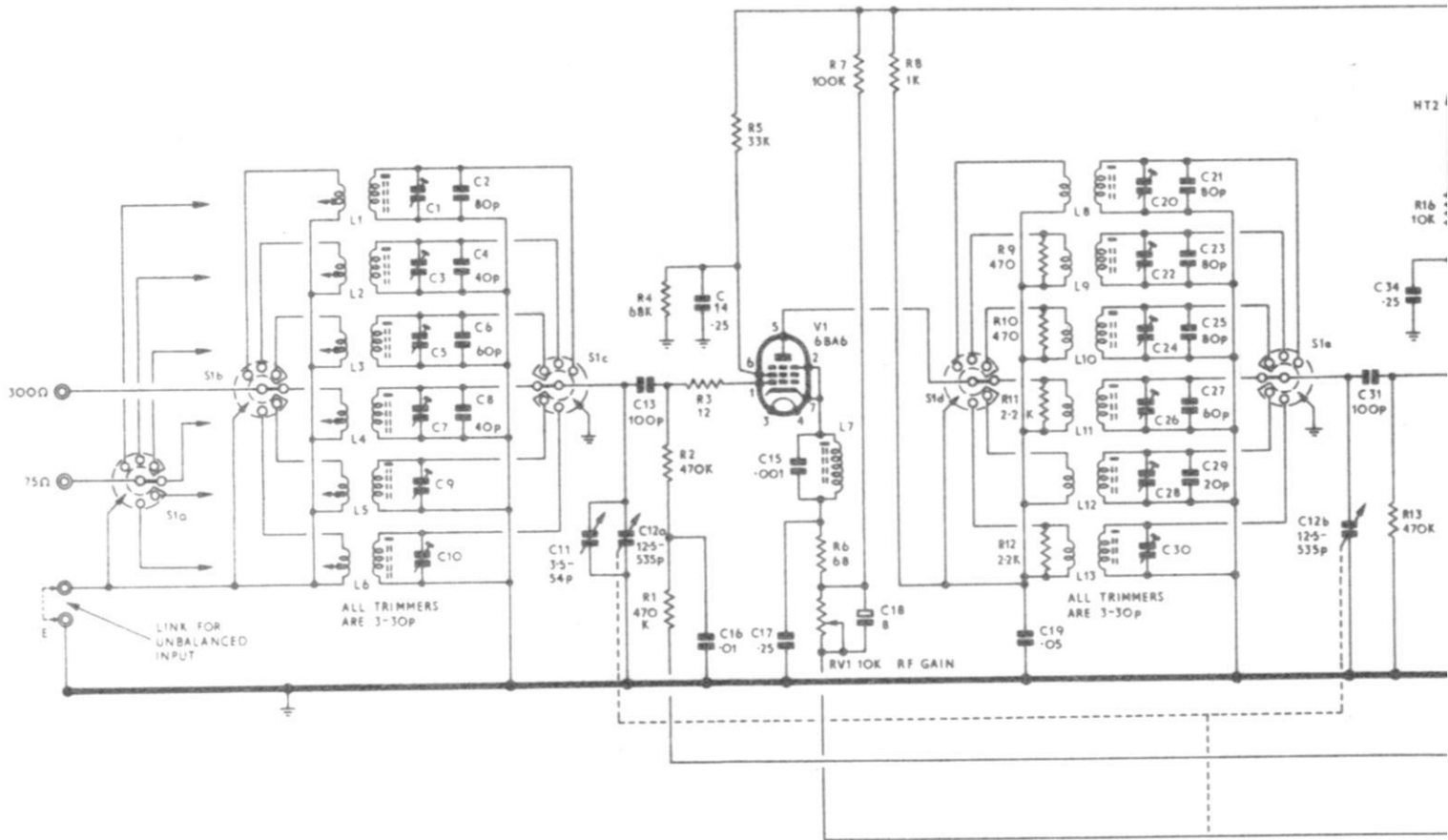

SWITCH AND CONTROL FUNCTIONS	
S1	RANGE
S2	SELECTIVITY
S3	AGC
S4	NOISE LIMITER
S5	SIGNAL MODE
S6	AUDIO FILTER
S7	MAINS
RV1	RF GAIN
RV2	IF GAIN
RV3	METER ZERO (PRE-SET)
RV4	AF GAIN
C11	AERIAL TRIMMER
C12	TUNING
C12	CW PITCH

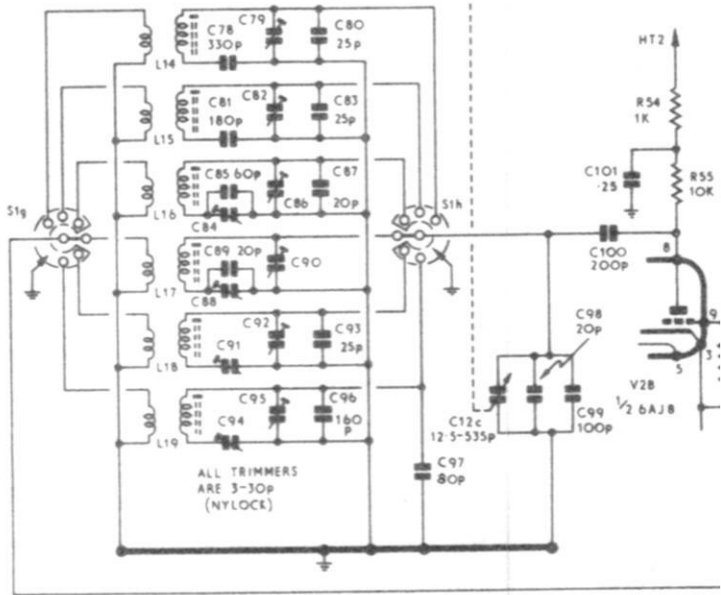
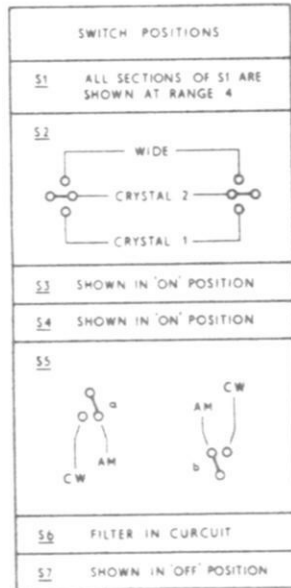

MODEL 850/2.

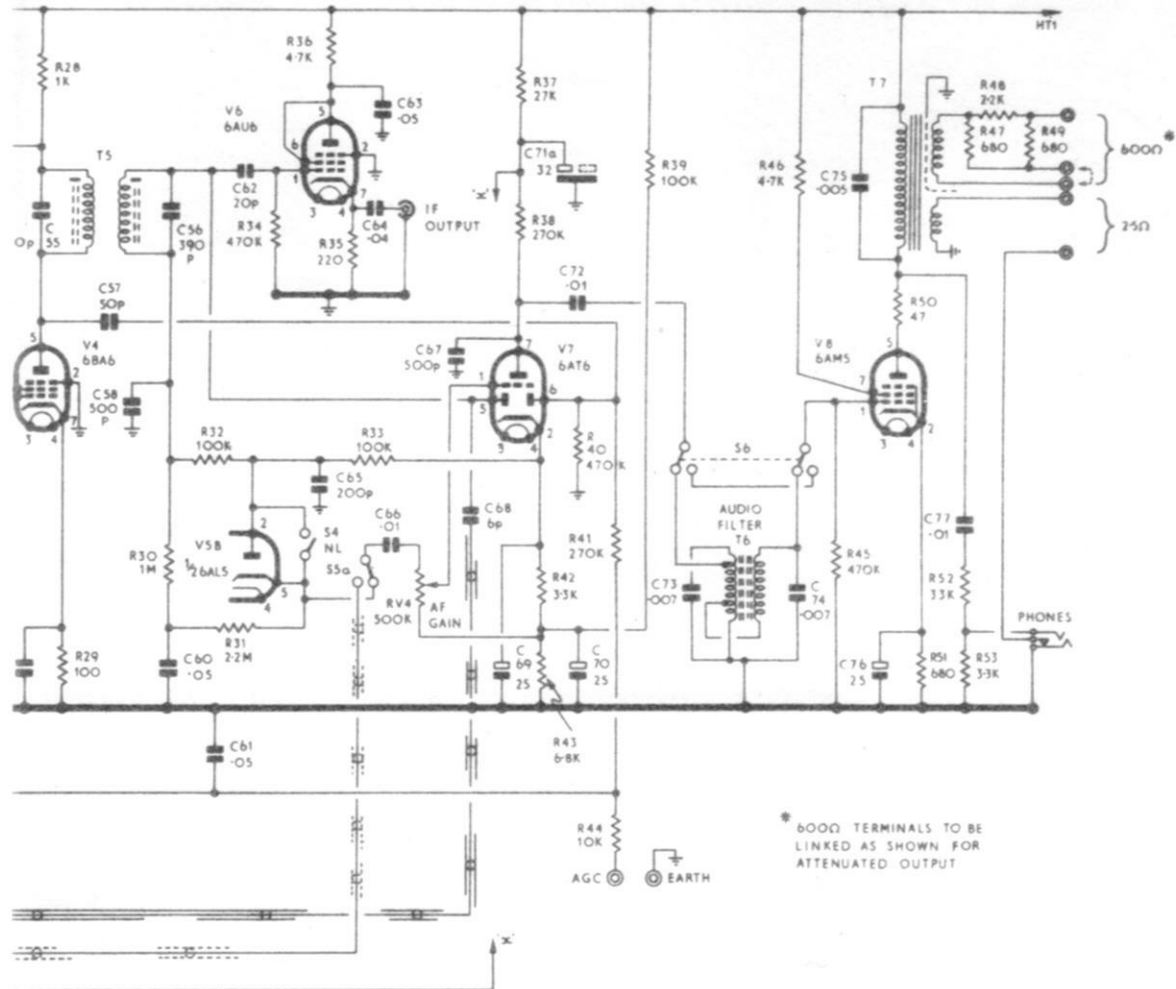

* 600Ω TERMINALS TO BE LINKED AS SHOWN FOR ATTENUATED OUTPUT

